

CN51

Mobile Computer

with Android™



User Manual

Intermec by Honeywell

6001 36th Ave.W.
Everett, WA 98203
U.S.A.

www.intermec.com

The information contained herein is provided solely for the purpose of allowing customers to operate and service Intermec-manufactured equipment and is not to be released, reproduced, or used for any other purpose without written permission of Intermec by Honeywell.

Information and specifications contained in this document are subject to change without prior notice and do not represent a commitment on the part of Intermec by Honeywell.

The word Intermec and the Intermec logo are either trademarks or registered trademarks of Intermec Technologies Corporation.

© 2014 Intermec by Honeywell. All rights reserved.

For patent information, please refer to www.hsmpats.com.

Android, Google, and other marks are trademarks of Google Inc.

Bluetooth is a trademark of Bluetooth SIG, Inc., U.S.A.

Wi-Fi is a registered certification mark of the Wi-Fi Alliance.

This product includes software developed by the OpenSSL Project for use in the OpenSSL Toolkit (www.openssl.org).

This product includes cryptographic software written by Eric Young (EAY@cryptsoft.com).

This product uses Regex++, Index software during its operational phases. The owner of Regex++ has granted use of the software to anyone provided such use is accompanied by the following copyright and permission notice:

Regex++, Index. (Version 3.31, 16th Dec 2001)

Copyright © 1998-2001 Dr John Maddock

Permission to use, copy, modify, distribute and sell this software and its documentation for any purpose is hereby granted without fee, provided that the above copyright notice appear in all copies and that both that copyright notice and this permission notice appear in supporting documentation. Dr John Maddock makes no representations about the suitability of this software for any purpose. It is provided “as is” without express or implied warranty.

Document Change Record

This page records changes to this document. The document was originally released as Revision 001.

Version Number	Date	Description of Change
002	3/2014	Revised to support Android 4.2.2.

Contents

Before You Begin.....	xi
Safety Information.....	xi
Global Services and Support.....	xi
Warranty Information.....	xi
Web Support.....	xii
Send Feedback.....	xii
Telephone Support.....	xii
Who Should Read This Manual.....	xii
Related Documents.....	xii
Patent Information.....	xiii

1 About the Computer Features 1

About the CN51 Mobile Computer.....	2
About the Battery.....	4
Charge the Battery.....	4
Change the Battery.....	5
About Battery Status.....	7
Check the Battery Level.....	8
Check the Battery Status.....	9
About Battery Life and Conservation.....	9
Enable Airplane Mode.....	10
Quickly Enable or Disable Airplane Mode.....	11
About the Status LEDs.....	12
About the Keypad.....	14
About the Color-Coded Keys.....	15
How to Capitalize Characters on the QWERTY Keypad.....	15
How to Capitalize Characters on the Numeric Keypad.....	16
About the Power Button.....	16
About the Screen Backlight.....	17
Configure the Screen Backlight Brightness.....	17
About the Audio Features.....	18
Adjust the Ringtone and Notification Volume.....	18
Enable Vibrate Mode.....	19
Audio Settings.....	20
Insert a MicroSD Card.....	21

Contents

How to Transfer Files	23
Configure the USB Connection for PTP	23
CN51 Accessories	24

2 About the User Interface and Intermec Applications 27

About the User Interface	28
About the Home Screen	28
View Notifications	29
Customize the Home Screen	30
Customize the Favorites Tray	30
Use Google™ Search	31
About Screen Gestures	31
Set the Time Zone	32
Manage Notifications	32
About Intermec Applications	33
Intermec Apps on the Computer	33

3 Use the Scanner 35

About the Scanner	36
Disable the Scanner	36
Disable the Virtual Wedge	37
Enable Symbology Decoding	38
Scan Bar Codes	39
Enable Access to URLs in Bar Codes	40
Enable Scanner Control from Web Applications	41
Use the Scan Demo App	41
How to Configure the Scanner	42
Configure Symbology Decoding Options	42
Australia Post Settings	44
Aztec Settings	44
BPO Settings	45
Canada Post Settings	45
Codabar Settings	46
Codablock A Settings	47
Codablock F Settings	48

Code 11 Settings	48
Code 39 Settings	49
Code 93 Settings	51
Code 128/GS1-128 Settings	52
Datamatrix Settings	53
Dutch Post Settings	54
EAN/UPC Settings	54
GS1 Composite Settings	57
GS1 DataBar Expanded Settings	58
GS1 DataBar Limited Settings	59
GS1 DataBar Omni-Directional Settings	59
Han Xin Settings	60
Infomail Settings	60
Intelligent Mail Settings	61
Interleaved 2 of 5 Settings	61
Japan Post Settings	62
Matrix 2 of 5 Settings	63
Maxicode Settings	64
Micro PDF417 Settings	64
MSI Settings	65
PDF417 Settings	66
Planet Settings	67
Plessey Settings	67
Postnet Settings	68
QR Code Settings	69
Standard 2 of 5 Settings	70
Sweden Post Settings	71
Telepen Settings	71
TLC 39 Settings	72
Configure the Scanner Decode Security Settings	73
Decode Security Settings	74
Set a Preamble, Postamble, or Symbology Identifier	75
Set the Scanner Trigger or Aimer Mode	76
Scanner Settings	76

4 Use the Phone 79

About the Phone	80
Activate the UMTS Phone	81
Activate the CDMA Phone	83
Make a Phone Call	84

Contents

Answer the Phone	85
Send a Call to Voicemail	85
Switch Apps During a Phone Call	85
Check Your Voicemail	86
Set Your Voicemail Number	86
Change Voicemail Settings	86
Make an Emergency Phone Call	87
Switch Between Network Carriers	87
About Internet Calling	88
Set Up Internet Calling	88
Add Contacts for Internet Calling	88
Configure Phone Settings	89
Phone Settings	89
5 Use the Camera	91
About the Color Camera	92
Take a Picture	92
Change Camera Settings for Taking Pictures	92
Record a Video	94
Change Video Settings	94
6 Configure the Computer	95
How to Configure the Computer	96
Start the Settings App	96
About the Structure of the Settings App	96
About Network Communications	99
Connect to a Wi-Fi Network	99
Configure Proxy Settings for a Wi-Fi Network	101
Disable Wi-Fi Notifications	102
Connect to an Ethernet Network	102

How to Connect to Virtual Private Networks	103
Add a VPN	103
Connect to a VPN	103
Edit VPN Information	104
About Wireless Security	104
Configure Wireless Security	105
About Certificates	105
Load a Certificate	105
Disable or Remove Certificates	106
About Bluetooth Communications	106
Connect a Bluetooth Device	107
Configure Bluetooth Settings	108
Rename or Disconnect a Paired Device	109
View a List of Received Files	109
About Serial and USB Communications	109
How to Share Your Mobile Data Connection	110
Share the Data Connection Through USB	110
Share the Data Connection Through Bluetooth	110
Share the Data Connection as a Portable Hotspot	111

7 Manage the Computer 113

How to Transfer Files	114
Connect to a PC through USB	114
Configure the USB Connection for PTP	114
How to Develop and Install Applications	115
Download the Intermec SDKs for Android	116
Install the Intermec CN51 SDK Add-on with the SDK Manager	116
How to Set Up the Mobile Computer for App Development	119
Enable Developer Options	119
How to Update the System Software	120
Update Computers Using a Device Management System	120
Update the System Software	120

8 Troubleshoot and Maintain the Computer 123

About Troubleshooting the Computer	124
Wi-Fi Connection Problems.....	124
802.1x Security Problems	125
Problems Reading Bar Codes.....	127
Problems Using the Computer	129
Call Product Support.....	130
Locate the Build Version and Configuration String Using the Settings App ..	130
Locate the Configuration String in the Battery Compartment	131
Reset the Computer	132
Perform a Factory Data Reset	132
Clean the Computer.....	133

A Specifications 135

Physical and Environmental Specifications.....	136
EA31 Extended Reading Range.....	138
EA31 Minimum Reading Distances.....	139
EA31 Typical Reading Distances	140
EA30 Extended Reading Range.....	142
EA30 Minimum Reading Distances.....	143
EA30 Typical Reading Distances	144

B Default Settings 147

Wireless and Network Settings	148
Scanner Settings	148
Device Settings	151
Personal Settings.....	152
System Settings.....	153

Before You Begin

This section provides you with safety information, technical support information, and sources for additional product information.

Safety Information

Your safety is extremely important. Read and follow all warnings and cautions in this document before handling and operating Intermec equipment. You can be seriously injured, and equipment and data can be damaged if you do not follow the safety warnings and cautions.

This section explains how to identify and understand dangers, warnings, cautions, and notes that are in this document. You may also see icons that tell you when to follow ESD procedures and when to take special precautions for handling optical parts.



Caution: A caution alerts you to an operating procedure, practice, condition, or statement that must be strictly observed to prevent equipment damage or destruction, or corruption or loss of data.



Note: Notes either provide extra information about a topic or contain special instructions for handling a particular condition or set of circumstances.

Global Services and Support

Warranty Information

To understand the warranty for your Intermec product, visit the Intermec website at www.intermec.com and click **Support > Returns and Repairs > Warranty**.

Disclaimer of warranties: The sample code included in this document is presented for reference only. The code does not necessarily represent complete, tested programs. The code is provided “as is with all faults.” All warranties are expressly disclaimed, including the implied warranties of merchantability and fitness for a particular purpose.

Web Support

Visit the Intermec website at www.intermec.com to download our current manuals (in PDF).

Visit the Intermec technical knowledge base (Knowledge Central) at www.intermec.com and click **Support > Knowledge Central** to review technical information or to request technical support for your Intermec product.

Send Feedback

Your feedback is crucial to the continual improvement of our documentation. To provide feedback about this manual, please contact the Intermec Technical Communications department directly at TechnicalCommunications@intermec.com.

Telephone Support

In the U.S.A. and Canada, call **1-800-755-5505**.

Outside the U.S.A. and Canada, contact your local Intermec representative. To search for your local representative, from the Intermec website, click **About Us > Contact Us**.

Who Should Read This Manual

This user manual is for the person who is responsible for installing, configuring, and maintaining the CN51.

This document provides you with information about the features of the CN51, and how to install, configure, operate, maintain, and troubleshoot it.

Before you work with the CN51, you should be familiar with your network and general networking terms, such as IP address.

Related Documents

The Intermec website at www.intermec.com contains our documents (as .pdf files) that you can download for free.

To download documents

- 1** Visit the Intermec website at www.intermec.com.
- 2** Click the **Products** tab.

3 Using the **Products** menu, navigate to your product page. For example, to find the CN51 computer product page, click **Computers > Handheld Computers > CN51**.

4 Click the **Manuals** tab.

If your product does not have its own product page, click **Support > Manuals**. Use the **Product Category**, the **Product Family**, and **Product** to find your documentation.

Patent Information

For patent information, refer to www.hsmpats.com.

Before You Begin

1

About the Computer Features

This chapter introduces the CN51 Mobile Computer with Android™ 4.2 operating system. Use this chapter to learn about basic computer features and functions, as well as the available accessories for it.

About the CN51 Mobile Computer

The Intermec CN51 Mobile Computer is the class-leading mid-range rugged mobile computer that empowers mobile workers with the resources to satisfy and delight customers efficiently today and earn new business tomorrow.

The CN51 is available with the following features:

- Android™ 4.2 operating system
- 1.5 GHz dual-core multi-engine processor with extended battery life
- 1 GB DRAM, 16 GB flash memory
- Large, outdoor-viewable WVGA display with full-size keypad
- Resistive touch panel display
- Bluetooth radio
- UMTS/HSPA+/CDMA or UMTS/HSPA+ WAN radio options; both options support voice and data
- IEEE 802.11a/b/g/n on computers without a cellular radio, IEEE 802.11b/g/n on computers with a cellular radio
- Customer-accessible microSD slot for removable memory cards (up to 32 GB)
- High-performance EA30 or EA31 area imager options, for scanning bar codes and capturing signatures
- HTML5 support
- Integrated GPS receiver (with WAN radio option)
- Accelerometer that can automatically sense the angle of the computer and rotate the display between portrait and landscape
- 5-megapixel color camera

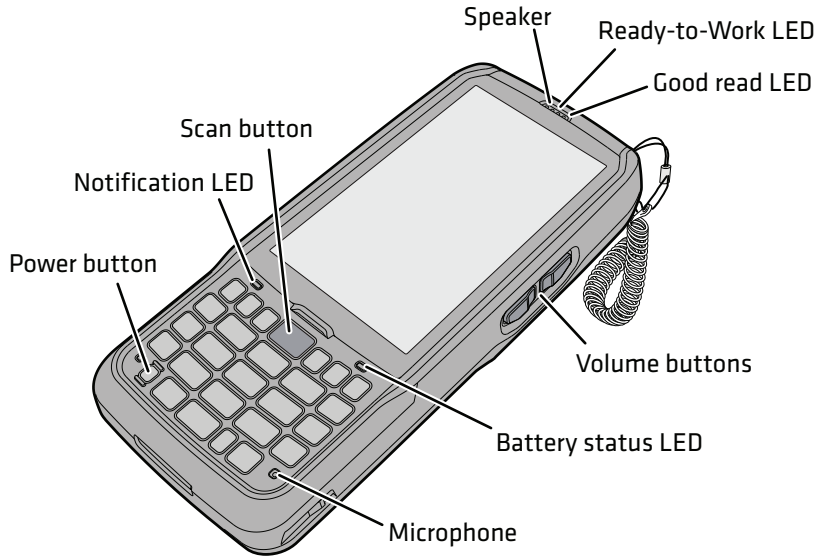

CN51 Front View

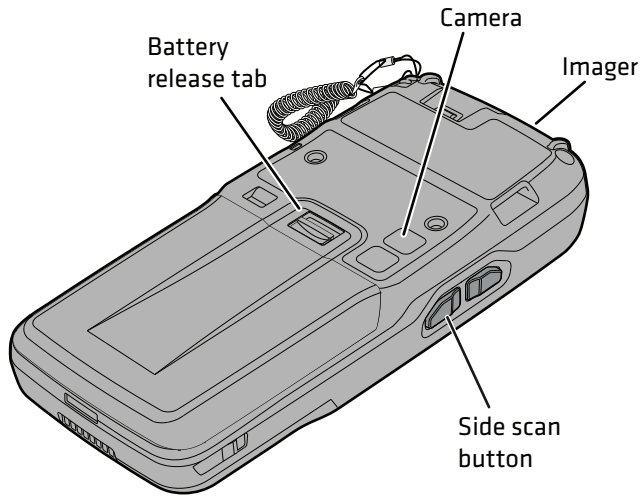

CN51 Back View

About the Battery

The CN51 uses a Model 1015AB01 battery as its main power source. The battery has a 14.4 Watt hour capacity. Several factors determine the life of your battery, such as display brightness, display timeout, input devices, extreme temperatures, and your usage.

Fully charge the battery before you use the CN51. When you change the battery, the computer automatically goes into a power-off state and then cold boots.



Caution: The battery used in this device may present a fire or chemical burn hazard if it is mistreated. Do not disassemble it, heat it above 100 °C (212 °F) or incinerate it. Dispose of used batteries promptly. Keep away from children.

Contact your Intermec representative for replacement batteries.

Charge the Battery

Make sure you fully charge the battery (Model 1015AB01) before you use your CN51. You can charge the battery before or after you install it in the CN51. A fully discharged battery charges in approximately 6 hours.

- Insert the battery into a quad battery charger, a single dock, or a multidock, or attach external power to the CN51 with the battery installed.

The battery is fully charged when the battery status LED shows a steady green.

Use these Intermec accessories to charge the CN51 batteries:

- Quad Battery Charger (Model AC21)
- Charge-Only Multidock (Model AD23)
- Ethernet Multidock (Model AD24)
- Single Dock (Model AD27)
- Vehicle Power Adapter (Model AE36)
- AC Power Adapter (Model AE37)

Change the Battery

When the battery in the CN51 has a low charge, replace it with a charged battery to maintain your network connections.



Note: When you remove a battery from the computer, Intermec recommends that you install a charged battery within 90 seconds to maintain your network connections.

- 1 Save all your files and close all open applications.
- 2 Press and hold the **Power** button. This screen appears:

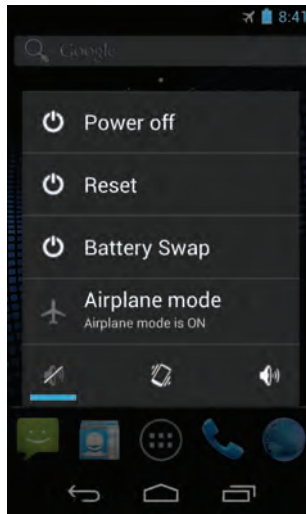

- 3 Tap **Battery Swap**. The computer briefly shows a status message and the LEDs turn on. When the LEDs turn off, continue with the next step.

If the computer is in a dock, you must remove it from the dock before you can select **Battery Swap**.

Chapter 1 – About the Computer Features

- 4 If necessary, disconnect the handstrap from the top of the computer.

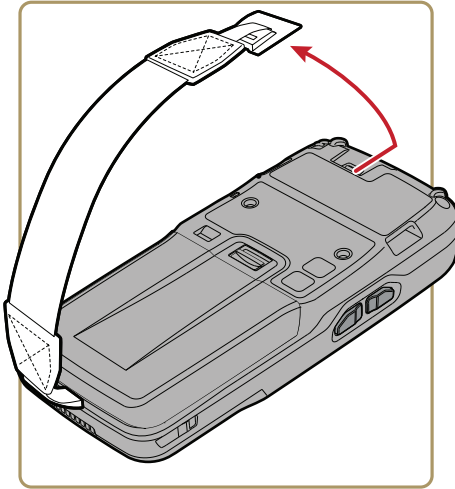

- 5 Push forward on the battery release tab until the battery releases, and then lift the battery away from the computer.

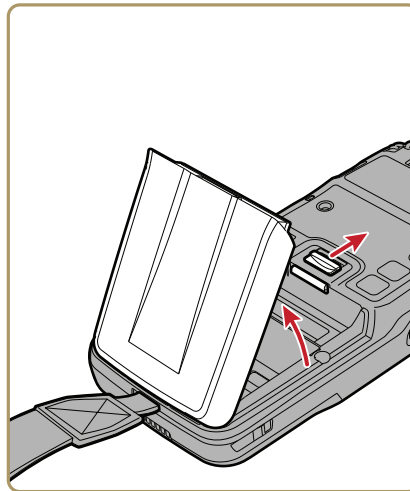





- 6 Insert the bottom end of a fully charged battery into the computer, and press down on the top end of the battery until it clicks into place.
- 7 If necessary, reattach the handstrap.

About Battery Status

Use the battery icon at the top of the screen to view the power status of the battery.

Battery Status Icons

Icon	Status
	Battery charge is at 100%.
	Battery charge is at 50%.
	Battery is critically low. You need to replace the battery now.
	Computer is connected to external power and the battery is charging.



Note:  appears if there is a battery error. Install another battery. If the problem persists, call Intermec Product Support.

The Battery status LED below the computer screen indicates the charging status of the battery.

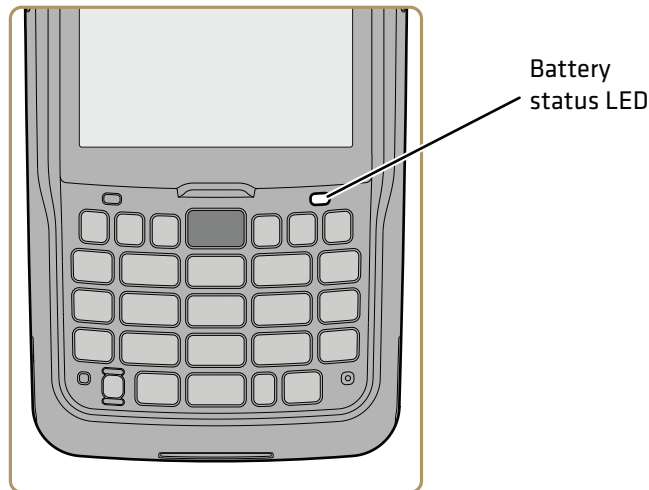

Battery LED States

LED State	Description
Steady green	The computer is connected to a charger and the battery is more than 95% charged.
Steady red	The computer is connected to a charger and the battery is less than 95% charged.
Blinking red	The battery is very low. The computer will soon go into Suspend mode. Charge or replace the battery.
Amber	There is a battery error. The battery is not charging because it is missing, faulty, or outside the allowable charging temperature range. If it is outside the charging temperature range, charging will resume when the battery temperature returns to the acceptable range of 0 °C to 45 °C (32 °F to 113 °F).
Off	The battery is not critically low, and the CN51 is not connected to an external power source.

Check the Battery Level

Besides using the charge icons, you can get the battery level status from the Settings app.

- 1 Start the Settings app.
- 2 Tap **Battery**. The current battery status and percentage level appear at the top of the screen. The list shows the battery usage for individual apps and services.

For more details, touch a graph. In the details screen for some apps, you can adjust settings that affect power usage.



Note: If you turn off certain apps, the computer may not work correctly.

Check the Battery Status

Use the BatteryInfo app to check the battery status, including health, voltage, temperature, and other useful statistics.



Note: The BatteryInfo app provides statistics for the standard 1015AB01 battery. Other compatible batteries do not support statistics.

- In the All Apps screen, tap BatteryInfo .



About Battery Life and Conservation

Batteries that are stored outside the computer for long periods of time slowly discharge. Intermec recommends storing the battery in a charger to maintain battery performance.

Battery Conservation Tips

When You Want To:

Use the computer and the low battery status icon appears or the battery light turns on.

Do This to Save Battery Power:

Connect the computer to an external power source. Press and hold the Power button, and then select **Battery Swap** from the menu. After the computer turns off, remove the battery and insert a fully charged battery.

Battery Conservation Tips (Continued)

When You Want To:	Do This to Save Battery Power:
Stop using the computer for 5 minutes or longer.	Make sure that the low battery status icon is not on the screen and the battery status LED is not on. Press the Power button to suspend the computer.
Store the computer for more than a day.	<ul style="list-style-type: none">• If you are storing the computer for a few days, like over the weekend, install a charged battery or connect the computer to a power source.• If you are storing the computer for longer, remove and charge the battery, and then store both the battery and computer in a cool location.• If you store the battery for several months, recharge the battery to keep it at peak performance.
Store the battery outside the computer.	Store the battery in a charger.

Enable Airplane Mode

If you do not need to connect to any wireless networks, you can enable Airplane mode to turn off all the radios and save battery power.

- 1 Start the Settings app.
- 2 In the Wireless & Networks section, tap **More**.
- 3 Select **Airplane mode** to enable the mode.

If Airplane mode is already enabled, tap it to disable the mode.

Quickly Enable or Disable Airplane Mode

You can quickly enable or disable Airplane Mode by holding the **Power** button and selecting **Airplane mode** from the popup menu.

- 1 Press and hold the **Power** button. This screen appears and shows the current state of Airplane mode:

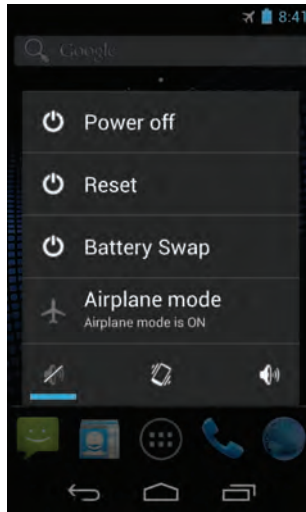

- 2 Tap **Airplane mode** to enable or disable the mode.

About the Status LEDs

The status LEDs turn on, turn off, or blink to indicate a specific activity on your computer.

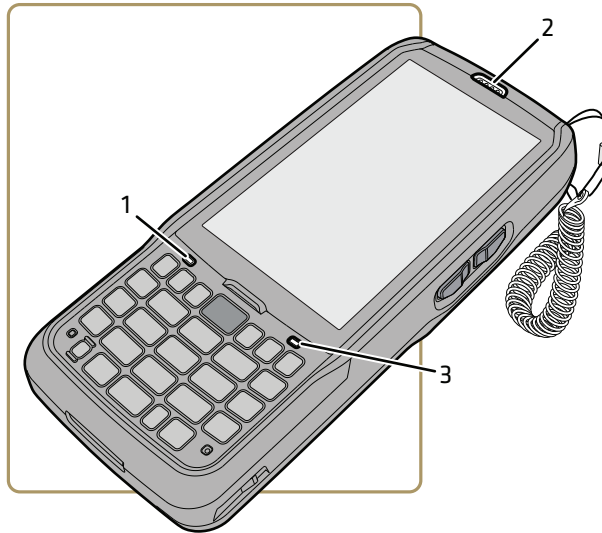

Main Status LED Descriptions

Callout	LED	Color	Description
1	Notification	Orange	Android OS notification.
2	Good Read	Green	Good read of a bar code.
		Blinking red	Bad read of a bar code.
3	Battery status	Blinking green	The data collection engine is processing or starting up.
		Steady green	The computer is connected to a charger and the battery is more than 95% charged.
		Steady red	The computer is connected to a charger and the battery is charging.
		Blinking red	The battery is very low, and the computer will go into Suspend mode soon. Charge or replace the battery.

Main Status LED Descriptions (Continued)

Callout	LED	Color	Description
		Amber	There is a battery error. The battery is not charging because it is missing, faulty, or outside the allowable charging temperature range. If it is outside the charging temperature range, charging will resume when the battery temperature returns to the acceptable range of 0 °C to 45 °C (32 °F to 113 °F).
		Off	The computer is not on external power and the battery is operating normally.



Orange and Green Key Status LED

Callout	LED	Color	Description
4	Orange and Green key status	Orange	The Orange key is enabled.
		Green	The Green key is enabled.

About the Keypad

The CN51 comes with either a numeric keypad or a QWERTY keypad:

- The numeric keypad is for applications that require mainly numeric data. This keypad also lets you enter special characters, including the alphabet, by pressing color-coded key sequences.
- The QWERTY keypad is designed for applications that require primarily alphabetic data. This keypad also lets you enter special characters by pressing color-coded key sequences.

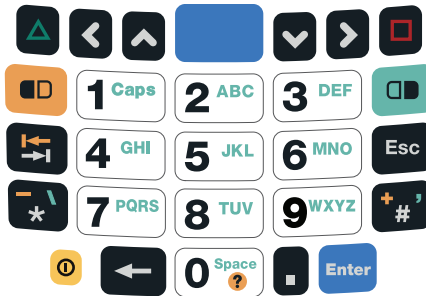

CN51 Numeric Keypad

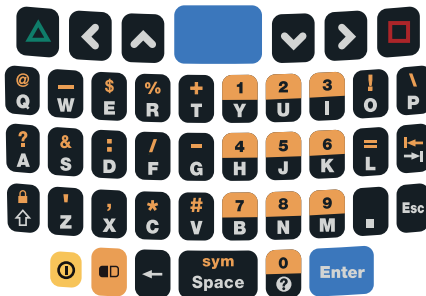



CN51 QWERTY Keypad

About the Color-Coded Keys











Note: The CN51 with QWERTY keypad does not have a green key.

Use the orange  key and the green  key to access additional characters, symbols, and functions printed on the keypad overlay. After you understand how to use the color-coded keys and key sequences, you can access all of the additional features printed on the keypad overlay.



Press the Green or Orange key twice to lock it. When the key is locked, the LED turns on. Press the key once to unlock it.

How to Use the Color-Coded Keys

You Want To	Press	Example
Use an orange character or function printed above a key.	 (LED turns on), and then the key with the character or function printed above it (LED stays on).	On the alphanumeric keypad, press  , then press M to type the number 9.
Use a green character or function printed above a key.	 (LED turns on), and then the key with the character or function printed above it (LED stays on).	On the numeric keypad, press  , then press 3 twice to type the letter “e”.
Unlock the green or orange key.	 or  once.	Press  or  once to unlock the key. The LED turns off.



How to Capitalize Characters on the QWERTY Keypad

If your CN51 has the QWERTY keypad, you can capitalize characters individually, or you can type all capital letters by enabling Caps Lock:

- To capitalize a single character, press the **Shift** key, and then the character.
- To enable Caps Lock, press  and then press the **Shift** key.
- When Caps Lock is enabled, press  and then press the **Shift** key to disable Caps Lock.

How to Capitalize Characters on the Numeric Keypad

If your CN51 has the numeric keypad, you can capitalize characters individually, or you can type all capital letters by enabling Caps Lock:

- To capitalize a single character, press the  key, and then the **1** key. Select the key with the letter you want to capitalize. Press **1** again to return to lowercase letters.
- To enable Caps Lock, press  and then press **1**.
- To disable Caps Lock, press **1** again.

About the Power Button

Press the **Power** button quickly to suspend the computer, or to resume where you left off when you last suspended the computer. When you suspend the computer this way, the phone can still receive incoming calls.

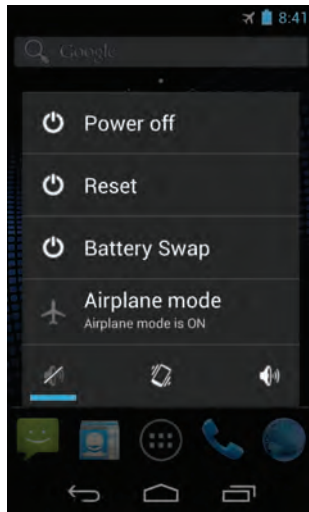

To select a power mode, press and hold the **Power** button, and select a power mode from the list that appears:



- **Power off:** Turns the computer off, including the phone. The computer will not receive incoming calls.
- **Reset:** Performs a system reset. The computer restarts after a reset, and you may lose data in open apps. All your settings are saved during a reset.

- **Battery Swap:** Turns power off to the computer but saves your settings while you install a charged battery. When you press Power after installing the charged battery, the computer resumes where you left off prior to entering battery swap mode.
- **Airplane mode:** Enables Airplane mode, which turns off power to all the radios but saves your settings.

You can also enable or disable the speaker and switch to Vibrate mode:

- Tap  to disable the speaker.
- Tap  for Vibrate mode. The speaker is disabled.
- Tap  to enable the speaker and turn off Vibrate mode.

About the Screen Backlight

The display has an ambient light sensor that automatically adjusts the backlight intensity to conserve power and ensure the display is readable. You can set the backlight intensity level as needed for your environment.

Configure the Screen Backlight Brightness

You configure the screen backlight brightness in the Settings app.

- 1** Start the Settings app and tap **Display > Brightness**.
- 2** Select the **Automatic brightness** check box to use the ambient light sensor to automatically adjust the brightness for your work environment. Or, adjust the slider to set the brightness level.
- 3** Tap **OK**.

About the Audio Features

Your mobile computer has a speaker, a microphone, and several software tools for configuring the volume of sounds.

Adjust the Ringtone and Notification Volume

You can quickly adjust the volume of ringtone and notification sounds by using the side volume buttons.



Note: This method only affects the volume of ringtone and notification sounds. To change the volume for other sounds, in the Settings app tap **Sound > Volumes**.

- 1 Press one of the right side buttons. The Volume slider appears.

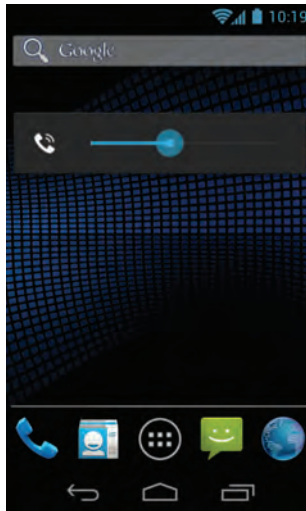



- 2 Press the right side buttons or adjust the slider to change the volume.

Enable Vibrate Mode

You can switch to Vibrate mode and disable the speaker if necessary for your working environment.

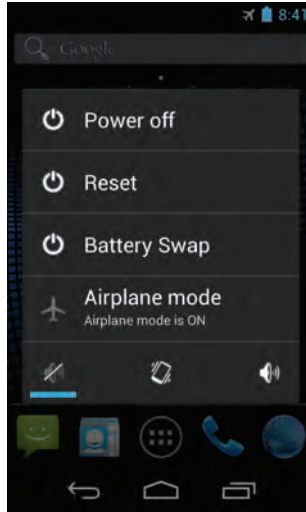
- 1 Press and hold the Power button. The power options screen appears:



- 2 Tap  to turn on Vibrate mode.

To disable Vibrate mode, tap  if you want to leave the speaker disabled, or tap  to enable audio through the speaker.

Audio Settings

This section describes the audio and sound settings you can configure in the Settings app. To change audio settings, start the Settings app and tap **Sound**.

Audio and Sound Settings

Setting	Description
Volumes	Use the sliders to set the volume for: <ul style="list-style-type: none">• music, video, games, and other media• ringtone and notifications. You can also use the side volume buttons to change the volume.• alarms
Phone ringtone	Select a ringtone.
Vibrate when ringing	Select to enable vibrate mode when the phone is ringing.
Default notification	Select a notification sound.
Dial pad touch tones	Select to enable audio tones when you use the phone keypad.
Touch sounds	Select to enable audio sounds when you use the touch screen.
Screen lock sound	Select to enable an audio tone when the screen is locked.
Vibrate on touch	Select to enable vibrate mode when you touch the screen.

Insert a microSD Card

You can use a micro Secure Digital (SD) card to increase file storage capacity or to install software. The CN51 supports an optional microSD™ card (up to 32 GB maximum capacity). The card slot is located in the battery compartment.

- 1** Remove the battery and open the card access door in the battery compartment.
- 2** Slide the SIM card holder to the left to unlatch it, and lift the holder to open it and access the microSD card holder.

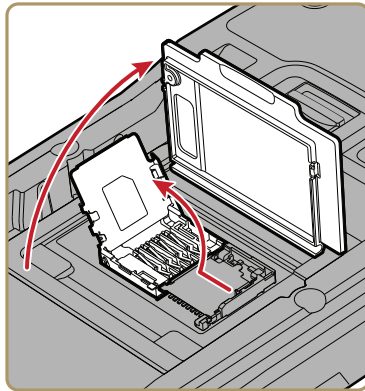

- 3** Slide the microSD card holder towards the top of the CN51 to unlatch it, and lift the holder to open it.

Chapter 1 – About the Computer Features

- 4 Place the microSD card in the holder with the contacts facing away from the holder.

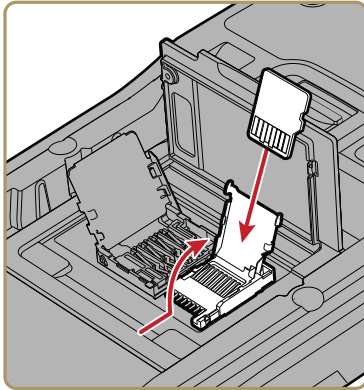

- 5 Close and latch the microSD card holder.

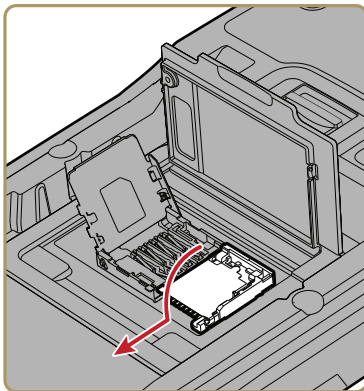

- 6 Close and latch the SIM card holder, and close the card access door until it snaps shut.
- 7 Install the battery and turn on the computer.

To verify that the card is installed correctly, start the Settings app and tap **Storage**. Look in the SD card section for more information.

If you have a file browsing app, you should now be able to navigate to the microSD card and view the contents of the card.

How to Transfer Files

To transfer files you need to physically connect the mobile computer to your desktop PC through a USB connection. When the computer is connected through USB, you can browse to it and drag-and-drop to move files back and forth to a Windows PC. If you are transferring files to and from a Mac, use the Android File Transfer application (available from www.android.com/filetransfer).

By default, the computer connects using MTP (Media Transfer Protocol). If you are transferring mainly camera images, you can configure the connection to use PTP (Picture Transfer Protocol). If your Windows PC does not support MTP, you may be able to transfer files using PTP instead.

Configure the USB Connection for PTP

By default, the CN51 connects through USB using MTP (Media Transfer Protocol), supported by Windows 7 and later. If you are transferring mainly camera images, you can configure the connection to use PTP (Picture Transfer Protocol). If your computer does not support MTP, you may be able to transfer files using PTP instead.



Note: PTP is supported by Windows XP and later. Your Windows XP computer may also support MTP if it also supports Microsoft Media Player 10.

- 1 Start the Settings app and tap **Storage**.
- 2 Tap .
- 3 Tap **USB computer connection** and then select **Camera (PTP)**.

CN51 Accessories

The CN51 ships with a battery. All other accessories are sold and ordered separately. For help, contact your local sales representative.

CN51 Accessory Descriptions

Accessory	Description
CN51 AC Power Adapter (Model AE37)	The CN51 AC Power Adapter provides a connection for external AC power to the CN51. To use this adapter, you need to purchase a country-specific power cord.
CN51 Battery (Model 1015AB01)	The battery provides power to the CN51. Keep a spare battery pack on hand for longer shifts.
CN51 Charge-Only Multidock (Model AD23)	Use the charge-only multidock to hold up to four CN51s with batteries installed, charge batteries, and provide power to the computers.
FlexDock: DX4 Quad Dock	Use the DX4 Quad Dock to charge up to 4 computers and batteries simultaneously. The Quad Dock is available in Ethernet and charge-only versions.
CN51 Ethernet Multidock (Model AD24)	Use the multidock to hold up to four CN51s with the batteries installed. The multidock charges the batteries and provides power and Ethernet connections to each computer.
CN51 Replacement Handstrap	Use a replacement handstrap to replace a worn-out or lost handstrap.
CN51 Magnetic Stripe Reader (Model AR9)	This accessory snaps on to the CN51 and provides magnetic stripe reading capabilities.
CN51 Quad Charger (Model AC21)	Use the quad battery charger to charge up to four batteries.
CN51 RS-232 Adapter	This accessory snaps on to the CN51 and provides serial connectivity.

CN51 Accessory Descriptions (Continued)

Accessory	Description
CN51 Single Dock (Model AD27)	Use the single dock to hold a CN51 with its battery installed, charge a spare battery pack, charge the main battery pack, and provide power to the mobile computer. The dock has USB host and client connectors. Optional adapters are available to convert the USB host to Ethernet or to a landline modem.
Ethernet Adapter (Model 1004UA01)	Use this Ethernet adapter with the Model AD27 Single Dock to connect the CN51 to your Ethernet network.
Modem Adapter (Model 1004UA02)	Use this modem adapter with the Model AD27 Single Dock to connect the CN51 to a landline modem.
CN51 Tethered Stylus Replacement	Use a replacement stylus to replace a lost or broken stylus.
CN51 Vehicle Docks (AV6, AV9)	Use the vehicle docks to hold and charge the CN51 while using it on a vehicle.
CN51 Vehicle Power Adapter (Model AE36)	Use the vehicle power adapter to charge the battery installed in the CN51 from your vehicle.

2

About the User Interface and Intermec Applications

Use this chapter to learn about the Android user interface and how to interact with the screen. You can also use this chapter to learn about the Intermec applications on your computer, as well as additional applications you can download.

About the User Interface

The Android 4.2 operating system provides a touch-friendly and easy to navigate user interface.

About the Home Screen



When you turn on the mobile computer, the Home screen is the first screen that appears after language provisioning is complete.



Home Screen Icons and Navigation

Item	Description
1	Status and system icons. Status icons to the left tell you when an app has sent notifications, such as an arriving message or a meeting notice. System icons to the right display the current wireless and network connection state and battery level.
2	Favorites tray. App icons in the tray are visible on every Home screen. The All Apps icon is always in the center of the Favorites tray.

Home Screen Icons and Navigation (Continued)

Item	Description
3	Navigation buttons:  - Back button. Tap to return to the previous screen, even if that screen was in a different app.  - Home button. Tap to return to the Home screen. If there are multiple Home screens, tap to return to the center Home screen.  - Recent Apps button. Tap to return to the previous screen, even if it was in a different app.

View Notifications

- Swipe down from the top of the screen. The notifications shade includes a list of events.

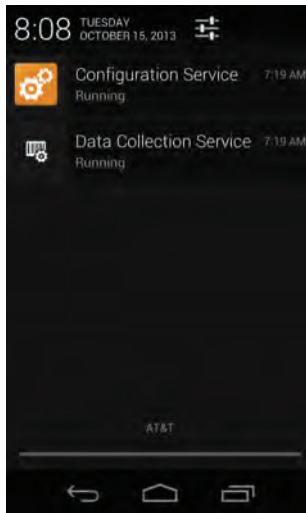

To close the shade, swipe up from the bottom of the screen, or tap the Back or Home buttons.

Customize the Home Screen

You can add application icons to any Home screen to access them more easily.

- 1** Touch . The All Apps screen appears.
- 2** To add an app icon to a Home screen, touch and hold the icon for the app, and then slide your finger to place the icon on one of the Home screens.

To add a widget icon to a Home screen, touch **WIDGETS** at the top of the screen, touch and hold the icon for the widget, and then slide your finger to place the widget icon on one of the Home screens.

- 3** To remove an app or widget from the Home screen, touch and hold the icon and slide it over **Remove** at the top of the screen.

Customize the Favorites Tray

You can add application icons to the Favorites tray to access them more easily.

- 1** Touch . The All Apps screen appears.
- 2** Touch and hold an icon in the Favorites tray, and slide it over **Remove** at the top of the screen.
- 3** To add an app icon to the Favorites tray, touch and hold the icon for the app, and then slide your finger to place the icon in the Favorites tray.

To add a Widget icon to the Favorites tray, touch **WIDGETS** at the top of the All Apps screen, touch and hold the icon for the widget, and then slide your finger to place the icon in the Favorites tray.

Use Google™ Search

Use the Google Search field at the top of the Home screen to help you find anything you need on the computer or on the web.

- 1** At the top of any Home screen, touch **Google** to type your search term. As you type, suggestions from Google web search appear below the Search box, and results from the computer (such as apps or contacts) appear below the web search results.
- 2** Tap a suggestion to search for it immediately, or touch its arrow just to add the term to the search field without starting to search.

About Screen Gestures

Use your fingers or the stylus to manipulate icons, buttons, menus, the onscreen keyboard, and other items on the screen.

- To select or activate something, tap it.
- To type something, such as a name or password, touch where you want to type. A keyboard appears that lets you type into the field.

Other common gestures include:

- **Touch and hold:** Touch and hold an item by touching it and lifting your finger until an action occurs.
- **Drag:** Touch and hold an item for a moment. Without lifting your finger, move your finger on the screen until you reach the target position. For example, you can drag to reposition shortcuts on the Home screen.
- **Swipe or slide:** Quickly move your finger across the screen, without pausing when you first touch. For example, you can slide a Home screen left or right to view the other Home screens.
- **Double-tap:** Tap quickly twice on a webpage, map, or other screen to zoom in. Double-tap again to zoom out.
- **Pinch:** In some apps, you can zoom in and out by placing two fingers on the screen at once and pinching them together (to zoom out) or spreading them apart (to zoom in).

Set the Time Zone

The CN51 gets the current date and time from its network connection. You can manually set the time zone for your location.

- 1 Start the Settings app.
- 2 Tap **Date & time**.
- 3 Clear the check box for **Automatic time zone**.
- 4 Tap **Select time zone** and select the time zone for your location.

Manage Notifications

When an app sends a notification to the computer, you can act on it in several ways.

- 1 When notification icons appear, swipe your finger down from the top of the screen to see the notifications.
- 2 To respond to a notification, touch it. The appropriate app opens for your response.

To dismiss a notification, swipe it sideways.

To dismiss all notifications, tap the X in the top right corner.





Note: Most apps that send notifications have notification settings you can change. When the list of notifications is open, tap  to open the Settings app.

About Intermec Applications

Intermec provides several useful applications to help you configure, troubleshoot, and connect your computer to other devices and networks. You can also download additional applications from the Intermec website to help you use all of the features of your computer.

Intermec Apps on the Computer

Intermec apps help you configure, troubleshoot, and connect your computer to other devices and networks.

Icon	App	Description
	BatteryInfo	Use the BatteryInfo app to view battery status, including charge level, health, voltage, current draw, temperature, and other data. Supported when you use the standard 1015AB01 battery in the CN51.
	Carrier Selection	(Flexible Network Radio only) Use the Carrier Selection app to quickly change your network carrier.
	Scan Demo	Use the Scan Demo app to read bar codes and verify your symbology decode settings.

3

Use the Scanner

This section describes how to use and configure the scanner to scan bar codes.

About the Scanner

The internal scanner can read 1D and 2D bar code symbologies, composite symbologies, and postal codes.

Disable the Scanner

The scanner is enabled by default. You can disable the scanner from the Settings app. When the scanner is disabled:

- you cannot make changes to scanner or symbology decode settings, and your current settings are saved.
- pressing the Scan button (or triggering the scanner through software) has no effect.

When you enable the scanner, your settings and all triggering methods are restored.



Note: Disabling the scanner also disables symbology decoding.

- 1 Start the Settings app.
- 2 Tap **Scanners**.

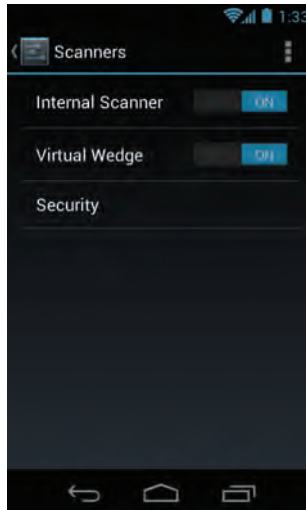

- 3 Slide the **Internal Scanner** switch off to disable the scanner.

To enable the scanner, slide the switch on.

Disable the Virtual Wedge

When the scanner reads bar code data, the virtual wedge sends the data to an application as keyboard input. By default, the virtual wedge is enabled. You can disable the virtual wedge from the Settings app.

- 1 Start the Settings app.
- 2 Tap **Scanners**.

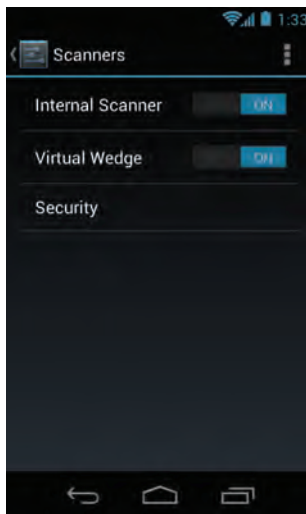

- 3 Slide the **Virtual Wedge** switch off.

To enable the virtual wedge, slide the switch on.

Enable Symbology Decoding

Before you start reading bar codes, use the Settings app to enable decoding for only the bar code symbologies you need to read.

- 1 Start the Settings app.
- 2 In the Intermec section, tap **Scanners > Internal Scanners > Symbologies**.

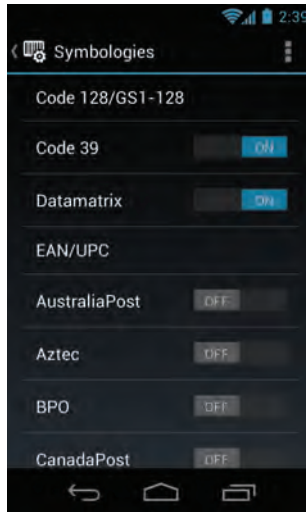

By default, decoding is enabled for these symbologies:

- Code 128 and GS1-128
 - Code 39
 - Datamatrix
 - UPC-A, UPC-E, EAN-8, and UPC-E1
 - PDF417
- 3 To enable decoding for a symbology type, slide the switch on.
To disable decoding, slide the switch off.

Scan Bar Codes

All of the scanners have an aiming beam to help you correctly frame bar codes and they support omni-directional (360°) scanning.



Note: Before you start scanning bar codes, use the Settings app to enable only the bar code symbologies that you need.

- 1 Point the scanner window at the bar code and hold the computer steady a few inches from the label.
- 2 Press the **Scan** button or pull the scan handle trigger. The illumination beam, laser pointer, or frame appear.

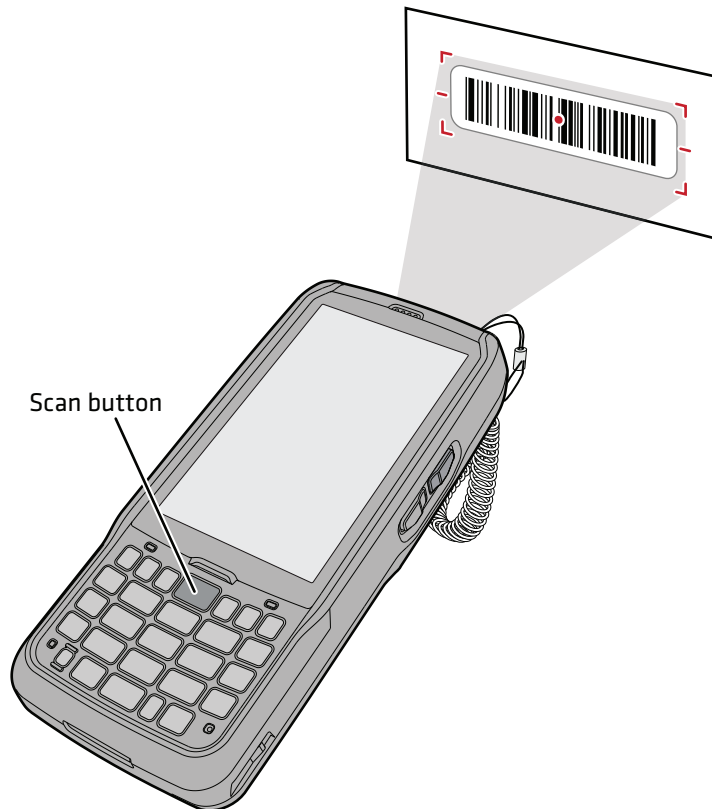

For near or close-in scanning distances of 30 cm (11.8 in) or less, use the laser pointer as a guide and aim slightly to the right of the center of the bar code. Make sure the illumination beam covers the bar code you are trying to decode.

For standard and long range scanning distances of 30 cm (11.8 in) or more, use the laser pointer as a guide and aim toward the middle of the bar code. Make sure that the illumination beam covers the bar code you are trying to decode.

When the scanner successfully reads a bar code label, you hear a high beep, and the Good Read LED turns on briefly.

- 3 Release the **Scan** button or trigger.

Enable Access to URLs in Bar Codes

By default, scanning a bar code that contains URL information automatically opens the corresponding webpage in the Browser app. You can disable this feature in the Settings app.

- 1 Start the Settings app.
- 2 Tap **Scanners > Security**.

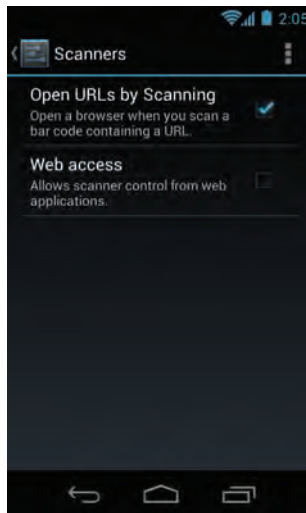

- 3 Clear the check box for **Open URLs by Scanning**.

Enable Scanner Control from Web Applications

By default, web applications cannot control the scanner. You can enable scanner control from web applications in the Settings app.

- 1 Start the Settings app.
- 2 Tap **Scanners > Security**.
- 3 Select **Web access**.

Use the Scan Demo App

Use the Scan Demo app to read bar codes, or to test your symbology decode settings.

- 1 In the All Apps screen, tap **Scan Demo** .
- 2 Aim the scanner window at the bar code and press **Scan**, or pull the scan handle trigger.

When the scanner successfully scans the bar code, you hear a high beep, and the Good Read LED turns on briefly. A list of bar code information appears.

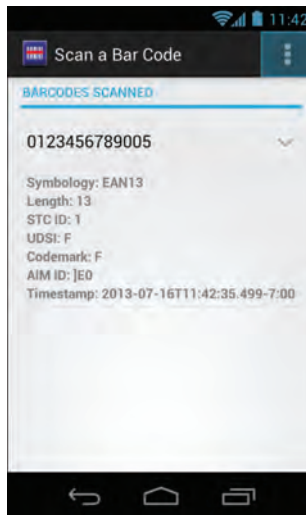

- 3 To clear all scanned bar code information, tap  and select **Clear All**.

- 4 To enable or disable decoding for specific symbologies:
 - a Tap  and select **Settings**.
 - b Tap **1D**, **2D**, or **Postal** to locate the specific symbology.
 - c Tap the symbology name to enable decoding for that symbology, or to clear the check box and disable decoding.

How to Configure the Scanner

You use the Settings app to view and configure all settings for the scanner, including symbology decoding options, triggering modes, and decode security.

Configure Symbology Decoding Options

You use the Settings app to configure symbology decoding options for the scanner.

- 1 Start the Settings app and tap **Scanners > Internal Scanner > Symbologies**.

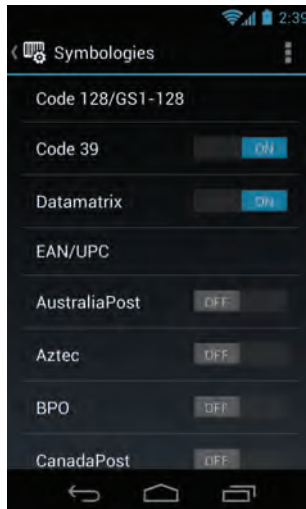

- 2 (Optional) To restore all default settings for symbology decoding, tap  and select **Restore defaults**.

- 3 To enable decoding of a specific symbology, slide the switch on, or to disable decoding, slide the switch off.

If there is no switch:

- a Tap the symbology name. The menu for that symbology appears. This example shows the menu for EAN/UPC:



- b Find the symbology name in the list, and slide the switch on or off to enable or disable decoding as necessary.
- c Tap the **Back** button to return to the **Symbologies** list.
- 4 For more decoding options, in the **Symbologies** list tap the symbology name. The menu for that symbology appears.
- 5 Tap an option to change the settings. Changes are automatically saved.

Australia Post Settings

This section lists all configurable settings for decoding the Australia Post symbology.

Australia Post Settings and Descriptions

Setting	Description
User defined symbology ID	Sets the symbology ID for Australia Post. Range is 1 to 4 ASCII characters. \xFF is not supported. Default is P3.
Code mark	A one-character code mark that serves as an identifier for Australia Post. Default is *.

Aztec Settings

This section lists all configurable settings for decoding the Aztec symbology.

Aztec Settings and Descriptions

Setting	Description
Structured append mode	Enables or disables Aztec structure append mode. Default is disabled.
Runes	Enables or disables Aztec Runes, which are special Aztec symbols. Default is disabled.
GS1-128 emulation	Enables or disables GS1-128 emulation. Default is disabled.
User defined symbology ID	Sets the symbology ID for Aztec. Range is 1 to 4 ASCII characters. \xFF is not supported. Default is D3.
Code mark	A one-character code mark that serves as an identifier for Aztec. Default is *.

BPO Settings

This section lists all configurable settings for decoding the BPO symbology.

BPO Settings and Descriptions

Setting	Description
Transmit check digit	Enables or disables sending the check digit as part of the bar code data. Default is enabled.
User defined symbology ID	Sets the symbology ID for BPO. Range is 1 to 4 ASCII characters. \xFF is not supported. Default is P2.
Code mark	A one-character code mark that serves as an identifier for BPO. Default is *.

Canada Post Settings

This section lists all configurable settings for decoding the Canada Post symbology.

Canada Post Settings and Descriptions

Setting	Description
User defined symbology ID	Sets the symbology ID for BPO. Range is 1 to 4 ASCII characters. \xFF is not supported. Default is P6.
Code mark	A one-character code mark that serves as an identifier for BPO. Default is *.

Codabar Settings

This section lists all configurable settings for decoding the Codabar symbology.

Codabar Settings and Descriptions

Setting	Description
Start/Stop transmit	<p>Enables or disables a special bar code character that provides the scanner with start and stop reading instructions as well as a scanning direction indicator. Options include:</p> <ul style="list-style-type: none"> • Disable (default) • a,b,c,d • A,B,C,D • a,b,c,d/t,n,*,e • DC1,DC2,DC3,DC4
CLSI library system	<p>Enables or disables the CLSI library system. Default is disabled.</p>
Verify check digit	<p>Enables or disables the optional check digit for a higher level of security. Default is disabled.</p>
Transmit check digit	<p>Enables or disables transmission of the check digit as part of the bar code data. Default is disabled.</p>
Concatentation	<p>Enables or disables concatenation of Codabar bar codes. Options include:</p> <ul style="list-style-type: none"> • Disable (default) • Transmit concatenation only: Scanner sends only concatenated bar code data. • Transmit concatenation or single: Scanner sends all bar code data.
Concatentation mode	<p>Sets the concatenation mode. Options include:</p> <ul style="list-style-type: none"> • No restriction (default) • 2nd code = 1st code start • ABC
User defined symbology ID	<p>Sets the symbology ID for Codabar. Range is 1 to 4 ASCII characters. \xFF is not supported. Default is B7.</p>
Code mark	<p>A one-character code mark that serves as an identifier for BPO. Default is D.</p>

Codabar Length Mode Settings and Descriptions

Setting	Description
Mode	Sets the length mode for Codabar decoding. Options include: <ul style="list-style-type: none"> • Length 1 minimum (default) • Lengths 1,2,3 fixed • Length 1 minimum, length 2 maximum
Length 1	Restricts the length of the bar code that the scanner will read. Range is 0 to 255. Default is 6.
Length 2	Restricts the length of the bar code that the scanner will read. Range is 0 to 255. Default is 0.
Length 3	Restricts the length of the bar code that the scanner will read. Range is 0 to 255. Default is 0.

Codablock A Settings

This section lists all configurable settings for decoding the Codablock A symbology.

Codablock A Settings and Descriptions

Setting	Description
User defined symbology ID	Sets the symbology ID for Codablock A. Range is 1 to 4 ASCII characters. \xFF is not supported. Default is K0.
Code mark	A one-character code mark that serves as an identifier for Codablock A. Default is *.

Codablock F Settings

This section lists all configurable settings for decoding the Codablock F symbology.

Codablock F Settings and Descriptions

Setting	Description
User defined symbology ID	Sets the symbology ID for Codablock F. Range is 1 to 4 ASCII characters. \xFF is not supported. Default is K1.
Code mark	A one-character code mark that serves as an identifier for Codablock F. Default is *.

Code 11 Settings

This section lists all configurable settings for decoding the Code 11 symbology.

Code 11 Settings and Descriptions

Setting	Description
Verify check digit	Sets the check digit to 1 or 2 digits. Default is 2.
Transmit check digit	Enables or disables transmission of the check digit as part of the bar code data. Default is enabled.
User defined symbology ID	Sets the symbology ID for Code 11. Range is 1 to 4 ASCII characters. \xFF is not supported. Default is C1.
Code mark	A one-character code mark that serves as an identifier for Code 11. Default is *.

Code 11 Length Mode Settings and Descriptions

Setting	Description
Length Mode	Sets the length mode for decoding. Options include: <ul style="list-style-type: none"> • Length 1 minimum (default) • Lengths 1,2,3 fixed • Length 1 minimum, length 2 maximum
Length 1	Restricts the length of the bar code that the scanner will read. Range is 0 to 255. Default is 4.
Length 2	Restricts the length of the bar code that the scanner will read. Range is 0 to 255. Default is 0.
Length 3	Restricts the length of the bar code that the scanner will read. Range is 0 to 255. Default is 0.

Code 39 Settings

This topic lists all settings for decoding the Code 39 symbology.

Code 39 Settings and Descriptions

Setting	Description
Full ASCII conversion	Enables or disables full ASCII conversion. Default is disabled.
Start/stop transmission	Enables or disables a special bar code character that provides the scanner with start and stop reading instructions as well as a scanning direction indicator. Default is disabled.
Start character	Sets the start character to \$ only, *only, or both \$ and *. Default is *.
Verify check digit	Sets the check digit for a higher level of security. The check character is positioned between the final data character and the stop character. Options include: <ul style="list-style-type: none"> • Disable (default) • Modulo 43 • French CIP • Italian CPI • HIBC • AIAG

Code 39 Settings and Descriptions (Continued)

Setting	Description
Reading range	Sets the reading range. Options include: <ul style="list-style-type: none"> • Normal • Extended (default)
Reading tolerance	Sets the quality of the bar code that the scanner reads. Options include: <ul style="list-style-type: none"> • High (default): Makes it easier to scan low quality bar codes. • Medium • Low: Bar codes must be high quality to be read.
Transmit check digit	Enables or disables sending the check digit as part of the bar code data. Default is disabled.
Unconventional Code 39	Enables or disables decoding of Unconventional Code 39, including bar codes with a large intercharacter gap or a large narrow and wide element ratio. Default is disabled.
Code 39 User defined symbology ID	Sets the symbology ID for Code 39. Range is 1 to 4 ASCII characters. \xFF is not supported. Default is B1.
Code 39 Code mark	A one-character code mark that serves as an identifier for Code 39. Default is *.

Code 39 Length Mode Settings and Descriptions

Setting	Description
Length Mode	Sets the length mode for decoding. Options include: <ul style="list-style-type: none"> • Length 1 minimum (default) • Lengths 1,2,3 fixed • Length 1 minimum, length 2 maximum
Length 1	Restricts the length of the bar code that the scanner will read. Range is 0 to 255. Default is 0.
Length 2	Restricts the length of the bar code that the scanner will read. Range is 0 to 255. Default is 0.
Length 3	Restricts the length of the bar code that the scanner will read. Range is 0 to 255. Default is 0.

Code 93 Settings

This section lists all configurable settings for decoding the Code 93 symbology.

Code 93 Settings and Descriptions

Setting	Description
User defined symbology ID	Sets the symbology ID for Code 93. Range is 1 to 4 ASCII characters. \xFF is not supported. Default is B6.
Code mark	A one-character code mark that serves as an identifier for Code 93. Default is D.

Code 93 Length Mode Settings and Descriptions

Setting	Description
Length Mode	Sets the length mode for decoding. Options include: <ul style="list-style-type: none"> • Length 1 minimum (default) • Lengths 1,2,3 fixed • Length 1 minimum, length 2 maximum
Length 1	Restricts the length of the bar code that the scanner will read. Range is 0 to 255. Default is 1.
Length 2	Restricts the length of the bar code that the scanner will read. Range is 0 to 255. Default is 0.
Length 3	Restricts the length of the bar code that the scanner will read. Range is 0 to 255. Default is 0.

Code 128/GS1-128 Settings

This section lists all settings for decoding the Code 128/GS1-128 symbology.

Code 128/GS1-128 Settings and Descriptions

Setting	Description
Code 128	Enables or disables decoding of Code 128. Default is enabled.
GS1-128	Enables or disables decoding of GS1-128. Default is enabled.
ISBT 128	Enables or disables decoding of ISBT 128. Default is disabled.
GS1-128 identifier	Enables or disables the GS1-128 Application Identifier (AI). The AI is a prefix code identifying the meaning and format of the data that follows it. Default is enabled.
Unconventional GS1-128	Enables or disables decoding of Unconventional GS1-128, a GS1-128 variant with two FNC1 characters at the beginning. Default is enabled.
ISBT concatenation transmission	Enables or disables concatenated bar codes, allowing two bar codes to be read as if they were a single bar code. Options include: <ul style="list-style-type: none"> • Disable (default) • Concatenated code • Concatenated or single codes
Verify check digit	Sets the check digit for a higher level of security. The check character is positioned between the final data character and the stop character. Options include: <ul style="list-style-type: none"> • Disable (default) • French CIP
Reading tolerance	Sets the quality of the bar code that the scanner reads. Options include: <ul style="list-style-type: none"> • High (default): Makes it easier to scan low quality bar codes. • Medium • Low: Bar codes must be high quality to be read.
GTIN compliant	Enables or disables GTIN compliance. Default is disabled.

Code 128/GS1-128 Settings and Descriptions (Continued)

Setting	Description
Length Mode	Sets the length mode for decoding. Options include: <ul style="list-style-type: none"> • Length 1 minimum (default) • Lengths 1,2,3 fixed • Length 1 minimum, length 2 maximum
Length 1	Restricts the length of the bar code that the scanner will read. Range is 0 to 255. Default is 0.
Length 2	Restricts the length of the bar code that the scanner will read. Range is 0 to 255. Default is 0.
Length 3	Restricts the length of the bar code that the scanner will read. Range is 0 to 255. Default is 0.
Code 128 User defined symbology ID	Sets the symbology ID for Code 128. Range is 1 to 4 ASCII characters. \xFF is not supported. Default is B3.
Code 128 Code mark	A one-character code mark that serves as an identifier for Code 128. Default is D.
GS1-128 User defined symbology ID	Sets the symbology ID for GS1-128. Range is 1 to 4 ASCII characters. \xFF is not supported. Default is C9.
GS1-128 Code mark	A one-character code mark that serves as an identifier for GS1-128. Default is D.

Datamatrix Settings

This section lists the configurable settings for decoding the Datamatrix symbology.

Datamatrix Settings and Descriptions

Setting	Description
Mirrored labels	Enables or disables reading mirrored labels. Default is disabled.
User defined symbology ID	Sets the symbology ID for Datamatrix. Range is 1 to 4 ASCII characters. \xFF is not supported. Default is D0.
Code mark	A one-character code mark that serves as an identifier for Datamatrix. Default is *.

Dutch Post Settings

This section lists all configurable settings for decoding the Dutch Post symbology.

Dutch Post Settings and Descriptions

Setting	Description
User defined symbology ID	Sets the symbology ID for Dutch Post. Range is 1 to 4 ASCII characters. \xFF is not supported. Default is P4.
Code mark	A one-character code mark that serves as an identifier for Dutch Post. Default is *.

EAN/UPC Settings

This section lists the configurable settings for decoding the EAN/UPC symbology.

EAN/UPC Settings and Descriptions

Setting	Description
UPC-A	Enables or disables UPC-A decoding. Default is enabled.
UPC-E	Enables or disables UPC-E decoding. Default is enabled.
EAN-8	Enables or disables EAN-8 decoding. Default is enabled.
EAN-13	Enables or disables EAN-13 decoding. Default is enabled.
UPC-E1	Enables or disables UPC-E1 decoding. Default is disabled.
Add-on digits	Sets whether or not add-on digits must be present in the bar code. Options include: <ul style="list-style-type: none">• Transmit if found (default): The scanner reads all bar codes.• Controlled by add-on digits: The scanner reads the bar code only if add-on digits are present.

EAN/UPC Settings and Descriptions (Continued)

Setting	Description
Add-on 2 digits active	Enables or disables transmission of the two-digit add-on (when present). Default is disabled.
Add-on 5 digits active	Enables or disables transmission of the five-digit add-on (when present). Default is disabled.
Add-on security	Value that increases the odds that the scanner will read add-on digits encoded in the bar code. Range is 0 to 100. Default is 10. Setting this parameter to 100 (the highest value) does not guarantee that the imager will read the add-on digits.
Reading range	Sets the reading range. Options include: <ul style="list-style-type: none"> • Normal • Extended (default)
Transmit UPC-A as EAN-13	Enables or disables transmission of UPC-A as EAN-13. Default is disabled.
Transmit UPC-E as UPC-A	Enables or disables transmission of UPC-E as UPC-A. Default is disabled.
Transmit EAN-8 as EAN-13	Enables or disables transmission of EAN-8 as EAN-13. Default is disabled.
GTIN compliant	Enables or disables GTIN compliance. Default is disabled.
UPC-A	

UPC-A Options

Setting	Description
Number system transmission	Enables or disables transmission of the UPC-A number system character. Default is enabled.
Check digit	Enables or disables reading the check digit. Default is enabled.
User defined symbology ID	Sets the symbology ID for UPC-A. Range is 1 to 4 ASCII characters. \xFF is not supported. Default is A0.
Code mark	A one-character code mark that serves as an identifier for UPC-A. Default is A.

UPC-E Options

Setting	Description
Number system transmission	Enables or disables transmission of the UPC-E number system character. Default is enabled.
Check digit	Enables or disables reading the check digit. Default is enabled.
User defined symbology ID	Sets the symbology ID for UPC-E. Range is 1 to 4 ASCII characters. \xFF is not supported. Default is E0.
Code mark	A one-character code mark that serves as an identifier for UPC-E. Default is E.

EAN-8 Options

Setting	Description
Check digit	Enables or disables reading the check digit. Default is enabled.
User defined symbology ID	Sets the symbology ID for EAN-8. Range is 1 to 4 ASCII characters. \xFF is not supported. Default is FF.
Code mark	A one-character code mark that serves as an identifier for EAN-8. Default is N.

EAN-13 Options

Setting	Description
Check digit	Enables or disables reading the check digit. Default is enabled.
ISBN conversion	Enables or disables conversion of EAN-13 data to ISBN format. Default is disabled.
ISMN conversion	Enables or disables conversion of EAN-13 data to ISMN format. Default is disabled.
ISSN conversion	Enables or disables conversion of EAN-13 data to ISSN format. Default is disabled.

EAN-13 Options (Continued)

Setting	Description
User defined symbology ID	Sets the symbology ID for EAN-13. Range is 1 to 4 ASCII characters. \xFF is not supported. Default is F.
Code mark	A one-character code mark that serves as an identifier for EAN-13. Default is F.

GS1 Composite Settings

This section lists all configurable settings for decoding the GS1 Composite symbology.

GS1 Composite Settings and Descriptions

Setting	Description
GS1-128 emulation	Enables or disables transmission of data encoded in the Composite symbol as if the data were encoded in one or more GS1 Composite/GS1-128 symbols. Default is disabled.
Linear only transmit mode	Enables or disables transmission of only the linear portion of the GS1 composite bar code. Default is disabled.
EAN/UPC comp message decode	Determines how to decode the two parts of the GS1 Composite bar code. Options include: <ul style="list-style-type: none"> • Never linked • Always linked • Auto-discriminate
Unconventional GS1 Composite	Enables or disables decoding of Unconventional GS1 Composite. Default is disabled.

GS1 Composite A/B Settings and Descriptions

Setting	Description
User defined symbology ID	Sets the symbology ID. Range is 1 to 4 ASCII characters. \xFF is not supported. Default is G0.
Code mark	A one-character code mark that serves as an identifier. Default is *.

GS1 Composite C Settings and Descriptions

Setting	Description
User defined symbology ID	Sets the symbology ID. Range is 1 to 4 ASCII characters. \xFF is not supported. Default is G1.
Code mark	A one-character code mark that serves as an identifier. Default is *.

GS1 DataBar Expanded Settings

This section lists all configurable settings for decoding the GS1 DataBar Expanded symbology.

GS1 DataBar Expanded Settings and Descriptions

Setting	Description
User defined symbology ID	Sets the symbology ID for GS1 DataBar Expanded. Range is 1 to 4 ASCII characters. \xFF is not supported. Default is C5.
Code mark	A one-character code mark that serves as an identifier for GS1 DataBar Expanded. Default is *.

GS1 DataBar Limited Settings

This section lists all configurable settings for decoding the GS1 DataBar Limited symbology.

GS1 DataBar Limited Settings and Descriptions

Setting	Description
User defined symbology ID	Sets the symbology ID for GS1 DataBar Limited. Range is 1 to 4 ASCII characters. \xFF is not supported. Default is C4.
Code mark	A one-character code mark that serves as an identifier for GS1 DataBar Limited. Default is *.

GS1 DataBar Omni-Directional Settings

This section lists all configurable settings for decoding the GS1 DataBar Omni-Directional symbology.

GS1 DataBar Omni-Directional Settings and Descriptions

Setting	Description
User defined symbology ID	Sets the symbology ID for GS1 DataBar Omni-Directional. Range is 1 to 4 ASCII characters. \xFF is not supported. Default is C3.
Code mark	A one-character code mark that serves as an identifier for GS1 DataBar Omni-Directional. Default is *.

Han Xin Settings

This topic lists all configurable settings for decoding the Han Xin symbology.

Han Xin Settings and Descriptions

Setting	Description
User defined symbology ID	Sets the symbology ID for Han Xin. Range is 1 to 4 ASCII characters. \xFF is not supported. Default is D4.
Code mark	A one-character code mark that serves as an identifier for Han Xin. Default is *.

Infomail Settings

This section lists all configurable settings for decoding the Infomail symbology.

Infomail Settings and Descriptions

Setting	Description
User defined symbology ID	Sets the symbology ID for Infomail. Range is 1 to 4 ASCII characters. \xFF is not supported. Default is P8.
Code mark	A one-character code mark that serves as an identifier for Infomail. Default is *.

Intelligent Mail Settings

This section lists all configurable settings for decoding the Intelligent Mail symbology.

Intelligent Mail Settings and Descriptions

Setting	Description
User defined symbology ID	Sets the symbology ID for Intelligent Mail. Range is 1 to 4 ASCII characters. \xFF is not supported. Default is PA.
Code mark	A one-character code mark that serves as an identifier for Intelligent Mail. Default is *.

Interleaved 2 of 5 Settings

This section lists all configurable settings for decoding the Interleaved 2 of 5 symbology.

Interleaved 2 of 5 Settings and Descriptions

Setting	Description
Verify check digit	Enables or disables the optional check digit for a higher level of security. Default is disabled.
Transmit check digit	Enables or disables transmission of the check digit as part of the bar code data. Default is disabled.
Reading range	Sets the reading range. Options include: <ul style="list-style-type: none"> • Normal • Extended (default)
Reading tolerance	Sets the quality of the bar code that the scanner reads. Options include: <ul style="list-style-type: none"> • High (default): Makes it easier to scan low quality bar codes. • Medium • Low: Bar codes must be high quality to be read.
User defined symbology ID	Sets the symbology ID for Interleaved 2 of 5. Range is 1 to 4 ASCII characters. \xFF is not supported. Default is B2.

Interleaved 2 of 5 Settings and Descriptions (Continued)

Setting	Description
Code mark	A one-character code mark that serves as an identifier for Interleaved 2 of 5. Default is I.

Interleaved 2 of 5 Length Mode Settings and Descriptions

Setting	Description
Mode	Sets the length mode for Interleaved 2 of 5 decoding. Options include: <ul style="list-style-type: none"> • Length 1 minimum (default) • Lengths 1,2,3 fixed • Length 1 minimum, length 2 maximum
Length 1	Restricts the length of the bar code that the scanner will read. Range is 0 to 255. Default is 6.
Length 2	Restricts the length of the bar code that the scanner will read. Range is 0 to 255. Default is 0.
Length 3	Restricts the length of the bar code that the scanner will read. Range is 0 to 255. Default is 0.

Japan Post Settings

This section lists all the configurable settings for decoding the Japan Post symbology.

Japan Post Settings and Descriptions

Setting	Description
Transmit check digit	Enables or disables transmission of the check digit as part of the bar code data. Default is disabled.
User defined symbology ID	Sets the symbology ID for Japan Post. Range is 1 to 4 ASCII characters. \xFF is not supported. Default is P5.

Japan Post Settings and Descriptions (Continued)

Setting	Description
Code mark	A one-character code mark that serves as an identifier for Japan Post. Default is *.

Matrix 2 of 5 Settings

This section lists all the configurable settings for decoding the Matrix 2 of 5 symbology.

Matrix 2 of 5 Settings and Descriptions

Settings	Descriptions
Start/Stop	Enables or disables a special bar code character that provides the scanner with start and stop reading instructions. Options include: <ul style="list-style-type: none"> • Regular (default) • ChinaPost
User defined symbology ID	Sets the symbology ID for Matrix 2 of 5. Range is 1 to 4 ASCII characters. \xFF is not supported. Default is B4.
Code mark	A one-character code mark that serves as an identifier for Matrix 2 of 5. Default is D.

Matrix 2 of 5 Length Mode Settings and Descriptions

Setting	Description
Mode	Sets the length mode for Matrix 2 of 5 decoding. Options include: <ul style="list-style-type: none"> • Length 1 minimum (default) • Lengths 1,2,3 fixed • Length 1 minimum, length 2 maximum
Length 1	Restricts the length of the bar code that the scanner will read. Range is 0 to 255. Default is 6.

Matrix 2 of 5 Length Mode Settings and Descriptions (Continued)

Setting	Description
Length 2	Restricts the length of the bar code that the scanner will read. Range is 0 to 255. Default is 0.
Length 3	Restricts the length of the bar code that the scanner will read. Range is 0 to 255. Default is 0.

Maxicode Settings

This section lists all configurable settings for decoding the Maxicode symbology.

Maxicode Settings and Descriptions

Setting	Description
Mode 0	Enables or disables Mode 0 for Maxicode. Default is disabled.
User defined symbology ID	Sets the symbology ID for Maxicode. Range is 1 to 4 ASCII characters. \xFF is not supported. Default is D2.
Code mark	A one-character code mark that serves as an identifier for Dutch Post. Default is *.

Micro PDF417 Settings

This section lists all configurable settings for decoding the Micro PDF417 symbology.

Micro PDF417 Settings and Descriptions

Setting	Description
Code 128 emulation	Enables or disables Code 128 emulation for Micro PDF417. Default is disabled.
User defined symbology ID	Sets the symbology ID for Micro PDF417. Range is 1 to 4 ASCII characters. \xFF is not supported. Default is C7.

Micro PDF417 Settings and Descriptions (Continued)

Setting	Description
Code mark	A one-character code mark that serves as an identifier for Micro PDF417. Default is *.

MSI Settings

This section lists all configurable settings for decoding the MSI symbology.

MSI Settings and Descriptions

Setting	Description
Verify check digit	Sets the check digit type. Options include: <ul style="list-style-type: none"> • Modulo 10 • Double Modulo 10 (default)
Transmit check digit	Enables or disables transmission of the check digit as part of the bar code data. Default is disabled.
User defined symbology ID	Sets the symbology ID for MSI. Range is 1 to 4 ASCII characters. \xFF is not supported. Default is B8.
Code mark	A one-character code mark that serves as an identifier for MSI. Default is D.

MSI Length Mode Settings and Descriptions

Setting	Description
Mode	Sets the length mode for MSI decoding. Options include: <ul style="list-style-type: none"> • Length 1 minimum (default) • Lengths 1,2,3 fixed • Length 1 minimum, length 2 maximum

MSI Length Mode Settings and Descriptions (Continued)

Setting	Description
Length 1	Restricts the length of the bar code that the scanner will read. Range is 0 to 255. Default is 6.
Length 2	Restricts the length of the bar code that the scanner will read. Range is 0 to 255. Default is 0.
Length 3	Restricts the length of the bar code that the scanner will read. Range is 0 to 255. Default is 0.

PDF417 Settings

This section lists all configurable settings for decoding the PDF417 symbology.

PDF417 Settings and Descriptions

Setting	Description
PDF with data length ID = 0	Enables or disables Irregular PDF to read bar codes with symbol length descriptor set to 0. Default is disabled.
User defined symbology ID	Sets the symbology ID for PDF417. Range is 1 to 4 ASCII characters. \xFF is not supported. Default is C7.
Code mark	A one-character code mark that serves as an identifier for PDF417. Default is *.

Macro PDF417 Setting and Description

Setting	Description
Transmit control header	Enables or disables transmission of the control header for Macro PDF417. Default is disabled.

Planet Settings

This section lists all configurable settings for decoding the Planet symbology.

Planet Settings and Descriptions

Setting	Description
Transmit check digit	Enables or disables check digit transmission. Default is enabled.
User defined symbology ID	Sets the symbology ID for Planet. Range is 1 to 4 ASCII characters. \xFF is not supported. Default is P1.
Code mark	A one-character code mark that serves as an identifier for Planet. Default is *.

Plessey Settings

This section lists all configurable settings for decoding the Plessey symbology.

Plessey Settings and Descriptions

Setting	Description
Transmit check digit	Enables or disables check digit transmission. Default is disabled.
Unconventional stop	Enables or disables decoding of Plessey bar codes that include variations (thicker or thinner bars) of the standard stop. Default is disabled.
User defined symbology ID	Sets the symbology ID for Plessey. Range is 1 to 4 ASCII characters. \xFF is not supported. Default is C2.

Plessey Settings and Descriptions (Continued)

Setting	Description
Code mark	A one-character code mark that serves as an identifier for Plessey. Default is D.

Plessey Length Mode Settings and Descriptions

Setting	Description
Mode	Sets the length mode for Plessey decoding. Options include: <ul style="list-style-type: none">• Length 1 minimum (default)• Lengths 1,2,3 fixed• Length 1 minimum, length 2 maximum
Length 1	Restricts the length of the bar code that the scanner will read. Range is 0 to 255. Default is 0.
Length 2	Restricts the length of the bar code that the scanner will read. Range is 0 to 255. Default is 0.
Length 3	Restricts the length of the bar code that the scanner will read. Range is 0 to 255. Default is 0.

Postnet Settings

This section lists all configurable settings for decoding the Postnet symbology.

Postnet Settings and Descriptions

Setting	Description
Transmit check digit	Enables or disables check digit transmission. Default is enabled.
User defined symbology ID	Sets the symbology ID for Postnet. Range is 1 to 4 ASCII characters. \xFF is not supported. Default is P0.

Postnet Settings and Descriptions (Continued)

Setting	Description
Code mark	A one-character code mark that serves as an identifier for Postnet. Default is *.

QR Code Settings

This section lists all configurable settings for decoding the QR Code symbology.

QR Code Settings and Descriptions

Setting	Description
Reverse video	Sets the video mode for decoding QR Code. Options include: <ul style="list-style-type: none"> • Normal (default): Decodes black bar codes printed on a white background • Inverse: Decodes white bar codes printed on a black background • Automatic: Decodes all QR Codes
User defined symbology ID	Sets the symbology ID for QR Code. Range is 1 to 4 ASCII characters. \xFF is not supported. Default is D1.
Code mark	A one-character code mark that serves as an identifier for QR Code. Default is *.

Standard 2 of 5 Settings

This section lists all configurable settings for decoding the Standard 2 of 5 symbology.

Standard 2 of 5 Settings and Descriptions

Setting	Description
Format	<p>Sets the number of start/stop bars to use for decoding Standard 2 of 5. Options include:</p> <ul style="list-style-type: none"> • Identicon, 6 s/s bars (default) • Comp Identics, 4 s/s bars
Verify check digit	<p>Enables or disables the optional check digit for a higher level of security. Options include:</p> <ul style="list-style-type: none"> • Disable (default) • Modulo 10
Transmit check digit	<p>Enables or disables transmission of the check digit as part of the data in a bar code.</p> <p>Default is disabled.</p>
User defined symbology ID	<p>Sets the symbology ID for Standard 2 of 5. Range is 1 to 4 ASCII characters. \xFF is not supported.</p> <p>Default is B5.</p>
Code mark	<p>A one-character code mark that serves as an identifier for Standard 2 of 5.</p> <p>Default is D.</p>

Standard 2 of 5 Length Mode Settings and Descriptions

Setting	Description
Mode	<p>Sets the length mode for Standard 2 of 5 decoding. Options include:</p> <ul style="list-style-type: none"> • Length 1 minimum (default) • Lengths 1,2,3 fixed • Length 1 minimum, length 2 maximum

Standard 2 of 5 Length Mode Settings and Descriptions (Continued)

Setting	Description
Length 1	Restricts the length of the bar code that the scanner will read. Range is 0 to 255. Default is 6.
Length 2	Restricts the length of the bar code that the scanner will read. Range is 0 to 255. Default is 0.
Length 3	Restricts the length of the bar code that the scanner will read. Range is 0 to 255. Default is 0.

Sweden Post Settings

This section lists all configurable settings for decoding the Sweden Post symbology.

Sweden Post Settings and Descriptions

Setting	Description
User defined symbology ID	Sets the symbology ID for Sweden Post. Range is 1 to 4 ASCII characters. \xFF is not supported. Default is P7.
Code mark	A one-character code mark that serves as an identifier for Sweden Post. Default is *.

Telepen Settings

This section lists all the configurable settings for decoding the Telepen symbology.

Telepen Settings and Descriptions

Setting	Description
Format	Sets the format. Options include: <ul style="list-style-type: none"> • ASCII (default) • Numeric: Must be an even number of digits

Telepen Settings and Descriptions (Continued)

Setting	Description
User defined symbology ID	Sets the symbology ID for Telepen. Range is 1 to 4 ASCII characters. \xFF is not supported. Default is C6.
Code mark	A one-character code mark that serves as an identifier for telepen. Default is *.

Telepen Length Mode Settings and Descriptions

Setting	Description
Mode	Sets the length mode for Telepen decoding. Options include: <ul style="list-style-type: none"> • Length 1 minimum (default) • Lengths 1,2,3 fixed • Length 1 minimum, length 2 maximum
Length 1	Restricts the length of the bar code that the scanner will read. Range is 0 to 255. Default is 0.
Length 2	Restricts the length of the bar code that the scanner will read. Range is 0 to 255. Default is 0.
Length 3	Restricts the length of the bar code that the scanner will read. Range is 0 to 255. Default is 0.

TLC 39 Settings

This section lists all the configurable settings for decoding the TLC 39 symbology.

TLC 39 Settings and Descriptions

Setting	Description
Linear only transmit mode	Enables or disables linear only transmit mode. When enabled, the computer only transmits the linear part of the bar code. Default is disabled.

TLC 39 Settings and Descriptions (Continued)

Setting	Description
ECI Security	Sets the security level used when reading TLC 39 bar codes if EDI has been found and Code 39 is enabled. The higher the value, the more secure the decoding, but higher values can interfere with decode speed. Range is 0 to 64. Default is 10.
User defined symbology ID	Sets the symbology ID for TLC 39. Range is 1 to 4 ASCII characters. \xFF is not supported. Default is H0.
Code mark	A one-character code mark that serves as an identifier for TLC 39. Default is *.

Configure the Scanner Decode Security Settings

You use the Settings app to set options for decode security. These settings ensure that the computer decodes bar codes correctly and securely.

- 1 Start the Settings app and tap **Scanners > Internal Scanner > Decode Security**.
- 2 Tap a setting in the list to change it. Your changes are automatically saved.

Decode Security Settings

This section lists the configurable decode security settings for the scanner.

Decode Security Settings

Setting	Description
Consecutive data validation	To increase decode security, you can set the number of times that the scanner automatically reads a bar code to ensure a valid read. Range is 0 to 10 scans. Default is 0.
Identical consecutive codes timeout	If you are scanning bar codes with identical data, this value sets the amount of time in milliseconds before a second bar code read is invalidated. Range is 0 to 2550. Default is 1000.
Different consecutive codes timeout	If you are scanning bar codes with different data, this value sets the amount of time in milliseconds before a second bar code read is invalidated. Range is 0 to 2550. Default is 0.
Center decoding	Enables or disables center decoding. When enabled, the scanner reads only the bar code located in the aiming beam. Use this feature to read bar codes positioned close together. Default is disabled.
Center decoding tolerance	Allows you to aim the scanner close to the bar code you want to read, instead of requiring you to place the aiming beam directly on the bar code. Range is 0 (scanner must be positioned on the bar code to read it) to 100 (scanner must be positioned beside the bar code to read it). Default is 0.

Set a Preamble, Postamble, or Symbology Identifier

You use the Settings app to set the preamble, postamble, and symbology identifier type for decoding.

- Preamble and postamble strings are applied to all successful reads.
- If you enable the code mark or user-defined symbology identifier, you need to specify the string in the decode settings for that symbology.

- 1 Start the Settings app and tap **Scanners > Internal Scanner > Symbology Options**.

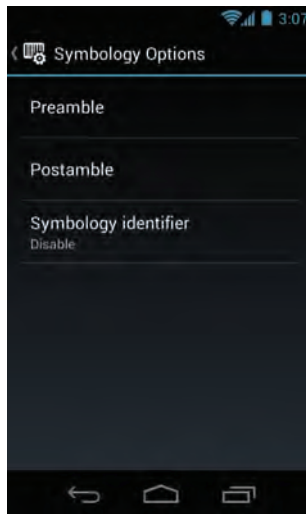

- 2 Tap **Preamble** or **Postamble**, use the onscreen keypad to type the preamble or postamble string, and tap **OK** when you are done.

To set the symbology identifier type, in the **Symbology Options** list tap **Symbology identifier** and select an option in the list. Your changes are automatically saved.

Set the Scanner Trigger or Aimer Mode

You use the Settings app to set the trigger and aimer modes for the scanner. You can also select how the imager behaves after a good read.

- 1 Start the Settings app and tap **Scanners > Internal Scanner > Scanner Settings**. Hardware triggering is enabled by default.
- 2 Tap a setting in the list to change it. Your changes are automatically saved.

Scanner Settings

This section lists the configurable trigger and aimer mode settings.



Note: For these settings, pressing the **Scan** button on the computer is the same as pulling the trigger on the scan handle accessory.

Trigger and Aimer Mode Settings

Setting	Description
Hardware trigger	Enables or disables the scanner (or an external scanning device) without affecting communication to the computer. When disabled, nothing happens when you press the Scan button. For tethered scanners, the laser or imager beam may turn on, but no data is read. Default is enabled.

Trigger and Aimer Mode Settings (Continued)

Setting	Description
Trigger mode	<p>Sets the behavior of the scanner when you press the Scan button:</p> <ul style="list-style-type: none"> • Level (default): The scanner turns on and stays on until you release the Scan button. • Pulse: The scanner turns on and stays on until the end of the trigger timeout. • Flashing: The scanner turns on and stays on while looking for a bar code to read. At the end of the trigger timeout, the beam starts flashing. When the scanner reads a bar code, it restarts the trigger timeout. If you press the Scan button again, the scanner turns off. • Autostand: Switches between Level and Flashing modes. The first time you press the Scan button, the scanner turns on in Flashing mode. To switch to Level mode, press the Scan button again. • Toggle: The scanner turns on and stays on, and does not read a bar code until you release the Scan button.
Aimer mode	<p>Enables or disables the aimer activation feature. Options include:</p> <ul style="list-style-type: none"> • Typical aimer • One pull aim and read • One pull aim, second pull read
Turn off after good read	<p>Defines how the scanner operates when you press Scan to read a bar code. Options include:</p> <ul style="list-style-type: none"> • Disable/Auto-trigger: Press Scan once to scan a series of bar codes. When you release the Scan button, the scanner turns off. To scan the same bar code more than once, you must release the button, read a different bar code before trying a second read, or wait until the identical consecutive timeout is over. • Enable/One-shot: You must press Scan each time you want to read a bar code. After the read, the scanner turns off.

4

Use the Phone

You can use the phone feature to make and receive telephone calls, as well as transmit data through cellular wide-area networks (WANs).

About the Phone

Phone features on the computer include a speaker and a microphone. You can also use a Bluetooth headset or hands-free kit. The phone feature is enabled by default.

The WAN radio in your computer determines the supported network types:

- If your computer includes the UMTS/HSPA+ WAN radio, you can connect to UMTS networks.
- If your computer includes the Flexible Network Radio, you can connect to CDMA or UMTS networks in all regions that support these technologies. The Flexible Network Radio is a software-defined radio (SDR) that can be configured for CDMA or UMTS depending on your wireless communication needs.

Intermec supports these CDMA network carriers:

- Sprint (United States only)
- Verizon (United States only)

For other carriers, contact Intermec Product Support.

After you turn on the phone and activate service with your wireless carrier, you can customize the phone features and network settings in the Wireless & Networks section of the Settings app.



Note: Both WAN radios support Network Information and Time Zone (NITZ) messages to automatically set the system time.

Activate the UMTS Phone

Activating the UMTS phone on your CN51 is done the same way whether your computer has the Flexible Network Radio or the UMTS/HSPA+WAN radio.

You use a SIM card to activate the UMTS phone on the CN51. You can purchase the SIM card from your network provider.

- 1** Press  to turn off the CN51.
- 2** Disconnect the handstrap from the top of the computer.
- 3** Push forward on the battery release tab until the battery releases, and then lift the battery away from the computer.

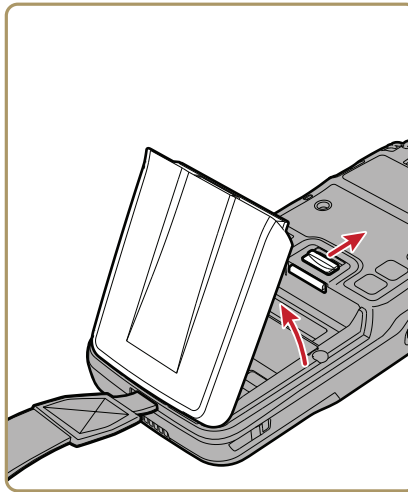

- 4 Open the card access door and slide the SIM card holder to the left to open it.

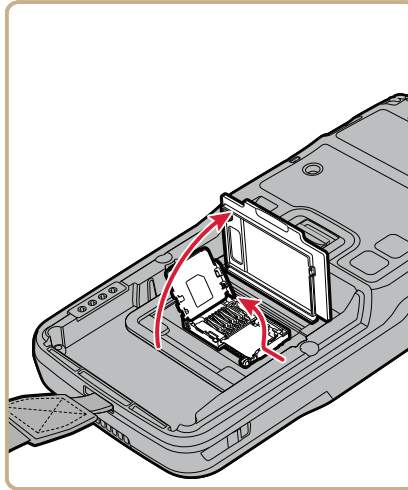

- 5 Place the SIM card in the holder.

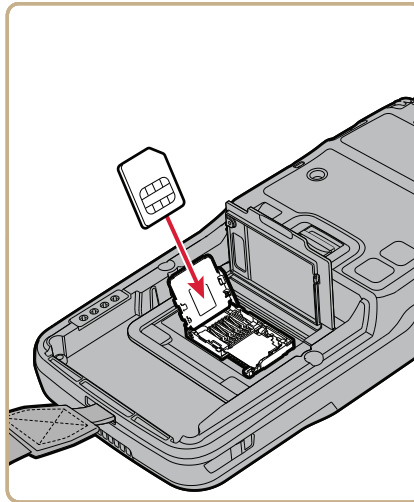

- 6 Close the SIM card holder and slide it to the right to secure it, and then close the card access door.

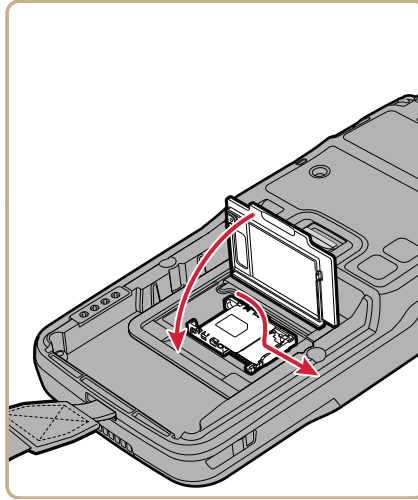

- 7 Insert the battery and press down until it clicks in place.
- 8 Reconnect the handstrap.
- 9 Press **Ⓜ** to turn on the CN51. The phone is now ready to use.

Activate the CDMA Phone

To activate the CDMA phone in your mobile computer, you need to contact your wireless carrier and set up an account.

You also need to provide the carrier with the Mobile Equipment Identifier (MEID) for the computer. You can find the MEID:



- on a label located in the battery compartment.
- on the outside of the computer shipping box.



Note: For the CDMA phone, settings are permanently stored in the WAN radio after activation. CDMA settings persist through a factory data reset.





The activation process is slightly different for each CDMA carrier. Your carrier sales contact and an Intermec representative can guide you through the process. In general, you activate the CDMA phone as follows:

- 1** Contact your wireless provider and give the provider the MEID for the computer.
- 2** If your carrier is Sprint, reboot the computer. As soon as the Sprint network detects your phone, Hands-Free Activation (HFA) begins, and a series of notification messages appear. When activation is complete, a completion message appears and the WAN radio reboots. The phone is ready to use.

If your carrier is Verizon, tap , enter *228 on the phone keypad, and tap . After a short wait, a message appears, confirming either success or failure of the activation. After successful activation, the phone is ready to use.

Make a Phone Call

Once the phone is activated, you can make a phone call.

- 1** On the Home or All Apps screen, tap .
If the Phone app opens to a list of numbers instead of the keypad, swipe left or touch  to return to the keypad.
- 2** Touch the keys to enter the number, and then touch  below the keypad to dial.
- 3** To end a call in progress, tap .

Answer the Phone

When you receive a phone call, the Incoming Call screen opens, showing the caller ID. All incoming calls are recorded in the Call log. If you miss a call, you receive a notification.

- When a call arrives, touch the white phone icon and slide over one of the icons:

To answer the call: 

To send the call to voicemail: 

To send a message from a list of default text messages: 

Send a Call to Voicemail

When you receive an incoming call, you can send the call to voicemail instead of answering it.

- When a call arrives, touch the white Phone icon and slide over  to send the call to voicemail.

Switch Apps During a Phone Call

You can switch apps while a phone call is in progress. For example, you can use the People app to look up contact information during your call.



Note: If you have only a WAN connection, apps that need a data connection may be unable to access online data while the phone call is in progress. If simultaneous phone calls and data connections are not possible due to provider limitations, voice calls receive priority. Check with your provider for more information.

- During a phone call, tap another app icon on the Home or All Apps screen to run that application. The green Phone icon appears in the Status bar while the call is underway.

Check Your Voicemail

When you have a new voicemail message, the voicemail icon appears at the top left of the screen.



Note: Consult your service provider for more information on setting up your voicemail account.



- 1 Swipe down from the top of the screen to view your notifications. The voicemail notification shows the number of unread messages and a number to dial.
- 2 Touch **New voicemail**. The phone dials the number. Follow the instructions to retrieve your messages.

Set Your Voicemail Number



To access your voicemail, you must set your voicemail number in the Phone app.



Note: Verizon customers do not need to follow this procedure.

- 1 Tap .
- 2 Tap  and then tap **Settings**. A list of call settings appears.
- 3 Tap **Voicemail > Setup > Voicemail number**.
- 4 If you are a Sprint customer, delete “*86” from the entry field and enter your voicemail number.
If you are an AT&T customer, enter your voicemail number.
- 5 Tap **OK**.

Change Voicemail Settings

- 1 Tap  on a Home or All Apps screen.
- 2 Tap  and then tap **Settings**.
- 3 Tap the voicemail setting you want to change.

Make an Emergency Phone Call

You can use the phone to make an emergency phone call, even if the SIM card is missing from your UMTS phone or if you do not have a valid CDMA account. In either case, the phone shows that you have no service. However, if you dial certain emergency numbers (such as 112, 911, 000, 08, 118, 119, or 999) the call will go through.

Switch Between Network Carriers

If your computer includes the Flexible Network Radio, you can easily add carriers and switch between them as needed.

- 1 In the All Apps screen, tap **Carrier Selection**.

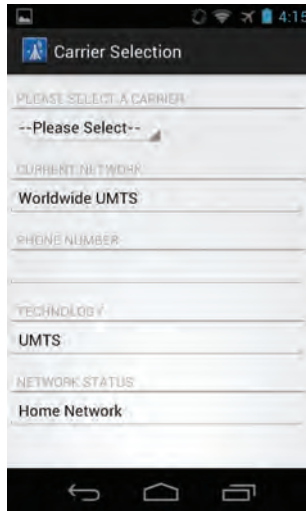

- 2 Select a different carrier from the **Please select a carrier** list.

About Internet Calling



You can configure the phone to place calls over a Wi-Fi network connection, instead of through your mobile network. The computer must be connected to a Wi-Fi network before you can make calls this way.



Note: Support for this feature depends on your network provider.



Set Up Internet Calling

Before you can use the phone for Internet calling, you must configure SIP (Session Initiation Protocol) accounts.

- 1 Tap .
- 2 Tap  and then tap **Settings**. The Call settings menu appears.
- 3 In the Internet Call Settings section, tap **Use Internet calling** and select an option from the list.
- 4 In the Internet Call Settings section, tap **Accounts**.
- 5 To receive incoming calls through Internet calling, select **Receive incoming calls**.
- 6 To add an account, tap **Add Account** and enter the required information in the SIP account details list.
- 7 Tap **Save**.

Add Contacts for Internet Calling

After you set up Internet calling, add SIP addresses for the contacts you want to call using this method.



- 1 Tap Contacts .
- 2 Tap the phone number you want to call using Internet calling. The contact information appears.
- 3 Tap  and then tap **Edit**.
- 4 Scroll to the bottom of the screen and tap **Add another field**.

5 In the list that appears, tap **Internet call**.

6 Tap **Done**.

Configure Phone Settings

You can customize settings for the phone, including the ringtone, voicemail options, keypad tones, internet call settings, and other options.

- 1 Tap .
- 2 Tap  and then tap **Settings**. The Call settings menu appears.
- 3 Change phone settings as necessary.

Phone Settings

This section lists all the configurable phone settings. Some features may not be available depending on your network carrier.

Ringtone Settings and Descriptions

Setting	Description
Phone ringtone	Sound that plays when a call is received.
Vibrate when ringing	When enabled, the computer vibrates when a call is received.

Other Call Settings and Descriptions

Setting	Description
Voicemail	Voicemail account settings. Options include: <ul style="list-style-type: none"> • Service • Setup: Voicemail number • Ringtone • Vibrate: Enables vibration when a call is sent to voicemail.
Dial pad touch tones	Enables or disables sound that plays when you press keys on the phone keypad.

Other Call Settings and Descriptions (Continued)

Setting	Description
Quick responses	Edit the default text messages you can send to a caller.
Fixed Dialing Numbers	Enable or disable Fixed Dialing Numbers, which limits outgoing calls to only a specific list of phone numbers. Options include: <ul style="list-style-type: none">• Enable FDN: Default is disabled.• Change PIN2: Create or edit the PIN required to access the list of FDNs.• FDN list: List of FDNs.
Call forwarding	Set options for call forwarding, including: <ul style="list-style-type: none">• Always forward (default is disabled).• Forward when busy (default is disabled).• Forward when unanswered (default is disabled).• Forward when unreachable (default is disabled).
Additional settings	Set Caller ID and call waiting options.

Internet Call Settings and Descriptions

Setting	Description
Accounts	Enables or disables reception of incoming calls through the Internet. Enabling this feature reduces battery life.
SIP Accounts	Lists the available SIP accounts.

5

Use the Camera



Learn to use the color camera to take pictures and record videos.

About the Color Camera

The computer includes a 5.0-megapixel camera for taking pictures and videos. The camera and flash are located on the back of the computer.



You can view photos and videos in the Gallery app .





Take a Picture

- 1 In the All Apps screen, tap **Camera** .
- 2 Using the screen as a viewfinder, move the computer until you see the image you want to take a picture of.
- 3 Tap the screen to set the focus. By default, the camera senses the lighting in the environment and turns the torch on if needed.
(Optional) To zoom in or out, drag the slider at the bottom of the viewfinder.
- 4 Press **Enter** or the shutter button . The camera takes a picture and a thumbnail image of the picture appears in the corner of the screen.
 - To view the picture, tap the thumbnail image.
 - To return to the Camera app, swipe the thumbnail image to the right.

Change Camera Settings for Taking Pictures





You can change the camera settings for best results when taking pictures.

- 1 In the All Apps screen, tap **Camera** .
- 2 Tap .

- 3** Tap  to change basic camera settings:
 - Store Location: Enable this feature to save location data for each picture.
 - Picture size: Sets the maximum size (in pixels or as a screen size) of each image. Default is 5 MP.
 - Metering modes: Sets how the camera measures the brightness of the subject based on a specific region of the image, and adjusts the exposure accordingly. Default is Center.
 - Self-Timer: Sets the amount of time the camera waits to take the picture after you press the . Default is Off (self-timer is disabled).
 - Multi shot: Sets the number of pictures the camera takes when you press the shutter button. Default is Off (Multi shot is disabled, and the camera takes only one picture at a time).
- 4** (Optional) To select a Scene, tap **SCN**. Scenes are preconfigured sets of values for white balance and flash that are optimized for specific environments:
 - Auto
 - Action
 - Night
 - Sunset
 - Party
- 5** To set the exposure, tap  and select a value from the list. Default is 0.
- 6** To set the white balance, tap  and select a value from the list. Default is Auto.
- 7** To set the flash mode, tap  and select an option from the list. Default is Auto.







Record a Video

This section explains how to record video with the camera in the computer.

- 1 In the All Apps screen, tap Camera .
- 2 Tap .
- 3 Tap  to begin recording video. To zoom in or out, drag the slider at the bottom of the viewfinder.
- 4 When you are done recording, tap .

Change Video Settings

You can change the camera settings for best results when recording video.

- 1 In the All Apps screen, tap **Camera** .
- 2 Tap .
- 3 Tap  to enable or disable location data. To enable **Store Location**, slide the switch on. When Store Location is enabled, location data is saved with the file.
- 4 Tap the current video quality setting (**1080p**, **720p**, or **480p**) to change the video quality. Default is 720p.
- 5 To change the time lapse interval between images in the video, tap . Default is Off (no time lapse between images).
- 6 To change the background effects, tap  and select an option from the list.
- 7 To set the white balance, tap  and select a value from the list. Default is Auto.
- 8 To set the flash mode, tap  and select an option from the list. Default is Auto.

6

Configure the Computer

Use this chapter to learn about the available methods for configuring your computer . You can also use this chapter to learn how to configure network communications and wireless security.

How to Configure the Computer

You can configure many parameters on the computer such as the bar code symbologies it decodes, or the network settings. The values you set for these parameters determine how the computer operates.

You configure the computer using the Settings app.

Start the Settings App

The Settings app is located in the All Apps menu.

- Tap **All Apps > Settings**.

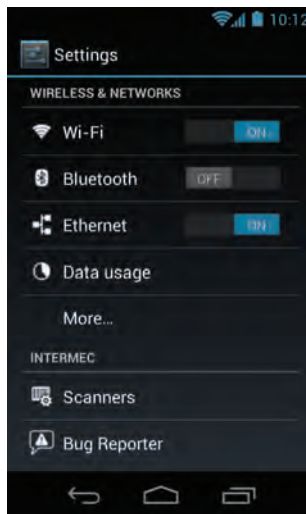

About the Structure of the Settings App

Use this section to learn about the structure of the Settings app so you can find parameters quickly.

Wireless & Networks

Setting	Description
Wi-Fi	Turns the Wi-Fi radio on and off. When Wi-Fi is turned on, tap the bar to see a list of Wi-Fi networks.
Bluetooth	Turns the Bluetooth radio on and off. When Bluetooth is turned on, tap the bar to see a list of Bluetooth devices in range.

Wireless & Networks (Continued)

Setting	Description
Data usage	Displays a list of phone data usage for the current data usage cycle. Tap the Data usage cycle list to select another date range.
More	<p>Airplane mode: Turns airplane mode on and off.</p> <p>VPN: Sets the password parameters for a virtual private network (VPN).</p> <p>Tethering & portable hotspot: Allows you to use the computer as a portable Wi-Fi hotspot and enables Bluetooth or USB tethering.</p> <p>Mobile networks: Includes settings for mobile networks, including enabling data access and roaming over mobile networks, selecting access points and network operators, or selecting only 2G networks (to save battery life).</p>

Intermec

Setting	Description
Scanners	<p>Internal Scanner: All settings for the scanner, including bar code symbology decode options, trigger modes, and security.</p> <p>Virtual Wedge: Enables or disables the virtual wedge, which sends bar code data to an application as keyboard input.</p> <p>Security: Enables or disables the ability to launch a website when you scan a bar code containing URL data. Also enables or disables scanner control from web applications.</p>
Bug Reporter	<p>Enables automatic error reports.</p> <p>Contact Intermec Product Support before you enable Bug Reporter. Because error reports may include screenshots or other large files, automatic error reporting increases your data usage. Do not enable reporting through your mobile network unless specifically instructed to do so by Intermec personnel.</p>

Device

Setting	Description
Sound	Settings for the phone and notification sounds, including tones and volume.
Display	Settings for the display brightness, wallpaper, sleep timeout, font size, and screen auto-rotation.
Storage	Shows the remaining amount of storage.
Battery	Shows battery usage data and the current battery state.
Apps	Lists downloaded and running apps.

Personal

Setting	Description
Location services	Turns location services (Google and GPS satellite data) on and off.
Security	Sets screen lock and administrator privileges.
Language & input	Selects the active language and default keyboard. Sets auto-typing features such as capitalization and punctuation. Adjusts the pointer speed for an external mouse or trackpad.
Backup & reset	Restores factory default settings.

Accounts

Setting	Description
Add account	Adds a Corporate or Email account to this computer.

System

Setting	Description
Date & time	Configures all date and time settings.
Accessibility	Sets accessibility levels, such as larger display text and enabling text-to-speech output.
Developer options	Enables developer-specific options such as USB debugging and SD card protection.

System (Continued)

Setting	Description
About phone	Lists device-specific settings including the phone number, operating system version, and build number.

About Network Communications

You can use the mobile computer in your wireless or wired data collection network. You can connect your computer using:

- 802.11 radio communications.
- Ethernet communications.
- Bluetooth communications.
- USB and serial communications.

Connect to a Wi-Fi Network



The CN51 has an 802.11 radio to transfer data using wireless communications. Before you connect to a Wi-Fi network, you need to know about your network security protocol and its required credentials.

By default, the 802.11 radio is disabled.

- 1 Start the Settings app and slide the Wi-Fi switch on.

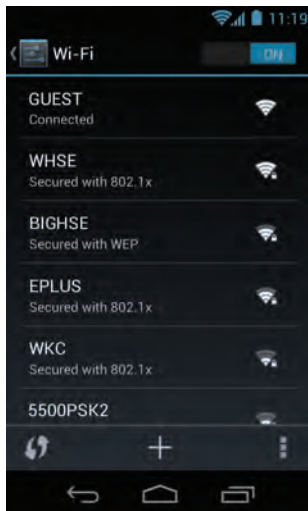
- 2 When the switch turns blue, tap **Wi-Fi**. A list of discovered networks appears.



- 3 To quickly connect to a network through Wi-Fi Protected Access (WPS), tap . To search for a network not in the list, tap  and type the network name.

- 4 Tap a network name in the list to view details:

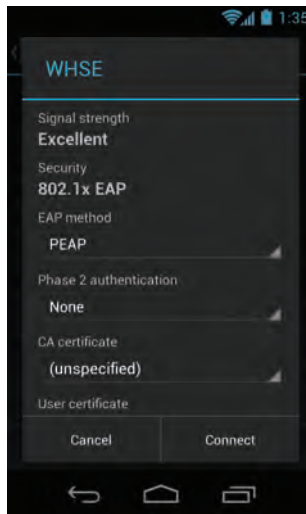

If the network is secured, a list of required information appears (such as a certificate name, a password, or other credentials). To connect to the secured network, enter the required information and tap **Connect**.

To leave a connected network, tap **Forget**. For example, you could choose to forget a network you no longer use.

To close the network details screen, tap **Cancel**.

Configure Proxy Settings for a Wi-Fi Network

If you need to connect to network resources through a proxy server, you can configure settings for the proxy server for each Wi-Fi network you add. By default, the Wi-Fi networks you add are not configured to connect through a proxy server.



Note: Proxy settings apply only to the Wi-Fi network you modify. You must change proxy settings for each network requiring a proxy server.

- 1 Open the Settings app and tap **Wi-Fi**. The list of available Wi-Fi networks appears.
- 2 Tap and hold the network name and then tap **Modify network**. A list of network settings appears.

- 3 At the bottom of the list of network settings, select **Show advanced options**.
- 4 If the network has no proxy settings, tap **None** in the Proxy Settings list, and then tap **Manual** in that list.
- 5 Enter the proxy settings for the network.
- 6 Tap **Save**.

Disable Wi-Fi Notifications

By default, when Wi-Fi is enabled, you receive notifications in the Status bar when the computer discovers a wireless network. You can disable these notifications.

- 1 Start the Settings app.
- 2 Tap and hold **Wi-Fi**.
- 3 Tap  and then tap **Advanced**. The Advanced Wi-Fi menu appears.
- 4 Clear the **Network notification** check box to disable notifications.

Connect to an Ethernet Network

To connect the computer to an Ethernet network, you need an Ethernet dock.

- 1 Make sure the dock is connected to your Ethernet network.
- 2 Place the computer in the dock.
- 3 Start the Settings app and make sure Ethernet is enabled (Ethernet is enabled by default).

To enable Ethernet, slide the Ethernet switch on. When the switch turns blue, Ethernet is enabled.

- 4 Tap **Ethernet**. The Ethernet list shows the name of the current Ethernet connection. By default, the computer assumes a DHCP connection, and that your network has assigned an IP address automatically. If DHCP is working, the Ethernet dock should indicate that communication with the network is occurring.

- 5 (Optional) To assign a static IP address, tap the connection name (for example, eth0). The IP settings dialog box appears.
 - a Tap **DHCP** and then select **Static** from the list.
 - b Enter the required network information and then tap **Apply**.

How to Connect to Virtual Private Networks

The computer supports connecting to virtual private networks (VPNs). This section describes how to add and connect to VPNs.

To configure VPN access, you must obtain details from your network administrator. You view and change VPN settings in the Settings app.



Note: Before you can access VPNs, you must set a screen lock method.

Add a VPN

Before you can connect to a VPN, you must add VPN information.



Note: Before you can add or connect to a VPN, you must set a screen lock method.

- 1 Start the Settings app.
- 2 In the Wireless & Networks section, tap **More**.
- 3 Tap **VPN**.
- 4 Tap **Add VPN Profile**.
- 5 Enter information for the VPN.
- 6 Tap **Save**. The VPN name appears in the VPN list.

Connect to a VPN

- 1 Start the Settings app.
- 2 In the Wireless & Networks section, tap **More**.
- 3 Tap **VPN**.
- 4 Tap the name of the VPN in the list, and enter any necessary credentials when prompted.

- 5 Tap **Connect**. The computer connects to the VPN, and a Status icon and notification appear.

To disconnect from the VPN, tap the notification.

Edit VPN Information

- 1 Start the Settings app.
- 2 In the Wireless & Networks section, tap **More**.
- 3 Tap **VPN**.
- 4 Tap and hold the name of the VPN you want to edit, and select **Edit network** from the list.
- 5 Edit VPN settings as necessary.
- 6 When you are done, tap **Save**.

About Wireless Security

The computer provides these security solutions for your wireless network:

- Wi-Fi Protected Access 2 (WPA2™)
- Wi-Fi Protected Access (WPA)
- 802.1x
- LEAP
- WEP

Intermec recommends WPA2 security with PSK (Personal) or 802.1x (Enterprise) key management.

Before you set security, you need to enable the radio, set the date, and set the SSID on your computer. To use 802.1x security, you need to load a root certificate on your computer. To use transport layer security (TLS) with 802.1x security, you also need to load a user certificate.

Configure Wireless Security

Use the Settings app to access and configure all wireless security settings.

About Certificates

You can use digital certificates to identify the computer for network access or authentication to servers. To use a certificate to identify your device, you must install it in the trusted credential storage on the computer.

Android supports DER-encoded X.509 certificates saved in files with a .crt or .cer file extension. To install a valid certificate with a .der or other extension, you must change the extension to .crt or .cer to install it.

Android also supports X.509 certificates saved in PKCS#12 key store files with a .p12 or .pfx extension. To install a valid key store file with another extension, you must change the extension to .p12 or .pfx to install it. When you install a certificate from a PKCS#12 key store, Android also installs any accompanying private key or certificate authority certificates.

Load a Certificate

To use a certificate, you must install it in the trusted credential storage on the computer.

- 1 Copy the certificate or key store from your PC to a microSD card.
- 2 Install the microSD card in the computer and turn the computer on.
- 3 Start the Settings app and tap **Security > Install from SD card**.
- 4 Tap the name of the certificate or key store to install it. If prompted, enter the key store password and tap **OK**.
- 5 Enter a name for the certificate and tap **OK**.



Note: Apps such as Email and Browser that support certificates allow you to install certificates directly from within the app. For more information, see the Help that comes with the app.

Disable or Remove Certificates

If a certificate is compromised, or your organization chooses not to trust it, you can disable or remove it.

- 1 Start the Settings app and tap **Security > Trusted credentials**.

The trusted credentials screen has two tabs:

- **System** shows CA certificates that are installed in the ROM.
- **User** shows CA certificates you have installed yourself.

- 2 Tap the name of the certificate to disable or remove. The certificate details screen appears.

- 3 Scroll to the bottom of the details screen and tap **Disable** (for System certificates) or **Remove** (for User certificates).



Note: If necessary, you can enable a disabled System certificate from this location. If you remove a User certificate, you must install it again to enable it.

- 4 Tap **OK**.

About Bluetooth Communications

The CN51 is Bluetooth-enabled, which lets you connect to other Bluetooth devices.

You need to turn on the Bluetooth radio before you can discover and connect to Bluetooth devices. By default, the radio is turned off.

The Bluetooth radio maintains its current state through a system reset. If you perform a factory data reset, you must recreate pairings to devices.

System bar icons indicate Bluetooth status.

Connect a Bluetooth Device

To connect to a Bluetooth device, you must enable Bluetooth and then select the device from a list of discovered devices.

- 1 Start the Settings app.
- 2 If Bluetooth is off, slide the Bluetooth switch on.
- 3 Tap **Bluetooth**. A list of available Bluetooth devices appears.

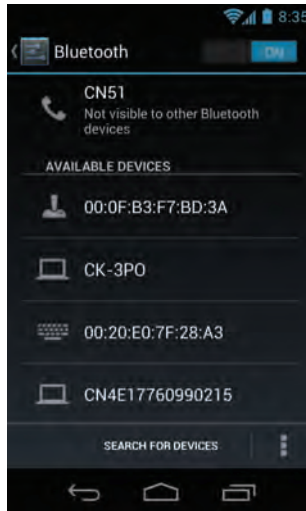

- 4 (Optional) If the device you want does not appear in the list, make sure the device is turned on and discoverable, and tap **Search for devices**.

- 5 Tap a device in the list to select it. If a pairing request message appears, enter the device PIN and tap **OK**. When the device is paired with the computer, the device name appears in **Paired Devices** at the top of the list.

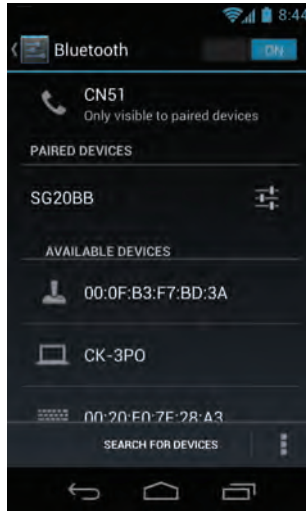

- 6 To disconnect a paired device, tap the Quick Settings icon  next to the device name and then tap **Unpair**.

Configure Bluetooth Settings

You configure Bluetooth settings in the Settings app.

- 1 Start the Settings app and tap **Bluetooth**.
- 2 Tap the Menu icon  and select a setting from the menu:
 - Tap **Rename phone** to change the computer device name. Type the new name and then tap **Rename**.
 - Tap **Visibility timeout** to set the amount of time that the computer is visible to other Bluetooth devices. By default, the timeout is set to 2 minutes. You can select 5 minutes, one hour, or no timeout. Setting a shorter timeout value preserves battery life.

Rename or Disconnect a Paired Device

You can rename or disconnect a paired Bluetooth device from the Settings app.

- 1 Open the Settings app and tap **Bluetooth**.
- 2 Tap the Settings icon  in the **Paired Devices** list.
- 3 To rename the device, tap **Rename**, type the new name, and then tap **OK**.

To disconnect the device, tap **Unpair**.

View a List of Received Files

You can view a list of files received through the computer's Bluetooth connections with other devices.

- 1 Start the Settings app.
- 2 Tap Bluetooth and then tap the Menu icon .
- 3 Tap **Show received files**. A list of files received through the Bluetooth connection appears.

About Serial and USB Communications

You can use these accessories to transmit data to and receive data from another device through serial or USB communications:

- AV10 vehicle dock
- AA21 RS-232 adapter
- AD27 single dock
- Desktop USB adapter
- USB snap-on adapter
- RS-232 DEX adapter

For information on these accessories, contact your local sales representative.

How to Share Your Mobile Data Connection

You can share the mobile data connection through USB tethering or Bluetooth tethering. You can also use the computer as a Wi-Fi hotspot to share the connection with other devices.

Share the Data Connection Through USB

After you connect the computer to another device through USB, you can share the data connection through USB tethering.

- 1 Connect the mobile computer to another device through a USB dock, cable, or other connection.
- 2 Start the Settings app.
- 3 In the Wireless & networks section, tap **More** and then tap **Tethering & portable hotspot**.
- 4 Tap **USB tethering**. The device is now sharing the computer data connection.

To stop sharing the connection, disconnect the USB cable, or clear the check box for USB tethering.

Share the Data Connection Through Bluetooth

If your device is Bluetooth-capable, you can configure the computer to share its mobile data connection with the device through Bluetooth.

- 1 Start the Settings app.
- 2 In the Wireless & networks section, tap **More** and then tap **Tethering & portable hotspot**.
- 3 Tap **Bluetooth tethering**. You should now be able to pair your device with the computer to share the data connection.

To stop sharing the data connection, clear the check box for **Bluetooth tethering**.

Share the Data Connection as a Portable Hotspot

You can configure the computer to act as a portable Wi-Fi hotspot for up to eight other devices.

- 1 Start the Settings app.
- 2 In the Wireless & networks section, tap **More** and then tap **Tethering & portable hotspot**.
- 3 To share the data connection as a Wi-Fi hotspot, tap **Portable Wi-Fi hotspot**. The computer begins to broadcast its network name (SSID) so you can connect to it with up to eight other devices.

To restrict access to the computer when you are using it as a Wi-Fi hotspot, tap **Set up Wi-Fi hotspot** to select the security protocol and set up a password. When other devices try to connect to the hotspot, users are prompted to enter the password before the devices are allowed to connect. Or, to remove secure access, select **Open** from the Security list.

- 4 Touch **Save**.

7

Manage the Computer

Use this chapter to learn how to remotely update, configure, and monitor your Intermecc computers. You will also find information on installing and developing software applications as well as how to upgrade the system software.

How to Transfer Files

To transfer files you need to physically connect the mobile computer to your desktop PC through a USB connection. When the computer is connected through USB, you can browse to it and drag-and-drop to move files back and forth to a Windows PC. If you are transferring files to and from a Mac, use the Android File Transfer application (available from www.android.com/filetransfer).

By default, the computer connects using MTP (Media Transfer Protocol). If you are transferring mainly camera images, you can configure the connection to use PTP (Picture Transfer Protocol). If your Windows PC does not support MTP, you may be able to transfer files using PTP instead.

Connect to a PC through USB

You can use a USB cable and dock to connect the computer to a Windows PC to transfer files in both directions. If you are using USB tethering, you must turn tethering off before you can transfer files through USB.

- 1 Place the computer in a USB dock.
- 2 Connect the dock to your Windows PC. The mobile computer is mounted as a drive, and you can copy files in either direction as needed.
- 3 When you are done transferring files, disconnect the CN51.

Configure the USB Connection for PTP

By default, the CN51 connects through USB using MTP (Media Transfer Protocol), supported by Windows 7 and later. If you are transferring mainly camera images, you can configure the connection to use PTP (Picture Transfer Protocol). If your computer does not support MTP, you may be able to transfer files using PTP instead.



Note: PTP is supported by Windows XP and later. Your Windows XP computer may also support MTP if it also supports Microsoft Media Player 10.

- 1 Start the Settings app and tap **Storage**.
- 2 Tap .
- 3 Tap **USB computer connection** and then select **Camera (PTP)**.

How to Develop and Install Applications

You need the Android SDK, the Intermec SDK Addon, and Intermec SDKs for Android to develop applications for the CN51 running Android.

To download and install the Android SDK, visit developer.android.com/sdk/index.html. After you install the Android SDK, you use SDK Manager to download and install the Intermec SDK Addon.

Use the Intermec SDKs for Android to develop applications for the computer. The SDKs can be downloaded from the Intermec website at www.intermec.com/idl.

The SDKs are libraries of Java components grouped by functionality. Intermec SDKs for Android include:

- **Data Collection:** Provides functionality for using the imager in your application.
- **Printing:** Provides text-based report printing functionality for your application.

After you develop applications, you can install the apps using:

- ScanNGo bar codes.
- management applications.
- web installs.
- ADB push to the device.

For more information on developing and installing applications, see developer.android.com.

Download the Intermec SDKs for Android

You can download the Intermec SDKs for Android from the Intermec website.



Note: To ensure you install the most recent version of the SDK, and for easy version control, Intermec recommends you download and install the SDKs using the Android SDK Manager.

- 1 Go to www.intermec.com.
- 2 Select **Support > Downloads**.
- 3 In the Product Category list, select **Software and Tools**.
- 4 In the Product Family list, select **Developer Library**.
- 5 In the Product list, select **SDKs for Android** and then click **Submit**.
- 6 Click the SDK name and follow the prompts to download the SDK. You need to log in to download software.

Install the Intermec CN51 SDK Add-on with the SDK Manager

You use the Android SDK Manager to download and install the Intermec CN51 SDK add-on software on your development PC. You must install the Android SDK to use the SDK Manager. For more information, visit developer.android.com.



Note: If you already downloaded the Intermec SDKs for Android from the Downloads page at www.intermec.com, unzip the package to a location on your development PC. However, to ensure you install the most recent version of the package, and for easy version control, Intermec recommends you install the package as described in this procedure.

- 1 On your development PC, start Android SDK Manager.
- 2 Click **Tools > Manage Add-on Sites** and then click the **User-Defined Sites** tab.
- 3 Click **New**.
- 4 Enter this text:

```
http://sdk.android.intermec.com:60093/sdk/addon.xml
```

- 5 Click **OK** and then click **Close**. The Intermec CN51 SDK add-on is added to the list of items for Android 4.2.2 (API17).
- 6 In the Android 4.2.2 section, select the packages you want to install, including **Intermec CN51 (API17)**.

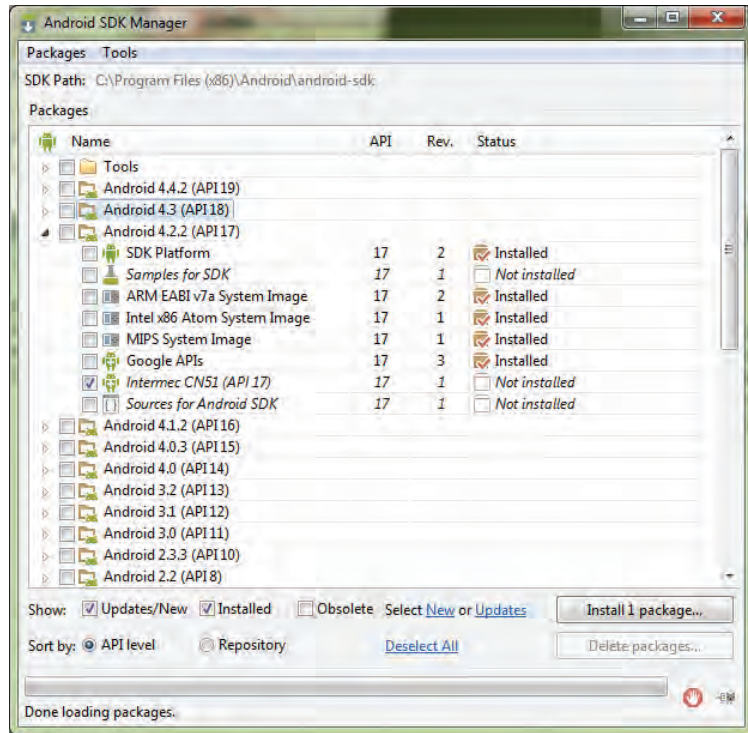

7 In the Extras section, select **Intermec USB Driver**.

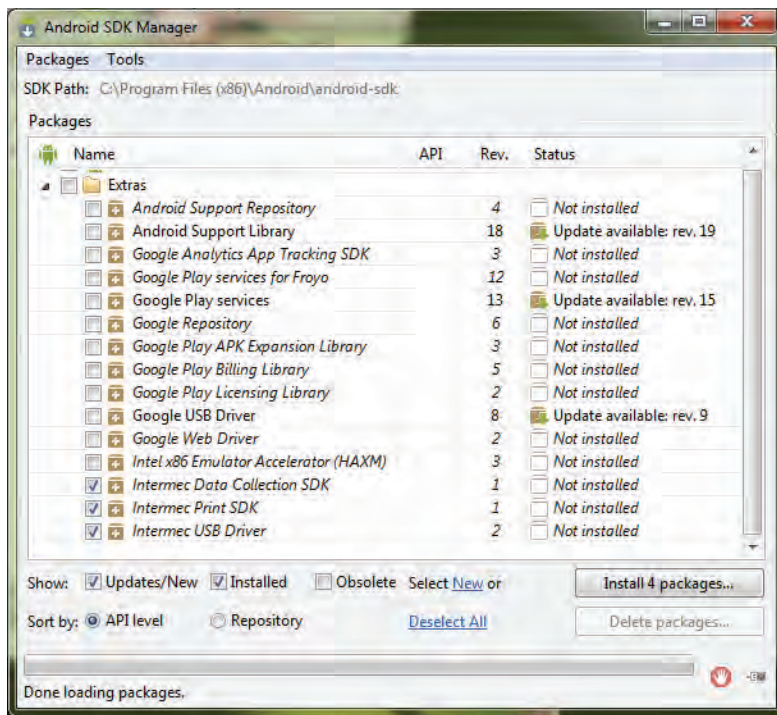

(Optional) If you plan to use the Intermec SDKs for Android, select **Intermec Data Collection SDK** and **Intermec Print SDK**.

- 8 Click **Install x packages**, where x is the number of packages you selected in the previous step.
- 9 In the **Choose Packages to Install** dialog box, click **Accept License** and then click **Install**. The packages are downloaded to your development PC.
- 10 In the Android SDK folder on your development PC, browse to `extras\intermec\usb_driver` and double-click **CN51_Windows_Drivers_1.xx.xx.xxx.exe**, where 1.xx.xx.xxx is the latest version number of the software. The Intermec USB driver is installed on your development PC.

- 11 From the command line, browse to the tools directory in the Android SDK directory and run this command:

```
android update adb
```

This command updates the Android Debug Bridge with the correct vendor ID.

How to Set Up the Mobile Computer for App Development

There are a few tasks you need to accomplish to set up the mobile computer for debugging and development work:

- Declare your app as debuggable in your Android Manifest.
- In the Settings app, you need to enable developer options and USB debugging on the computer.
- Set up your development PC to detect your device.

If you plan to use the Android Debug Bridge utility, you need a driver provided by Intermec. The driver is included with the Intermec SDK add-on.

For more information on setting up your computer for app development, go to: developer.android.com/tools/device.html.

Enable Developer Options

You can enable a variety of options intended to help develop applications quickly, including USB debugging, capturing bug reports, or showing CPU usage on the screen. For more information on the developer options, see developer.android.com.

- 1 Start the Settings app.
- 2 In the System section, tap **Developer options**.
- 3 Slide the Developer options switch on and enable the options you need.

How to Update the System Software

You can use these methods to update the system software on the computer:

- You can update individual computers, or multiple computers at the same time, using a device management system. For help, see the documentation for your device management system.
- You can update individual computers by copying the software update file to the internal storage (or an installed microSD card) on each computer. Then you can manually start the system update from the Settings app.

Update Computers Using a Device Management System

You can update multiple computers at the same time using a device management system. Several mobile device management systems support the CN51 running Android, including Honeywell Remote MasterMind, Intermec Skynax, and other third-party solutions. Contact these suppliers for information about obtaining their agent or client software for use with the CN51.

Update the System Software

You can update the system software by copying the update file to the computer internal storage or to an installed microSD card. Then you can manually start the system update from the Settings app.



Note: Do not unzip the software update file after you download the file.

- 1** Go to www.intermec.com and click **Support > Downloads**.
- 2** In the **Or Locate Product** section:
 - a** Select **Computers** in the Product Category list.
 - b** Select **Handheld Computers** in the Product Family list.
 - c** Select **CN51 Mobile Computer** in the Product list.
- 3** Click **Submit**. A list of downloads for the CN51 appears.

- 4** Locate the Android software update file and click the file name to download the file to your PC. You need to log in to download software.
- 5** Copy the software update file to the internal storage or to an installed microSD card on the CN51. Or, you can copy the file to a microSD card and then install the card in the computer.
- 6** Start the Settings app and tap **About phone > System updates**.
- 7** Tap the file name and then tap **OK**. The update begins and may take several minutes. When the update is complete, the computer restarts.

8

Troubleshoot and Maintain the Computer

Use this chapter to find answers to any problems you may encounter while using the computer. You will also find information on routine maintenance.

About Troubleshooting the Computer

These troubleshooting tables may help you fix some common problems you may experience with your computer. These tables group solutions for the Wi-Fi connection, 802.1x security, the scanner, and general operation of the computer.



Note: If you send the computer in for service, it is your responsibility to save the computer data and its configuration. Intermec is only responsible for ensuring that the hardware matches the original configuration when repairing or replacing the computer.

Wi-Fi Connection Problems

Use this section to find possible solutions to Wi-Fi connection problems.

Wi-Fi Connection Problems and Possible Solutions

Problem	Possible Solution
When you turn on the, mobile computer after it was suspended for 10 to 15 minutes or longer, the mobile computer can no longer send or receive messages over the network.	The host may have deactivated or lost the current terminal emulation session. In a TCP/IP direct connect network, turn off the “Keep Alive” message from host to maintain the TCP session while the computer is suspended.
The computer is connected to the network, and you move to a new site to collect data. Now, your mobile computer is not connected to the network.	Move closer to an access point or to a different location to reestablish communications until you reconnect with the network. Any data collected while out of range is transmitted over the network.
The mobile computer appears to be connected to the network, but you cannot establish a terminal emulation session with the host computer.	Move closer to an access point or to a different location to reestablish communications until you reconnect with the network. Any data collected while out of range is transmitted over the network.
The mobile computer appears to be connected to the network, but the host computer is not receiving any information from the mobile computer.	There may be a problem with the connection between the access point and the host computer. Check with network administrator or use your access point user’s manual.

802.1x Security Problems

Use this section to find possible solutions to 802.1x security problems.

802.1x Security Problems and Possible Solutions

Problem	Possible Solution
The mobile computer indicates that it is authenticated, but it does not communicate with the host.	Make sure the mobile computer IP address, host IP address, subnet mask, and default router are configured for the network.
The mobile computer does not appear to be authenticating and a network connection icon does not appear on the toolbar.	<ul style="list-style-type: none"> • The mobile computer may not be communicating with the access point. Make sure the mobile computer network name matches the access point network name (SSID). • The access point may not be communicating with the server. Ensure the access point is turned on, properly configured, and has 802.1x security enabled.
A network connection icon appears in the toolbar, but then disappears.	<ul style="list-style-type: none"> • The mobile computer may not be communicating with the intended access point. Make sure that the network name matches the access point network name. The default network name is “INTERMEC.” • The access point may not be communicating with the server. Ensure the access point is turned on, properly configured, and has 802.1x security enabled.
You are setting up multiple access points in a network with different SSIDs, and the connection fails.	When you change the SSID, the WEP key values are not saved. Configure the WEP key values and save your changes.

802.1x Security Problems and Possible Solutions (Continued)

Problem	Possible Solution
The mobile computer indicates it is not authenticated.	Make sure that: <ul style="list-style-type: none">• the User Name and Password parameters on the mobile computer match the user name and password on the authentication server. You may need to configure the password on both the mobile computer and the authentication server.• on your authentication server, the user and group are allowed and the group policy is allowed to log into the server. For help, see the documentation that shipped with your authentication server software.• the IP address and secret key for the access point match the IP address and secret key on the authentication server. You may need to configure the IP address and secret key on both your access point and authentication server.• the authentication server software is running on the server PC.
You clean boot the mobile computer and this message appears, “The server certificate has expired or your system date is incorrect.”	When you clean boot the computer, the date and time are not saved. Configure the date and time and save your changes.

Problems Reading Bar Codes

You can troubleshoot problems that prevent you from reading bar codes, such as the appropriate symbology not being enabled. Before you call Intermec Product Support, look for your problem in the next table, and try the possible solutions.

Problems Reading Bar Codes

Problem	Possible Solution
You cannot see the illumination beam or frame from the scanner when you press the Scan button and aim the scanner at a bar code label.	<ul style="list-style-type: none"> • You may be too far away from the bar code label. Try moving closer to the bar code label and scan it again. • You may be reading the bar code label “straight on.” Change the reading angle and try again.
When you release the Scan button or scan handle trigger, the Good Read LED does not turn off.	If you configure the computer to use continuous/edge triggering, the Good Read LED stays on. If you configure the computer for level triggering and the Good Read LED stays on, there may be a problem. Press the Scan button or pull the trigger again without scanning a bar code label. If the LED is still on, contact Intermec.

Problems Reading Bar Codes (Continued)

Problem	Possible Solution
The scanner cannot read the bar code.	<ul style="list-style-type: none">• Position the scanner beam so that it crosses the entire bar code label in one pass. Try to vary the scanning angle.• Check the quality of the bar code label. Scan a bar code label that you know scans properly. Compare the quality of the two bar code labels. You may need to replace the label that you cannot scan.• Make sure the bar code symbology is enabled and configured correctly. Start the Settings app and check the scanner settings to verify that decoding is enabled for the symbology you are using.• Make sure the computer application is expecting input from a bar code. You may need to type this information instead.
The scanner cannot read the bar code quickly, or the scanning beam seems to be faint or obscured.	The scanner window may be dirty. Clean the window with a solution of mild soap and water. Wipe dry. Do not allow abrasive material to touch the window.
You read a valid bar code label to enter data for your application. The data decoded by the scan module does not match the data encoded in the bar code label.	The computer may have decoded the bar code label in another symbology. Scan the bar code label again. Make sure you scan the entire label.
The input device attached to the computer does not work well or read bar code labels very quickly.	Set the Scanner Model command to the specific attached input device. Enable only the bar code symbologies being used.

Problems Using the Computer

You can troubleshoot general problems while using the computer. Before you call Intermec Product Support, look for your problem in the next table, and try the possible solutions.

Problems Using the Computer

Problem	Possible Solution
You press the Power button and nothing happens.	The battery may be completely drained. Replace or charge the battery and then restart the computer.
The computer screen appears to be locked up, and you cannot enter data.	<ul style="list-style-type: none"> • Press the Power button to suspend the computer, and then press Power again to turn the screen back on. • Reset the computer by selecting Reset from the power options screen. • Remove the battery and place it in a charge dock to make sure it is charged, and then replace it in the computer. • Remove the battery and replace it with a fully charged battery. • Press and hold the Power button for at least 15 seconds to completely turn off the computer, and then press Power again to turn the computer back on. <p>If none of these solutions is successful, you need to contact Intermec Product Support.</p>
You cannot type a character on the keypad, or you can only type uppercase or lowercase letters.	The orange or green modifier key may be locked. Unlock the key and try again.

Call Product Support

If you are having trouble using your computer, you can:

- use the troubleshooting tables in this manual to find your problem and possible solutions.
- visit the Intermec technical knowledge base, Knowledge Central at intermec.custhelp.com.

If you still need help, you can call Intermec Product Support at:

1-800-755-5505

Before you call Product Support, have this information ready:

- Configuration number (CN) and serial number (SN), printed on a label inside the battery compartment.
- Operating system version
- Power management settings
- Wireless security settings

Most information is available in the Settings app.

Locate the Build Version and Configuration String Using the Settings App

Before you call Product Support, you should have the Android build version and computer configuration string handy for reference. You can find this information in the Settings app.



Note: If the computer is locked up and you cannot start the Settings app, you can find the configuration string (beginning with the characters “CN51”) on the label on the access door inside the battery compartment.

- 1** Start the Settings app and tap **About phone**. The Android build version is located at the bottom of this list of information.
- 2** Tap **Status**. The computer configuration string is located at the bottom of this list.

Locate the Configuration String in the Battery Compartment

If the computer is locked up and you cannot start the Settings app, you can find the configuration string on the label on the access door inside the battery compartment.

- 1 Press and hold the Power button.
- 2 Tap **Battery swap**. The computer briefly shows a status message and the LEDs turn on. When the LEDs turn off, continue with the next step.

If the computer is in a dock, you must remove it from the dock before you can select **Battery swap**.

- 3 If necessary, disconnect the handstrap from the top of the computer.
- 4 Push forward on the battery release tab until the battery releases, and then lift the battery away from the computer.

The configuration string (beginning with the characters “CN51”) is located in the center of the label on the access door in the battery compartment.

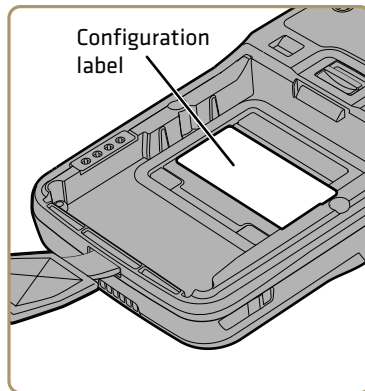

Reset the Computer

If the computer or an application seems to be locked up, you can try resetting the computer to restore the operating system. You may lose data in open apps when you reset the computer. All your settings are saved during a reset.

- 1 Press and hold the **Power** button. This screen appears:

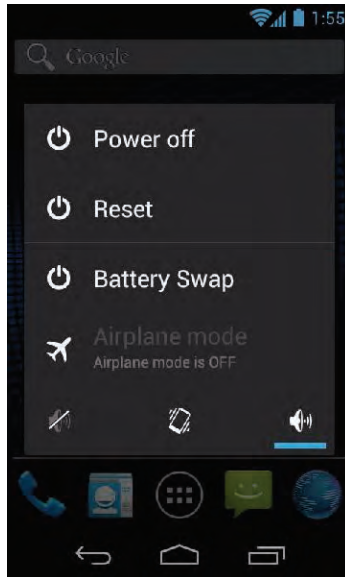

- 2 Tap **Reset**. The computer restarts.

Perform a Factory Data Reset



Caution: Performing a factory data reset completely erases all data, files, and downloaded apps from the computer memory. Back up your data and files before proceeding.

You can perform a factory data reset, which restores all default settings on the computer and erases all data, files, and downloaded apps.

- 1 Start the Settings app and tap **Backup & reset > Factory data reset**.

- 2 Tap **Reset phone**. A confirming message appears, reminding you that you cannot reverse this action.
- 3 Tap **Erase everything**. The computer restarts and all user data, files, and downloaded apps are erased.

Clean the Computer

To keep the computer in good working order, you may need to clean the scanner window, color camera window, and the touch screen. Clean the windows and the touch screen as often as needed for the environment in which you are using the computer. To clean the computer, use one of these recommended cleaning agents:

- Acetic acid, 10% in water
- Ethyl alcohol, 10% in water
- Mild soap solutions
- 5% to no more than 10% bleach or sodium hypochlorite with water



Caution: There are no user-serviceable parts inside the computer. Opening the computer will void the warranty and may cause damage to the internal components.



Note: Intermec recommends that you leave the battery installed when you clean the computer as described. Leaving the battery installed helps prevent fluids from entering the computer through the SIM card and microSD card connectors.

- 1 Press the **Power** button to suspend the computer.
- 2 Dip a clean cloth towel in the cleaning agent and wring out the excess.
- 3 Wipe off the scanner window, camera lens, and flash area. Do not allow any abrasive material to touch these surfaces.
- 4 Wipe dry.
- 5 Let the computer completely air dry before using again.

A

Specifications

Physical and Environmental Specifications

This section lists the physical and environmental specifications for the computer.

Physical Dimensions

Length:	16.5 cm (6.5 in)
Width (at widest part):	7.6 cm (3.0 in)
Depth (at grip):	3.2 cm (1.25 in)
Weight (with battery):	350 g (12.3 oz)

Tumble and Drop Specifications

Tumble Specification:	1,000 (0.5 m) tumbles per IEC 60068-2-32 specification.
Drop Specification:	Multiple 1.5 m (5 ft) drops to concrete at ambient temperature, multiple 1.2 m (4 ft) drops to concrete across the operating temperature range per MIL-STD 810G.

Power and Electrical Specifications

Operating battery:	Rechargeable lithium-ion battery
Backup battery:	Supercap supplies 1.5 minutes of bridge time while replacing the main battery.
Electrical rating:	== 4,65 V, 3 A

Temperature and Humidity Specifications

Operating temperature:	-10 °C to 50 °C (14 °F to 122 °F)
Storage temperature:	-20 °C to 60 °C (-4 °F to 140 °F). For maximum battery life store at 23 °C (73 °F) at 50% charge.
Charging temperature:	0 °C to 45 °C (32 °F to 113 °F). 20 °C to 25 °C (68 °F to 77 °F) will provide extended battery life.
Relative humidity (operating):	5% to 95% non-condensing
Environmental rating:	IP54, Category 1

Screen Specifications

- 480 x 800 pixels
- 10.16 cm (4.0 in) transmissive WVGA display
- LCD capable of both portrait and landscape operation
- LED backlight
- Ambient light sensor

Keypad Options

- Alphanumeric keypad
- Numeric keypad

Bar Code Symbolologies

- Australia Post*
- Aztec*
- BPO (British Post 4-state)*
- Canada Post
- Codabar
- Codablock A
- Codablock F
- Code 11
- Code 39
- Code 93
- Code 128/GS1-128
- DataMatrix*
- Dutch Post*
- EAN/UPC
- GS1 Composite*
- GS1 DataBar Expanded
- GS1 DataBar Limited
- GS1 DataBar Omni-Directional
- HanXin
- Infomail
- Intelligent Mail
- Interleaved 2 of 5
- JapanPost*
- Matrix 2 of 5
- Maxicode*
- Micro PDF417
- MSI
- PDF417*
- Planet*
- Plessey
- Postnet*
- QR Code*
- Standard 2 of 5
- SwedenPost
- Telepen
- TLC 39

EA31 Extended Reading Range

These typical reading distances are measured in an office environment (250 lux) for the EA31 standard model with Extended Reading Range activated. Extended Reading Range is enabled by default.

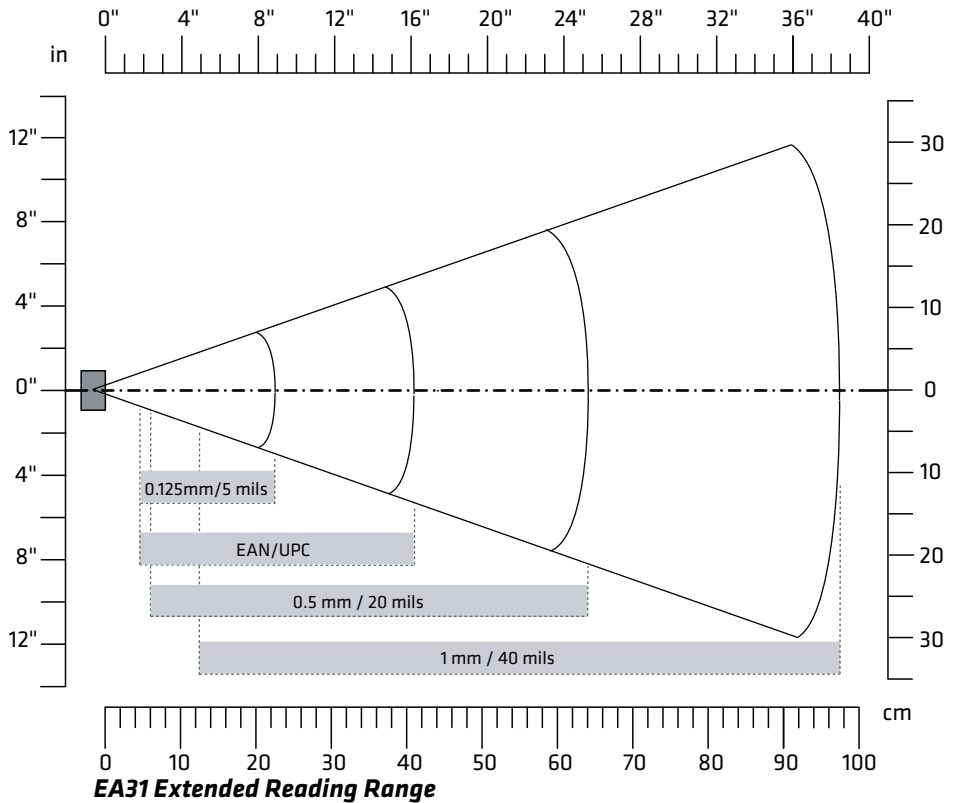

EA31 Extended Reading Range Activated

Symbology	Density	Minimum Distance	Maximum Distance
Code 39	0.125 mm/5 mils	4.50 cm/1.77 in	22.50 cm/8.86 in
	0.50 mm/20 mils	6.00 cm/2.36 in	64.00 cm/25.20 in
	1 mm/40 mils	12.50 cm/4.92 in	97.50 cm/38.39 in
EAN/UPC 100%	0.33 mm/13 mils	4.50 cm/1.77 in	41 cm/16.14 in

EA31 Minimum Reading Distances

Minimum reading distances are measured in the dark (0 lux).

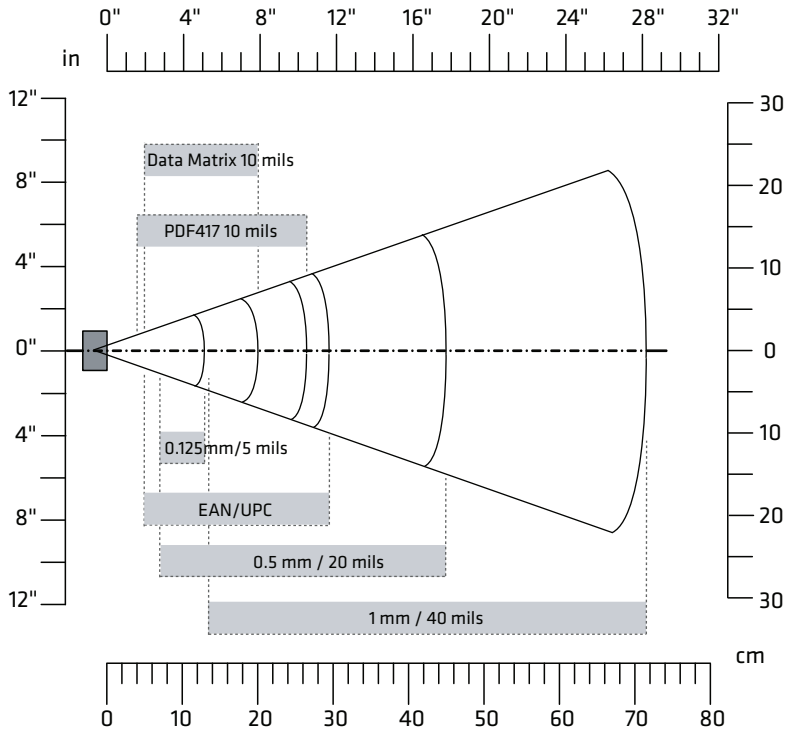

EA31 Minimum Reading Distances

EA31 Minimum Reading Distances

Symbology	Density	Minimum Distance	Maximum Distance
Code 39	0.10 mm/4 mils	8 cm/3.15 in	10 cm/3.94 in
	0.13 mm/5 mils	7 cm/2.76 in	13 cm/5.12 in
	0.20 mm/8 mils	4 cm/1.57 in	20 cm/7.87 in
	0.25 mm/10 mils	3.8 cm/1.5 in	24.5 cm/9.65 in
	0.50 mm/20 mils	7 cm/2.76 in	45 cm/17.72 in
	1 mm/40 mils	13.5 cm/5.31 in	71.5 cm/28.15 in
EAN/UPC 100%	0.33 mm/13 mils	5 cm/1.97 in	29.5 cm/11.61 in

EA31 Minimum Reading Distances (Continued)

Symbology	Density	Minimum Distance	Maximum Distance
DataMatrix	0.18 mm/7 mils	7 cm/2.76 in	14 cm/5.51 in
	0.25 mm/10 mils	5 cm/1.97 in	20 cm/7.87 in
	0.38 mm/15 mils	5.2 cm/2.05 in	29.5 cm/11.61 in
PDF417	0.17 mm/6.6 mils	5.8 cm/2.28 in	17.5 cm/6.89 in
	0.25 mm/10 mils	4 cm/1.57 in	26.5 cm/10.43 in
	0.38 mm/15 mils	4.9 cm/1.93 in	37 cm/14.57 in

EA31 Typical Reading Distances

Minimum reading distances are measured in the dark (0 lux).

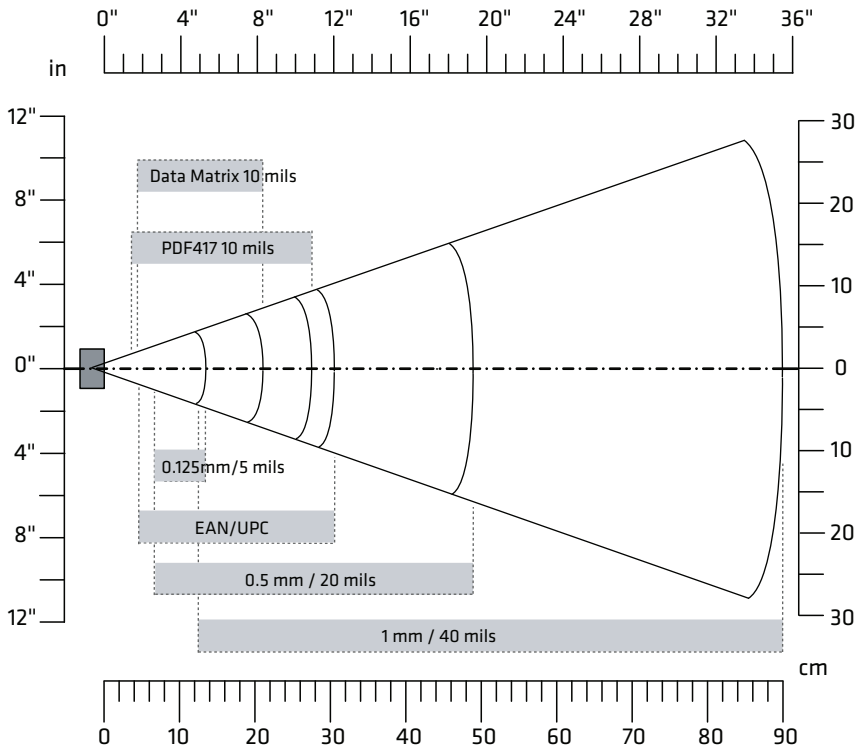

EA31 Typical Reading Distances

EA31 Typical Reading Distances

Symbology	Density	Minimum Distance	Maximum Distance
Code 39	0.10 mm/4 mils	7.5 cm/2.95 in	10.5 cm/4.13 in
	0.13 mm/5 mils	6.5 cm/2.56 in	13.5 cm/5.31 in
	0.20 mm/8 mils	4 cm/1.57 in	21 cm/8.27 in
	0.25 mm/10 mils	3.5 cm/1.38 in	25.5 cm/10 in
	0.50 mm/20 mils	6.5 cm/2.56 in	49 cm/19.29 in
	1 mm/40 mils	12.5 cm/4.92 in	90 cm/35.43 in
EAN/UPC 100%	0.33 mm/13 mils	4.5 cm/1.77 in	30.5 cm/12.01 in
DataMatrix	0.18 mm/7 mils	6.5 cm/2.56 in	15 cm/5.91 in
	0.25 mm/10 mils	4.5 cm/1.77 in	21 cm/8.27 in
	0.38 mm/15 mils	4.7 cm/1.85 in	31 cm/12.20 in
PDF417	0.17 mm/6.6 mils	5 cm/1.97 in	18.2 cm/7.17 in
	0.25 mm/10 mils	3.7 cm/1.46 in	27.5 cm/10.83 in
	0.38 mm/15 mils	4.5 cm/1.77 in	40 cm/15.75 in

EA30 Extended Reading Range

These typical reading distances are measured in an office environment (250 lux) for the EA30 standard model with Extended Reading Range activated. Extended Reading Range is enabled by default.

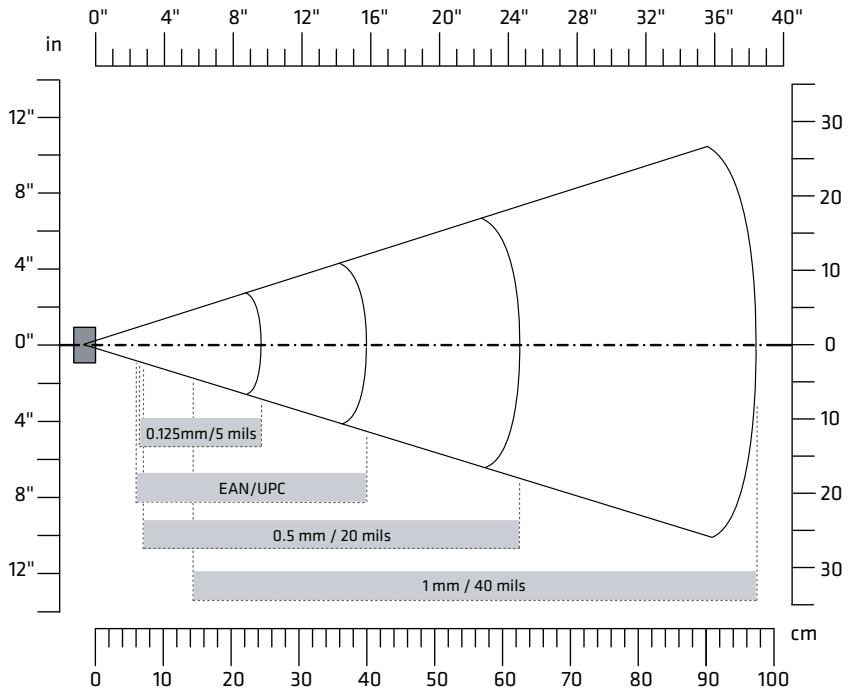

EA30 Extended Reading Range Activated

EA30 Extended Reading Range Activated

Symbology	Density	Minimum Distance	Maximum Distance
Code 39	0.125 mm/5 mils	64.50 cm/2.56 in	24.50 cm/9.65 in
	0.50 mm/20 mils	7.00 cm/2.76 in	62.50 cm/24.61 in
	1 mm/40 mils	14.50 cm/5.71 in	97.50 cm/38.39 in
EAN/UPC 100%	0.33 mm/13 mils	6 cm/2.36 in	40 cm/15.75 in

EA30 Minimum Reading Distances

Minimum reading distances are measured in the dark (0 lux).

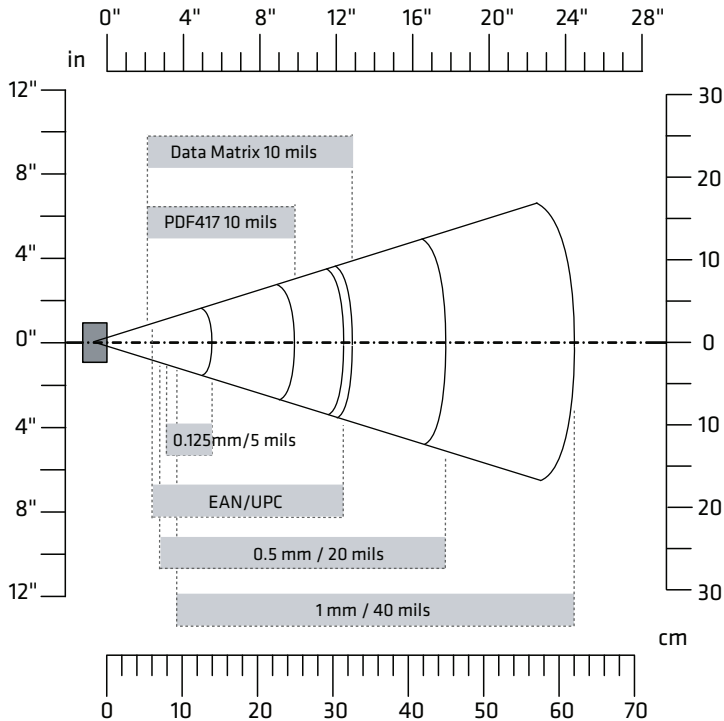

EA30 Minimum Reading Distances

EA30 Minimum Reading Distances

Symbology	Density	Minimum Distance	Maximum Distance
Code 39	0.10 mm/4 mils	9.5 cm/3.74 in	10.5 cm/4.13 in
	0.13 mm/5 mils	8 cm/3.15 in	14 cm/5.51 in
	0.50 mm/20 mils	7 cm/2.76 in	45 cm/17.72 in
	1 mm/40 mils	9.5 cm/3.74 in	62 cm/24.41 in
EAN/UPC 100%	0.33 mm/13 mils	6 cm/2.36 in	31.5 cm/12.4 in
DataMatrix	0.18 mm/7 mils	8 cm/3.15 in	15.5 cm/6.1 in
	0.25 mm/10 mils	6.5 cm/2.56 in	21.5 cm/8.46 in
	0.38 mm/15 mils	5.5 cm/2.17 in	31.5 cm/12.4 in

EA30 Minimum Reading Distances (Continued)

Symbology	Density	Minimum Distance	Maximum Distance
PDF417	0.25 mm/10 mils	5.5 cm/2.17 in	25 cm/9.84 in
	0.38 mm/15 mils	7 cm/2.76 in	34 cm/13.39 in

EA30 Typical Reading Distances

Minimum reading distances are measured in the dark (0 lux).

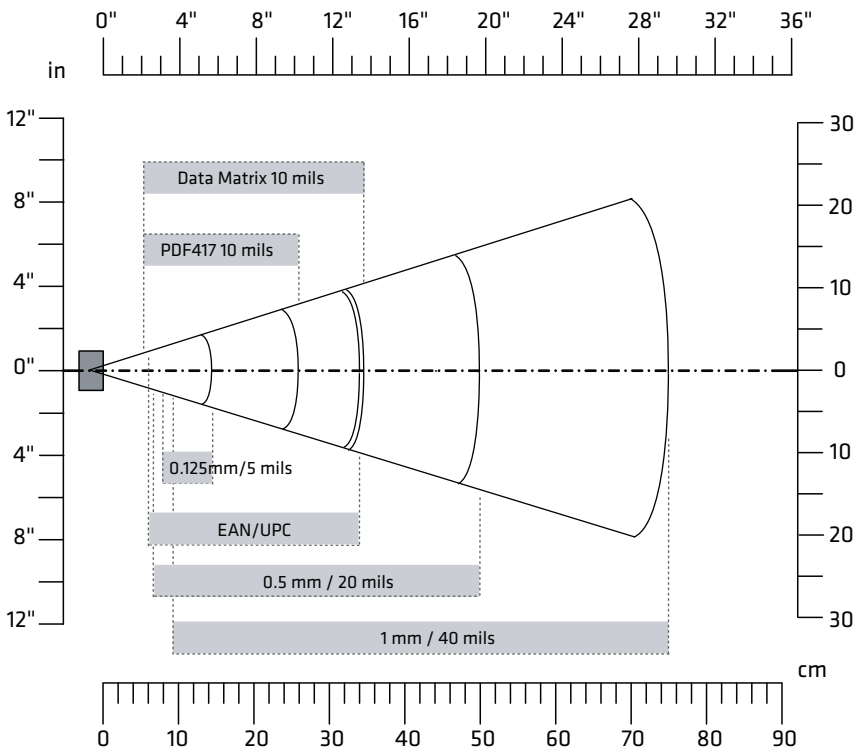

EA30 Typical Reading Distances

EA30 Typical Reading Distances

Symbology	Density	Minimum Distance	Maximum Distance
Code 39	0.10 mm/4 mils	9.5 cm/3.74 in	11.5 cm/4.53 in
	0.13 mm/5 mils	8 cm/3.15 in	14.5 cm/5.71 in
	0.50 mm/20 mils	6.5 cm/2.56 in	50 cm/19.69 in
	1 mm/40 mils	9.5 cm/3.74 in	75 cm/29.53 in
EAN/UPC 100%	0.33 mm/13 mils	6 cm/2.36 in	34 cm/13.39 in
DataMatrix	0.18 mm/7 mils	7.5 cm/2.95 in	16.5 cm/6.5 in
	0.25 mm/10 mils	6 cm/2.36 in	23 cm/9.06 in
	0.38 mm/15 mils	5.5 cm/2.17 in	34.5 cm/13.58 in
PDF417	0.25 mm/10 mils	5.5 cm/2.17 in	26 cm/10.24 in
	0.38 mm/15 mils	6.5 cm/2.56 in	37 cm/14.57 in

B

Default Settings

Wireless and Network Settings

This section lists all default wireless and network settings for the computer.

Wireless & Network Settings

Wireless & Network Settings	Default
Wi-Fi	Off
Bluetooth	Off
Ethernet	On
eth0	DHCP
Airplane mode	Disable
Portable Wi-Fi hotspot	Disable
Set up Wi-Fi hotspot	<ul style="list-style-type: none">• Network SSID: AndroidAP• Security: WPA2 PSK• Password: e61d78d7c877
Bluetooth tethering	Disable
Mobile network settings	<ul style="list-style-type: none">• Data enabled: Enable• Data Roaming: Disable• Use only 2G networks: Disable

Scanner Settings

This section lists all default settings for the internal scanner.

Scanner Settings

Setting	Default
Internal Scanner	On
Virtual Wedge	On
Security	<ul style="list-style-type: none">• Open URLs by Scanning: Enable• Web access: Disable

Internal Scanner - Symbologies

Symbologies	Default Value
Australian Post	Off
Aztec	Off
BPO	Off
CanadaPost	Off
Codabar	Off
Codablock A	Off
Codablock F	Off
Code 11	Off
Code 39	On
Code 93	Off
Code 128	On
DataMatrix	On
DutchPost	Off
EAN-8	On
EAN-13	On
GS1 Composite	Off
GS1 DataBar Expanded	Off
GS1 DataBar Limited	Off
GS1 DataBar Omni-Directional	Off
GS1-128	On
Han Xin	Off
Infomail	Off
Intelligent Mail	Off
Interleaved 2 of 5	Off
ISBT 128	Off
JapanPost	Off
Matrix 2 of 5	Off
Maxicode	Off
Micro PDF417	Off
MSI	Off
PDF417	On

Internal Scanner - Symbologies (Continued)

Symbologies	Default Value
Planet	Off
Plessey	Off
Postnet	Off
QR Code	Off
Standard 2 of 5	Off
SwedenPost	Off
Telepen	Off
TLC 39	Off
UPC-A	On
UPC-E	On
UPC-E1	Off

Internal Scanner - Symbology Options

Symbology Option	Default
Preamble	None
Postamble	None
Symbology identifier	Disable

Internal Scanner - Scanner Settings

Scanner Settings	Default
Hardware trigger	Enable
Trigger mode	Level
Aimer mode	Typical aimer
Turn off after good read	Enable/One-shot
Trigger timeout (s)	2
Aiming duration (ms)	500
Retrigger delay (ms)	0

Internal Scanner - Decode Security Settings

Decode Security Settings	Default
Consecutive data validation	0
Identical consecutive codes timeout	0
Different consecutive codes timeout	0
Center decoding	Disable
Center decoding tolerance	0

Device Settings

This section lists all default settings for computer-specific features such as sounds, battery management, or display settings.

Sound Settings

Sound Settings	Default
Volumes	<ul style="list-style-type: none"> • Music, video, games, & other media: About 80% of full volume • Ringtone & notifications: About 80% of full volume • Alarms: 100% of full volume
Phone ringtone	Flutey phone
Vibrate when ringing	Disable
Default notification	Pixie dust
Dial pad touch tones	Enable
Touch sounds	Enable
Screen lock sound	Enable
Vibrate on touch	Enable

Display Settings

Display Settings	Default
Brightness	Automatic brightness: Enabled

Display Settings (Continued)

Display Settings	Default
Wallpaper	Soundwave
Auto-rotate screen	Enable
Sleep	After 1 minute of inactivity
Font size	Normal

Personal Settings

This section lists default personal settings, including security features and language choices.

Personal Settings

Personal Settings	Default
Location services	<ul style="list-style-type: none">• Google’s location service: Disable• GPS satellites: Disable
Security	<ul style="list-style-type: none">• Screen lock: Slide• Make passwords visible: Enable• Unknown sources: Disable
Language & input	<ul style="list-style-type: none">• Spell checker: Enable• Default keyboard: English (US) - Android keyboard (AOSP)• Pico TTS settings: English (United States), Normal speech rate• Mouse/trackpad pointer speed: Medium

System Settings

This section lists default system settings, including accessibility and developer options.

Date & Time Settings

Date & Time Settings	Default
Automatic date & time	Enable
Automatic time zone	Enable
Use 24-hour format	Disable
Choose date format	Regional

Accessibility Settings

Accessibility Settings	Default
Large text	Disable
Power button ends call	Disable
Auto-rotate screen	Enable
Speak passwords	Disable
Text-to-speech output	<ul style="list-style-type: none"> • Language: English (United States) • Speech rate: Normal
Touch & hold delay	Short
Enhance web accessibility	Not allowed

Developer Options

Developer Options	Default
Developer options	Off
Desktop backup password	None specified
Stay awake	Disable
Protect SD card	Disable
USB debugging	Disable
Allow mock locations	Disable
Select debug app	None specified

Developer Options (Continued)

Developer Options	Default
Show touches	Disable
Pointer location	Disable
Show layout bounds	Disable
Show GPU view updates	Disable
Show surface updates	Disable
Window animation scale	Animation scale 1x
Transition animation scale	Animation scale 1x
Animator duration scale	Animation scale 1x
Disable HW overlays	Disable
Force GPU rendering	Disable
Strict mode enabled	Disable
Show CPU usage	Disable
Profile GPU rendering	Disable
Enable traces	None specified
Don't keep activities	Disable
Background process limit	Standard limit
Show all ANRs	Disable



Note: All developer options are turned off by default. The options listed are enabled only when developer options are turned on. For more information, go to developer.android.com.



6001 36th Avenue West
Everett, Washington 98203
U.S.A.

tel 425.348.2600

fax 425.355.9551

www.intermec.com

© 2014 Intermec by Honeywell
All rights reserved.

CN51 Mobile Computer User Manual



P/N 935-078-002