

**FUJIFILM**

DIGITAL CAMERA

**X-T20**

Owner's Manual

## Introduction

Thank you for your purchase of this product. Be sure that you have read this manual and understood its contents before using the camera. Keep the manual where it will be read by all who use the product.

### For the Latest Information

For the latest information on this product, including the latest versions of the manuals and sample color photographs, visit:

*<http://fujifilm-dsc.com/manuals/>*



The site can be accessed not only from your computer but also from smartphones and tablets.

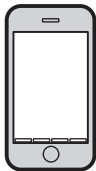



## Chapter Index

---

<b>Menu List</b>	iv
<b>1 Before You Begin</b>	1
<b>2 First Steps</b>	27
<b>3 Basic Photography and Playback</b>	47
<b>4 Movie Recording and Playback</b>	53
<b>5 Taking Photographs</b>	61
<b>6 The Shooting Menus</b>	113
<b>7 Playback and the Playback Menu</b>	173
<b>8 The Setup Menus</b>	199
<b>9 Shortcuts</b>	241
<b>10 Peripherals and Optional Accessories</b>	255
<b>11 Connections</b>	277
<b>12 Technical Notes</b>	289





# Menu List

Camera menu options are listed below.

## Shooting Menus

Adjust settings when shooting photos or movies.

 See page 113 for details.

<b>1/3</b>	<b>IMAGE QUALITY SETTING</b>		<b>AF/MF</b>	<b>AF/MF SETTING</b>	
1/3	IMAGE SIZE	115	1/2	FOCUS AREA	133
	IMAGE QUALITY	116		AF MODE	134
	RAW RECORDING	117		AF-C CUSTOM SETTINGS	135
	FILM SIMULATION	118		AF POINT DISPLAY  	136
	GRAIN EFFECT	120		NUMBER OF THE FOCUS POINTS	136
	DYNAMIC RANGE	121		PRE-AF	137
	WHITE BALANCE	122		AF-ILLUMINATOR	137
	HIGHLIGHT TONE	126		FACE/EYE DETECTION SETTING	138
	SHADOW TONE	126		AF+MF	140
	COLOR	127		MF ASSIST	141
2/3	SHARPNESS	127	FOCUS CHECK	141	
	NOISE REDUCTION	128	INTERLOCK SPOT AE & FOCUS AREA	142	
	LONG EXPOSURE NR	128	INSTANT AF SETTING	142	
	LENS MODULATION OPTIMIZER	129	DEPTH-OF-FIELD SCALE	143	
	COLOR SPACE	129	RELEASE/FOCUS PRIORITY	143	
3/3	PIXEL MAPPING	130	TOUCH SCREEN MODE	144	
	SELECT CUSTOM SETTING	131			
	EDIT/SAVE CUSTOM SETTING	131			

	<b>SHOOTING SETTING</b>		<b>FLASH SETTING</b>	
	SCENE POSITION	147	FLASH FUNCTION SETTING	164
	DRIVE SETTING	149	RED EYE REMOVAL	165
	SELF-TIMER	151	TTL-LOCK MODE	166
	INTERVAL TIMER	152	LED LIGHT SETTING	167
1/2	SHOOTING	152	MASTER SETTING	167
	PHOTOMETRY	154	CH SETTING	168
	SHUTTER TYPE	155	<b>MOVIE SETTING</b>	
	IS MODE	156	MOVIE MODE	169
	ISO	157	MOVIE AF MODE	170
	MOUNT ADAPTOR SETTING	160	HDMI OUTPUT INFO DISPLAY	170
2/2	WIRELESS COMMUNICATION	163	4K MOVIE OUTPUT	171
			HDMI REC CONTROL	171
			MIC LEVEL ADJUSTMENT	172
			MIC/REMOTE RELEASE	172

## The Playback Menu

Adjust playback settings.







See page 180 for details.

	<b>PLAY BACK MENU</b>			<b>PLAY BACK MENU</b>	
	RAW CONVERSION	180		SLIDE SHOW	191
	ERASE	183		PHOTOBOOK ASSIST	192
	CROP	186		PC AUTO SAVE	194
	RESIZE	187	2/2	PRINT ORDER (DPOF)	195
1/2	PROTECT	188		instax PRINTER PRINT	197
	IMAGE ROTATE	189		DISP ASPECT	198
	RED EYE REMOVAL	190			
	WIRELESS COMMUNICATION	191			

## Setup Menus

Adjust basic camera settings.

 See page 199 for details.

 USER SETTING		 SCREEN SETTING	
<b>FORMAT</b>	201	<b>EVF BRIGHTNESS</b>	212
<b>DATE/TIME</b>	202	<b>EVF COLOR</b>	213
<b>TIME DIFFERENCE</b>	203	<b>LCD BRIGHTNESS</b>	213
<b>言語/LANG.</b>	204	<b>LCD COLOR</b>	214
<b>MY MENU SETTING</b>	204	<b>1½ IMAGE DISP.</b>	214
<b>SENSOR CLEANING</b>	206	<b>EVF AUTOROTATE DISPLAYS</b>	215
<b>SOUND &amp; FLASH</b>	206	<b>PREVIEW EXP./WB IN MANUAL MODE</b>	215
<b>RESET</b>	207	<b>PREVIEW PIC. EFFECT</b>	216
<b> SOUND SETTING</b>		<b>FRAMING GUIDELINE</b>	217
<b>AF BEEP VOL.</b>	208	<b>2½ AUTOROTATE PB</b>	218
<b>SELF-TIMER BEEP VOL.</b>	209	<b>FOCUS SCALE UNITS</b>	218
<b>OPERATION VOL.</b>	209	<b>DISP. CUSTOM SETTING</b>	219
<b>SHUTTER VOLUME</b>	210		
<b>SHUTTER SOUND</b>	210		
<b>PLAYBACK VOLUME</b>	211		





# Table of Contents

<b>Introduction</b> .....	<b>ii</b>
For the Latest Information.....	ii
<b>Menu List</b> .....	<b>iv</b>
Shooting Menus.....	iv
The Playback Menu .....	v
Setup Menus.....	vi
<b>Supplied Accessories</b> .....	<b>xix</b>
<b>About This Manual</b> .....	<b>xx</b>
Symbols and Conventions .....	xx
Terminology .....	xx









## **1 Before You Begin** **1**

<b>Parts of the Camera</b> .....	<b>2</b>
The Serial Number Plate .....	4
The Selector.....	4
The Shutter Speed Dial.....	5
The Exposure Compensation Dial.....	5
The Drive Dial .....	6
The Auto Mode Selector Lever.....	7
The Command Dials .....	8
The Indicator Lamp .....	10
The LCD Monitor.....	11
Focusing the Viewfinder.....	11





<b>Camera Displays</b> .....	<b>12</b>
Electronic Viewfinder/LCD Monitor .....	12
Choosing a Display Mode .....	14
Adjusting Display Brightness.....	15
The Viewfinder Display .....	15
The DISP/BACK Button .....	16
Customizing the Standard Display .....	17
<b>Using the Menus</b> .....	<b>20</b>
<b>Touch Screen Mode</b> .....	<b>22</b>
Shooting Touch Controls .....	22
Playback Touch Controls .....	24
<b>2 First Steps</b> .....	<b>27</b>
Attaching the Strap .....	28
Attaching a Lens.....	30
Charging the Battery .....	32
Inserting Batteries and Memory Cards .....	36
Compatible Memory Cards .....	40
Turning the Camera On and Off .....	42
Checking the Battery Level.....	43
Basic Setup .....	44
Choosing a Different Language.....	46
Changing the Time and Date.....	46

<b>3 Basic Photography and Playback</b>	<b>47</b>
Taking Photographs (Mode P).....	48
▶ Viewing Pictures.....	51
🗑 Deleting Pictures.....	52
<b>4 Movie Recording and Playback</b>	<b>53</b>
🎥 Recording Movies.....	54
Adjusting Movie Settings.....	57
▶ Viewing Movies.....	58
<b>5 Taking Photographs</b>	<b>61</b>
Choosing a Shooting Mode.....	62
Mode P: Program AE.....	62
Mode S: Shutter-Priority AE.....	64
Mode A: Aperture-Priority AE.....	69
Mode M: Manual Exposure.....	72
Auto Mode.....	74
Autofocus.....	77
Focus Mode.....	78
Autofocus Options (AF Mode).....	80
Focus-Point Selection.....	82
Manual Focus.....	87
Checking Focus.....	89
📷 Exposure Compensation.....	91
C (Custom).....	91
Focus/Exposure Lock.....	92
The AF-L and AE-L Buttons.....	93

<b>BKT Bracketing</b> .....	<b>94</b>
 AE BKT .....	95
 ISO BKT .....	95
 FILM SIMULATION BKT .....	95
 WHITE BALANCE BKT .....	96
 DYNAMIC RANGE BKT .....	96
 Continuous Shooting (Burst Mode) .....	<b>97</b>
<b>ADV. Advanced Filters</b> .....	<b>99</b>
Advanced Filter Options.....	100
 Multiple Exposures .....	<b>101</b>
 Panoramas .....	<b>103</b>
<b>Flash Photography</b> .....	<b>107</b>
Flash Settings .....	109

## **6 The Shooting Menus** **113**

 <b>IMAGE QUALITY SETTING</b> .....	<b>114</b>
IMAGE SIZE.....	115
IMAGE QUALITY .....	116
RAW RECORDING .....	117
FILM SIMULATION.....	118
GRAIN EFFECT .....	120
DYNAMIC RANGE.....	121
WHITE BALANCE.....	122
HIGHLIGHT TONE .....	126
SHADOW TONE .....	126
COLOR.....	127
SHARPNESS.....	127

NOISE REDUCTION.....	128
LONG EXPOSURE NR.....	128
LENS MODULATION OPTIMIZER.....	129
COLOR SPACE.....	129
PIXEL MAPPING.....	130
SELECT CUSTOM SETTING.....	131
EDIT/SAVE CUSTOM SETTING.....	131
<b>AF/MF</b> <b>AF/MF SETTING .....</b>	<b>133</b>
FOCUS AREA.....	133
AF MODE.....	134
AF-C CUSTOM SETTINGS.....	135
AF POINT DISPLAY   .....	136
NUMBER OF THE FOCUS POINTS.....	136
PRE-AF.....	137
AF ILLUMINATOR.....	137
FACE/EYE DETECTION SETTING.....	138
AF+MF.....	140
MF ASSIST.....	141
FOCUS CHECK.....	141
INTERLOCK SPOT AE & FOCUS AREA.....	142
INSTANT AF SETTING.....	142
DEPTH-OF-FIELD SCALE.....	143
RELEASE/FOCUS PRIORITY.....	143
TOUCH SCREEN MODE.....	144
<b>SHOOTING SETTING.....</b>	<b>147</b>
SCENE POSITION.....	147
DRIVE SETTING.....	149

SELF-TIMER.....	151
INTERVAL TIMER SHOOTING.....	152
PHOTOMETRY.....	154
SHUTTER TYPE .....	155
IS MODE.....	156
ISO .....	157
MOUNT ADAPTOR SETTING.....	160
WIRELESS COMMUNICATION .....	163
<b>⚡ FLASH SETTING.....</b>	<b>164</b>
FLASH FUNCTION SETTING .....	164
RED EYE REMOVAL .....	165
TTL-LOCK MODE.....	166
LED LIGHT SETTING .....	167
MASTER SETTING .....	167
CH SETTING.....	168
<b>🎬 MOVIE SETTING .....</b>	<b>169</b>
MOVIE MODE.....	169
MOVIE AF MODE .....	170
HDMI OUTPUT INFO DISPLAY.....	170
4K MOVIE OUTPUT .....	171
HDMI REC CONTROL.....	171
MIC LEVEL ADJUSTMENT .....	172
MIC/REMOTE RELEASE.....	172

## **7 Playback and the Playback Menu 173**

The Playback Display .....	174
The DISP/BACK Button .....	176

Viewing Pictures.....	178
Playback Zoom.....	179
Multi-Frame Playback.....	179
<b>▣ The Playback Menu .....</b>	<b>180</b>
RAW CONVERSION .....	180
ERASE.....	183
CROP .....	186
RESIZE.....	187
PROTECT.....	188
IMAGE ROTATE .....	189
RED EYE REMOVAL .....	190
WIRELESS COMMUNICATION .....	191
SLIDE SHOW.....	191
PHOTOBOOK ASSIST .....	192
PC AUTO SAVE.....	194
PRINT ORDER (DPOF).....	195
instax PRINTER PRINT.....	197
DISP ASPECT .....	198

## **8 The Setup Menus 199**

<b>▣ USER SETTING .....</b>	<b>200</b>
FORMAT .....	201
DATE/TIME.....	202
TIME DIFFERENCE .....	203
<b>言語/LANG.</b> .....	204
MY MENU SETTING.....	204
SENSOR CLEANING .....	206

SOUND & FLASH.....	206
RESET .....	207
<b>🔧 SOUND SETTING .....</b>	<b>208</b>
AF BEEP VOL.....	208
SELF-TIMER BEEP VOL.....	209
OPERATION VOL.....	209
SHUTTER VOLUME.....	210
SHUTTER SOUND.....	210
PLAYBACK VOLUME .....	211
<b>🔧 SCREEN SETTING.....</b>	<b>212</b>
EVF BRIGHTNESS.....	212
EVF COLOR.....	213
LCD BRIGHTNESS.....	213
LCD COLOR.....	214
IMAGE DISP.....	214
EVF AUTOROTATE DISPLAYS.....	215
PREVIEW EXP/WB IN MANUAL MODE.....	215
PREVIEW PIC. EFFECT.....	216
FRAMING GUIDELINE.....	217
AUTOROTATE PB.....	218
FOCUS SCALE UNITS.....	218
DISP. CUSTOM SETTING.....	219
<b>🔧 BUTTON/DIAL SETTING .....</b>	<b>221</b>
EDIT/SAVE QUICK MENU.....	222
Fn/AE-L/AF-L BUTTON SETTING.....	224
SELECTOR BUTTON SETTING.....	226
COMMAND DIAL SETTING .....	226

SHUTTER AF.....	227
SHUTTER AE.....	227
SHOOT WITHOUT LENS.....	228
FOCUS RING.....	228
AE/AF-LOCK MODE.....	229
APERTURE SETTING.....	229
TOUCH SCREEN SETTING.....	230
<b>☑ POWER MANAGEMENT.....</b>	<b>231</b>
AUTO POWER OFF.....	231
PERFORMANCE.....	232
<b>☑ SAVE DATA SETTING.....</b>	<b>233</b>
FRAME NO.....	234
SAVE ORG IMAGE.....	235
EDIT FILE NAME.....	235
COPYRIGHT INFO.....	236
<b>☑ CONNECTION SETTING.....</b>	<b>237</b>
WIRELESS SETTINGS.....	237
PC AUTO SAVE SETTING.....	238
GEOTAGGING SET-UP.....	238
instax PRINTER CONNECTION SETTING.....	239

## **9 Shortcuts 241**

Shortcut Options.....	242
The Q (Quick Menu) Button.....	243
The Quick Menu Display.....	243
Viewing and Changing Settings.....	245
Editing the Quick Menu.....	246



The Fn (Function) Buttons .....	248
Assigning Roles to the Function Buttons.....	250
<b>MY MY MENU</b> .....	252
MY MENU SETTING .....	252
<b>10 Peripherals and Optional Accessories</b> .....	<b>255</b>
External Flash Units .....	256
Flash Settings .....	257
SYNC TERMINAL.....	259
BUILT-IN FLASH.....	260
SHOE MOUNT FLASH .....	262
MASTER(OPTICAL) .....	266
Lenses.....	271
Lens Parts.....	271
Removing Lens Caps .....	272
Attaching Lens Hoods .....	272
Lenses with Aperture Rings.....	273
Lenses with No Aperture Rings.....	274
Lenses with O.I.S. Switches.....	274
Manual Focus Lenses.....	275
Lens Care.....	276
<b>11 Connections</b> .....	<b>277</b>
HDMI Output .....	278
Connecting to HDMI Devices .....	278
Shooting.....	279
Playback.....	279

<b>Wireless Transfer</b> .....	<b>280</b>
Wireless Connections: Smartphones.....	280
Wireless Connections: Computers .....	281
<b>Connecting to Computers via USB</b> .....	<b>282</b>
Windows .....	282
Mac OS X/macOS.....	283
Connecting the Camera.....	283
<b>instax SHARE Printers</b> .....	<b>286</b>
Establishing a Connection .....	286
Printing Pictures.....	287

## **12 Technical Notes** **289**

Accessories from FUJIFILM .....	290
For Your Safety .....	294
Product Care .....	307
Cleaning the Image Sensor .....	308
Firmware Updates.....	309
Checking the Firmware Version .....	309
Troubleshooting.....	310
Warning Messages and Displays .....	319
Memory Card Capacity .....	323
Specifications .....	324

## Supplied Accessories

---

The following are included with the camera:

- NP-W126S rechargeable battery
- BC-W126 battery charger
- Body cap
- Metal strap clips (× 2)
- Clip attaching tool
- Protective covers (× 2)
- Shoulder strap
- *Owner's Manual* (this manual)



If you purchased a lens kit, check that a lens is included.

## About This Manual

This manual contains instructions for your FUJIFILM X-T20 digital camera. Be sure you have read and understood its contents before proceeding.

### Symbols and Conventions

The following symbols are used in this manual:



Information that should be read to prevent damage to the product.



Additional information that may be helpful when using the product.



Pages on which related information may be found.

Menus and other text in the displays are shown in **bold**. Illustrations are for explanatory purposes only; drawings may be simplified, while photographs are not necessarily taken with the model of camera described in this manual.

### Terminology

The optional SD, SDHC, and SDXC memory cards the camera uses to store pictures are referred to as “memory cards”. The electronic viewfinder may be referred to as the “EVF” and the LCD monitor as the “LCD”.

# Before You Begin



# Parts of the Camera

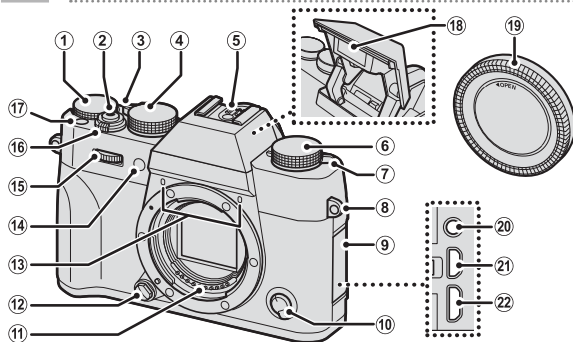

- |                                                |                                                                                       |
|------------------------------------------------|---------------------------------------------------------------------------------------|
| ① Exposure compensation dial<br>..... 5, 91    | ⑭ AF-assist illuminator..... 137<br>Self-timer lamp ..... 151                         |
| ② Shutter button ..... 50                      | ⑮ Front command dial..... 8, 226                                                      |
| ③ Auto mode selector lever..... 7              | ⑯ <b>ON/OFF</b> switch ..... 42                                                       |
| ④ Shutter speed dial..... 5, 64, 72            | ⑰ <b>Fn1</b> button ..... 248                                                         |
| ⑤ Hot shoe ..... 256                           | ⑱ Flash..... 107                                                                      |
| ⑥ Drive dial ..... 6                           | ⑲ Body cap..... 30                                                                    |
| ⑦ $\frac{1}{2}$ (flash pop-up) lever ..... 107 | ⑳ Microphone/remote release<br>connector ( $\varnothing$ 2.5 mm)<br>..... 55, 68, 172 |
| ⑧ Strap eyelet ..... 28                        | ㉑ HDMI Micro connector (Type D)<br>..... 278                                          |
| ⑨ Connector cover                              | ㉒ Micro USB (Micro-B)<br>USB 2.0 connector ..... 35, 68, 283                          |
| ⑩ Focus mode selector ..... 78                 |                                                                                       |
| ⑪ Lens signal contacts                         |                                                                                       |
| ⑫ Lens release button ..... 31                 |                                                                                       |
| ⑬ Microphone..... 172                          |                                                                                       |

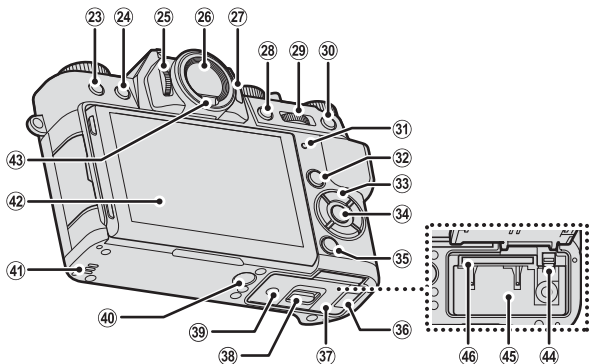

- |    |                                                 |    |                                                            |
|----|-------------------------------------------------|----|------------------------------------------------------------|
| 23 | (delete) button..... 52                         | 35 | <b>DISP</b> (display)/ <b>BACK</b> button<br>..... 16, 176 |
| 24 | (playback) button..... 51                       | 36 | Cable channel cover for<br>DC coupler ..... 290            |
| 25 | Diopter adjustment control..... 11              | 37 | Battery-chamber cover..... 36                              |
| 26 | Electronic viewfinder (EVF)<br>..... 12, 14, 15 | 38 | Battery-chamber cover latch..... 36                        |
| 27 | <b>VIEW MODE</b> button..... 14                 | 39 | Serial number plate..... 4                                 |
| 28 | <b>AE-L</b> (exposure lock) button..... 93      | 40 | Tripod mount                                               |
| 29 | Rear command dial<br>..... 9, 178, 226          | 41 | Speaker ..... 58                                           |
| 30 | <b>AF-L</b> (focus lock) button..... 93         | 42 | LCD monitor..... 11, 12, 14, 15                            |
| 31 | Indicator lamp..... 10, 35                      | 43 | Eye sensor..... 14                                         |
| 32 | <b>Q</b> (quick menu) button..... 243           | 44 | Battery latch..... 39                                      |
| 33 | Selector buttons..... 4, 226                    | 45 | Battery chamber..... 36                                    |
| 34 | <b>MENU/OK</b> button..... 4, 20                | 46 | Memory card slot..... 36                                   |

## The Serial Number Plate



Do not remove the serial number plate, which provides the FCC ID, KC mark, serial number, and other important information.

## The Selector

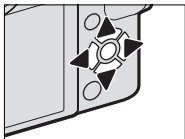
Press the selector up (▲), right (▶), down (▼), or left (◀) to highlight items. The up, down, left, and right buttons also double as function buttons **Fn2** through **Fn5** (📖 248).



### Control Lock

To prevent accidental operation of the selector and **Q** button during shooting, press **MENU/OK** until  is displayed. The controls can be unlocked by pressing **MENU/OK** until  is no longer displayed.



## The Shutter Speed Dial

The shutter speed dial is used to choose the shutter speed.

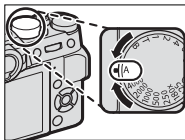

## The Exposure Compensation Dial

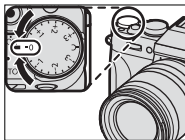

Rotate the dial to choose an exposure compensation amount.

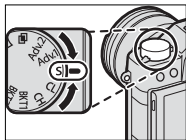

## The Drive Dial

Rotate the dial to choose from the following the drive modes.





Mode		Mode	
 Movie	54	<b>S</b> Single frame	48
<b>BKT1</b> <b>BKT2</b> Bracketing	94	<b>Adv.1</b> <b>Adv.2</b> Advanced filter	99
<b>CH</b> High-speed burst	97	 Multiple exposure	101
<b>CL</b> Low-speed burst		 Panorama	103

## The Auto Mode Selector Lever

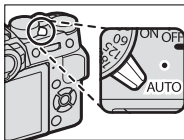
Switch between auto and manual modes.

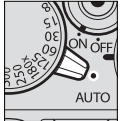
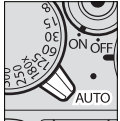

Position	Mode
	<p>Select from <b>P</b> (program AE), <b>S</b> (shutter-priority AE), <b>A</b> (aperture-priority AE), and <b>M</b> (manual) modes (📖 62, 64, 69, 72). Adjust shutter speed and aperture using program shift (mode <b>P</b>) or set shutter speed and/or aperture manually (modes <b>S</b>, <b>A</b>, and <b>M</b>).</p>
	<p>Auto mode. The camera adjusts settings automatically according to the option selected by rotating the front command dial. Choose from modes suited to specific subject types (📖 74), or select <b>SR+ ADVANCED SR AUTO</b> to let the camera automatically match the mode to the subject (📖 74). Scene selection is not available in drive modes <b>Adv.1</b>, <b>Adv.2</b>, 📷, and 📺.</p>

 Restrictions may apply to camera settings depending on the mode and shooting conditions.

## The Command Dials

Rotate or press the command dials to:

### Front command dial

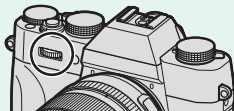

#### Rotate



- Select menu tabs or page through menus.
- Adjust aperture.
- Select a scene when shooting in auto mode.
- Adjust exposure compensation when **C** is selected with exposure compensation dial.
- View other pictures during playback.

#### Press



Switch back and forth between aperture and exposure compensation when **C** is selected with the exposure compensation dial.

## Rear command dial

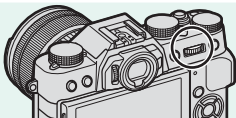

### Rotate



- Highlight menu items.
- Choose the desired combination of shutter speed and aperture (program shift).
- Choose a shutter speed.
- Adjust settings in the quick menu.
- Choose the size of the focus frame.
- Zoom in or out in full-frame or multi-frame playback.

### Press



- Zoom in on the active focus point during playback.
- Perform the function assigned to the **DIAL** function button.
- Press and hold to choose the manual focus mode focus display.

## The Indicator Lamp

When the viewfinder is not in use, camera status is shown by the indicator lamp.

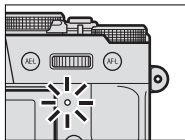

Indicator lamp	Camera status
Glow green	Focus locked.
Blinks green	Focus or slow shutter speed warning. Pictures can be taken.
Blinks green and orange	Recording pictures. Additional pictures can be taken.
Glow orange	Recording pictures. No additional pictures can be taken at this time.
Blinks orange	Flash charging; flash will not fire when picture is taken.
Blinks red	Lens or memory error.





Warnings may also appear in the display.

## The LCD Monitor

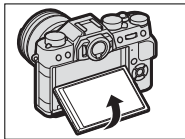
The LCD monitor can be tilted for easier viewing, but be careful not to touch the wires or trap fingers or other objects behind the monitor. Touching the wires could cause camera malfunction.



 The LCD monitor also functions as a touch screen ( 22, 144).

## Focusing the Viewfinder

The camera is equipped with diopter adjustment in the range  $-4$  to  $+2 \text{ m}^{-1}$  to accommodate individual differences in vision. Rotate the diopter adjustment control until the viewfinder display is in sharp focus.

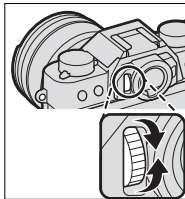

## Camera Displays

This section lists the indicators that may be displayed during shooting.

**!** For illustrative purposes, displays are shown with all indicators lit.

### Electronic Viewfinder/LCD Monitor

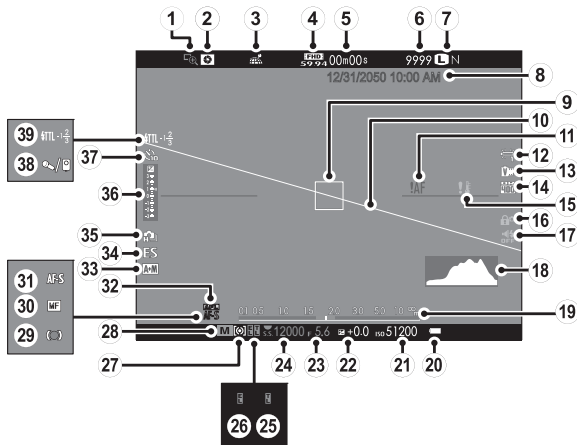



- |                                           |                                        |
|-------------------------------------------|----------------------------------------|
| ① Focus check ..... 89, 141               | ②① Sensitivity ..... 157               |
| ② Depth-of-field preview ..... 70, 89     | ②② Exposure compensation ..... 91      |
| ③ Location data download status ..... 238 | ②③ Aperture ..... 63, 69, 72           |
| ④ Movie mode ..... 54, 169                | ②④ Shutter speed ..... 63, 64, 72      |
| ⑤ Time remaining ..... 54                 | ②⑤ TTL lock ..... 166, 225, 251        |
| ⑥ Number of available frames* ... 323     | ②⑥ AE lock ..... 92, 93, 227           |
| ⑦ Image quality and size ..... 115, 116   | ②⑦ Metering ..... 154                  |
| ⑧ Date and time ..... 44, 202, 203        | ②⑧ Shooting mode ..... 62              |
| ⑨ Focus frame ..... 82, 92                | ②⑨ Focus indicator ..... 79            |
| ⑩ Virtual horizon ..... 18                | ③⑩ Manual focus indicator ..... 87     |
| ⑪ Focus warning ..... 50, 319             | ③① Focus mode ..... 78                 |
| ⑫ White balance ..... 122                 | ③② AF lock ..... 92, 93, 227           |
| ⑬ Film simulation ..... 118               | ③③ AF+MF indicator ..... 140           |
| ⑭ Dynamic range ..... 121                 | ③④ Shutter type ..... 155              |
| ⑮ Temperature warning ..... 322           | ③⑤ Continuous mode ..... 97            |
| ⑯ Control lock ..... 4                    | ③⑥ Exposure indicator ..... 72, 91     |
| ⑰ Sound and flash indicator ..... 206     | ③⑦ Self-timer indicator ..... 151      |
| ⑱ Histogram ..... 19                      | ③⑧ Microphone/remote release ..... 172 |
| ⑲ Distance indicator ..... 89             | ③⑨ Flash (TTL) mode ..... 109          |
| ⑳ Battery level ..... 43                  | Flash compensation ..... 109           |

\* Shows "9999" if there is space for over 9999 frames.

### Control Lock

Pressing a locked control displays a  icon.



## Choosing a Display Mode

Press the **VIEW MODE** button to cycle through the following display modes:

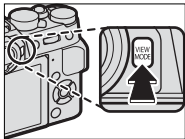

- **EYE SENSOR** **EYE SENSOR**: Putting your eye to the viewfinder turns the viewfinder on and the LCD monitor off; taking your eye away turns the viewfinder off and LCD monitor on.
- **EVF ONLY**: Viewfinder on, LCD monitor off.
- **LCD ONLY**: LCD monitor on, viewfinder off.
- **EVF ONLY** + **EYE SENSOR**: Putting your eye to the viewfinder turns the viewfinder on; taking it away turns the viewfinder off. The LCD monitor remains off.

### The Eye Sensor

The eye sensor may respond to objects other than your eye or to light shining directly on the sensor.

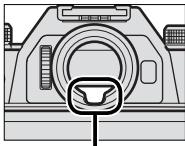

*Eye sensor*

## Adjusting Display Brightness

The brightness and hue of the viewfinder and LCD monitor can be adjusted using the items in the  **SCREEN SETTING** menu. Choose **EVF BRIGHTNESS** or **EVF COLOR** to adjust viewfinder brightness or hue, **LCD BRIGHTNESS** or **LCD COLOR** to do the same for the LCD monitor.

## The Viewfinder Display

When **ON** is selected for  **SCREEN SETTING > EVF AUTOROTATE DISPLAYS**, the indicators in the viewfinder automatically rotate to match camera orientation.

 The display in the LCD monitor is unaffected.

## The DISP/BACK Button

The **DISP/BACK** button controls the display of indicators in the viewfinder and LCD monitor.

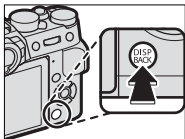

### Viewfinder

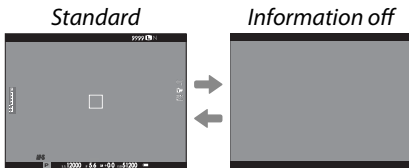

### LCD Monitor

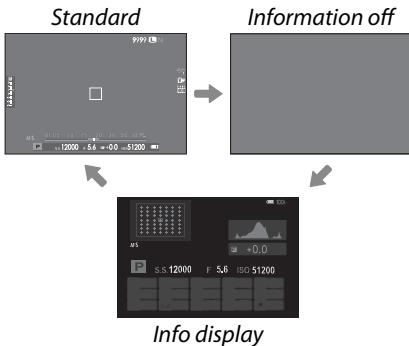

## Customizing the Standard Display

To choose the items shown in the standard display:

### 1 Display standard indicators.

Use the **DISP/BACK** button to display standard indicators.

### 2 Select **DISP. CUSTOM SETTING**.

Select **SCREEN SETTING > DISP. CUSTOM SETTING** in the setup menu.

### 3 Choose items.

Highlight items and press **MENU/OK** to select or deselect.

- FRAMING GUIDELINE
- ELECTRONIC LEVEL
- FOCUS FRAME
- AF DISTANCE INDICATOR
- MF DISTANCE INDICATOR
- HISTOGRAM
- SHOOTING MODE
- APERTURE/S-SPEED/ISO
- INFORMATION
- BACKGROUND
- Expo. Comp. (Digit)
- Expo. Comp. (Scale)
- FOCUS MODE
- PHOTOMETRY
- SHUTTER TYPE
- FLASH
- CONTINUOUS MODE
- DUAL IS MODE
- TOUCH SCREEN MODE
- WHITE BALANCE
- FILM SIMULATION
- DYNAMIC RANGE
- FRAMES REMAINING
- IMAGE SIZE/QUALITY
- MOVIE MODE & REC. TIME
- BATTERY LEVEL
- FRAMING OUTLINE

#### 4 Save changes.

Press **DISP/BACK** to save changes.

#### 5 Exit the menus.

Press **DISP/BACK** as needed to exit the menus and return to the shooting display.

#### Virtual Horizon

Selecting **ELECTRONIC LEVEL** displays a virtual horizon. The camera is level when the two lines overlap. Note that the virtual horizon may not be displayed if the camera lens is pointed up or down.

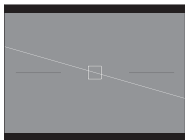

#### Framing Outline

Enable **FRAMING OUTLINE** to make the borders of the frame easier to see against dark backgrounds.

## Histograms

Histograms show the distribution of tones in the image. Brightness is shown by the horizontal axis, the number of pixels by the vertical axis.

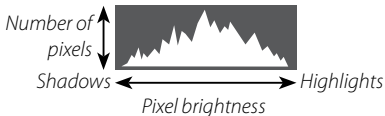

- **Optimal exposure:** Pixels are distributed in an even curve throughout the tone range.
- **Overexposed:** Pixels are clustered on the right side of the graph.
- **Underexposed:** Pixels are clustered on the left side of the graph.



## Using the Menu

To display the menu, press **MENU/OK**.

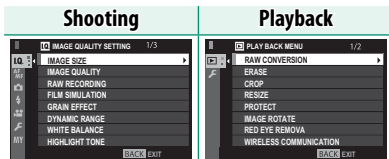
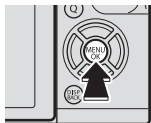





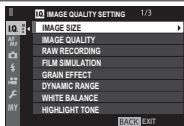

To navigate the menus:

- 1 Press **MENU/OK** to display the menu.
- 2 Press the selector left to highlight the tab for the current menu.



*Tab*



- 3 Press the selector up or down to highlight the tab (IQ, AF ME, , , , MY,  or ) containing the desired item.
  - 4 Press the selector right to place the cursor in the menu.
-  Use the front command dial to select menu tabs or page through menus and the rear command dial to highlight menu items.



## Touch Screen Mode

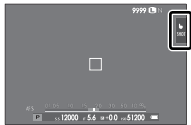

Use touch controls for shooting or playback.

### Shooting Touch Controls



Touch controls can be used for such operations as choosing the focus area and taking photographs. The operation performed can be selected by tapping the touchscreen mode indicator in the display to cycle through the following options:



Mode	Description
<b>TOUCH SHOOTING</b> 	Tap your subject in the display to focus and release the shutter.
<b>AF</b> 	Tap to select a focus point. In focus mode <b>S</b> (AF-S), focus will lock, while in focus mode <b>C</b> (AF-C), the camera will continually adjust focus in response to changes in the distance to the subject.

Mode	Description
<b>AREA</b> 	Tap to select a point for focus or zoom. The focus frame will move to the selected point.
<b>OFF</b> 	Touch controls off. The display does not respond when tapped.



Touch control settings can be adjusted using  **AF/MF SETTING** > **TOUCH SCREEN MODE** ( 144). To disable touch controls and hide the touch screen mode indicator, select **OFF** for  **BUTTON/DIAL SETTING** > **TOUCH SCREEN SETTING**.

## Playback Touch Controls

When **ON** is selected for **▶ BUTTON/DIAL SETTING > TOUCH SCREEN SETTING**, touch controls can be used for the following playback operations:

- **Swipe:** Swipe a finger across the display to view other images.



- **Pinch-out:** Place two fingers on the display and spread them apart to zoom in.



- **Pinch-in:** Place two fingers on the display and slide them together to zoom out.



Pictures can be zoomed out until the entire image is visible but no further.

- **Double-tap:** Tap the display twice to zoom in on the selected area.



- **Drag:** View other areas of the image during playback zoom.





# First Steps

# 2

## Attaching the Strap

Attach the strap clips to the camera and then attach the strap.

### 1 Open a strap clip.

Use the clip attaching tool to open a strap clip, making sure that the tool and clip are in the orientations shown.

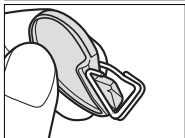
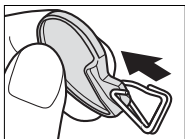

### 2 Place the strap clip on an eyelet.

Hook the strap eyelet in the clip opening. Remove the tool, using the other hand to keep the clip in place.

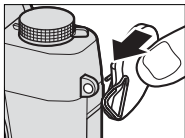

Keep the tool in a safe place, as you will need it to open the strap clips when removing the strap.

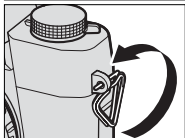



- 3 Pass the clip through the eyelet.**  
Rotate the clip fully through the eyelet until it clicks closed.



- 4 Attach a protective cover.**  
Place a protective cover over the eyelet as shown, with the black side of the cover toward the camera.

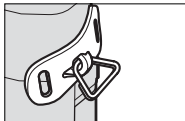

- 5 Fasten the strap.**  
Insert the strap through a protective cover and strap clip and fasten as shown.

**!** To avoid dropping the camera, be sure the strap is correctly secured.

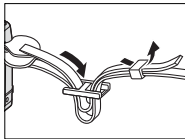
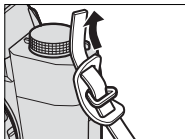

Repeat Steps 1–5 for the second eyelet.

## Attaching a Lens

The camera can be used with lenses for the FUJIFILM X-mount.

Remove the body cap from the camera and the rear cap from the lens. Place the lens on mount, keeping the marks on the lens and camera aligned, and then rotate the lens until it clicks into place.

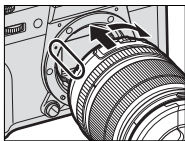

**!** When attaching lenses, ensure that dust or other foreign matter does not enter the camera and be careful not to touch the camera's internal parts. Do not press the lens release button while attaching the lens and be sure the latch has securely clicked into place.

### Removing Lenses

To remove the lens, turn the camera off, then press the lens release button and rotate the lens as shown.

**!** To prevent dust accumulating on the lens or inside the camera, replace the lens caps and camera body cap when the lens is not attached.

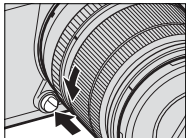

### Lenses and Other Optional Accessories

The camera can be used with lenses and accessories for the FUJIFILM X-mount.

**!** Before attaching or removing (exchanging) lenses, attach the lens caps and check that the lenses are free of dust and other foreign matter. Do not change lenses in direct sunlight or under another bright light source, as light focused into the interior of the camera could cause it to malfunction.

## Charging the Battery

The battery is not charged at shipment. Before use, charge the battery in the supplied battery charger.

**!** An NP-W126S rechargeable battery is supplied with the camera. Charging takes about 150 minutes.

### 1 Place the battery in the charger.

Place the battery in the supplied battery charger as shown.

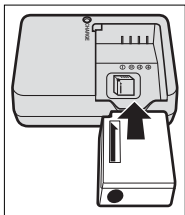

### 2 Plug the charger in.

Plug the charger into an indoor power outlet. The charging indicator will light.

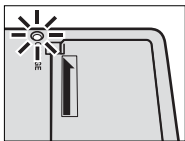

### 3 Charge the battery.

Remove the battery when charging is complete.

## The Charging Indicator

The charging indicator shows battery charge status as follows:

 <b>Charging indicator</b>	<b>Battery status</b>	<b>Action</b>
Off	Battery not inserted.	Insert the battery.
	Battery fully charged.	Remove the battery.
On	Battery charging.	—
Blinks	Battery fault.	Unplug the charger and remove the battery.



The supplied AC cord is for use exclusively with the supplied battery charger. Do not use the supplied charger with other cords or the supplied cord with other devices.

Do not affix labels or other objects to the battery. Failure to observe this precaution could make it impossible to remove the battery from the camera.

Do not short the battery terminals. The battery could overheat.

Read the cautions in “The Battery and Power Supply”.

Use only battery chargers designated for use with the battery. Failure to observe this precaution could result in product malfunction.

Do not remove the labels from the battery or attempt to split or peel the outer casing.

The battery gradually loses its charge when not in use. Charge the battery one or two days before use. If the battery fails to hold a charge, it has reached the end of its charging life and must be replaced.

Unplug the charger when it is not in use.

Remove dirt from the battery terminals with a clean, dry cloth. Failure to observe this precaution could prevent the battery from charging.

Note that charging times increase at low temperatures.

### Charging via Computer

The battery also charges if the camera is connected to a computer. Turn the camera off, insert the battery, and connect a USB cable as shown, making sure the connectors are fully inserted. The charging time of about 300 minutes is not affected by the type of cable used.

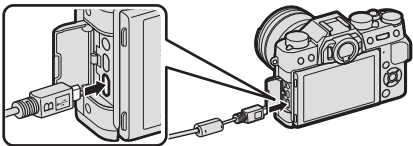

Charging status is shown by the indicator lamp.

Indicator lamp	Battery status
On	Battery charging
Off	Charging complete
Blinks	Battery fault

Connect the camera directly to the computer; do not use a USB hub or keyboard. Charging stops if the computer enters sleep mode; to resume charging, activate the computer and disconnect and reconnect the USB cable. Charging may not be supported depending on the model of computer, computer settings, and the computer's current state.

## Inserting Batteries and Memory Cards

After charging the battery, insert the battery and memory card as described below.

### 1 Open the battery-chamber cover.

Slide the battery-chamber latch as shown and open the battery-chamber cover.

**!** Do not open the battery-chamber cover when the camera is on. Failure to observe this precaution could damage image files or memory cards.

Do not use excessive force when handling the battery-chamber cover.

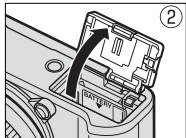
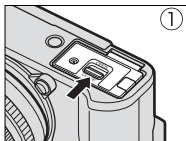



## 2 Insert the battery.

Using the battery to keep the battery latch pressed to one side, insert the battery contacts first in the direction shown by the arrow. Confirm that the battery is securely latched.

 Insert the battery in the orientation shown. *Do not use force or attempt to insert the battery upside down or backwards.* The battery will slide in easily in the correct orientation.

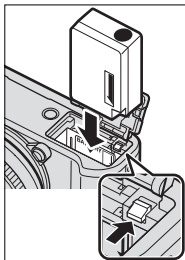

## 3 Insert the memory card.

Holding the card in the orientation shown, slide it in until it clicks into place at the back of the slot.

 Be sure card is in the correct orientation; do not insert at an angle or use force.

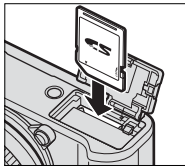

## 4 Close the battery-chamber cover. Close and latch the cover.

 If the cover does not close, check that the battery is in the correct orientation. Do not attempt to force the cover shut.

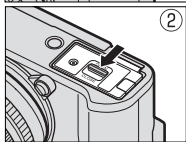
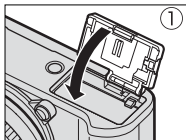

## Removing the Battery

Before removing the battery, *turn the camera off* and open the battery-chamber cover.

To remove the battery, press the battery latch to the side, and slide the battery out of the camera as shown.

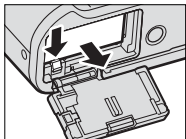

 The battery may become hot when used in high-temperature environments. Observe caution when removing the battery.

## Removing Memory Cards

Before removing memory cards, *turn the camera off* and open the battery-chamber cover.

Press and release the card to eject it part way (to prevent the card falling from the slot, press the center of the card and release it slowly, without removing your finger from the card). The card can then be removed by hand.

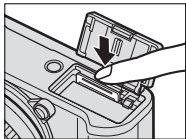

## Compatible Memory Cards

FUJIFILM and SanDisk SD, SDHC, and SDXC memory cards have been approved for use in the camera; UHS-I is supported. Cards with a UHS speed class of 3 or better are recommended for movies. A complete list of approved memory cards is available at [http://www.fujifilm.com/support/digital\\_cameras/compatibility/](http://www.fujifilm.com/support/digital_cameras/compatibility/). Operation is not guaranteed with other cards. The camera can not be used with xD-Picture Cards or MultiMediaCard (MMC) devices.

**!** *Do not turn the camera off or remove the memory card while the memory card is being formatted or data are being recorded to or deleted from the card. Failure to observe this precaution could damage the card.*

Memory cards can be locked, making it impossible to format the card or to record or delete images. Before inserting a memory card, slide the write-protect switch to the unlocked position.





Format memory cards before first use, and be sure to reformat all memory cards after using them in a computer or other device.

Memory cards are small and can be swallowed; keep out of reach of children. If a child swallows a memory card, seek medical assistance immediately.

miniSD or microSD adapters that are larger or smaller than memory cards may not eject normally; if the card does not eject, take the camera to an authorized service representative. Do not forcibly remove the card.

Do not affix labels or other objects to memory cards. Peeling labels can cause camera malfunction.

Movie recording may be interrupted with some types of memory card.

Formatting a memory card in the camera creates a folder in which pictures are stored. Do not rename or delete this folder or use a computer or other device to edit, delete, or rename image files. Always use the camera to delete pictures; before editing or renaming files, copy them to a computer and edit or rename the copies, not the originals. Renaming the files on the camera can cause problems during playback.

## Turning the Camera On and Off

Use the **ON/OFF** switch to turn the camera on and off.

Rotate the switch to **ON** to turn the camera on, or to **OFF** to turn the camera off.

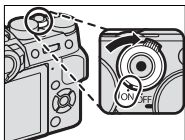

**!** Fingerprints and other marks on the lens or viewfinder can affect pictures or the view through the viewfinder. Keep the lens and viewfinder clean.







**▶** Press the **▶** button to start playback. Press the shutter button halfway to return to shooting mode.

The camera will turn off automatically if no operations are performed for the length of time selected for **▶ POWER MANAGEMENT > AUTO POWER OFF**. To reactivate the camera after it has turned off automatically, press the shutter button halfway or turn the **ON/OFF** switch to **OFF** and then back to **ON**.

## Checking the Battery Level

After turning the camera on, check the battery level in the display.

Battery level is shown as follows:

Indicator	Description
	Battery partially discharged.
	Battery about 80% full.
	Battery about 60% full.
	Battery about 40% full.
	Battery about 20% full.
 (red)	Low battery. Charge as soon as possible.
 (blinks red)	Battery exhausted. Turn camera off and recharge battery.



## Basic Setup

A language-selection dialog is displayed the first time the camera is turned on.

### 1 Turn the camera on.

A language-selection dialog will be displayed.

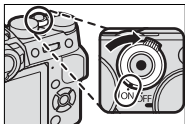

### 2 Choose a language.

Highlight a language and press **MENU/OK**.

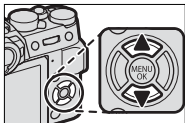

### 3 Set the date and time.

Press the selector left or right to highlight the year, month, day, hour, or minute and press up or down to change. To change the order in which the year, month, and day are displayed, highlight the date format and press the selector up or down. Press **MENU/OK** to exit to shooting mode when settings are complete.

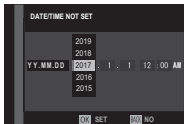





If the battery is removed for an extended period, the camera clock will be reset and the language-selection dialog will be displayed when the camera is turned on.

### **Skipping the Current Step**

Press **DISP/BACK** to skip the current step. Any steps you skip will be displayed the next time the camera is turned on.

## Choosing a Different Language

To change the language:

---

- 1 Display language options.**  
Select **USER SETTING > 言語/LANG..**
- 2 Choose a language.**  
Highlight the desired option and press **MENU/OK**.

## Changing the Time and Date

To set the camera clock:

---

- 1 Display DATE/TIME options.**  
Select **USER SETTING > DATE/TIME**.
- 2 Set the clock.**  
Press the selector left or right to highlight the year, month, day, hour, or minute and press up or down to change. Press **MENU/OK** to set the clock.

# Basic Photography and Playback

# 3

## Taking Photographs (Mode P)

This section describes how to take pictures using program AE (mode P). See pages 62–73 for information on S, A, and M modes.

### 1 Adjust settings for program AE.

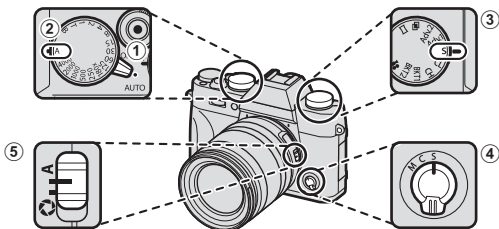

- ① **Auto mode selector lever** ( 7): Select ●.
- ② **Shutter speed** ( 62): Select A (auto).
- ③ **Drive mode** ( 6): Select S (single frame).
- ④ **Focus mode** ( 78): Select S (single AF).
- ⑤ **Aperture** ( 62): Select A (auto).

**2 Check the shooting mode.**

Confirm that **P** appears in the display.

**3 Ready the camera.**

Hold the camera steady with both hands and brace your elbows against your sides. Shaking or unsteady hands can blur your shots.

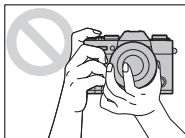

To prevent pictures that are out of focus or too dark (underexposed), keep your fingers and other objects away from the lens and AF-assist illuminator.

**4 Frame the picture.****Lenses with Zoom Rings**

Use the zoom ring to frame the picture in the display. Rotate the ring left to zoom out, right to zoom in.

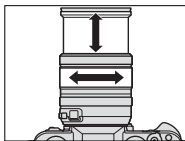

**5 Focus.**

Press the shutter button half-way to focus.



If the subject is poorly lit, the AF-assist illuminator may light.

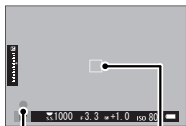

*Focus indicator*

*Focus frame*

**If the camera is able to focus**, it will beep twice and focus area and focus indicator will glow green. Focus and exposure will lock while the shutter button is pressed halfway.

**If the camera is unable to focus**, the focus frame will turn red, **!AF** will be displayed, and the focus indicator will blink white.

**6 Shoot.**

Smoothly press the shutter button the rest of the way down to take the picture.



## Viewing Pictures

Pictures can be viewed in the viewfinder or LCD monitor.

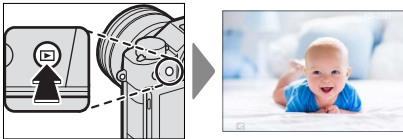
To view pictures full frame, press .



Additional pictures can be viewed by pressing the selector left or right or rotating the front command dial. Press the selector or rotate the dial right to view pictures in the order recorded, left to view pictures in reverse order. Keep the selector pressed to scroll rapidly to the desired frame.

 Pictures taken using other cameras are marked with a  ("gift image") icon to warn that they may not display correctly and that playback zoom may not be available.



## Deleting Pictures

Use the  button to delete pictures.



Deleted pictures can not be recovered. Copy important pictures to a computer or other storage device before proceeding.

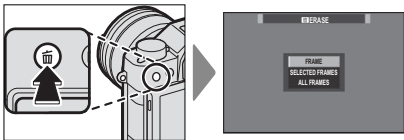

- 1 With a picture displayed full frame, press the  button and select **FRAME**.



- 2 Press the selector left or right to scroll through pictures and press **MENU/OK** to delete (a confirmation dialog is not displayed). Repeat to delete additional pictures.



Protected pictures can not be deleted. Remove protection from any pictures you wish to delete ( 188).

Pictures can also be deleted from the menus using the  **PLAY BACK MENU** > **ERASE** option ( 183).



# Movie Recording and Playback

# 4



## Recording Movies

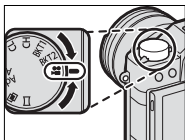

This section describes how to film movies in auto mode.

- 1 Rotate the drive dial to .

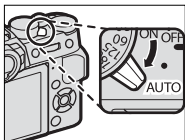

- 2 Rotate the auto mode selector lever to **AUTO** to shoot movies in **SR+ ADVANCED SR AUTO** mode.



Rotate the lever to  to shoot movies in mode **P**. Movies shot with  selected for **MOVIE MODE** will also be recorded in mode **P**.

- 3 Press the shutter button to start recording. A recording indicator () and the time remaining are displayed while recording is in progress.



- 4 Press the button again to end recording. Recording ends automatically when the maximum length is reached or the memory card is full.

#### Using an External Microphone

Sound can be recorded with external microphones that connect using jacks 2.5 mm in diameter; microphones that require bus power can not be used. See the microphone manual for details.

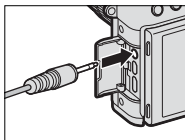



Sound is recorded via the built-in microphone or an optional external microphone. Do not cover the microphone during recording. Note that the microphone may pick up lens noise and other sounds made by the camera during recording.

Vertical or horizontal streaks may appear in movies containing very bright subjects. This is normal and does not indicate a malfunction.



The indicator lamp lights while recording is in progress. During recording, you can change exposure compensation by up to  $\pm 2$  EV and adjust zoom using the zoom ring on the lens (if available).

If the lens is equipped with an aperture mode switch, select the aperture mode before beginning recording. If an option other than **A** is selected, shutter speed and aperture can be adjusted while recording is in progress.

Recording may be unavailable at some settings, while in other cases settings may not apply during recording.

## Adjusting Movie Settings

Frame size and rate can be selected using **MOVIE SETTING > MOVIE MODE**, while the card used to store movies can be selected using **SAVE DATA SETTING > MOVIE FILE DESTINATION**. Focus mode is selected using the focus mode selector; for continuous focus adjustment, select **C**, or choose **S** and enable Intelligent Face Detection. Intelligent Face Detection is not available in focus mode **M**.

### Depth of Field

Choose low f-numbers to soften background details.





## Viewing Movies

View movies on the camera.

In full-frame playback, movies are identified by a  icon.



The following operations can be performed while a movie is displayed:

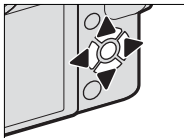

Selector	Playback in progress (  )	Playback paused (  )
	End playback	
	Pause playback	Start/resume playback
	Adjust speed	Single frame rewind/advance



Progress is shown in the display during playback.



 Do not cover the speaker during playback.

 Press **MENU/OK** to pause playback and display volume controls. Press the selector up or down to adjust the volume; press **MENU/OK** again to resume playback. Volume can also be adjusted using  **SOUND SETTING** > **PLAYBACK VOLUME**.

### Playback Speed

Press the selector left or right to adjust playback speed during playback. Speed is shown by the number of arrows (▶ or ◀).

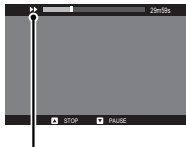

Arrows

# ***MEMO***

---

---

---

---

---

---

---

---

---

---

---

---

---

---

---

---

---

---

---

---

---

---

---

---

---

---

---

---

---



# Taking Photographs

# 5

## Choosing a Shooting Mode

For control over shutter speed and aperture (P, S, A, and M modes), rotate the auto mode selector lever to ●. Rotate the lever to **AUTO** to choose from modes suited to specific subject types, or select **SR+ ADVANCED SR AUTO** to let the camera automatically match the mode to the subject.

### Mode P: Program AE

Let the camera choose shutter speed and aperture for optimal exposure. Other values that produce the same exposure can be selected with program shift.

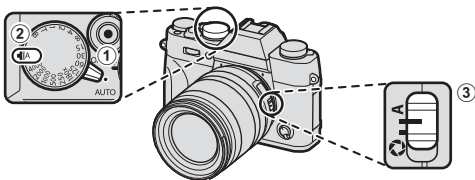

Adjust settings as follows:

- 1 **Auto mode selector lever:** ●
- 2 **Shutter speed:** A (auto)
- 3 **Aperture:** A (auto)

Confirm that **P** appears in the display.



**!** If the subject is outside the metering range of the camera, the shutter speed and aperture displays will show " \_ \_ \_ ".

### Program Shift

If desired, you can rotate the rear command dial to select other combinations of shutter speed and aperture without altering exposure (program shift).



Shutter speed

Aperture

**!** Program shift is not available during movie recording or if the flash supports TTL auto or an auto option is selected for **IMAGE QUALITY SETTING > DYNAMIC RANGE**.

**📷** The new values for shutter speed and aperture are shown in yellow.

To cancel program shift, turn the camera off.

## Mode S: Shutter-Priority AE

Choose a shutter speed and let the camera adjust aperture for optimal exposure.

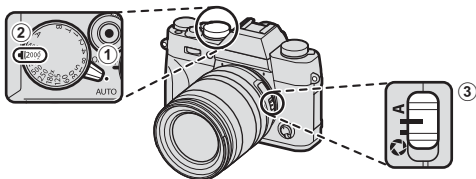

Adjust settings as follows:

- 1 **Auto mode selector lever:** ●
- 2 **Shutter speed:** Choose a shutter speed
- 3 **Aperture:** A (auto)

Confirm that **S** appears in the display.



**!** If the correct exposure can not be achieved at the selected shutter speed, aperture will be displayed in red. If the subject is outside the metering range of the camera, the aperture display will show “-- --”.

 At settings other than **180X**, shutter speed can also be adjusted in increments of  $\frac{1}{3}$  EV by rotating the rear command dial. Shutter speed can be adjusted even while the shutter button is pressed halfway.

### Sensitivity and Depth of Field

If you choose a fast shutter speed when the subject is poorly lit, the camera autoexposure program will select a wider aperture. This will produce the correct exposure but may also reduce depth of field so that less of the area behind and in front of your subject appears to be in focus. To stop aperture down and increase depth of field, select a higher sensitivity.



## Time (T)

Rotate the shutter speed dial to **T** (time) to choose slow shutter speeds for long time-exposures. Use of a tripod is recommended to prevent the camera moving during the exposure.

- 1 Rotate the shutter speed dial to **T**.

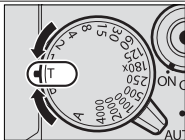

- 2 Rotate the rear command dial to choose a shutter speed.

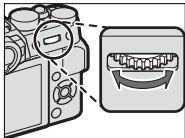

- 3 Press the shutter button all the way down to take a picture at the selected shutter speed. A count-down timer will be displayed while the exposure is in progress.

 To reduce “noise” (mottling) in long time-exposures, select **ON** for **IMAGE QUALITY SETTING > LONG EXPOSURE NR.** Note that this may increase the time needed to record images after shooting.

## Bulb (B)

Select a shutter speed of **B** (bulb) for long time-exposures in which you open and close the shutter manually. Use of a tripod is recommended to prevent the camera moving during the exposure.

- 1 Rotate the shutter speed dial to **B**.

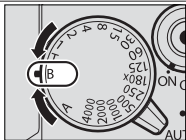

- 2 Press the shutter button all the way down. The shutter will remain open for up to 60 minutes while the shutter button is pressed; the display shows the time elapsed since the exposure started.



Selecting an aperture of **A** fixes shutter speed at 30 s.

To reduce “noise” (mottling) in long time-exposures, select **ON** for **IMAGE QUALITY SETTING > LONG EXPOSURE NR.** Note that this may increase the time needed to record images after shooting.

## Using a Remote Release

An optional RR-90 remote release can be used for long time-exposures. The RR-90 connects via the Micro USB (Micro-B) USB 2.0 connector.

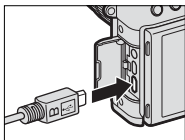

Alternatively, electronic releases from third-party suppliers can be connected via the microphone/remote release connector (ø2.5 mm 3-pole mini jack).

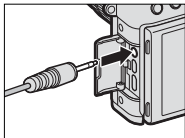

Third-party mechanical releases connect as shown.

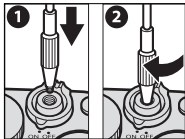

A confirmation dialog will be displayed when a third-party release is connected; press **MENU/OK** and select **REMOTE** for **MIC/REMOTE RELEASE**.

CHECK MIC/REMOTE RELEASE  
SETTING  
**OK** SET **EXIT** SKIP



## Mode A: Aperture-Priority AE

Choose an aperture and let the camera adjust shutter speed for optimal exposure.

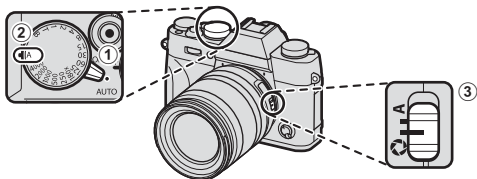



Adjust settings as follows:

- ① **Auto mode selector lever:** ●
- ② **Shutter speed:** A (auto)
- ③ **Aperture:** Select  and rotate the lens aperture ring to adjust aperture

Confirm that **A** appears in the display.



 If the correct exposure can not be achieved at the selected aperture, shutter speed will be displayed in red. If the subject is outside the metering range of the camera, the shutter speed display will show “— — —”.

 Aperture can be adjusted even while the shutter button is pressed halfway.

## Previewing Depth of Field

When **PREVIEW DEPTH OF FIELD** is assigned to a function button, pressing the button stops aperture down to the selected setting, allowing depth of field to be previewed in the display.

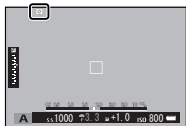

If both **AF DISTANCE INDICATOR** and **MF DISTANCE INDICATOR** are selected in the **SCREEN SETTING > DISP. CUSTOM SETTING** list, depth of field can also be previewed using the depth-of-field indicator in the standard display. Use the **DISP/BACK** button to display standard indicators.

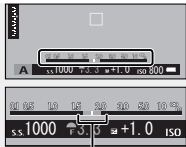

*Depth of field*

Use the **AF/MF SETTING > DEPTH-OF-FIELD SCALE** option to choose how depth of field is displayed. Choose **FILM FORMAT BASIS** to help you make practical assessments of depth of field for pictures that will be viewed as prints and the like, **PIXEL BASIS** to help you assess depth of field for pictures that will be viewed at high resolutions on computers or other electronic displays.

**Sensitivity and Motion Blur**

If you choose a narrow aperture when the subject is poorly lit, the shutter speed selected by the autoexposure program may not be fast enough to prevent motion blur. For faster shutter speeds that reduce motion blur, select a higher sensitivity.

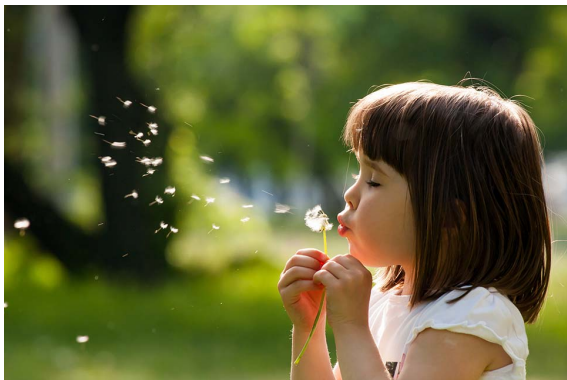

## Mode M: Manual Exposure

Alter exposure from that selected by the camera.

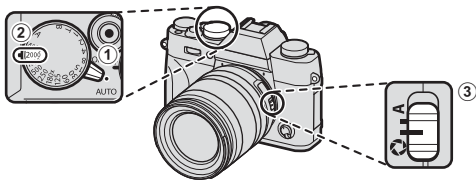

Adjust settings as follows:

- 1 **Auto mode selector lever:** ●
- 2 **Shutter speed:** Choose a shutter speed
- 3 **Aperture:** Select  and rotate the lens aperture ring to adjust aperture

Confirm that **M** appears in the display. The amount the picture would be under- or over-exposed at current settings is shown by the exposure indicator; adjust shutter speed and aperture until the desired exposure is reached.

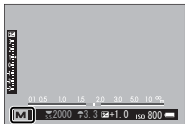

 At settings other than **180X**, shutter speed can also be adjusted in increments of  $\frac{1}{3}$  EV by rotating the front command dial.

**Exposure Preview**

To preview exposure in the LCD monitor, select an option other than **OFF** for **SCREEN SETTING > PREVIEW EXP./WB IN MANUAL MODE**. Select **OFF** when using the flash or on other occasions on which exposure may change when the picture is taken.



## Auto Mode

Auto mode offers options suited to particular subject types.

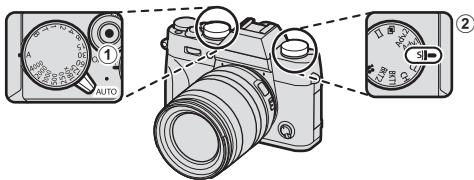







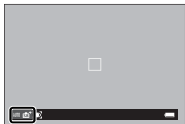





Adjust settings as follows:

- 1 **Auto mode selector lever: AUTO**
- 2 **Drive dial: S** (single frame)

The currently-selected scene appears in the display. Rotate the front command dial (or use the **SHOOTING SETTING > SCENE POSITION** item in the shooting menu) to choose from the following options:



Mode	Description
<b>SR+ ADVANCED SR AUTO</b>	The camera automatically optimizes settings to suit the scene.
<b>PORTRAIT</b>	Choose for portraits.

Mode	Description
 <b>PORTRAIT ENHANCER</b>	Processes portraits to give the subject a smooth, natural-looking complexion.
 <b>LANDSCAPE</b>	Choose for daylight shots of buildings and landscapes.
 <b>SPORT</b>	Choose when photographing moving subjects.
 <b>NIGHT</b>	Choose for poorly lit twilight or night scenes.
 <b>NIGHT (TRIPOD)</b>	Choose this mode for slow shutter speeds when shooting at night.
 <b>FIREWORKS</b>	Slow shutter speeds are used to capture the expanding burst of light from a firework.
 <b>SUNSET</b>	Choose this mode to record the vivid colors in sunrises and sunsets.
 <b>SNOW</b>	Choose for crisp, clear shots that capture the brightness of scenes dominated by shining white snow.
 <b>BEACH</b>	Choose for crisp, clear shots that capture the brightness of sunlit beaches.
 <b>UNDERWATER</b>	Reduces the blue cast typically associated with underwater lighting.
 <b>PARTY</b>	Capture indoor background lighting under low-light conditions.
 <b>FLOWER</b>	Effective for taking more vivid shots of flowers.
 <b>TEXT</b>	Take clear pictures of text or drawings in print.

## SR+ ADVANCED SR AUTO

The scene selected by the camera in **SR+ ADVANCED SR AUTO** mode is shown by an icon in the display.

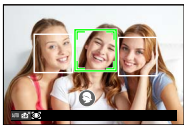

- AUTO
- LANDSCAPE
- NIGHT
- NIGHT (TRIPOD)
- MACRO
- SUNSET
- SKY
- SKY & GREENERY
- BACKLIT PORTRAIT
- PORTRAIT&MOTION
- BEACH
- SNOW
- GREENERY
- PORTRAIT
- MOVING OBJECT
- BACKLIT PORTRAIT&MOTION

The mode selected may vary with shooting conditions. If the mode and subject do not match, select a scene manually.



## Autofocus

Take pictures using autofocus.

- 1 Rotate the focus mode selector to **S** or **C** (📖 78).

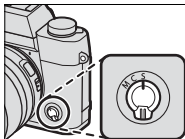

- 2 Use **AF/MF SETTING > AF MODE** to choose an AF mode (📖 80).

- 3 Choose the position and size of the focus frame (📖 82).

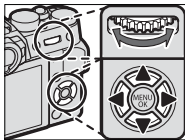

- 4 Take pictures.



For information on the autofocus system, visit:  
<http://fujifilm-x.com/af/en/index.html>

## Focus Mode

Use the focus mode selector to choose how the camera focuses.

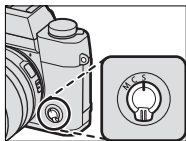

Choose from the following options:

Mode	Description
<b>S</b> (AF-S)	<b>Single AF:</b> Focus locks while the shutter button is pressed halfway. Choose for stationary subjects.
<b>C</b> (AF-C)	<b>Continuous AF:</b> Focus is continually adjusted to reflect changes in the distance to the subject while the shutter button is pressed halfway. Use for subjects that are in motion. Eye-detection AF is not available.
<b>M</b> (manual)	<b>Manual:</b> Focus manually using the lens focus ring. Choose for manual control of focus or in situations in which the camera is unable to focus using autofocus (📖 87).

 Regardless of the option selected, manual focus will be used when the lens is in manual focus mode.

If **ON** is selected for **AF/MF SETTING > PRE-AF**, focus will be adjusted continuously in modes **S** and **C** even when the shutter button is not pressed.

### The Focus Indicator

The focus indicator turns green when the subject is in focus and blinks white when the camera is unable to focus. Brackets (“( )”) indicate that the camera is focusing and are displayed continuously in mode **C**. **MF** is displayed in manual focus mode.



*Focus indicator*

## Autofocus Options (AF Mode)





Choose how the camera focuses in modes **S** and **C**.

- 1 Press **MENU/OK** and go to the shooting menu.
- 2 Select **AF/MF SETTING > AF MODE**.
- 3 Choose an AF mode.



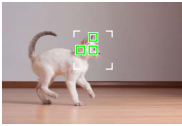

 This feature can also be accessed via shortcuts (📖 242).

How the camera focuses depends on the focus mode.

### Focus Mode **S** (AF-S)

Option	Description	Sample image
 <b>SINGLE POINT</b>	Camera focuses on subject in selected focus point. Use for pinpoint focus on selected subject.	
 <b>ZONE</b>	Camera focuses on subject in selected focus zone. Focus zones include multiple focus points, making it easier to focus on subjects in motion.	
 <b>WIDE/ TRACKING</b>	Camera focuses automatically on high-contrast subjects; display shows areas in focus.	

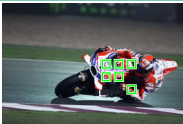

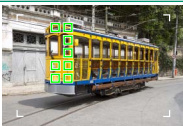
**Focus Mode C (AF-C)**

Option	Description	Sample image
 <b>SINGLE POINT</b>	Focus tracks subject at selected focus point. Use for subjects moving toward or away from camera.	
 <b>ZONE</b>	Focus tracks subject in selected focus zone. Use for subjects that are moving fairly predictably.	
 <b>WIDE/ TRACKING</b>	Focus tracks subjects moving through wide area of frame.	

## Focus-Point Selection

Choose a focus point for autofocus.







### Viewing the Focus-Point Display

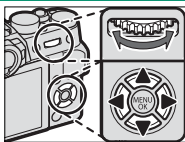

- 1 Press **MENU/OK** and go to the shooting menu.
- 2 Select  **AF/MF SETTING** > **FOCUS AREA** to view the focus-point display.
- 3 Use the selector and rear command dial to choose a focus area ( 83).

## Selecting a Focus Point

Use the selector to choose the focus point and the rear command dial to choose the size of the focus frame. The procedure varies with the option selected for AF mode.









	Selector	DISP/BACK button	Rear command dial	
<b>AF mode</b>	 <b>Press</b>	 <b>Press</b>	 <b>Rotate</b>	 <b>Press</b>
	Select focus point	Select center focus point	Choose from 5 frame sizes	Restore original size
			Choose from 3 frame sizes	
				

 Manual focus-point selection is not available when  **WIDE/TRACKING** is selected in focus mode **S**.

## The Focus-Point Display

The focus-point display varies with the option selected for AF mode.

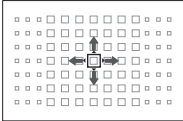
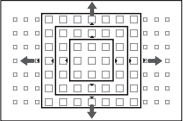
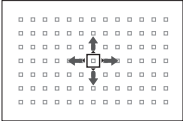
 Focus frames are shown by small squares (□), focus zones by the large squares.

AF mode		
 SINGLE POINT	 ZONE	 WIDE/TRACKING
		
Number of points available can be selected using  <b>AF/MF SETTING &gt; NUMBER OF THE FOCUS POINTS.</b>	Choose from zones with $7 \times 7$ , $5 \times 5$ , or $3 \times 3$ focus points.	Position focus frame over subject and press <b>MENU/OK.</b>

### Available Focus Points

TTL contrast-detect AF offers more focus points (①) than intelligent hybrid AF (②), which combines phase-detection with TTL contrast-detect AF.

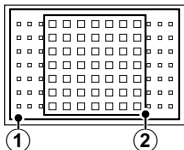



### Burst Mode Focus-Frame Selection

When continuous high-speed (**CH**) is selected for drive mode, the number of focus frames available in focus mode **C** drops.

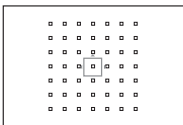

*Single point*

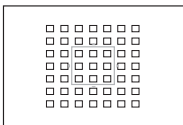

*Zone*

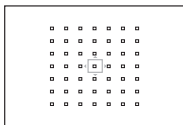

*Wide/tracking*

### Autofocus

Although the camera boasts a high-precision autofocus system, it may be unable to focus on the subjects listed below.

- Very shiny subjects such as mirrors or car bodies.
- Subjects photographed through a window or other reflective object.
- Dark subjects and subjects that absorb rather than reflect light, such as hair or fur.
- Insubstantial subjects, such as smoke or flame.
- Subjects that show little contrast with the background.
- Subjects positioned in front of or behind a high-contrast object that is also in the focus frame (for example, a subject photographed against a backdrop of highly contrasting elements).

## Checking Focus

To zoom in on the current focus area for precise focus, press the center of the rear command dial. Press the center of the rear command dial again to cancel zoom.

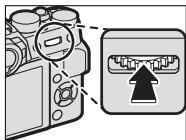

Normal display



Focus zoom



In focus mode **S**, zoom can be adjusted by rotating the rear command dial when **STANDARD** or **FOCUS PEAK HIGHLIGHT** is selected for **AF/MF SETTING > MF ASSIST** (📖 141). Focus zoom is not available in focus mode **C** or when **AF/MF SETTING > PRE-AF** is on or an option other than **SINGLE POINT** is selected for **AF MODE**.

Use **FUNCTION SETTING > Fn/AE-L/AF-L BUTTON SETTING** to change the function performed by the center of the command dial or assign its default function to other controls.

## Manual Focus

Adjust focus manually.

- 1 Rotate the focus mode selector to M.

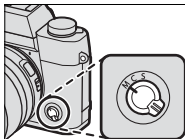

**MF** will appear in the display.

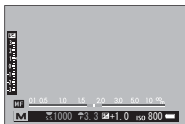

- 2 Focus manually using the lens focus ring. Rotate the ring left to reduce the focus distance, right to increase.

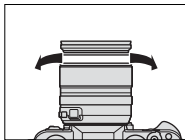

- 3 Take pictures.

Use **FUNCTION/DIAL SETTING > FOCUS RING** to reverse the direction of rotation of the focus ring.

Regardless of the option selected, manual focus will be used when the lens is in manual focus mode.

## Quick Focus

To use autofocus to focus on the subject in the selected focus area, press the button to which focus lock or AF-ON has been assigned (the size of the focus area can be chosen with the rear command dial). In manual focus mode, you can use this feature to quickly focus on a chosen subject using either single or continuous AF according to the option chosen for

 **AF/MF SETTING > INSTANT AF SETTING.**

## Checking Focus

A variety of options are available for checking focus in manual focus mode.

### The Manual Focus Indicator

The manual focus indicator indicates how closely the focus distance matches the distance to the subject in the focus brackets. The white line indicates the distance to the subject in the focus area (in meters or feet according to the option selected for **SCREEN SETTING > FOCUS SCALE UNITS** in the setup menu), the blue bar the depth of field, or in other words the distance in front of and behind the subject that appears to be in focus.

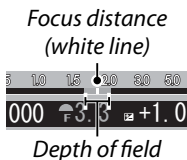

### Focus Zoom

If **ON** is selected for **AF/MF SETTING > FOCUS CHECK**, the camera will automatically zoom in on the selected focus area when the focus ring is rotated.

If **STANDARD** or **FOCUS PEAK HIGHLIGHT** is selected for **AF/MF SETTING > MF ASSIST**, zoom can be adjusted by rotating the rear command dial.

## MF Assist

The **AF/MF** **AF/MF SETTING** > **MF ASSIST** option can be used to check focus when pictures are framed in the LCD monitor or electronic viewfinder in manual focus mode.

 The **MF ASSIST** menu can be displayed by pressing and holding the center of the rear command dial.

The following options are available:

- **FOCUS PEAK HIGHLIGHT:** Highlights high-contrast outlines. Rotate the focus ring until the subject is highlighted.
- **DIGITAL SPLIT IMAGE:** Displays a split image in the center of the frame. Frame the subject in the split-image area and rotate the focus ring until the four parts of the split image are correctly aligned.

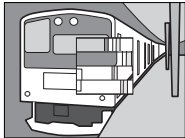



## Exposure Compensation

Adjust exposure.

Rotate the exposure compensation dial.

 The amount of compensation available varies with the shooting mode.

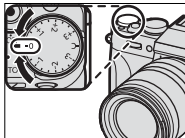

### C (Custom)

When the exposure compensation dial is rotated to **C**, exposure compensation can be adjusted by rotating the front command dial.

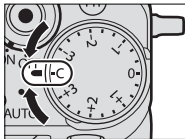

 The front command dial can be used to set exposure compensation to values between  $-5$  and  $+5$  EV.

The front command dial can be used to set aperture or exposure compensation. Press the dial to toggle between the two.

## Focus/Exposure Lock

Compose photographs with off-center subjects.

- 1 Focus:** Position the subject in the focus frame and press the shutter button halfway to lock focus and exposure. Focus and exposure will remain locked while the shutter button is pressed halfway (AF/AE lock).

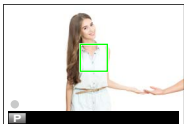

- 2 Recompose:** Keep the shutter button pressed halfway.



- 3 Shoot:** Press the button all the way down.



Focus lock using the shutter button is only available when **ON** is selected for **☑️ BUTTON/DIAL SETTING > SHUTTER AF, SHUTTER AE.**



## The AF-L and AE-L Buttons

Focus and exposure can also be locked with the **AF-L** and **AE-L** buttons. At default settings, the **AF-L** button locks focus, the **AE-L** button exposure. Focus and/or exposure will remain locked while the button is pressed, whether or not the shutter button is pressed halfway.

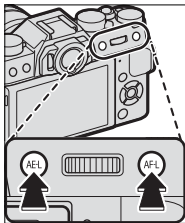

The roles of the buttons can be changed using the following **■ BUTTON/DIAL SETTING** options:

- **Fn/AE-L/AF-L BUTTON SETTING:** Choose the roles played by the **AE-L** and **AF-L** buttons.
- **AE/AF-LOCK MODE:** If **AE&AF ON/OFF SWITCH** is selected for **AE/AF-LOCK MODE**, focus and/or exposure lock when the button is pressed and remain locked until the button is pressed again.

## BKT Bracketing

Automatically vary settings over a series of pictures.

- 1 Rotate the drive dial to **BKT1** or **BKT2**.

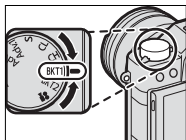

- 2 Navigate to **DRIVE SETTING** in the **SHOOTING SETTING** menu and select **AE BKT**, **ISO BKT**, **FILM SIMULATION BKT**, **WHITE BALANCE BKT**, or **DYNAMIC RANGE BKT**.

 This feature can also be accessed via shortcuts (📖 242).

- 3 Take photographs.

 **AE BKT**

Select a bracketing amount (options range from  $\pm\frac{1}{3}$  to  $\pm 2$  EV in increments of  $\frac{1}{3}$  EV). Each time the shutter button is pressed, the camera will take three shots: one using the metered value for exposure, the second overexposed by the selected amount, and the third underexposed by the same amount.



Regardless of the bracketing amount, exposure will not exceed the limits of the exposure metering system.

 **ISO BKT**

Select a bracketing amount ( $\pm 1$ ,  $\pm\frac{2}{3}$ , or  $\pm\frac{1}{3}$ ). Each time the shutter is released, the camera will take a picture at the current sensitivity and process it to create two additional copies, one with sensitivity raised and the other with sensitivity lowered by the selected amount.

 **FILM SIMULATION BKT**

Each time the shutter is released, the camera takes one shot and processes it to create copies with different film simulation settings, chosen using  **SHOOTING SETTING > BKT SETTING > FILM SIMULATION BKT**.

**WB WHITE BALANCE BKT**

Select a bracketing amount ( $\pm 1$ ,  $\pm 2/3$ , or  $\pm 1/3$ ). Each time the shutter is released, the camera takes one shot and processes it to create three copies: one at the current white balanced setting, one with fine-tuning increased by the selected amount, and another with fine-tuning decreased by the selected amount.

**DR DYNAMIC RANGE BKT**

Each time the shutter button is pressed, the camera takes three shots with different dynamic ranges: 100% for the first, 200% for the second, and 400% for the third.



While dynamic range bracketing is in effect, sensitivity will be restricted to a minimum of ISO 800 (or to a minimum of ISO 200 to 800 when an auto option is selected for sensitivity); the sensitivity previously in effect is restored when bracketing ends.



## Continuous Shooting (Burst Mode)

Capture motion in a series of pictures.

- 1 Rotate the drive dial to select **CH** (high-speed burst) or **CL** (low-speed burst).

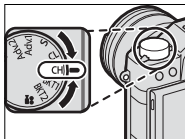

- 2 Navigate to **DRIVE SETTING** in the  **SHOOTING SETTING** menu and choose a frame advance rate.



This feature can also be accessed via shortcuts (📖 242).

- 3 Take photographs. The camera will take pictures while the shutter button is pressed; shooting ends when the shutter button is released or the memory card is full.



If file numbering reaches 999 before shooting is complete, the remaining pictures will be recorded to a new folder.

Burst shooting may not begin if the space available on the memory card is insufficient.

Frame rate varies with the subject, shutter speed, sensitivity, and focus mode. Frame rates may slow and recording times increase as more shots are taken.

The flash turns off automatically; the previously-selected flash mode is restored when burst shooting is disabled.

### Focus and Exposure

Select focus mode **C** to vary focus with shot; to vary exposure with each shot, select **OFF** for  **BUTTON/DIAL SETTING > SHUTTER AE**.



Selecting **CH** restricts the choice of focus frames in focus mode **C** and limits Intelligent Face Detection to the area used for intelligent hybrid AF (TTL contrast-detect AF+phase-detection AF;  84).

Exposure and focus tracking performance may vary with such factors as aperture, sensitivity, and exposure compensation.

## ADV. **Advanced Filters**

Take photos with filter effects.

- 1 Rotate the drive dial to **Adv.1** or **Adv.2**.

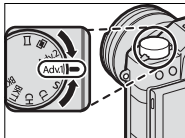













- 2 Navigate to **DRIVE SETTING** in the **SHOOTING SETTING** menu and choose a filter effect.

 This feature can also be accessed via shortcuts (📖 242).

- 3 Take photographs.

## Advanced Filter Options

Choose from the following filters:

Filter	Description
 <b>TOY CAMERA</b>	Choose for a retro toy camera effect.
 <b>MINIATURE</b>	The tops and bottoms of pictures are blurred for a diorama effect.
 <b>POP COLOR</b>	Create high-contrast images with saturated colors.
 <b>HIGH-KEY</b>	Create bright, low-contrast images.
 <b>LOW-KEY</b>	Create uniformly dark tones with few areas of emphasized highlights.
 <b>DYNAMIC TONE</b>	Dynamic tone expression is used for a fantasy effect.
 <b>SOFT FOCUS</b>	Create a look that is evenly soft throughout the whole image.
 <b>PARTIAL COLOR (RED)</b>	Areas of the image that are the selected color are recorded in that color. All other areas of the image are recorded in black-and-white.
 <b>PARTIAL COLOR (ORANGE)</b>	
 <b>PARTIAL COLOR (YELLOW)</b>	
 <b>PARTIAL COLOR (GREEN)</b>	
 <b>PARTIAL COLOR (BLUE)</b>	
 <b>PARTIAL COLOR (PURPLE)</b>	

 Depending on the subject and camera settings, images may in some cases be grainy or vary in brightness or hue.





## Multiple Exposures

Create a photograph that combines two exposures.

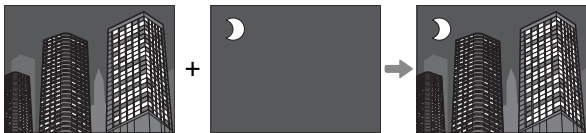

- 1 Rotate the drive dial to .

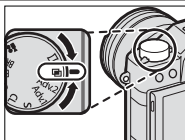

- 2 Take the first shot.
- 3 Press **MENU/OK**. The first shot will be shown superimposed on the view through the lens and you will be prompted to take the second shot.



To return to Step 2 and retake the first shot, press the selector left. To save the first shot and exit without creating a multiple exposure, press **DISP/BACK**.

- 4 Take the second shot, using the first frame as a guide.



- 5 Press **MENU/OK** to create the multiple exposure, or press the selector left to return to Step 4 and retake the second shot.





## Panoramas

Follow an on-screen guide to create a panorama.

- 1 Rotate the drive dial to .

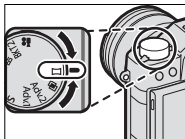

- 2 To select the size of the angle through which you will pan the camera while shooting, press the selector left. Highlight a size and press **MENU/OK**.
- 3 Press the selector right to view a choice of pan directions. Highlight a pan direction and press **MENU/OK**.
- 4 Press the shutter button all the way down to start recording. There is no need to keep the shutter button pressed during recording.

- 5 Pan the camera in the direction shown by the arrow. Shooting ends automatically when the camera is panned to the end of the guides and the panorama is complete.

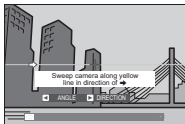

### **For Best Results**

For best results, use a lens with a focal length of 35 mm or less (50 mm or less in 35 mm format). Prop your elbows against your sides and move the camera slowly in a small circle at a steady speed, keeping the camera parallel or at right angles to the horizon and being careful only to pan in the direction shown by the guides. Use a tripod for best results. If the desired results are not achieved, try panning at a different speed.



If the shutter button is pressed all the way down before the panorama is complete, shooting will end and no panorama may be recorded. Shooting may also be interrupted if the camera is panned too quickly or too slowly. Panning the camera in a direction other than that shown cancels shooting.

Panoramas are created from multiple frames; if **ON** is selected for **☑️ BUTTON/DIAL SETTING > SHUTTER AE**, exposure for the entire panorama is determined by the first frame. The camera may in some cases record an greater or lesser angle than selected or be unable to stitch the frames together perfectly. The last part of the panorama may not be recorded if shooting ends before the panorama is complete.

The desired results may not be achieved with moving subjects, subjects close to the camera, unvarying subjects such as the sky or a field of grass, subjects that are in constant motion, such as waves and waterfalls, or subjects that undergo marked changes in brightness. Panoramas may be blurred if the subject is poorly lit.

## Viewing Panoramas

In full-frame playback, you can use the rear command dial to zoom panoramas in or out. Alternatively, you can play the panorama back using the selector.

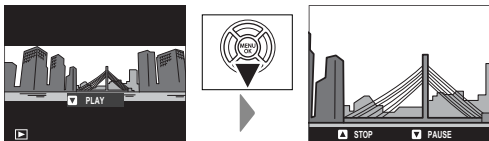

Press the selector down to start playback and press again to pause. While playback is paused, you can scroll the panorama manually by pressing the selector left or right; vertical panoramas will scroll vertically, horizontal panoramas horizontally. To exit to full-frame playback, press the selector up.

## Flash Photography

Use the built-in flash for additional lighting when shooting at night or indoors under low light.

- 1 Slide the ⚡ lever as shown to raise the flash.

⚠ Be careful not to injure yourself on the edges of the raised flash.

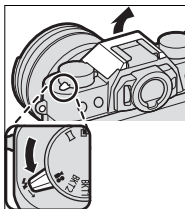

- 2 In the menus, navigate to **FLASH SETTING** > **FLASH FUNCTION SETTING** to display options for the built-in flash.

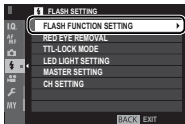

📖 This feature can also be accessed via shortcuts (📖 242).

- 3 Highlight items using the selector and rotate the rear command dial to change the highlighted setting (📖 109).

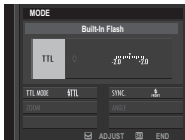



- 4 Press **DISP/BACK** to put the changes into effect.

 Depending on the distance to the subject, some lenses may cast shadows in photos taken with the flash.

The flash will not fire at some settings, for example in panorama mode or when the electronic shutter is used.

Choose shutter speeds slower than **180X** when using the flash in exposure mode **S** (shutter-priority AE) or manual (**M**).

 Except in commander mode, the flash will fire several times with each shot. Do not move the camera until shooting is complete.

The flash will not fire if **OFF** is selected for **SOUND & FLASH** in the  **USER SETTING** menu.



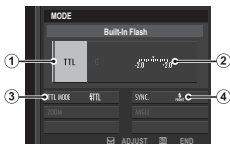

## Flash Settings

The following settings are available with the built-in flash.



Setting	Description
① Flash control mode	<p>Choose from the following options:</p> <ul style="list-style-type: none"> <li>• <b>TTL</b>: TTL mode. Adjust flash compensation (②) and choose a flash mode (③).</li> <li>• <b>M</b>: The flash fires at the selected output (②) regardless of subject brightness or camera settings. Output is expressed in fractions of full power, from 1/1 to 1/64. The desired results may not be achieved at low values if they exceed the limits of the flash control system; take a test shot and check the results.</li> <li>• <b>COMMANDER</b>: Choose if the flash is being used to control remote synced flash units, for example as part of a studio flash system.</li> <li>• <b>OFF</b>: The flash does not fire.</li> </ul>
② Flash compensation/output	Adjust flash level. The options available vary with the flash control mode (①).

Setting	Description
<p>③ Flash mode (TTL)</p>	<p>Choose a flash mode for TTL flash control. The options available vary with the shooting mode (<b>P</b>, <b>S</b>, <b>A</b>, or <b>M</b>) selected.</p> <ul style="list-style-type: none"> <li>• <b>TTL (FLASH AUTO)</b>: The flash fires only as required; flash level is adjusted according to subject brightness. A  icon displayed when the shutter button is pressed halfway indicates that the flash will fire when the photo is taken.</li> <li>• <b>TTL (STANDARD)</b>: The flash fires with every shot if possible; flash level is adjusted according to subject brightness. The flash will not fire if not fully charged when the shutter is released.</li> <li>• <b>TTL SLOW (SLOW SYNC.)</b>: Combine the flash with slow shutter speeds when photographing portrait subjects against a backdrop of night scenery. The flash will not fire if not fully charged when the shutter is released.</li> </ul>
<p>④ Sync</p>	<p>Choose whether the flash is timed to fire immediately after the shutter opens (/1ST CURTAIN) or immediately before it closes (/2ND CURTAIN). <b>1ST CURTAIN</b> is recommended in most circumstances.</p>

**Red-Eye Removal**

Red-eye removal is available when an option other than **OFF** is selected for **[F] FLASH SETTING > RED EYE REMOVAL** and **[AF/MF] AF/MF SETTING > FACE/EYE DETECTION SETTING** is **ON**. Red-eye removal minimizes “red-eye” caused when light from the flash is reflected from the subject’s retinas.

**Flash Sync Speed**

The flash will synchronize with the shutter at shutter speeds of  $\frac{1}{180}$  s or slower.

**Optional Flash Units from FUJIFILM**

The camera can be used with optional FUJIFILM shoe-mounted flash units.

**Third-Party Flash Units**

Do not use third-party flash units that apply over 300 V to the camera hot shoe.

# MEMO

---

---

---

---

---

---

---

---

---

---

---

---

---

---

---

---

---

---

---

---

---

---

---

---

---

# The Shooting Menus

6

## IMAGE QUALITY SETTING

Adjust image quality settings.

To display image quality settings, press **MENU/OK** in the shooting display and select the **I.Q.** (**IMAGE QUALITY SETTING**) tab.

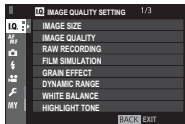

The options available vary with the shooting mode selected.

## IMAGE SIZE

Choose the size and aspect ratio at which still pictures are recorded.

Option	Image size	Option	Image size	Option	Image size
<b>L 3:2</b>	6000 × 4000	<b>L 16:9</b>	6000 × 3376	<b>L 1:1</b>	4000 × 4000
<b>M 3:2</b>	4240 × 2832	<b>M 16:9</b>	4240 × 2384	<b>M 1:1</b>	2832 × 2832
<b>S 3:2</b>	3008 × 2000	<b>S 16:9</b>	3008 × 1688	<b>S 1:1</b>	2000 × 2000

 **IMAGE SIZE** is not reset when the camera is turned off or another shooting mode is selected.

### Aspect Ratio

Pictures with an aspect ratio of 3:2 have the same proportions as a frame of 35 mm film, while an aspect ratio of 16:9 is suited to display on **H**igh **D**efinition (HD) devices. Pictures with an aspect ratio of 1:1 are square.

## IMAGE QUALITY

Choose a file format and compression ratio. Select **FINE** or **NORMAL** to record **JPEG** images, **RAW** to record RAW images, or **FINE+RAW** or **NORMAL+RAW** to record both JPEG and RAW images. **FINE** and **FINE+RAW** use lower JPEG compression ratios for higher-quality JPEG images, while **NORMAL** and **NORMAL+RAW** use higher JPEG compression ratios to increase the number of images that can be stored.

### The Function Buttons

To toggle RAW image quality on or off for a single shot, assign **RAW** to a function button (📖 250). If a JPEG option is currently selected for image quality, pressing the button temporarily selects the equivalent JPEG+RAW option. If a JPEG+RAW option is currently selected, pressing the button temporarily selects the equivalent JPEG option, while if **RAW** is selected, pressing the button temporarily selects **FINE**. Taking a picture or pressing the button again restores the previous setting.









**RAW RECORDING**



Choose whether to compress RAW images.

<b>Option</b>	<b>Description</b>
<b>UNCOMPRESSED</b>	RAW images are not compressed.
<b>LOSSLESS COMPRESSED</b>	RAW images are compressed using a reversible algorithm that reduces file size with no loss of image data. The images can be viewed in RAW FILE CONVERTER EX 2.0 or other software that supports "lossless" RAW compression.

## FILM SIMULATION

Simulate the effects of different kinds of film, including black-and-white (with or without color filters). Choose a palette according to your subject and creative intent.

Option	Description
 <b>PROVIA/ STANDARD</b>	Standard color reproduction. Suited to a wide range of subjects, from portraits to landscapes.
 <b>Velvia/VIVID</b>	A high-contrast palette of saturated colors, suited to nature photos.
 <b>ASTIA/SOFT</b>	Enhances the range of hues available for skin tones in portraits while preserving the bright blues of daylight skies. Recommended for outdoor portrait photography.
 <b>CLASSIC CHROME</b>	Soft color and enhanced shadow contrast for a calm look.
 <b>PRO Neg. Hi</b>	Offers slightly more contrast than  <b>PRO Neg. Std.</b> Recommended for outdoor portrait photography.
 <b>PRO Neg. Std</b>	A soft-toned palette. The range of hues available for skin tones is enhanced, making this a good choice for studio portrait photography.

Option	Description
 <b>ACROS*</b>	Take black-and-white photos with rich gradation and outstanding sharpness.
 <b>MONOCHROME*</b>	Take pictures in standard black and white.
 <b>SEPIA</b>	Take pictures in sepia.

\* Available with yellow (**Ye**), red (**R**), and green (**G**) filters, which deepen shades of gray corresponding to hues complementary to the selected color. The yellow (**Ye**) filter deepens purples and blues and the red (**R**) filter blues and greens. The green (**G**) filter deepens reds and browns, including skin tones, making it a good choice for portraits.

 Film simulation options can be combined with tone and sharpness settings.

Film simulation settings can also be accessed via shortcuts ( 242).

For more information, visit: <http://fujifilm-x.com/en/x-stories/the-world-of-film-simulation-episode-1/>

## GRAIN EFFECT

Add a film grain effect. Select an amount (**STRONG** or **WEAK**) or choose **OFF** to turn film grain off.

Options		
<b>STRONG</b>	<b>WEAK</b>	<b>OFF</b>

## DYNAMIC RANGE

Control contrast. Choose lower values to increase contrast when shooting indoors or under overcast skies, higher values to reduce loss of detail in highlights and shadows when photographing high-contrast scenes. Higher values are recommended for scenes that include both sunlight and deep shade, for such high-contrast subjects as sunlight on water, brightly-lit autumn leaves, and portraits taken against a blue sky, and for white objects or people wearing white; note, however, that mottling may appear in pictures taken at higher values.

Options			
<b>AUTO</b>	<b>☺100 100%</b>	<b>☺200 200%</b>	<b>☺400 400%</b>











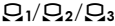

If **AUTO** is selected, the camera will automatically choose either **☺100 100%** or **☺200 200%** according to the subject and shooting conditions. Shutter speed and aperture will be displayed when the shutter button is pressed halfway.

**☺200 200%** is available at sensitivities of ISO 400 and above, **☺400 400%** at sensitivities of ISO 800 and above.

## WHITE BALANCE

For natural colors, choose a white balance option that matches the light source.

Option	Description
<b>AUTO</b>	White balance is adjusted automatically.
	Measure a value for white balance.
	Choose a color temperature.
	For subjects in direct sunlight.
	For subjects in the shade.
	Use under "daylight" fluorescent lights.
	Use under "warm white" fluorescent lights.
	Use under "cool white" fluorescent lights.
	Use under incandescent lighting.
	Reduces the blue cast typically associated with underwater lighting.

 Results vary with shooting conditions. Play pictures back after shooting to check colors.

White balance is adjusted for flash lighting only in **AUTO** and  modes. Turn the flash off using other white balance options.

White balance options can also be accessed via shortcuts ( 242).

## Fine-Tuning White Balance

Pressing **MENU/OK** after selecting a white balance option displays the dialog shown at right; use the selector to fine-tune white balance or press **DISP/BACK** to exit without fine-tuning.

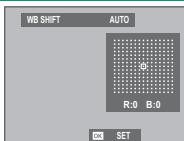

## Custom White Balance

Choose  $\mathcal{Q}_1$ ,  $\mathcal{Q}_2$ , or  $\mathcal{Q}_3$  to adjust white balance for unusual lighting conditions. White balance measurement options will be displayed; frame a white object so that it fills the display and press the shutter button all the way down to measure white balance (to select the most recent custom value and exit without measuring white balance, press **DISP/BACK**, or press **MENU/OK** to select the most recent value and display the fine-tuning dialog).

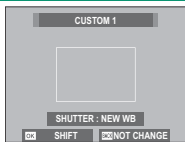

- If **"COMPLETED!"** is displayed, press **MENU/OK** to set white balance to the measured value.
- If **"UNDER"** is displayed, raise exposure compensation and try again.
- If **"OVER"** is displayed, lower exposure compensation and try again.



## **K**: Color Temperature

Selecting **K** in the white balance menu displays a list of color temperatures; highlight a color temperature and press **MENU/OK** to select the highlighted option and display the fine-tuning dialog.

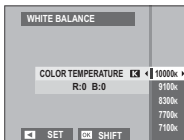

### Color Temperature

Color temperature is an objective measure of the color of a light source, expressed in Kelvin (K). Light sources with a color temperature close to that of direct sunlight appear white; light sources with a lower color temperature have a yellow or red cast, while those with a higher color temperature are tinged with blue. You can match color temperature to the light source, or choose options that differ sharply from the color of the light source to make pictures “warmer” or “colder.”

## HIGHLIGHT TONE

Adjust the appearance of highlights. Choose from seven options between +4 and -2.

Options						
+4	+3	+2	+1	0	-1	-2

## SHADOW TONE

Adjust the appearance of shadows. Choose from seven options between +4 and -2.

Options						
+4	+3	+2	+1	0	-1	-2

**COLOR**

Adjust color density. Choose from nine options between +4 and -4.

Options								
+4	+3	+2	+1	0	-1	-2	-3	-4

**SHARPNESS**

Sharpen or soften outlines. Choose from nine options between +4 and -4.

Options								
+4	+3	+2	+1	0	-1	-2	-3	-4

## NOISE REDUCTION

Reduce noise in pictures taken at high sensitivities. Choose from nine options between +4 and -4.

Options								
+4	+3	+2	+1	0	-1	-2	-3	-4

## LONG EXPOSURE NR

Select **ON** to reduce mottling in long time-exposures.

Options	
ON	OFF

## LENS MODULATION OPTIMIZER

Select **ON** to improve definition by adjusting for diffraction and the slight loss of focus at the periphery of the lens.

Options	
<b>ON</b>	<b>OFF</b>

## COLOR SPACE

Choose the gamut of colors available for color reproduction.

Option	Description
<b>sRGB</b>	Recommended in most situations.
<b>Adobe RGB</b>	For commercial printing.

## PIXEL MAPPING

Use this option if you notice bright spots in your pictures.

- 1 Press **MENU/OK** in the shooting display and select the  **IMAGE QUALITY SETTING** tab.
- 2 Highlight **PIXEL MAPPING** and press **MENU/OK** to perform pixel mapping. Processing may take a few seconds.



Results are not guaranteed.

Be sure the battery is fully charged before beginning pixel mapping.

Pixel mapping is not available when the camera temperature is elevated.

## SELECT CUSTOM SETTING

Recall settings saved with **EDIT/SAVE CUSTOM SETTING**. Settings can be recalled from any of the seven custom settings banks.

Banks			
CUSTOM 1	CUSTOM 2	CUSTOM 3	CUSTOM 4
CUSTOM 5	CUSTOM 6	CUSTOM 7	

## EDIT/SAVE CUSTOM SETTING

Save up to 7 sets of custom camera settings for commonly-encountered situations. Saved settings can be recalled using **Q IMAGE QUALITY SETTING > SELECT CUSTOM SETTING**.

- 1 Press **MENU/OK** in shooting mode to display the shooting menu. Select the **Q IMAGE QUALITY SETTING** tab, then highlight **EDIT/SAVE CUSTOM SETTING** and press **MENU/OK**.

- 2 Highlight a custom settings bank and press **MENU/OK** to select.



- 3 Adjust the following as desired:

- ISO
- DYNAMIC RANGE
- FILM SIMULATION
- GRAIN EFFECT
- WHITE BALANCE
- HIGHLIGHT TONE
- SHADOW TONE
- COLOR
- SHARPNESS
- NOISE REDUCTION

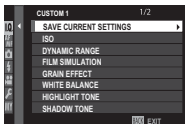

- 4 Press **DISP/BACK**. A confirmation dialog will be displayed; highlight **OK** and press **MENU/OK**.

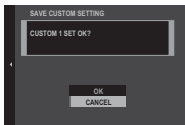

To store current camera settings in the selected bank, highlight **SAVE CURRENT SETTINGS** in Step 3 and press **MENU/OK**.





## AF/MF SETTING

Adjust focus settings.

To display focus settings, press **MENU/OK** in the shooting display and select the  (**AF/MF SETTING**) tab.

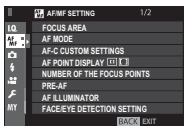





The options available vary with the shooting mode selected.

## FOCUS AREA

Choose the focus area for autofocus, manual focus, and focus zoom.

## AF MODE

Choose the AF mode for focus modes **S** and **C**.

Option	Description
 <b>SINGLE POINT</b>	The camera focuses on the subject in the selected focus point. The number of focus points available can be selected using  <b>AF/MF SETTING &gt; NUMBER OF THE FOCUS POINTS</b> . Use for pin-point focus on a selected subject.
 <b>ZONE</b>	The camera focuses on the subject in the selected focus zone. Focus zones include multiple focus points, making it easier to focus on subjects that are in motion.
 <b>WIDE/ TRACKING</b>	In focus mode <b>C</b> , the camera tracks focus on the subject in the selected focus point while the shutter button is pressed halfway. In focus mode <b>S</b> , the camera automatically focuses on high-contrast subjects; the areas in focus are shown in the display. The camera may be unable to focus on small objects or subjects that are moving rapidly.

## AF-C CUSTOM SETTINGS

Select focus-tracking options for focus mode C. Choose from Sets 1–5 according to your subject.

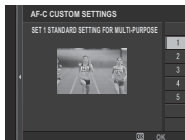

Option	Description
<b>SET 1 STANDARD SETTING FOR MULTI-PURPOSE</b>	A standard tracking option that works well with the typical range of moving subjects.
<b>SET 2 IGNORE OBSTACLES &amp; CONTINUE TO TRACK SUBJECT</b>	The focus system attempts to track the chosen subject. Choose with subjects that are hard to keep in the focus area or if other objects are likely to enter the focus area with the subject.
<b>SET 3 FOR ACCELERATING/ DECELERATING SUBJECT</b>	The focus system attempts to compensate for subject acceleration or deceleration. Choose for subjects prone to rapid changes in velocity.
<b>SET 4 FOR SUDDENLY APPEARING SUBJECT</b>	The focus system attempts to focus quickly on subjects entering the focus area. Choose for subjects that appear abruptly or when rapidly switching subjects.
<b>SET 5 FOR ERRATICALLY MOVING &amp; ACCEL./ DECEL. SUBJECT</b>	Choose for hard-to-track subjects prone not only to sudden changes in velocity but also to large movements front to back and left to right.

## AF POINT DISPLAY

Choose whether individual focus frames are displayed when **ZONE** or **WIDE/TRACKING** is selected for  **AF/MF SETTING > AF MODE**.

### Options

ON

OFF

## NUMBER OF THE FOCUS POINTS

Choose the number of focus points available for focus-point selection in manual focus mode or when **SINGLE POINT** is selected for **AF MODE**.

Option	Description
<b>91 POINTS</b> <b>(7 × 13)</b>	Choose from 91 focus points arranged in a 7- by 13-point grid.
<b>325 POINTS</b> <b>(13 × 25)</b>	Choose from 325 focus points arranged in a 13- by 25-point grid.

## PRE-AF

If **ON** is selected, the camera will continue to adjust focus even when the shutter button is not pressed halfway. Note that this increases the drain on the battery.

Options	
<b>ON</b>	<b>OFF</b>

## AF ILLUMINATOR

If **ON** is selected, the AF-assist illuminator will light to assist autofocus.

Options	
<b>ON</b>	<b>OFF</b>

 The camera may be unable to focus using the AF-assist illuminator in some cases. If the camera is unable to focus, try increasing the distance to the subject.

Avoid shining the AF-assist illuminator directly into your subject's eyes.

## FACE/EYE DETECTION SETTING

Intelligent Face Detection sets focus and exposure for human faces anywhere in the frame, preventing the camera from focusing on the background in group portraits. Choose for shots that emphasize portrait subjects. Faces can be detected with the camera in vertical or horizontal orientation; if a face is detected, it will be indicated by a green border. If there is more than one face in the frame, the camera will select the face closest to the center; other faces are indicated by white borders. You can also choose whether the camera detects and focuses on eyes when Intelligent Face Detection is on. Choose from the following options:

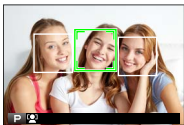

Option	Description
<b>FACE ON/EYE OFF</b>	Intelligent Face Detection only.
<b>FACE ON/EYE AUTO</b>	The camera automatically chooses which eye to focus on when a face is detected.
<b>FACE ON/RIGHT EYE PRIORITY</b>	The camera focuses on the right eye of subjects detected using Intelligent Face Detection.
<b>FACE ON/LEFT EYE PRIORITY</b>	The camera focuses on the left eye of subjects detected using Intelligent Face Detection.
<b>FACE OFF/EYE OFF</b>	Intelligent Face Detection and eye priority off.

 In some modes, the camera may set exposure for the frame as a whole rather than the portrait subject.

If the subject moves as the shutter button is pressed, the face may not be in the area indicated by the green border when the picture is taken.

 If the camera is unable to detect the subject's eyes because they are hidden by hair, glasses, or other objects, the camera will instead focus on faces.

Face/eye detection options can also be accessed via shortcuts ( 242).

## AF+MF

If **ON** is selected in focus mode **S**, focus can be adjusted manually by rotating the focus ring while the shutter button is pressed halfway. Both standard and focus peaking MF assist options are supported.

Options	
ON	OFF



Lenses with a focus distance indicator must be set to manual focus mode (MF) before this option can be used. Selecting MF disables the focus distance indicator. Set the focus ring to the center of the focus distance indicator, as the camera may fail to focus if the ring is set to infinity or the minimum focus distance.

### AF + MF Focus Zoom

When **ON** is selected for  **AF/MF SETTING** > **FOCUS CHECK** and **SINGLE POINT** selected for **AF MODE**, focus zoom can be used to zoom in on the selected focus area. The zoom ratio (2.5x or 6x) can be selected using the rear command dial.



**MF ASSIST**

Choose how focus is displayed in manual focus mode.

Option	Description
<b>STANDARD</b>	Focus is displayed normally (focus peaking and digital split image are not available).
<b>DIGITAL SPLIT IMAGE</b>	Displays a black-and-white ( <b>MONOCHROME</b> ) or color ( <b>COLOR</b> ) split image in the center of the frame. Frame the subject in the split-image area and rotate the focus ring until the three parts of the split image are correctly aligned.
<b>FOCUS PEAK HIGHLIGHT</b>	The camera heightens high-contrast outlines. Choose a color and peaking level.

**FOCUS CHECK**

If **ON** is selected, the display will automatically zoom in on the selected focus area when the focus ring is rotated in manual focus mode.

Options	
<b>ON</b>	<b>OFF</b>

 Pressing the center of the rear command dial cancels focus zoom.

## INTERLOCK SPOT AE & FOCUS AREA

Select **ON** to meter the current focus frame when **SINGLE POINT** is selected for **AF MODE** and **SPOT** is selected for **PHOTOMETRY**.

Options	
ON	OFF

## INSTANT AF SETTING

Choose whether the camera focuses using single AF (**AF-S**) or continuous AF (**AF-C**) when the **AF-L** button is pressed in manual focus mode.

Options	
AF-S	AF-C

## DEPTH-OF-FIELD SCALE

Choose **FILM FORMAT BASIS** to help you make practical assessments of depth of field for pictures that will be viewed as prints and the like, **PIXEL BASIS** to help you assess depth of field for pictures that will be viewed at high resolutions on computers or other electronic displays.

Options	
<b>PIXEL BASIS</b>	<b>FILM FORMAT BASIS</b>

## RELEASE/FOCUS PRIORITY





Choose how the camera focuses in focus mode **AF-S** or **AF-C**.

Option	Description
<b>RELEASE</b>	Shutter response is prioritized over focus. Pictures can be taken when the camera is not in focus.
<b>FOCUS</b>	Focus is prioritized over shutter response. Pictures can be only taken when the camera is in focus.

## TOUCH SCREEN MODE

Choose the shooting operations performed using touch controls.



### Still Photography



Mode	Description
<b>TOUCH SHOOTING</b> 	Tap your subject in the display to focus and release the shutter. In burst mode, pictures will be taken while you keep your finger on the display.
<b>AF</b> 	Tap to select a focus point. In focus mode <b>S</b> (AF-S), focus will lock, while in focus mode <b>C</b> (AF-C), the camera will continually adjust focus in response to changes in the distance to the subject. Focus lock and continuous focus can be ended by tapping the <b>AF OFF</b> icon.
<b>AREA</b> 	Tap to select a point for focus or zoom. The focus frame will move to the selected point.
<b>OFF</b> 	Touch controls off. The display does not respond when tapped.

## Movie Recording



We recommend that you select **AREA** for **MOVIE AF MODE** in the shooting menu  (movie) tab before recording movies using touch controls (in some movie modes, **AREA** will be selected automatically).

Mode	Description
<b>TOUCH SHOOTING</b> 	Tap your subject in the display to focus and start recording. In focus mode <b>C</b> (AF-C), the camera will continually adjust focus in response to changes in the distance to the subject; to refocus in focus mode <b>S</b> (AF-S) or to focus on a new subject in focus mode <b>C</b> , tap the subject in the monitor. <i>To end recording, press the shutter button.</i>
<b>AF</b> 	Tap your subject in the display to focus and <i>press the shutter button to start or end recording.</i> In focus mode <b>C</b> (AF-C), the camera will continually adjust focus in response to changes in the distance to the subject; to refocus in focus mode <b>S</b> (AF-S) or to focus on a new subject in focus mode <b>C</b> , tap the subject in the monitor.

Mode	Description
<p><b>AREA</b></p> 	<p>Tap to select a focus point and <i>press the shutter button to start or end recording</i>. In focus mode <b>C</b> (AF-C), the camera will continually adjust focus in response to changes in the distance to the subject in the selected focus point. In focus mode <b>S</b> (AF-S), you can move the focus point by tapping the display, but can only refocus using the control to which AF-ON has been assigned ( 225).</p>
<p><b>OFF</b></p> 	<p>Touch controls off. The display does not respond when tapped.</p>



To disable touch controls and hide the touch screen mode indicator, select **OFF** for  **BUTTON/DIAL SETTING > TOUCH SCREEN SETTING**.



## SHOOTING SETTING

Adjust shooting options.



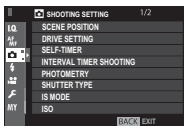



To display shooting options, press **MENU/OK** in the shooting display and select the  (**SHOOTING SETTING**) tab.











The options available vary with the shooting mode selected.

## SCENE POSITION

Choose the mode selected when the drive dial is rotated to **S** and the auto mode selector lever is rotated to **AUTO**.

Mode	Description
 <b>ADVANCED SR AUTO</b>	The camera automatically optimizes settings to suit the scene.
 <b>PORTRAIT</b>	Choose for portraits.
 <b>PORTRAIT ENHANCER</b>	Processes portraits to give the subject a smooth, natural-looking complexion.
 <b>LANDSCAPE</b>	Choose for daylight shots of buildings and landscapes.
 <b>SPORT</b>	Choose when photographing moving subjects.
 <b>NIGHT</b>	Choose for poorly lit twilight or night scenes.

Mode	Description
 <b>NIGHT (TRIPOD)</b>	Choose this mode for slow shutter speeds when shooting at night.
 <b>FIREWORKS</b>	Slow shutter speeds are used to capture the expanding burst of light from a firework.
 <b>SUNSET</b>	Choose this mode to record the vivid colors in sunrises and sunsets.
 <b>SNOW</b>	Choose for crisp, clear shots that capture the brightness of scenes dominated by shining white snow.
 <b>BEACH</b>	Choose for crisp, clear shots that capture the brightness of sunlit beaches.
 <b>UNDERWATER</b>	Reduces the blue cast typically associated with underwater lighting.
 <b>PARTY</b>	Capture indoor background lighting under low-light conditions.
 <b>FLOWER</b>	Effective for taking more vivid shots of flowers.
 <b>TEXT</b>	Take clear pictures of text or drawings in print.









## DRIVE SETTING

Adjust settings for the various drive modes.

Option	Description
<b>BKT1 SETTING</b>	Choose the settings used when the drive dial is rotated to <b>BKT1</b> or <b>BKT2</b> (📖 150).
<b>BKT2 SETTING</b>	
<b>CH HIGH SPEED BURST</b>	Select the frame rate used when the drive dial is rotated to <b>CH</b> (continuous high speed): 14, 11, or 8 fps. Note that <b>14fps</b> and <b>11fps</b> are available only with the electronic shutter.
<b>CL LOW SPEED BURST</b>	Select the frame rate used when the drive dial is rotated to <b>CL</b> (continuous low speed): 5, 4, or 3 fps.
<b>Adv. FILTER 1 SELECT</b>	Choose the filter used when the drive dial is rotated to <b>Adv.1</b> or <b>Adv.2</b> (📖 100).
<b>Adv. FILTER 2 SETTING</b>	



## BKT SETTING

Choose bracketing settings for the **BKT1** and **BKT2** positions on the drive dial. Use **BKT SELECT** to choose a bracketing type and the **AE BKT**, **ISO BKT**, **FILM SIMULATION BKT**, and **WHITE BALANCE BKT** options to choose the bracketing amount for each type.

Option	Description
<b>BKT SELECT</b>	Choose from  <b>AE BKT</b> ,  <b>ISO BKT</b> ,  <b>FILM SIMULATION BKT</b> ,  <b>WHITE BALANCE BKT</b> , and  <b>DYNAMIC RANGE BKT</b> .
<b>AE BKT</b>	Choose from $\pm\frac{1}{3}$ , $\pm\frac{2}{3}$ , $\pm 1$ , $\pm 1\frac{1}{3}$ , $\pm 1\frac{2}{3}$ , and $\pm 2$ .
<b>ISO BKT</b>	Choose from $\pm\frac{1}{3}$ , $\pm\frac{2}{3}$ , and $\pm 1$ .
<b>FILM SIMULATION BKT</b>	Choose the three film simulation types used for film simulation bracketing (  118).
<b>WHITE BALANCE BKT</b>	Choose from $\pm 1$ , $\pm 2$ , and $\pm 3$ .

## SELF-TIMER

Choose a shutter release delay.

Option	Description
 <b>2 SEC</b>	The shutter is released two seconds after the shutter button is pressed. Use to reduce blur caused by the camera moving when the shutter button is pressed. The self-timer lamp blinks as the timer counts down.
 <b>10 SEC</b>	The shutter is released ten seconds after the shutter button is pressed. Use for photographs in which you wish to appear yourself. The self-timer lamp blinks immediately before the picture is taken.
<b>OFF</b>	Self-timer off.

If an option other than **OFF** is selected, the timer will start when the shutter button is pressed all the way down. The display in the monitor shows the number of seconds remaining until the shutter is released. To stop the timer before the picture is taken, press **DISP/BACK**.



 Stand behind the camera when using the shutter button. Standing in front of the lens can interfere with focus and exposure.

The self-timer turns off automatically when the camera is turned off.

## INTERVAL TIMER SHOOTING

Configure the camera to take photos automatically at a preset interval.

- 1 Highlight **INTERVAL TIMER SHOOTING** in the  (**SHOOTING SETTING**) tab and press **MENU/OK**.

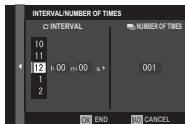

- 2 Use the selector to choose the interval and number of shots. Press **MENU/OK** to proceed.



- 3 Use the selector to choose the starting time and then press **MENU/OK**. Shooting will start automatically.





Interval timer photography can not be used at a shutter speed of **B** (bulb) or with multiple exposure photography. In burst mode, only one picture will be taken each time the shutter is released.



Use of a tripod is recommended.

Check the battery level before starting. We recommend using an optional AC-9V AC power adapter and CP-W126 DC coupler.





The display turns off between shots and lights a few seconds before the next shot is taken. The display can be activated at any time by pressing the shutter button.

To continue shooting until the memory card is full, set the number of shots to  $\infty$ .

## PHOTOMETRY

Choose how the camera meters exposure.

 The selected option will only take effect when **AF/MF SETTING > FACE/EYE DETECTION SETTING** is **OFF**.

Mode	Description
 (multi)	The camera instantly determines exposure based on an analysis of composition, color, and brightness distribution. Recommended in most situations.
 (center-weighted)	The camera meters the entire frame but assigns the greatest weight to the area at the center.
 (spot)	The camera meters lighting conditions in an area at the center of the frame equivalent to 2% of the total. Recommended with backlit subjects and in other cases in which the background is much brighter or darker than the main subject.
 (average)	Exposure is set to the average for the entire frame. Provides consistent exposure across multiple shots with the same lighting, and is particularly effective for landscapes and portraits of subjects dressed in black or white.

## SHUTTER TYPE

Choose the shutter type. Choose the electronic shutter to mute the shutter sound.

Option	Description
<b>MS MECHANICAL SHUTTER</b>	Take pictures with the mechanical shutter.
<b>ES ELECTRONIC SHUTTER</b>	Take pictures with the electronic shutter.
<b>MS MECHANICAL + ES ELECTRONIC</b>	The camera chooses the shutter type according to shooting conditions.



If an option other than **MS MECHANICAL SHUTTER** is selected, shutter speeds faster than  $\frac{1}{4000}$  s can be chosen by rotating the shutter speed dial to **4000** and then rotating the rear command dial.

 Distortion may be visible in shots of moving subjects with electronic shutter, while banding and fog may occur in shots taken under fluorescent lights or other flickering or erratic illumination. When taking pictures with the shutter muted, respect your subjects' image rights and right to privacy.

 When the electronic shutter is used, the flash is disabled, shutter speed and sensitivity are restricted to values of  $\frac{1}{32000}$ –30 s and ISO 12800–200 respectively, and long exposure noise reduction has no effect.

## IS MODE

Reduce blur.

Option	Description
 <b>CONTINUOUS</b>	Image stabilization on.
 <b>SHOOTING ONLY</b>	Image stabilization enabled only when the shutter button is pressed halfway (focus mode <b>C</b> ) or the shutter is released.
<b>OFF</b>	Image stabilization off;  appears in the display. Recommended when the camera is on a tripod.

 This option is available only with lenses that support image stabilization.



**ISO**

Adjust the camera's sensitivity to light.

Option	Description
<b>AUTO1</b> <b>AUTO2</b> <b>AUTO3</b>	Sensitivity is automatically adjusted in response to shooting conditions.
<b>12800–200</b>	Adjust sensitivity manually. Selected value is shown in display.
<b>H</b> (25600 or 51200), <b>L</b> (100)	Choose for special situations. Note that mottling may appear in pictures taken at <b>H</b> , while <b>L</b> reduces dynamic range.



Sensitivity is not reset when the camera is turned off.

**Adjusting Sensitivity**

High values can be used to reduce blur when lighting is poor, while lower values allow slower shutter speeds or wider apertures in bright light; note, however, that mottling may appear in pictures taken at high sensitivities.

## AUTO

Choose the base sensitivity, maximum sensitivity, and minimum shutter speed for **AUTO1**, **AUTO2**, and **AUTO3**. Defaults are shown below.

Option	Default		
	AUTO1	AUTO2	AUTO3
<b>DEFAULT SENSITIVITY</b>		200	
<b>MAX. SENSITIVITY</b>	800	1600	3200
<b>MIN. SHUTTER SPEED</b>		$\frac{1}{60}$ s	

The camera automatically chooses a sensitivity between the default and maximum values; sensitivity is only raised above the default value if the shutter speed required for optimal exposure would be slower than the value selected for **MIN. SHUTTER SPEED**.



If the value selected for **DEFAULT SENSITIVITY** is higher than that selected for **MAX. SENSITIVITY**, **DEFAULT SENSITIVITY** will be set to the value selected for **MAX. SENSITIVITY**.

The camera may select shutter speeds slower than **MIN. SHUTTER SPEED** if pictures would still be underexposed at the value selected for **MAX. SENSITIVITY**. If **AUTO** is selected for **MIN. SHUTTER SPEED**, the camera will automatically choose a minimum shutter speed approximately equal to the inverse of the lens' focal length, in seconds (for example, if the lens has a focal length of 50 mm, the camera will choose a minimum shutter speed in the neighborhood of  $\frac{1}{50}$  s). The minimum shutter speed is not affected by the option selected for image stabilization.

## MOUNT ADAPTOR SETTING

Adjust settings for M-mount lenses connected using an optional FUJIFILM M MOUNT ADAPTER.

### Choosing a Focal Length

If the lens has a focal length of 21, 24, 28, or 35 mm, choose a matching option in the **MOUNT ADAPTOR SETTING** menu.

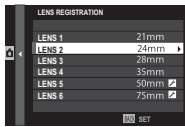

For other lenses, select option 5 or 6 and use the selector to enter the focal length.

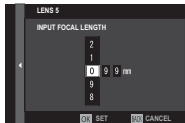

## Distortion Correction

Choose from **STRONG**, **MEDIUM**, or **WEAK** options to correct **BARREL** or **PINCUSHION** distortion.

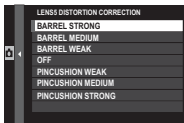

## Color Shading Correction

Color (shading) variations between the center and edges of the frame can be adjusted separately for each corner.

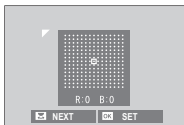

To use color shading correction, follow the steps below.

- 1 Rotate the rear command dial to choose a corner. The selected corner is indicated by a triangle.
- 2 Use the selector to adjust shading until there is no visible difference in color between the selected corner and the center of the image. Press the selector left or right to adjust colors on the cyan–red axis. Press the selector up or down to adjust colors on the blue–yellow axis.



To determine the amount required, adjust color shading correction while taking photos of blue sky or a sheet of gray paper.

## Peripheral Illumination Correction

Choose from values between  $-5$  and  $+5$ . Choosing positive values increases peripheral illumination, while choosing negative values reduces peripheral illumination.



Positive values are recommended for vintage lenses, negative values to create the effect of images taken with an antique lens or a pinhole camera.



To determine the amount required, adjust peripheral illumination correction while taking photos of blue sky or a sheet of gray paper.

## WIRELESS COMMUNICATION

Connect to smartphones running the “FUJIFILM Camera Remote” app. The smartphone can be used to browse the images on the camera, download selected images, control the camera remotely, or upload location data to the camera.



For downloads and other information, visit:

*<http://fujifilm-dsc.com/wifi/>*

## FLASH SETTING

Adjust flash-related settings.

To display flash-related settings, press **MENU/OK** in the shooting display and select the  (**FLASH SETTING**) tab.

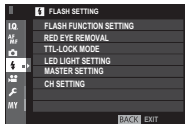

The options available vary with the shooting mode selected.

## FLASH FUNCTION SETTING

Choose a flash control mode, flash mode, or sync mode or adjust the flash level. The options available vary with the flash.

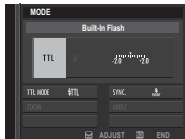

See page 257 for more information.



## RED EYE REMOVAL

Remove red-eye effects caused by the flash.

Option	Description
<b>FLASH + REMOVAL</b>	A red-eye reduction pre-flash is combined with digital red-eye removal.
<b>FLASH</b>	Flash red-eye reduction only.
<b>REMOVAL</b>	Digital red-eye removal only.
<b>OFF</b>	Flash red-eye reduction and digital red-eye removal off.

 Flash red-eye reduction can be used in TTL flash control mode. Digital red-eye removal is performed only when a face is detected and is not available with RAW images.

## TTL-LOCK MODE

Instead of adjusting flash level with each shot, TTL flash control can be locked for consistent results across a series of photographs.

Option	Description
<b>LOCK WITH LAST FLASH</b>	Flash output is locked at the value metered for the most recent photo. An error message will be displayed if no previously metered value exists.
<b>LOCK WITH METERING FLASH</b>	The camera emits a series of pre-flashes and locks flash output at the metered value.



To use TTL lock, assign **TTL-LOCK** to a camera control and then use the control to enable or disable TTL lock (📖 250).

Flash compensation can be adjusted while TTL lock is in effect.

## LED LIGHT SETTING

Choose whether to use the flash unit's LED video light (if available) as a catchlight or AF-assist illuminator when taking photos.

Option	Role of LED video light in still photography
<b>CATCHLIGHT</b>	Catchlight
<b>AF ASSIST</b>	AF-assist illuminator
<b>AF ASSIST + CATCHLIGHT</b>	AF-assist illuminator and catchlight
<b>OFF</b>	None



This option can also be accessed via the flash settings menu.

## MASTER SETTING

Choose a flash group (A, B, or C) for the flash mounted on the camera hot shoe when it functions as a master flash controlling remote flash units via FUJIFILM wireless optical flash control, or choose **OFF** to limit master flash output to a level that does not affect the final picture.

Options			
<b>Gr A</b>	<b>Gr B</b>	<b>Gr C</b>	<b>OFF</b>



This option can also be accessed via the flash settings menu.

## CH SETTING

Choose the channel used for communication between the master flash and remote flash units when using FUJIFILM optical wireless flash control. Separate channels can be used for different flash systems or to prevent interference when multiple systems are operating in close proximity.

Options			
CH1	CH2	CH3	CH4



## MOVIE SETTING

Adjust movie-recording options.



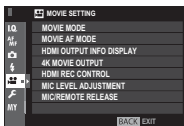













To display options for movie recording, press **MENU/OK** in the shooting display and select the  (**MOVIE SETTING**) tab.



The options available vary with the shooting mode selected.

## MOVIE MODE

Choose a frame size and rate for movie recording.

Option	Frame size	Rate
 2160/29.97P	3840 × 2160 (4K)	29.97 fps
 2160/25P		25 fps
 2160/24P		24 fps
 2160/23.98P		23.98 fps
 1080/59.94P	1920 × 1080 (Full HD)	59.94 fps
 1080/50P		50 fps
 1080/29.97P		29.97 fps
 1080/25P		25 fps
 1080/24P		24 fps
 1080/23.98P		23.98 fps
 720/59.94P	1280 × 720 (HD)	59.94 fps
 720/50P		50 fps
 720/29.97P		29.97 fps
 720/25P		25 fps
 720/24P		24 fps
 720/23.98P		23.98 fps

## MOVIE AF MODE

Choose how the camera selects the focus point for movie recording.

Option	Description
<b>MULTI</b>	Automatic focus-point selection.
<b>AREA</b>	The camera focuses on the subject in the selected focus area.

## HDMI OUTPUT INFO DISPLAY

If **ON** is selected, HDMI devices to which the camera is connected will mirror the information in the camera display.

Options	
<b>ON</b>	<b>OFF</b>

## 4K MOVIE OUTPUT

Choose the destination for 4K movies shot while the camera is connected to an HDMI recorder or other device that supports 4K.

Option	Description
 <b>CARD</b>	4K movies are recorded to a camera memory card in 4K and output to the HDMI device in Full HD.
<b>HDMI</b>	4K movies are output to the HDMI device in 4K, starting when the shutter button is pressed. The camera does not record 4K movies to a memory card.

## HDMI REC CONTROL

Choose whether the camera sends movie start and stop signals to the HDMI device when the shutter button is pressed to start and stop movie recording.

Options	
<b>ON</b>	<b>OFF</b>

## MIC LEVEL ADJUSTMENT

Adjust the recording level for the built-in and external microphones.

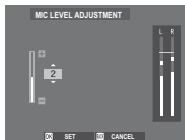

Option	Description
--------	-------------

4—1	Choose a recording level.
-----	---------------------------

 Displays shows the peak recording level detected in a given period.

You can assign **MIC LEVEL ADJUSTMENT** to a camera control and then using the control to adjust the microphone level during recording.

## MIC/REMOTE RELEASE

Specify whether the device connected to the microphone/remote release connector is a microphone or a remote release.

Options	
 MIC	 REMOTE



# Playback and the Playback Menu

# 7

## The Playback Display

This section lists the indicators that may be displayed during playback.



For illustrative purposes, displays are shown with all indicators lit.

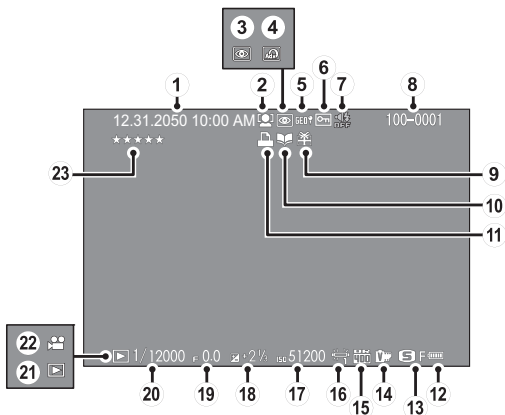

- |                                               |                                    |
|-----------------------------------------------|------------------------------------|
| ① Date and time..... 44, 202                  | ⑬ Image size/quality..... 115, 116 |
| ② Face detection indicator ..... 138          | ⑭ Film simulation ..... 118        |
| ③ Red-eye removal indicator<br>..... 165, 190 | ⑮ Dynamic range ..... 121          |
| ④ Advanced filter..... 99                     | ⑯ White balance ..... 122          |
| ⑤ Location data..... 238, 280                 | ⑰ Sensitivity..... 157             |
| ⑥ Protected image..... 188                    | ⑱ Exposure compensation..... 91    |
| ⑦ Sound and flash indicator ..... 206         | ⑲ Aperture..... 63, 69, 72         |
| ⑧ Frame number..... 234                       | ⑳ Shutter speed ..... 63, 64, 72   |
| ⑨ Gift image ..... 51                         | ㉑ Playback mode indicator ..... 51 |
| ⑩ Photobook assist indicator ..... 192        | ㉒ Movie icon..... 58               |
| ⑪ DPOF print indicator..... 195               | ㉓ Rating..... 176                  |
| ⑫ Battery level..... 43                       |                                    |

## The DISP/BACK Button

The **DISP/BACK** button controls the display of indicators during playback.

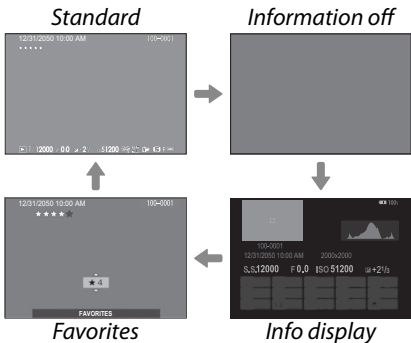
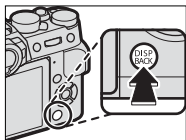

### Favorites: Rating Pictures

To rate the current picture, press **DISP/BACK** and press the selector up and down to select from zero to five stars.

## Viewing Photo Information

The photo information display changes each time the selector is pressed up.

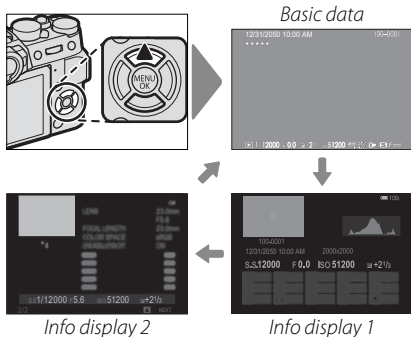

## Zooming in on the Focus Point

Press the center of the rear command dial to zoom in on the focus point. Press again to return to full-frame playback.



## Viewing Pictures

Read this section for information on playback zoom and multi-frame playback.

Use the rear command dial to go from full-frame playback to playback zoom or multi-frame playback.

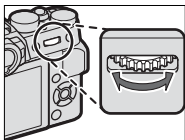

*Full-frame playback*



*Multi-frame playback*



*Nine-frame view*

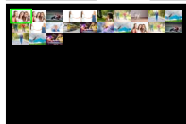

*Hundred-frame view*

*Playback zoom*

**DISP/BACK  
MENU/OK**



*Medium zoom*



*Maximum zoom*



## Playback Zoom

Rotate the rear command dial right to zoom in on the current picture, left to zoom out. To exit zoom, press **DISP/BACK, MENU/OK**, or the center of the rear command dial.

 The maximum zoom ratio varies with the option selected for **IQ IMAGE QUALITY SETTING > IMAGE SIZE**. Playback zoom is not available with cropped or resized copies saved at a size of **640**.

### Scroll

When the picture is zoomed in, the selector can be used to view areas of the image not currently visible in the display.



*Navigation window*

## Multi-Frame Playback

To change the number of images displayed, rotate the rear command dial left when a picture is displayed full frame.

 Use the selector to highlight images and press **MENU/OK** to view the highlighted image full frame. In the nine- and hundred-frame displays, press the selector up or down to view more pictures.

## The Playback Menu

Adjust playback settings.

The playback menu is displayed when you press **MENU/OK** in playback mode.

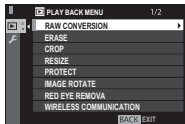

### RAW CONVERSION

RAW pictures store information on camera settings separately from the data captured by the camera image sensor. Using  **PLAY BACK MENU > RAW CONVERSION**, you can create JPEG copies of RAW pictures using different options for the settings listed on page 182. The original image data are unaffected, allowing a single RAW image to be processed in a multitude of different ways.

- 1 With a RAW picture displayed, press **MENU/OK** to display the playback menu.



- 2 Press the selector up or down to highlight **PLAY BACK MENU > RAW CONVERSION** and press **MENU/OK** to display settings.

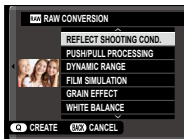

 These options can also be displayed by pressing the **Q** button during playback.

- 3 Press the selector up or down to highlight a setting and press the selector right to display options. Press the selector up or down to highlight the desired option and press **MENU/OK** to select and return to the settings list. Repeat this step to adjust additional settings.
- 4 Press the **Q** button to preview the JPEG copy and press **MENU/OK** to save.

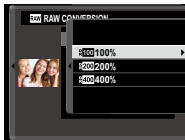

The settings that can be adjusted when converting pictures from RAW to JPEG are:

Setting	Description
<b>REFLECT SHOOTING COND.</b>	Create a JPEG copy using the settings in effect at the time the photo was taken.
<b>PUSH/PULL PROCESSING</b>	Adjust exposure.
<b>DYNAMIC RANGE</b>	Enhance details in highlights for natural contrast.
<b>FILM SIMULATION GRAIN EFFECT</b>	Simulate the effects of different types of film. Add a film grain effect.
<b>WHITE BALANCE</b>	Adjust white balance.
<b>WB SHIFT</b>	Fine-tune white balance.
<b>HIGHLIGHT TONE</b>	Adjust highlights.
<b>SHADOW TONE</b>	Adjust shadows.
<b>COLOR</b>	Adjust color density.
<b>SHARPNESS</b>	Sharpen or soften outlines.
<b>NOISE REDUCTION</b>	Process the copy to reduce mottling.
<b>LENS MODULATION OPTIMIZER</b>	Improve definition by adjusting for diffraction and the slight loss of focus at the periphery of the lens.
<b>COLOR SPACE</b>	Choose the color space used for color reproduction.

## ERASE

Delete individual pictures, multiple selected pictures, or all pictures.

 Deleted pictures can not be recovered. Protect important pictures or copy them to a computer or other storage device before proceeding.

Option	Description
<b>FRAME</b>	Delete pictures one at a time.
<b>SELECTED FRAMES</b>	Delete multiple selected pictures.
<b>ALL FRAMES</b>	Delete all unprotected pictures.

### FRAME

- 1 Select **FRAME** for **ERASE** in the playback menu.
- 2 Press the selector left or right to scroll through pictures and press **MENU/OK** to delete (a confirmation dialog is not displayed). Repeat to delete additional pictures.

## SELECTED FRAMES

---

- 1 Select **SELECTED FRAMES** for **ERASE** in the playback menu.
- 2 Highlight pictures and press **MENU/OK** to select or deselect (pictures in photobooks or printer orders are shown by **!**). Selected pictures are indicated by check marks (**✓**).
- 3 When the operation is complete, press **DISP/BACK** to display a confirmation dialog.
- 4 Highlight **OK** and press **MENU/OK** to delete the selected pictures.

## ALL FRAMES

- 1 Select **ALL FRAMES** for **ERASE** in the playback menu.
- 2 A confirmation dialog will be displayed; highlight **OK** and press **MENU/OK** to delete all unprotected pictures.



Pressing **DISP/BACK** cancels deletion; note that any pictures deleted before the button was pressed can not be recovered.

If a message appears stating that the selected images are part of a DPOF print order, press **MENU/OK** to delete the pictures.

## CROP

Create a cropped copy of the current picture.

---

- 1 Display the desired picture.
- 2 Select **CROP** in the playback menu.
- 3 Use the rear command dial to zoom in and out and press the selector up, down, left, or right to scroll the picture until the desired portion is displayed.
- 4 Press **MENU/OK** to display a confirmation dialog.
- 5 Press **MENU/OK** again to save the cropped copy to a separate file.



Larger crops produce larger copies; all copies have an aspect ratio of 3:2. If the size of the final copy will be **640**, **YES** will be displayed in yellow.

## RESIZE

Create a small copy of the current picture.

---

- 1 Display the desired picture.
- 2 Select **RESIZE** in the playback menu.
- 3 Highlight a size and press **MENU/OK** to display a confirmation dialog.
- 4 Press **MENU/OK** again to save the resized copy to a separate file.



The sizes available vary with the size of the original image.

## PROTECT

Protect pictures from accidental deletion. Highlight one of the following options and press **MENU/OK**.

- **FRAME:** Protect selected pictures. Press the selector left or right to view pictures and press **MENU/OK** to select or deselect. Press **DISP/BACK** when the operation is complete.
- **SET ALL:** Protect all pictures.
- **RESET ALL:** Remove protection from all pictures.



Protected pictures will be deleted when the memory card is formatted.



## IMAGE ROTATE

Rotate pictures.

- 1 Display the desired picture.
- 2 Select **IMAGE ROTATE** in the playback menu.
- 3 Press the selector down to rotate the picture 90° clockwise, up to rotate it 90° counterclockwise.
- 4 Press **MENU/OK**. The picture will automatically be displayed in the selected orientation whenever it is played back on the camera.



Protected pictures can not be rotated. Remove protection before rotating pictures.



The camera may not be able to rotate pictures created with other devices. Pictures rotated on the camera will not be rotated when viewed on a computer or on other cameras.

Pictures taken with **SCREEN SETTING > AUTOROTATE PB** are automatically displayed in the correct orientation during playback.

## RED EYE REMOVAL

Remove red-eye from portraits. The camera will analyze the image; if red-eye is detected, the image will be processed to create a copy with reduced red-eye.

- 1 Display the desired picture.
- 2 Select **RED EYE REMOVAL** in the playback menu.
- 3 Press **MENU/OK**.

 Results vary depending on the scene and the camera's success in detecting faces. Red eye can not be removed from pictures that have already been processed using red-eye removal, which are indicated by a  icon during playback.

The amount of time needed to process the image varies with the number of faces detected.

Red eye removal can not be performed on RAW images.

## WIRELESS COMMUNICATION

Connect to smartphones running the “FUJIFILM Camera Remote” app. The smartphone can be used to browse the images on the camera, download selected images, control the camera remotely, or upload location data to the camera.



For downloads and other information, visit:

<http://fujifilm-dsc.com/wifi/>

## SLIDE SHOW

View pictures in an automated slide show. Press **MENU/OK** to start and press the selector right or left to skip ahead or back. Press **DISP/BACK** at any time during the show to view on-screen help. The show can be ended at any time by pressing **MENU/OK**.



The camera will not turn off automatically while a slide show is in progress.

## PHOTOBOOK ASSIST

Create books from your favorite photos.

### Creating a Photobook

- 1 Select **NEW BOOK** for  **PLAY BACK MENU > PHOTOBOOK ASSIST**.
- 2 Scroll through the images and press the selector up to select or deselect. Press **MENU/OK** to exit when the book is complete.



Neither photographs **640** or smaller nor movies can be selected for photobooks.

The first picture selected becomes the cover image. Press the selector down to select the current image for the cover instead.

- 3 Highlight **COMPLETE PHOTOBOOK** and press **MENU/OK** (to select all photos for the book, choose **SELECT ALL**). The new book will be added to the list in the photobook assist menu.



Books can contain up to 300 pictures. Books that contain no photos are automatically deleted.

### Photobooks

Photobooks can be copied to a computer using MyFinePix Studio software.

## Viewing Photobooks

---

Highlight a book in the photobook assist menu and press **MENU/OK** to display the book, then press the selector left or right to scroll through the pictures.

## Editing and Deleting Photobooks

---

Display the photobook and press **MENU/OK**. The following options will be displayed; select the desired option and follow the on-screen instructions.

- **EDIT:** Edit the book as described in “Creating a Photobook”.
- **ERASE:** Delete the book.

## PC AUTO SAVE

Upload pictures from the camera to a computer running the “FUJIFILM PC AutoSave” application (note that you must first install the software and configure the computer as a destination for images copied from the camera).



For downloads and other information, visit:

*<http://fujifilm-dsc.com/wifi/>*

## PRINT ORDER (DPOF)

Create a digital “print order” for DPOF-compatible printers.

- 1 Select **PLAY BACK MENU > PRINT ORDER (DPOF)**.
- 2 Select **WITH DATE** to print the date of recording on pictures, **WITHOUT DATE** to print pictures without dates, or **RESET ALL** to remove all pictures from the print order before proceeding.
- 3 Display a picture you wish to include in or remove from the print order.
- 4 Press the selector up or down to choose the number of copies (up to 99). To remove a picture from the order, press the selector down until the number of copies is 0.

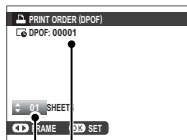

Total number of prints  
Number of copies

- 5 Repeat steps 3–4 to complete the print order.
- 6 The total number of prints is displayed in the monitor. Press **MENU/OK** to exit.



The pictures in the current print order are indicated by a  icon during playback.

Print orders can contain a maximum of 999 pictures.

If a memory card is inserted containing a print order created by another camera, a message will be displayed. Pressing **MENU/OK** cancels the print order; a new print order must be created as described above.



## instax PRINTER PRINT

To print pictures to optional FUJIFILM instax SHARE printers, first select **CONNECTION SETTING** > **instax PRINTER CONNECTION SETTING** and enter the instax SHARE printer name (SSID) and password, then follow the steps below.

- 1 Turn the printer on.
- 2 Select **PLAY BACK MENU** > **instax PRINTER PRINT**. The camera will connect to the printer.



 To print a frame from a burst sequence, display the frame before selecting **instax PRINTER PRINT**.

- 3 Use the selector to display the picture you want to print, then press **MENU/OK**. The picture will be sent to the printer and printing will start.





 Pictures taken with other cameras can not be printed.  
The area printed is smaller than the area visible in the LCD monitor.

## DISP ASPECT

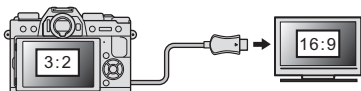
Choose how High Definition (HD) devices display pictures with an aspect ratio of 3:2 (this option is available only when an HDMI cable is connected). Select 16:9 to display the image so that it fills the screen with its top and bottom cropped out, 3:2 to display the entire image with black bands at either side.



		Option	
		16:9	3:2
Display			

# The Setup Menus

# 8



## USER SETTING

Adjust basic camera settings.

To access basic camera settings, press **MENU/OK**, select the  (**SET UP**) tab, and choose **USER SETTING**.

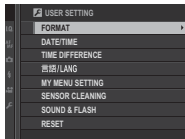

## FORMAT

To format a memory card:

- 1 Select **USER SETTING > FORMAT** in the **(SET UP)** tab.
- 2 A confirmation dialog will be displayed. To format the memory card, highlight **OK** and press **MENU/OK**. To exit without formatting the memory card, select **CANCEL** or press **DISP/BACK**.

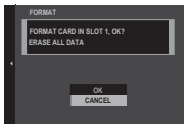

**!** All data—including protected pictures—will be deleted from the memory card. Be sure important files have been copied to a computer or other storage device.

Do not open the battery-chamber cover during formatting.

**📷** The format menu can also be displayed by pressing the center of the rear command dial while pressing and holding the **🗑️** button.

## DATE/TIME

To set the camera clock:

- 1 Select **USER SETTING** > **DATE/TIME** in the **(SET UP)** tab.
- 2 Press the selector left or right to highlight the year, month, day, hour, or minute and press up or down to change. To change the order in which the year, month, and day are displayed, highlight the date format and press the selector up or down.
- 3 Press **MENU/OK** to set the clock.

## TIME DIFFERENCE

Switch the camera clock instantly from your home time zone to the local time at your destination when traveling. To specify the difference between your local and home time zone:

- 1 Highlight **✚ LOCAL** and press **MENU/OK**.
- 2 Use the selector to choose the time difference between local time and your home time zone. Press **MENU/OK** when settings are complete.

To set the camera clock to local time, highlight **✚ LOCAL** and press **MENU/OK**. To set the clock to the time in your home time zone, select **🏠 HOME**. If **✚ LOCAL** is selected, **✚** will be displayed in yellow for about three seconds when the camera is turned on.

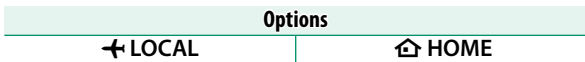

## 言語/LANG.

Choose a language.

## MY MENU SETTING

Edit the items listed in the **MY** (MY MENU) tab, a personalized custom menu of frequently-used options.

- 1 Highlight **USER SETTING** > **MY MENU SETTING** in the **SET UP** tab and press **MENU/OK** to display the options at right.

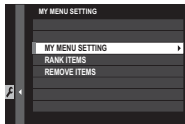



- 2 Press the selector up or down to highlight **MY MENU SETTING** and press **MENU/OK**. Options that can be added to “my menu” are highlighted in blue.

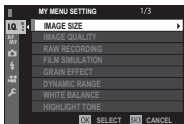

Items currently in “my menu” are indicated by check marks.

- 3 Highlight an item and press **MENU/OK** to add it to “my menu”.



- 4 Press **MENU/OK** to return to the edit display.
- 5 Repeat Steps 3 and 4 until all the desired items have been added.



“My menu” can contain up to 16 items.

### Editing “My Menu”

To reorder or delete items, select **RANK ITEMS** or **REMOVE ITEMS** in Step 1.

## SENSOR CLEANING

Remove dust from the camera image sensor.

- **OK:** Clean the sensor immediately.
- **WHEN SWITCHED ON:** Sensor cleaning will be performed when the camera is turned on.
- **WHEN SWITCHED OFF:** Sensor cleaning will be performed when the camera turns off (sensor cleaning is not however performed if the camera turns off in playback mode).



Dust that can not be removed using sensor cleaning can be removed manually.

## SOUND & FLASH

Select **OFF** to disable the speaker, flash, illuminator, and self-timer lamp in situations in which camera sounds and lights may be unwelcome.

Options

ON

OFF

## RESET

Reset shooting or setup menu options to default values. Custom white balance, custom settings banks created using **EDIT/SAVE CUSTOM SETTING**, **WIRELESS SETTINGS**, and the setup menu **DATE/TIME** and **TIME DIFFERENCE** options are not affected.

- 1 Highlight the desired option and press the selector right.
- 2 A confirmation dialog will be displayed; highlight **OK** and press **MENU/OK**.



## SOUND SETTING

Make changes to camera sounds.

To access sound settings, press **MENU/OK**, select the  (**SET UP**) tab, and choose **SOUND SETTING**.

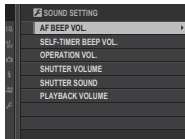

### AF BEEP VOL.

Choose the volume of the beep that sounds when the camera focuses. The beep can be muted by selecting  **OFF**.

#### Options

 (high)

 (medium)

 (low)

 **OFF** (mute)

## SELF-TIMER BEEP VOL.

Choose the volume of the beep that sounds while the self-timer is active. The beep can be muted by selecting  OFF.

### Options

 (high) (medium) (low) OFF (mute)

## OPERATION VOL.

Adjust the volume of the sounds produced when camera controls are operated. Choose  OFF to disable control sounds.

### Options

 (high) (medium) (low) OFF (mute)

## SHUTTER VOLUME

Adjust the volume of the sounds produced by the electronic shutter. Choose  OFF to disable the shutter sound.

### Options

 (high) (medium) (low) OFF (mute)

## SHUTTER SOUND

Choose the sound made by the electronic shutter.

### Options

 1 SOUND 1 2 SOUND 2 3 SOUND 3

**PLAYBACK VOLUME**

Adjust the volume for movie playback. Choose from 10 options between 10 (high) and 1 (low) or select **OFF** to mute audio during movie playback.

Options										
10	9	8	7	6	5	4	3	2	1	OFF

## SCREEN SETTING

Make changes to display settings.

To access display settings, press **MENU/OK**, select the  (**SET UP**) tab, and choose **SCREEN SETTING**.

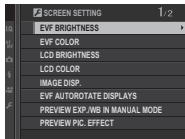

### EVF BRIGHTNESS

Adjust the brightness of the display in the electronic viewfinder. Select **MANUAL** to choose from 11 options from +5 (bright) to -5 (dark), or select **AUTO** for automatic brightness adjustment.

#### Options

**MANUAL**

**AUTO**



## EVF COLOR

Adjust the hue of the display in the electronic viewfinder. Choose from 11 options between +5 and -5.

Options										
+5	+4	+3	+2	+1	0	-1	-2	-3	-4	-5

## LCD BRIGHTNESS

Adjust monitor brightness. Choose from 11 options between +5 and -5.

Options										
+5	+4	+3	+2	+1	0	-1	-2	-3	-4	-5

## LCD COLOR

Adjust monitor hue. Choose from 11 options between +5 and -5.

Options										
+5	+4	+3	+2	+1	0	-1	-2	-3	-4	-5

## IMAGE DISP.

Choose how long images are displayed after shooting. Colors may differ slightly from those in the final image and “noise” mottling may be visible at high sensitivities.

Option	Description
<b>CONTINUOUS</b>	Pictures are displayed until the <b>MENU/OK</b> button is pressed or the shutter button is pressed halfway. To zoom in on the active focus point, press the center of the rear command dial; press again to cancel zoom.
<b>1.5 SEC</b>	Pictures are displayed for the selected time or until the shutter button is pressed halfway.
<b>0.5 SEC</b>	
<b>OFF</b>	Pictures are not displayed after shooting.

## EVF AUTOROTATE DISPLAYS

Choose whether the indicators in the viewfinder rotate to match camera orientation. Regardless of the option selected, the indicators in the monitor do not rotate.

Options	
ON	OFF

## PREVIEW EXP./WB IN MANUAL MODE

Select **PREVIEW EXP./WB** to enable exposure and white balance preview in manual exposure mode, or choose **PREVIEW WB** to preview only white balance (**PREVIEW WB** is recommended in situations in which exposure and white balance are likely to change during shooting, as may be the case when you use a flash with an incandescent monitoring lamp). Select **OFF** when using a flash or on other occasions on which exposure may change when the picture is taken.

Options		
PREVIEW EXP./WB	PREVIEW WB	OFF

## PREVIEW PIC. EFFECT

Choose **ON** to preview the effects of film simulation, white balance, and other settings in the monitor, **OFF** to make shadows in low-contrast, back-lit scenes and other hard-to-see subjects more visible.

### Options

**ON**







**OFF**



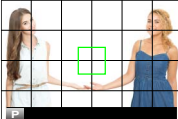

If **OFF** is selected, the effects of camera settings will not be visible in the monitor and colors and tone will differ from those in the final picture. The display will however be adjusted to show the effects of advanced filters and of monochrome and sepia settings.

## FRAMING GUIDELINE

Choose a framing grid for shooting mode.

		Option		
		 GRID 9	 GRID 24	 HD FRAMING
Display				
	For "rule of thirds" composition.	A six-by-four grid.	Frame HD pictures in the crop shown by the lines at the top and bottom of the display.	

 Framing guides are not shown at default settings but can be displayed using  **SCREEN SETTING** > **DISP. CUSTOM SETTING** ( 219).

## AUTOROTATE PB

Choose **ON** to automatically rotate “tall” (portrait-orientation) pictures during playback.

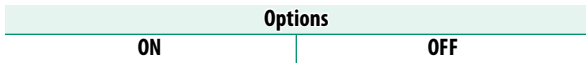

## FOCUS SCALE UNITS

Choose the units used for the focus distance indicator.

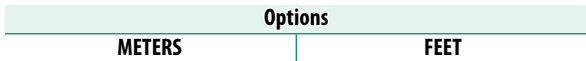

**DISP. CUSTOM SETTING**

Choose the items shown in the standard display.

- 1 In shooting mode, use the **DISP/BACK** button to display standard indicators.
- 2 Press **MENU/OK** and select **SCREEN SETTING > DISP. CUSTOM SETTING** in the **(SET UP)** tab.
- 3 Highlight items and press **MENU/OK** to select or deselect.

Item	Default	Item	Default
FRAMING GUIDELINE	<input type="checkbox"/>	SHUTTER TYPE	<input checked="" type="checkbox"/>
ELECTRONIC LEVEL	<input type="checkbox"/>	FLASH	<input checked="" type="checkbox"/>
FOCUS FRAME	<input checked="" type="checkbox"/>	CONTINUOUS MODE	<input checked="" type="checkbox"/>
AF DISTANCE INDICATOR	<input type="checkbox"/>	DUAL IS MODE	<input checked="" type="checkbox"/>
MF DISTANCE INDICATOR	<input checked="" type="checkbox"/>	TOUCH SCREEN MODE	<input checked="" type="checkbox"/>
HISTOGRAM	<input type="checkbox"/>	WHITE BALANCE	<input checked="" type="checkbox"/>
SHOOTING MODE	<input checked="" type="checkbox"/>	FILM SIMULATION	<input checked="" type="checkbox"/>
APERTURE/S-SPEED/ISO	<input checked="" type="checkbox"/>	DYNAMIC RANGE	<input checked="" type="checkbox"/>
INFORMATION BACKGROUND	<input checked="" type="checkbox"/>	FRAMES REMAINING	<input checked="" type="checkbox"/>
Expo. Comp. (Digit)	<input type="checkbox"/>	IMAGE SIZE/QUALITY	<input checked="" type="checkbox"/>
Expo. Comp. (Scale)	<input checked="" type="checkbox"/>	MOVIE MODE & REC. TIME	<input checked="" type="checkbox"/>
FOCUS MODE	<input checked="" type="checkbox"/>	BATTERY LEVEL	<input checked="" type="checkbox"/>
PHOTOMETRY	<input checked="" type="checkbox"/>	FRAMING OUTLINE	<input type="checkbox"/>

- 4 Press **DISP/BACK** to save changes.
- 5 Press **DISP/BACK** as needed to exit the menus and return to the shooting display.





## BUTTON/DIAL SETTING

Access options for camera controls.

To access control options, press **MENU/OK**, select the  (**SET UP**) tab, and choose **BUTTON/DIAL SETTING**.

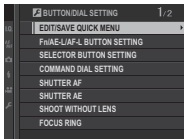

## EDIT/SAVE QUICK MENU

Choose the items displayed in the quick menu.

1 Select **FUNCTION** **BUTTON/DIAL SETTING** > **EDIT/SAVE QUICK MENU** in the **FUNCTION** (**SET UP**) tab.

2 The current quick menu will be displayed; use the selector to highlight the item you wish to change and press **MENU/OK**.

3 Highlight any of the following options and press **MENU/OK** to assign it to the selected position.

- IMAGE SIZE
- IMAGE QUALITY
- FILM SIMULATION\*
- GRAIN EFFECT\*
- DYNAMIC RANGE\*
- WHITE BALANCE\*
- HIGHLIGHT TONE\*
- SHADOW TONE\*
- COLOR\*
- SHARPNESS\*
- NOISE REDUCTION\*
- SELECT CUSTOM SETTING\*
- AF MODE
- AF-C CUSTOM SETTINGS
- FACE/EYE DETECTION SETTING
- MF ASSIST
- SELF-TIMER
- PHOTOMETRY
- SHUTTER TYPE
- ISO
- TOUCH SCREEN MODE
- FLASH FUNCTION SETTING
- FLASH COMPENSATION
- MOVIE MODE
- MIC LEVEL ADJUSTMENT
- SOUND & FLASH
- EVF/LCD BRIGHTNESS
- EVF/LCD COLOR
- NONE

\* Stored in custom settings bank.

 Select **NONE** to assign no option to the selected position. When **SELECT CUSTOM SETTING** is selected, current settings are shown in the quick menu by the label **BASE**.

**4** Highlight the desired item and press **MENU/OK** to assign it to the selected position.

 The quick menu can also be accessed in shooting mode by holding the **Q** button.

## **Fn/AE-L/AF-L BUTTON SETTING**

Choose the roles played by the function buttons.

**1** Select **FUNCTION BUTTON/DIAL SETTING > Fn/AE-L/AF-L BUTTON SETTING** in the **FUNCTION (SET UP)** tab.

**2** Highlight the desired control and press **MENU/OK**.

**3** Highlight any of the following options and press **MENU/OK** to assign it to the selected control.

- IMAGE SIZE
- IMAGE QUALITY
- RAW
- FILM SIMULATION
- GRAIN EFFECT
- DYNAMIC RANGE
- WHITE BALANCE
- SELECT CUSTOM SETTING
- FOCUS AREA
- FOCUS CHECK
- AF MODE
- AF-C CUSTOM SETTINGS
- FACE/EYE DETECTION SETTING
- DRIVE SETTING
- SELF-TIMER
- PHOTOMETRY
- SHUTTER TYPE
- ISO
- WIRELESS COMMUNICATION
- FLASH FUNCTION SETTING
- TTL-LOCK
- MODELING FLASH
- MIC LEVEL ADJUSTMENT
- PREVIEW DEPTH OF FIELD
- PREVIEWEXP/WBINMANUALMODE
- PREVIEW PIC. EFFECT
- AE LOCK ONLY
- AF LOCK ONLY
- AE/AF LOCK
- AF-ON
- APERTURE SETTING
- PLAYBACK
- NONE (control disabled)



Function button assignment options can also be accessed by holding the **DISP/BACK** button. The selector can not be assigned more than one role at a time.

## AF-ON

---

If **AF-ON** is selected, you can press the control instead of keeping the shutter button pressed halfway.

## MODELING FLASH

---

If **MODELING FLASH** is selected when a compatible shoe-mounted flash unit is attached, you can press the control to test-fire the flash and check for shadows and the like (modeling flash).

## TTL-LOCK

---

If **TTL-LOCK** is selected, you can press the control to lock flash output according to the option selected for **⚡ FLASH SETTING > TTL-LOCK MODE** ( 166).

## SELECTOR BUTTON SETTING

Choose the roles played by the up, down, left, and right buttons on the selector.

Option	Description
<b>Fn BUTTON</b>	The selector buttons serve as function buttons.
<b>FOCUS AREA</b>	The selector buttons can be used to position the focus area.



Selecting **FOCUS AREA** prevents you accessing the functions assigned to the function buttons.

## COMMAND DIAL SETTING

Choose the roles played by the command dials.

Option	Description
<b>▲ F ▼ S.S.</b>	The front command dial controls aperture, the rear command dial shutter speed.
<b>▲ S.S. ▼ F</b>	The front command dial controls shutter speed, the rear command dial aperture.

## SHUTTER AF

Choose whether the camera focuses when the shutter button is pressed halfway.

Option	Description
<b>ON</b>	In <b>focus mode S (AF-S)</b> , the camera focuses when the shutter button is pressed halfway and locks focus while the button remains in this position. In <b>focus mode C (AF-C)</b> , focus is adjusted continually while the button is pressed halfway.
<b>OFF</b>	The camera does not focus when the shutter button is pressed halfway.

## SHUTTER AE

If **ON** is selected, exposure will lock while the shutter button is pressed halfway.

Options	
<b>ON</b>	<b>OFF</b>



Select **OFF** to allow the camera to adjust exposure before each shot taken in burst mode.



## SHOOT WITHOUT LENS

Choose **ON** to enable the shutter release when no lens is attached.

Options	
<b>ON</b>	<b>OFF</b>

## FOCUS RING

Choose the direction in which the focus ring is rotated to increase the focus distance.

Options	
 <b>CW</b> (clockwise)	 <b>CCW</b> (counterclockwise)



## AE/AF-LOCK MODE

If **AE & AF ON WHEN PRESSING** is selected, exposure and/or focus will lock while the **AE-L** or **AF-L** button is pressed. If **AE & AF ON/OFF SWITCH** is selected, exposure and/or focus will lock when the **AE-L** or **AF-L** button is pressed and remain locked until the button is pressed again.

Options	
<b>AE &amp; AF ON WHEN PRESSING</b>	<b>AE &amp; AF ON/OFF SWITCH</b>

## APERTURE SETTING

Choose the method used to adjust aperture when using lenses with no aperture rings.

Option	Description
<b>AUTO +</b>  <b>MANUAL</b>	Rotate the front command dial to choose the aperture. Rotate past minimum aperture to choose <b>A</b> (auto).
<b>AUTO</b>	Aperture is selected automatically; camera functions in exposure mode <b>P</b> (program AE) or <b>S</b> (shutter-priority AE).
<b>MANUAL</b>	Rotate the front command dial to choose the aperture; camera functions in exposure mode <b>A</b> (aperture-priority AE) or <b>M</b> (manual).

**TOUCH SCREEN SETTING**

Enable or disable touch-screen controls.

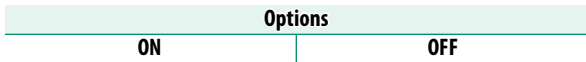



## POWER MANAGEMENT

Adjust power management settings.

To access power management settings, press **MENU/OK**, select the  (**SET UP**) tab, and choose **POWER MANAGEMENT**.

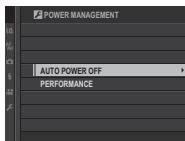

### AUTO POWER OFF

Choose the length of time before the camera turns off automatically when no operations are performed. Shorter times increase battery life; if **OFF** is selected, the camera must be turned off manually.

Options					
5 MIN	2 MIN	1 MIN	30 SEC	15 SEC	OFF

**PERFORMANCE**

Adjust power management settings.

Option	AF performance (speed)	LCD/EVF display quality	Battery endurance
<b>HIGH PERFORMANCE</b>	Fast	Very high	Low
<b>STANDARD</b>	Normal	High	Normal



When **STANDARD** is selected, the frame rate will drop when no operations are being performed. Operating camera controls returns the frame rate to normal.



## SAVE DATA SETTING

Make changes to file management settings.

To access file management settings, press **MENU/OK**, select the  (**SET UP**) tab, and choose **SAVE DATA SETTING**.

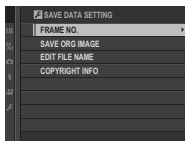

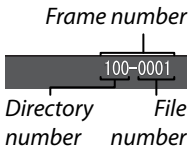

## FRAME NO.

New pictures are stored in image files named using a four-digit file number assigned by adding one to the last file number used. The file number is displayed during playback as shown. **FRAME NO.** controls whether file numbering is reset to 0001 when a new memory card is inserted or the current memory card is formatted.



Option	Description
<b>CONTINUOUS</b>	Numbering continues from the last file number used or the first available file number, whichever is higher. Choose this option to reduce the number of pictures with duplicate file names.
<b>RENEW</b>	Numbering is reset to 0001 after formatting or when a new memory card is inserted.

 If the frame number reaches 999-9999, the shutter release will be disabled. Format the memory card after transferring to a computer any pictures you wish to keep.

Selecting  **USER SETTING > RESET** sets **FRAME NO.** to **CONTINUOUS** but does not reset the file number.

Frame numbers for pictures taken with other cameras may differ.

**SAVE ORG IMAGE**

Choose **ON** to save unprocessed copies of pictures taken using **RED EYE REMOVAL**.

Options	
<b>ON</b>	<b>OFF</b>

**EDIT FILE NAME**

Change the file name prefix. sRGB images use a four-letter prefix (default “DSCF”), Adobe RGB images a three-letter prefix (“DSF”) preceded by an underscore.

Option	Default prefix	Sample file name
<b>sRGB</b>	DSCF	ABCD0001
<b>Adobe RGB</b>	_DSF	_ABC0001

## COPYRIGHT INFO

Copyright information, in the form of Exif tags, can be added to new images as they taken. Changes to copyright information are reflected only in images taken after the changes are made.

Option	Description
<b>DISP COPYRIGHT INFO</b>	View the current copyright information.
<b>ENTER AUTHOR'S INFO</b>	Enter the creator's name.
<b>ENTER COPYRIGHT INFO</b>	Enter the name of the copyright holder.
<b>DELETE COPYRIGHT INFO</b>	Delete the current copyright information. This change applies only to images taken after this option is selected; copyright information recorded with existing images is not affected.





## CONNECTION SETTING

Adjust settings for connection to other devices.

To access connection settings, press **MENU/OK**, select the  (**SET UP**) tab, and choose **CONNECTION SETTING**.

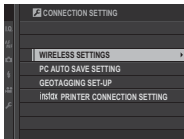

## WIRELESS SETTINGS

Adjust settings for connection to wireless networks.

Option	Description
<b>GENERAL SETTINGS</b>	Choose a name ( <b>NAME</b> ) to identify the camera on the wireless network (the camera is assigned a unique name by default) or select <b>RESET WIRELESS SETTINGS</b> to restore default settings.
<b>RESIZE IMAGE FOR SMARTPHONE </b>	Choose <b>ON</b> (the default setting, recommended in most circumstances) to resize larger images to <b>3M</b> for upload to smartphones, <b>OFF</b> to upload images at their original size. Resizing applies only to the copy uploaded to the smartphone; the original is not affected.
<b>PC AUTO SAVE SETTINGS</b>	Choose <b>DELETE REGISTERED DESTINATION PC</b> to remove selected destinations, <b>DETAILS OF PREVIOUS CONNECTION</b> to view computers to which the camera has recently connected.

## PC AUTO SAVE SETTING

Choose an upload destination. Choose **SIMPLE SETUP** to connect using WPS, **MANUAL SETUP** to configure network settings manually.

Options	
<b>SIMPLE SETUP</b>	<b>MANUAL SETUP</b>



For more information on wireless connections, visit:  
<http://fujifilm-dsc.com/wifi/>

## GEOTAGGING SET-UP

View location data downloaded from a smartphone and choose whether to save the data with your pictures.

Option	Description
<b>GEOTAGGING</b>	Choose whether location data downloaded from a smartphone are embedded in pictures as they are taken.
<b>LOCATION INFO</b>	Display the location data last downloaded from a smartphone.



For more information on wireless connections, visit:  
<http://fujifilm-dsc.com/wifi/>

**instax PRINTER CONNECTION SETTING**

Adjust settings for connection to optional FUJIFILM instax SHARE printers.

**The Printer Name (SSID) and Password**

The printer name (SSID) can be found on the bottom of the printer; the default password is "1111". If you have already chosen a different password to print from a smartphone, enter that password instead.

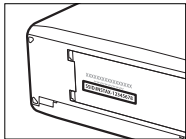



# Shortcuts

# 9

## Shortcut Options

---

Customize camera controls to suit your style or situation.

---

Frequently-used options can be added to the **Q** menu or a custom “my” menu or assigned to an **Fn** (function) button for direct access:

- **The Q menu** (📖 243): The **Q** menu is displayed by pressing the **Q** button. Use the **Q** menu to view or change the options selected for frequently-used menu items.
- **“My menu”** (📖 252): Add frequently-used options to this custom menu, which can be viewed by pressing **MENU/OK** and selecting the **MY** (“MY MENU”) tab.
- **The function buttons** (📖 248): Use the function buttons for direct access to selected features.

## The Q (Quick Menu) Button

Press **Q** for quick access to selected options.

### The Quick Menu Display

At default settings, the quick menu contains the following items:

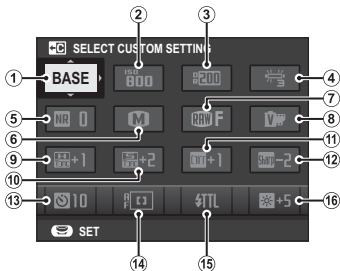

- |                         |                          |
|-------------------------|--------------------------|
| ① SELECT CUSTOM SETTING | ⑩ SHADOW TONE            |
| ② ISO                   | ⑪ COLOR                  |
| ③ DYNAMIC RANGE         | ⑫ SHARPNESS              |
| ④ WHITE BALANCE         | ⑬ SELF-TIMER             |
| ⑤ NOISE REDUCTION       | ⑭ AF MODE                |
| ⑥ IMAGE SIZE            | ⑮ FLASH FUNCTION SETTING |
| ⑦ IMAGE QUALITY         | ⑯ EVF/LCD BRIGHTNESS     |
| ⑧ FILM SIMULATION       |                          |
| ⑨ HIGHLIGHT TONE        |                          |

The quick menu shows the options currently selected for items (2)–(16), which can be changed as described on page 246.

### SELECT CUSTOM SETTING

The **IMAGE QUALITY SETTING > SELECT CUSTOM SETTING** item (item (1)) shows the current custom settings bank:

- **BASE**: No custom settings bank selected.
- **C1–C7**: Select a bank to view the settings saved using the **IMAGE QUALITY SETTING > EDIT/SAVE CUSTOM SETTING** option.
- ~~BASE~~ **C1–C7**: The current custom settings bank.



## Viewing and Changing Settings

- 1 Press **Q** to display the quick menu during shooting.

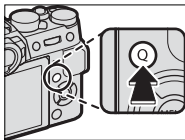

- 2 Use the selector to highlight items and rotate the rear command dial to change.



Changes are not saved to the current settings bank. Settings that differ from those in the current settings bank (**C1–C7**) are shown in red.

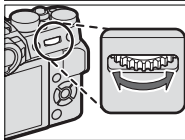

- 3 Press **Q** to exit when settings are complete.

## Editing the Quick Menu

To choose the items displayed in the quick menu:

- 1 Press and hold the **Q** button during shooting.

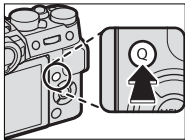

- 2 The current quick menu will be displayed; use the selector to highlight the item you wish to change and press **MENU/OK**.

### 3 Highlight any of the following options and press **MENU/OK** to assign it to the selected position.

- IMAGE SIZE
- IMAGE QUALITY
- FILM SIMULATION\*
- GRAIN EFFECT\*
- DYNAMIC RANGE\*
- WHITE BALANCE\*
- HIGHLIGHT TONE\*
- SHADOW TONE\*
- COLOR\*
- SHARPNESS\*
- NOISE REDUCTION\*
- SELECT CUSTOM SETTING\*
- AF MODE
- AF-C CUSTOM SETTINGS
- FACE/EYE DETECTION SETTING
- MF ASSIST
- SELF-TIMER
- PHOTOMETRY
- SHUTTER TYPE
- ISO
- TOUCH SCREEN MODE
- FLASH FUNCTION SETTING
- FLASH COMPENSATION
- MOVIE MODE
- MIC LEVEL ADJUSTMENT
- SOUND & FLASH
- EVF/LCD BRIGHTNESS
- EVF/LCD COLOR
- NONE

\* Stored in custom settings bank.



Select **NONE** to assign no option to the selected position. When **SELECT CUSTOM SETTING** is selected, current settings are shown in the quick menu by the label **BASE**.



The quick menu can also be edited using **Q BUTTON/DIAL SETTING > EDIT/SAVE QUICK MENU**.

## The Fn (Function) Buttons

The roles played by each of the function buttons can be selected by pressing and holding the button.

The default assignments are:

**Fn1 button**

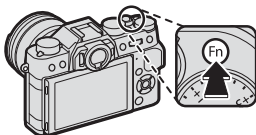

*Drive settings*

**Fn2 button**

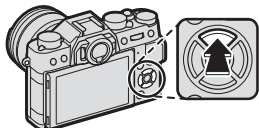

*AF mode*

**Fn3 button**

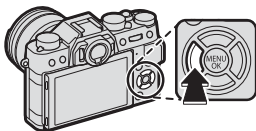

*Film simulation*

**Fn4 button**

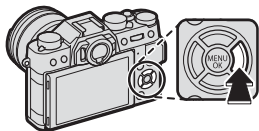

*Flash mode*

**Fn5 button**

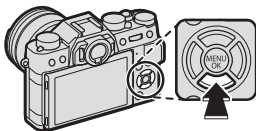

*Focus-frame selection*

**AE-L button**

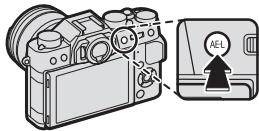

*Exposure lock*

**AF-L button**

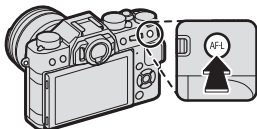

*Focus lock*

**Center of rear command dial**

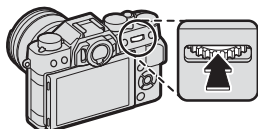

*Focus check*

## Assigning Roles to the Function Buttons

To assign roles to the buttons:

- 1 Press and hold the **DISP/BACK** button until a button selection menu is displayed.

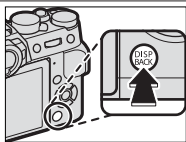

- 2 Highlight a button and press **MENU/OK**.
- 3 Highlight the desired role and press **MENU/OK** to assign it to the selected button. Choose from:

- IMAGE SIZE
- IMAGE QUALITY
- RAW
- FILM SIMULATION
- GRAIN EFFECT
- DYNAMIC RANGE
- WHITE BALANCE
- SELECT CUSTOM SETTING
- FOCUS AREA
- FOCUS CHECK
- AF MODE
- AF-C CUSTOM SETTINGS
- FACE/EYE DETECTION SETTING
- DRIVE SETTING
- SELF-TIMER
- PHOTOMETRY
- SHUTTER TYPE
- ISO
- WIRELESS COMMUNICATION
- FLASH FUNCTION SETTING
- TTL-LOCK
- MODELING FLASH
- MIC LEVEL ADJUSTMENT
- PREVIEW DEPTH OF FIELD
- PREVIEWEXP/WBINMANUALMODE
- PREVIEW PIC. EFFECT
- AE LOCK ONLY
- AF LOCK ONLY
- AE/AF LOCK
- AF-ON
- APERTURE SETTING
- PLAYBACK
- NONE (control disabled)



Button assignments can also be selected using **Fn/BUTTON/DIAL SETTING > Fn/AE-L/AF-L BUTTON SETTING**. The selector can not be assigned more than one role at a time.

## AF-ON

---

If **AF-ON** is selected, you can press the control instead of keeping the shutter button pressed halfway.

## MODELING FLASH

---

If **MODELING FLASH** is selected when a compatible shoe-mounted flash unit is attached, you can press the control to test-fire the flash and check for shadows and the like (modeling flash).

## TTL-LOCK

---

If **TTL-LOCK** is selected, you can press the control to lock flash output according to the option selected for **Fn/FLASH SETTING > TTL-LOCK MODE** (📖 166).

## MY MENU

Access a personalized menu of frequently-used options.

To display “my menu”, press **MENU/OK** in the shooting display and select the **MY** (MY MENU) tab.

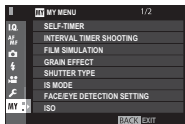

The **MY** tab is only available if options have been assigned to **MY MENU**.

## MY MENU SETTING

To choose the items listed in the **MY** (MY MENU) tab:

- 1 Highlight **USER SETTING** > **MY MENU SETTING** in the **SET UP** tab and press **MENU/OK** to display the options at right.
- 2 Press the selector up or down to highlight **MY MENU SETTING** and press **MENU/OK**. Options that can be added to “my menu” are highlighted in blue.

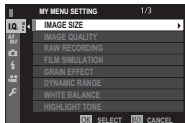
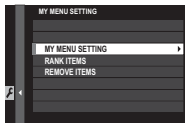

Items currently in “my menu” are indicated by check marks.



- 3 Highlight an item and press **MENU/OK** to add it to “my menu”.



- 4 Press **MENU/OK** to return to the edit display.
- 5 Repeat Steps 3 and 4 until all the desired items have been added.



“My menu” can contain up to 16 items.

#### Editing “My Menu”

To reorder or delete items, select **RANK ITEMS** or **REMOVE ITEMS** in Step 1.



# 10

## **Peripherals and Optional Accessories**

## External Flash Units

---

Flash units can be mounted on the hot shoe or connected via the sync terminal.

---

External flash units are more powerful than their built-in counterparts. Some support high-speed sync (FP) and can be used at shutter speeds faster than the sync speed, while others can function as master flash units controlling remote units via optical wireless flash control.



You may be unable to test-fire the flash in some circumstances, for example when a setup menu is displayed on the camera.



- 3 Highlight items using the selector and rotate the rear command dial to change the highlighted setting.

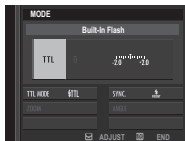

- 4 Press **DISP/BACK** to put the changes into effect.

### Red-Eye Removal

Red-eye removal is available when an option other than **OFF** is selected for **FLASH SETTING > RED EYE REMOVAL** and **AF/MF SETTING > FACE/EYE DETECTION SETTING** is **ON**. Red-eye removal minimizes “red-eye” caused when light from the flash is reflected from the subject’s retinas.

## SYNC TERMINAL

**SYNC TERMINAL** is displayed if the built-in flash is lowered and either no flash unit, or an incompatible flash unit, is mounted on the hot shoe.

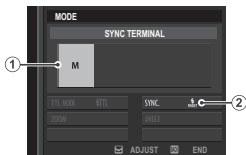

Setting	Description
① Flash control mode	<p>Choose from the following options:</p> <ul style="list-style-type: none"> <li>• <b>M</b>: A trigger signal is transmitted from the sync terminal and hot shoe when a picture is taken. Choose a shutter speed slower than the sync speed; even slower speeds may be required if the unit uses long flashes or has a slow response time.</li> <li>• <b>OFF</b>: The sync terminal and hot shoe do not transmit a trigger signal.</li> </ul>
② Sync	<p>Choose whether the flash is timed to fire immediately after the shutter opens (<b>FRONT/1ST CURTAIN</b>) or immediately before it closes (<b>REAR/2ND CURTAIN</b>). <b>1ST CURTAIN</b> is recommended in most circumstances.</p>

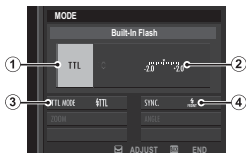

## BUILT-IN FLASH

The following options are available with the built-in flash.



Setting	Description
① Flash control mode	<p>Choose from the following options:</p> <ul style="list-style-type: none"><li>• <b>TTL</b>: TTL mode. Adjust flash compensation (②) and choose a flash mode (③).</li><li>• <b>M</b>: The flash fires at the selected output (②) regardless of subject brightness or camera settings. Output is expressed in fractions of full power, from <math>\frac{1}{4}</math> to <math>\frac{1}{64}</math>. The desired results may not be achieved at low values if they exceed the limits of the flash control system; take a test shot and check the results.</li><li>• <b>COMMANDER</b>: Choose if the flash is being used to control remote synced flash units, for example as part of a studio flash system.</li><li>• <b>OFF</b>: The flash does not fire.</li></ul>
② Flash compensation/output	Adjust flash level. The options available vary with the flash control mode (①).



Setting	Description
<p>③ Flash mode (TTL)</p>	<p>Choose a flash mode for TTL flash control. The options available vary with the shooting mode (<b>P</b>, <b>S</b>, <b>A</b>, or <b>M</b>) selected.</p> <ul style="list-style-type: none"> <li> <p><b>TTL (FLASH AUTO)</b>: The flash fires only as required; flash level is adjusted according to subject brightness. A  icon displayed when the shutter button is pressed halfway indicates that the flash will fire when the photo is taken.</p> </li> <li> <p><b>TTL (STANDARD)</b>: The flash fires with every shot if possible; flash level is adjusted according to subject brightness. The flash will not fire if not fully charged when the shutter is released.</p> </li> <li> <p><b>TTL SLOW (SLOW SYNC.)</b>: Combine the flash with slow shutter speeds when photographing portrait subjects against a backdrop of night scenery. The flash will not fire if not fully charged when the shutter is released.</p> </li> </ul>
<p>④ Sync</p>	<p>Choose whether the flash is timed to fire immediately after the shutter opens ( <b>FRONT</b> / <b>1ST CURTAIN</b>) or immediately before it closes ( <b>REAR</b> / <b>2ND CURTAIN</b>). <b>1ST CURTAIN</b> is recommended in most circumstances.</p>

## SHOE MOUNT FLASH

The following options are available with optional shoe-mounted flash units.



Setting	Description
① Flash control mode	<p>The flash control mode selected with the flash unit. This can in some cases be adjusted from the camera; the options available vary with the flash.</p> <ul style="list-style-type: none"><li>• <b>TTL:</b> TTL mode. Adjust flash compensation (②).</li><li>• <b>M:</b> The flash fires at the selected output regardless of subject brightness or camera settings. Output in some cases can be adjusted from the camera (②).</li><li>• <b>MULTI:</b> Repeating flash. Compatible shoe-mounted flash units will fire multiple times with each shot.</li><li>• <b>OFF:</b> The flash does not fire. Some flash units can be turned off from the camera.</li></ul>

Setting	Description
② Flash compensation/output	<p>The options available vary with flash control mode.</p> <ul style="list-style-type: none"> <li>• <b>TTL:</b> Adjust flash compensation (the full value may not be applied if the limits of the flash control system are exceeded). In the cases of the EF-X20, EF-20, and EF-42, the selected value is added to the value selected with the flash unit.</li> <li>• <b>M/MULTI:</b> Adjust flash output (compatible units only). Choose from values expressed as fractions of full power, from <math>\frac{1}{1}</math> (mode <b>M</b>) or <math>\frac{1}{4}</math> (<b>MULTI</b>) down to <math>\frac{1}{512}</math> in increments equivalent to <math>\frac{1}{3}</math> EV. The desired results may not be achieved at low values if they exceed the limits of the flash control system; take a test shot and check the results.</li> </ul>

Setting	Description
③ Flash mode (TTL)	<p>Choose a flash mode for TTL flash control. The options available vary with the shooting mode (<b>P</b>, <b>S</b>, <b>A</b>, or <b>M</b>) selected.</p> <ul style="list-style-type: none"><li>• <b>TTL (FLASH AUTO)</b>: The flash fires only as required; flash level is adjusted according to subject brightness. A  icon displayed when the shutter button is pressed halfway indicates that the flash will fire when the photo is taken.</li><li>• <b>TTL (STANDARD)</b>: The flash fires with every shot if possible; flash level is adjusted according to subject brightness. The flash will not fire if not fully charged when the shutter is released.</li><li>• <b>TTL SLOW (SLOW SYNC.)</b>: Combine the flash with slow shutter speeds when photographing portrait subjects against a backdrop of night scenery. The flash will not fire if not fully charged when the shutter is released.</li></ul>
④ Sync	<p>Control flash timing.</p> <ul style="list-style-type: none"><li>• <b>FRONT (1ST CURTAIN)</b>: The flash fires immediately after the shutter opens (generally the best choice).</li><li>• <b>REAR (2ND CURTAIN)</b>: The flash fires immediately before the shutter closes.</li><li>• <b>AUTO FP(HSS)</b>: High-speed sync (compatible units only). The camera automatically engages front-curtain high-speed sync at shutter speeds faster than the flash sync speed. Equivalent to <b>1ST CURTAIN</b> when <b>MULTI</b> is selected for flash control mode.</li></ul>

Setting	Description
⑤ Zoom	The angle of illumination (flash coverage) for units that support flash zoom. Some units allow the adjustment to be made from the camera. If <b>AUTO</b> is selected, zoom will automatically be adjusted to match coverage to lens focal length.
⑥ Lighting	If the unit supports this feature, choose from: <ul style="list-style-type: none"> <li>☞ (FLASH POWER PRIORITY): Gain range by slightly reducing coverage.</li> <li>☞ (STANDARD): Match coverage to picture angle.</li> <li>☞ (EVEN COVERAGE PRIORITY): Slightly increase coverage for more even lighting.</li> </ul>
⑦ LED light	Choose how the built-in LED light functions during still photography (compatible units only): as a catchlight (☞/CATCHLIGHT), as an AF-assist illuminator (AF/AF ASSIST), or as both a catchlight and an AF-ASSIST illuminator (☞/AF ASSIST+CATCHLIGHT). Choose <b>OFF</b> to disable the LED during photography.
⑦ Number of flashes*	Choose the number of times the flash fires each time the shutter is released in <b>MULTI</b> mode.
⑧ Frequency*	Choose the frequency at which the flash fires in <b>MULTI</b> mode.

\* Full value may not be applied if limits of flash control system are exceeded.

## MASTER(OPTICAL)

The options at right will be displayed if the unit is currently functioning as master flash for FUJIFILM optical wireless remote flash control.

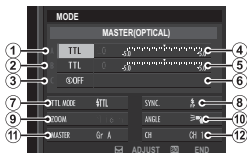



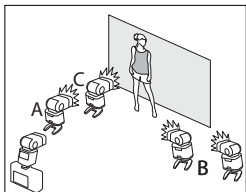

The master and remote units can be placed in up to three groups (A, B, and C) and flash mode and flash level adjusted separately for each group. Four channels are available for communication between







the units; separate channels can be used for different flash systems or to prevent interference when multiple systems are operating in close proximity.

Setting	Description
<p>① Flash control mode (group A)</p>	<p>Choose flash control modes for groups A, B, and C. <b>TTL%</b> is available for groups A and B only.</p> <ul style="list-style-type: none"> <li>• <b>TTL</b>: The units in the group fire in TTL mode. Flash compensation can be adjusted separately for each group.</li> <li>• <b>TTL%</b>: If <b>TTL%</b> is selected for either group A or B, you can specify the output of the selected group as a percentage of the other and adjust overall flash compensation for both groups.</li> </ul>
<p>② Flash control mode (group B)</p>	<ul style="list-style-type: none"> <li>• <b>M</b>: In mode <b>M</b>, the units in the group fire at the selected output (expressed as a fraction of full power) regardless of subject brightness or camera settings.</li> </ul>
<p>③ Flash control mode (group C)</p>	<ul style="list-style-type: none"> <li>• <b>MULTI</b>: Choosing <b>MULTI</b> for any group sets all the units in all groups to repeating flash mode. All units will fire multiple times with each shot.</li> <li>• <b>OFF</b>: If <b>OFF</b> is selected, the units in the group will not fire.</li> </ul>

Setting	Description	
④ Flash compensation/output (group A)	Adjust flash level for the selected group according to option selected for flash control mode. Note that the full value may not be applied if the limits of the flash control system are exceeded.	
⑤ Flash compensation/output (group B)		<ul style="list-style-type: none"> <li>• <b>TTL</b>: Adjust flash compensation.</li> <li>• <b>M/MULTI</b>: Adjust flash output.</li> </ul>
⑥ Flash compensation/output (group C)		<ul style="list-style-type: none"> <li>• <b>TTL%</b>: Choose the balance between groups A and B and adjust overall flash compensation.</li> </ul>
⑦ Flash mode (TTL)	<p>Choose a flash mode for TTL flash control. The options available vary with the shooting mode (<b>P</b>, <b>S</b>, <b>A</b>, or <b>M</b>) selected.</p> <ul style="list-style-type: none"> <li>• <b> (FLASH AUTO)</b>: The flash fires only as required; flash level is adjusted according to subject brightness. A  icon displayed when the shutter button is pressed halfway indicates that the flash will fire when the photo is taken.</li> <li>• <b> (STANDARD)</b>: The flash fires with every shot if possible; flash level is adjusted according to subject brightness. The flash will not fire if not fully charged when the shutter is released.</li> <li>• <b> (SLOW SYNC.)</b>: Combine the flash with slow shutter speeds when photographing portrait subjects against a backdrop of night scenery. The flash will not fire if not fully charged when the shutter is released.</li> </ul>	



Setting	Description
<p>⑧ Sync</p>	<p>Control flash timing.</p> <ul style="list-style-type: none"> <li>•  <b>(1ST CURTAIN)</b>: The flash fires immediately after the shutter opens (generally the best choice).</li> <li>•  <b>(2ND CURTAIN)</b>: The flash fires immediately before the shutter closes.</li> <li>• <b>AUTO FP(HSS)</b>: High-speed sync (compatible units only). The camera automatically engages front-curtain high-speed sync at shutter speeds faster than the flash sync speed. Equivalent to <b>1ST CURTAIN</b> when <b>MULTI</b> is selected for flash control mode.</li> </ul>
<p>⑨ Zoom</p>	<p>The angle of illumination (flash coverage) for units that support flash zoom. Some units allow the adjustment to be made from the camera. If <b>AUTO</b> is selected, zoom will automatically be adjusted to match coverage to lens focal length.</p>
<p>⑩ Lighting</p>	<p>If the unit supports this feature, choose from:</p> <ul style="list-style-type: none"> <li>•  <b>(FLASH POWER PRIORITY)</b>: Gain range by slightly reducing coverage.</li> <li>•  <b>(STANDARD)</b>: Match coverage to picture angle.</li> <li>•  <b>(EVEN COVERAGE PRIORITY)</b>: Slightly increase coverage for more even lighting.</li> </ul>

Setting	Description
⑪ Master	Assign the master flash to group A ( <b>Gr A</b> ), B ( <b>Gr B</b> ), or C ( <b>Gr C</b> ). If <b>OFF</b> is selected, output from the master flash will be held to a level that does not affect the final picture. Available only if the unit is mounted on the camera hot shoe as a master flash for FUJIFILM optical wireless remote flash control in <b>TTL</b> , <b>TTL%</b> , or <b>M</b> mode.
⑪ Number of flashes	Choose the number of times the flash fires each time the shutter is released in <b>MULTI</b> mode.
⑫ Channel	Choose the channel used by the master flash for communication with the remote flash units. Separate channels can be used for different flash systems or to prevent interference when multiple systems are operating in close proximity.
⑫ Frequency	Choose the frequency at which the flash fires in <b>MULTI</b> mode.

## Lenses

The camera can be used with lenses for the FUJIFILM X-mount.

### Lens Parts

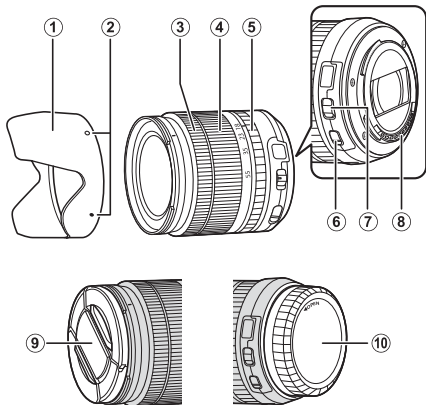

- ① Lens hood
- ② Mounting marks
- ③ Focus ring
- ④ Zoom ring
- ⑤ Aperture ring
- ⑥ O.I.S. switch
- ⑦ Aperture mode switch
- ⑧ Lens signal contacts
- ⑨ Front lens cap
- ⑩ Rear lens cap

## Removing Lens Caps

Remove lens caps as shown.

 Lens caps may differ from those shown.

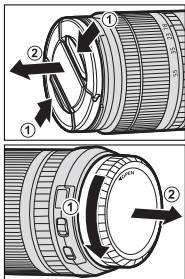

## Attaching Lens Hoods

When attached, lens hoods reduce glare and protect the front lens element.

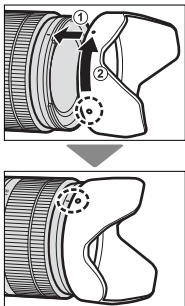

## Lenses with Aperture Rings

At settings other than **A**, you can adjust aperture by rotating the lens aperture ring (exposure modes **A** and **M**).

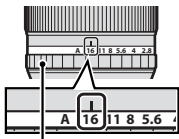

*Aperture ring*

- When the aperture ring is set to **A**, rotate the front command dial to adjust aperture.

### The Aperture Mode Switch

If the lens has an aperture mode switch, aperture can be adjusted manually by sliding the switch to  and rotating the aperture ring.

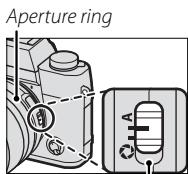

*Aperture mode switch*

## Lenses with No Aperture Rings

The method used to adjust aperture can be selected using **FUNCTION/DIAL SETTING > APERTURE SETTING**. When an option other than **AUTO** is selected, aperture can be adjusted using the front command dial.

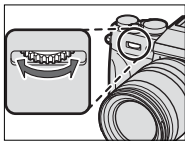

**FUNCTION/DIAL SETTING > COMMAND DIAL SETTING**. Aperture control defaults to the front command dial, but can be reassigned to the rear command dial using **FUNCTION/DIAL SETTING > COMMAND DIAL SETTING**.

## Lenses with O.I.S. Switches

If the lens supports optical image stabilization (O.I.S.), the image stabilization mode can be chosen in the camera menus. To activate image stabilization, slide the O.I.S. switch to **ON**.

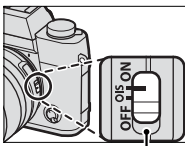

O.I.S. switch

## Manual Focus Lenses

Slide the focus ring to the front for autofocus.

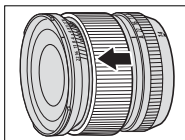

For manual focus, slide the focus ring to the back and rotate it while checking the results in the camera display. The focus distance and depth-of-field indicators can be used to assist manual focus.

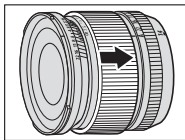

### The Depth-of-Field Indicator

The depth-of-field indicator shows the approximate depth of field (the distance in front of and behind the focus point that appears to be in focus). The indicator is displayed in film format.



**!** Note that manual focus may not be available in all shooting modes.

## Lens Care

Use a blower to remove dust, then gently wipe with a soft, dry cloth. Any remaining stains can be removed by wiping gently with a piece of FUJIFILM lens-cleaning paper to which a small amount of lens-cleaning fluid has been applied. Replace the front and rear caps when the lens is not in use.



# 11 Connections

## HDMI Output

Camera shooting and playback displays can be output to HDMI devices.

### Connecting to HDMI Devices

Connect the camera to TVs or other HDMI devices using a third-party HDMI cable.

- 1 Turn the camera off.
- 2 Connect the cable as shown below, making sure the connectors are fully inserted.

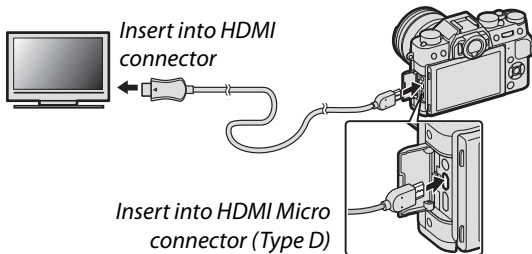

**!** Use an HDMI cable no more than 1.5 m (4.9 ft.) long.

- 3 Configure the device for HDMI input as described in the documentation supplied with the device.

- 4 Turn the camera on. You can now shoot and play back pictures while viewing the television display and save pictures to the HDMI device.



The USB cable can not be used while an HDMI cable is connected.

## Shooting

Shoot photos and record movies while viewing the scene through the camera lens on or saving footage to the HDMI device.



This feature can be used to save 4K and Full HD movies to an HDMI recorder.

## Playback

To start playback, press the camera  button. The camera monitor turns off and pictures and movies are output to the HDMI device. Note that the camera volume controls have no effect on sounds played on the TV; use the television volume controls to adjust the volume.



Some televisions may briefly display a black screen when movie playback begins.

## Wireless Transfer

Access wireless networks and connect to computers, smartphones, or tablets.

For downloads and other information, visit:

<http://fujifilm-dsc.com/wifi/>

fujifilm Wi-Fi app



## Wireless Connections: Smartphones

Install the “FUJIFILM Camera Remote” app on your smartphone to browse the images on the camera, download selected images, control the camera remotely, or copy location data to the camera. Once the app is installed, connect using the **SHOOTING SETTING > WIRELESS COMMUNICATION** or **PLAY BACK MENU > WIRELESS COMMUNICATION** options in the camera menus.



## Wireless Connections: Computers

Once you have installed the “FUJIFILM PC AutoSave” application and configured your computer as a destination for the images copied from the camera, you can upload pictures from the camera using **PLAY BACK MENU > PC AUTO SAVE**.

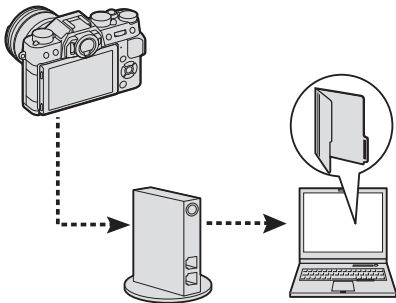

## Connecting to Computers via USB

Copy pictures to a computer via USB.

### Windows

Use MyFinePix Studio to copy pictures to your computer, where they can be stored, viewed, organized, and printed. MyFinePix Studio is available for download from the following website:

*<http://fujifilm-dsc.com/mfs/>*



Once download is complete, double-click the downloaded file ("MFPS\_Setup.EXE") and follow the on-screen instructions to complete installation.

 You may need the Windows CD when starting the software for the first time.

## Mac OS X/macOS

Pictures can be copied to your computer using Image Capture (supplied with your computer) or other software.

### Viewing RAW Files

To view RAW files on your computer, use RAW FILE CONVERTER EX 2.0, available for download from:

<http://fujifilm-dsc.com/rfc/>



## Connecting the Camera

- 1 Find a memory card containing pictures you want to copy to the computer and insert the card into the camera.



Loss of power during transfer could result in loss of data or damage to the memory card. Insert a fresh or fully-charged battery before connecting the camera.

- 2 Ready a third-party USB 2.0 cable with a Micro USB (Micro-B) connector. Turn the camera off and connect the cable, making sure the connectors are fully inserted.

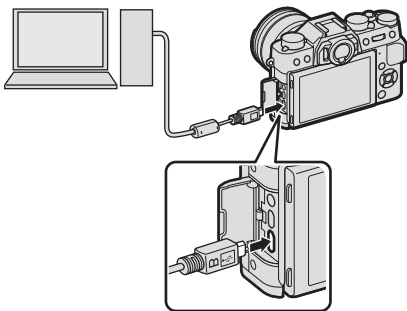

- 3 Turn the camera on.
- 4 Copy pictures to the computer using MyFinePix Studio or applications provided with your operating system.
- 5 When transfer is complete, turn the camera off and disconnect the USB cable.





If a memory card containing a large number of images is inserted, there may be a delay before the software starts and you may be unable to import or save images. Use a memory card reader to transfer pictures.

The USB cable must be no more than 1.5 m (4.9 ft.) long and be suitable for data transfer. Connect the camera directly to the computer; do not use a USB hub or keyboard.

Make sure that the computer does not display a message stating that copying is in progress and that the indicator lamp is out before turning the camera off or disconnecting the USB cable (if the number of images copied is very large, the indicator lamp may remain lit after the message has cleared from the computer display). Failure to observe this precaution could result in loss of data or damage to the memory card.

Disconnect the camera before inserting or removing memory cards.

In some cases, it may not be possible to access pictures saved to a network server using the software in the same way as on a standalone computer.

The user bears all applicable fees charged by the phone company or Internet service provider when using services that require an Internet connection.

## instax SHARE Printers

Print pictures from your digital camera to instax SHARE printers.

### Establishing a Connection

Select **CONNECTION SETTING** > **instax PRINTER CONNECTION SETTING** and enter the instax SHARE printer name (SSID) and password.

#### The Printer Name (SSID) and Password

The printer name (SSID) can be found on the bottom of the printer; the default password is "1111". If you have already chosen a different password to print from a smartphone, enter that password instead.

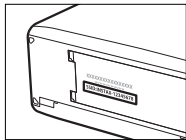

## Printing Pictures

- 1 Turn the printer on.
- 2 Select  **PLAY BACK MENU** > **instax PRINTER PRINT**. The camera will connect to the printer.



 To print a frame from a burst sequence, display the frame before selecting **instax PRINTER PRINT**.

- 3 Use the selector to display the picture you want to print, then press **MENU/OK**.



 Pictures taken with other cameras can not be printed.  
The area printed is smaller than the area visible in the LCD monitor.

- 4 The picture will be sent to the printer and printing will start.



# 12

## Technical Notes

## Accessories from FUJIFILM

The following optional accessories are available from FUJIFILM. For the latest information on the accessories available in your region, check with your local FUJIFILM representative or visit [http://www.fujifilm.com/products/digital\\_cameras/index.html](http://www.fujifilm.com/products/digital_cameras/index.html).

### Rechargeable Li-ion batteries

**NP-W126/NP-W126S:** Additional high-capacity NP-W126/NP-W126S rechargeable batteries can be purchased as required.



### Battery chargers

**BC-W126:** Replacement battery chargers can be purchased as required. At +20°C/+68°F, the BC-W126 charges an NP-W126/NP-W126S in about 150 minutes.



### AC power adapters

**AC-9V** (requires CP-W126 DC coupler): Use this 100–240 V, 50/60 Hz AC power adapter for extended shooting and playback or when copying pictures to a computer.

### DC couplers

**CP-W126:** Connect the AC-9V to the camera.

### Remote releases

**RR-90:** Use to reduce camera shake or keep the shutter open during a time exposure.



**Stereo microphones**

**MIC-ST1:** An external microphone for movie recording.

**FUJINON lenses**

**XF-series lenses:** Interchangeable lenses for use exclusively with the FUJIFILM X-mount.



**XC-series lenses:** Interchangeable lenses for use exclusively with the FUJIFILM X-mount.

**Shoe-mounted flash units**

**EF-X500:** This clip-on flash unit has a Guide Number of 50/164 (ISO 100, m/ft.) and supports FP (high-speed sync), allowing it to be used at shutter speeds that exceed the flash sync speed. Powered by four AA batteries or an optional BF-BP1 battery pack, it supports manual and TTL flash control and auto power zoom in the range 24–105 mm (35 mm format equivalent) and features FUJIFILM optical wireless flash control, allowing it to be used as a master or remote flash unit for remote wireless flash photography. The flash head can be rotated 90° up, 10° down, 135° left, or 180° right for bounce lighting.



### Shoe-mounted flash units (continued)

**EF-42:** This clip-on flash unit (powered by four AA batteries) has a Guide Number of 42/137 (ISO 100, m/ft.) and supports manual and TTL flash control and auto power zoom in the range 24–105 mm (35 mm format equivalent). The flash head can be rotated 90° up, 180° left, or 120° right for bounce lighting.



**EF-X20:** This clip-on flash unit has a Guide Number of 20/65 (ISO 100, m/ft.). Powered by two AAA batteries, this light, compact unit features a dial for adjusting TTL flash compensation or manual flash output.



**EF-20:** This clip-on flash unit (powered by two AA batteries) has a Guide Number of 20/65 (ISO 100, m/ft.) and supports TTL flash control (manual flash control is not supported). The flash head can be rotated upwards 90° for bounce lighting.



### Hand grips

**MHG-XT10:** Features an improved grip. Batteries and memory cards can be removed with the grip in place, and the grip is equipped with a rail for quick-shoe camera mounts.

### Leather cases

**BLC-XT10:** This case combines practicality with the luxury of leather and comes with a cloth that can be used to wrap the camera before putting it in the case and on other occasions. Pictures can be taken and batteries inserted or removed with the camera still in its case.



**Grip belts**

**GB-001:** Improves grip. Combine with a hand grip for more secure handling.

**Macro extension tubes**

**MCEX-11/16:** Attach between the camera and the lens to shoot at high reproduction ratios.

**Teleconverters**

**XF1.4X TC WR:** Increases the focal length of the compatible lenses by about 1.4x.

**XF2X TC WR:** Increases the focal length of the compatible lenses by about 2.0x.

**Mount adapters**

**FUJIFILM M MOUNT ADAPTER:** Allows the camera to be used with a wide selection of M-mount lenses.

**Body caps**

**BCP-001:** Cover the camera lens mount when no lens is attached.

**instax SHARE printers**

**SP-1/SP-2:** Connect via wireless LAN to print pictures on instax film.

# For Your Safety

## IMPORTANT SAFETY INSTRUCTIONS

- **Read Instructions:** All the safety and operating instructions should be read before the appliance is operated.
- **Retain Instructions:** The safety and operating instructions should be retained for future reference.
- **Heed Warnings:** All warnings on the appliance and in the operating instructions should be adhered to.
- **Follow Instructions:** All operating and use instructions should be followed.

### Installation

**Power Sources:** This video product should be operated only from the type of power source indicated on the marking label. If you are not sure of the type of power supply to your home, consult your appliance dealer or local power company. For video products intended to operate from battery power, or other sources, refer to the operating instructions.

**Grounding or Polarization:** This video product is equipped with a polarized alternating-current line plug (a plug having one blade wider than the other). This plug will fit into the power outlet only one way. This is a safety feature. If you are unable to insert the plug fully into the outlet, try reversing the plug. If the plug should still fail to fit, contact your electrician to replace your obsolete outlet. Do not defeat the safety purpose of the polarized plug.

**Alternate Warnings:** This video product is equipped with a three-wire grounding-type plug, a plug having a third (grounding) pin. This plug will only fit into a grounding-type power outlet. This is a safety feature. If you are unable to insert the plug into the outlet, contact your electrician to replace your obsolete outlet. Do not defeat the safety purpose of the grounding type plug.

**Overloading:** Do not overload wall outlets and extension cords as this can result in a risk of fire or electric shock.

**Ventilation:** Slots and openings in the cabinet are provided for ventilation, to ensure reliable operation of the video product and to protect it from overheating, and these openings must not be blocked or covered. The openings should never be blocked by placing the video product on a bed, sofa, rug, or other similar surface.

This video product should not be placed in a built-in installation such as a bookcase or rack unless proper ventilation is provided or the manufacturer's instructions have been adhered to. This video product should never be placed near or over a radiator or heat register.

**Attachments:** Do not use attachments not recommended by the video product manufacturer as they may cause hazards.

**Water and Moisture:** Do not use this video product near water—for example, near a bath tub, wash bowl, kitchen sink, or laundry tub, in a wet basement, or near a swimming pool, and the like.

**Power-Cord Protection:** Power-supply cords should be routed so that they are not likely to be walked on or pinched by items placed upon or against them, paying particular attention to cords at plugs, convenience receptacles, and the point where they exit from the appliance.

**Accessories:** Do not place this video product on an unstable cart, stand, tripod, bracket, or table. The video product may fall, causing serious injury to a child or adult, and serious damage to the appliance. Use only with a cart, stand, tripod, bracket, or table recommended by the manufacturer, or sold with the video product. Any mounting of the appliance should follow the manufacturer's instructions, and should use a mounting accessory recommended by the manufacturer.

An appliance and cart combination should be moved with care. Quick stops, excessive force, and uneven surfaces may cause the appliance and cart combination to overturn.



### Antennas

**Outdoor Antenna Grounding:** If an outside antenna or cable system is connected to the video product, be sure the antenna or cable system is grounded so as to provide some protection against voltage surges and built-up static charges. Section 810 of the National Electrical Code, ANSI/NFPA No. 70, provides information with respect to proper grounding of the mast and supporting structure, grounding of the lead-in wire to an antenna discharge unit, size of grounding conductors, location of antenna discharge unit, connection to grounding electrodes, and requirements for the grounding electrode.

#### EXAMPLE OF ANTENNA GROUNDING AS PER NATIONAL ELECTRICAL CODE

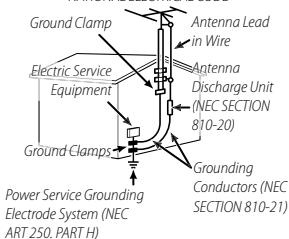

**Power Lines:** An outside antenna system should not be located in the vicinity of overhead power lines or other electric light or power circuits, or where it can fall into such power lines or circuits. When installing an outside antenna system, extreme care should be taken to keep from touching such power lines or circuits as contact with them might be fatal.

### Use

**Cleaning:** Unplug this video product from the wall outlet before cleaning. Do not use liquid cleaners or aerosol cleaners. Use a damp cloth for cleaning.

**Object and Liquid Entry:** Never push objects of any kind into this video product through openings as they may touch dangerous voltage points or short out parts that could result in a fire or electric shock. Never spill liquid of any kind on the video product.

**Lightning:** For added protection for this video product receiver during a lightning storm, or when it is left unattended and unused for long periods of time, unplug it from the wall outlet and disconnect the antenna or cable system. This will prevent damage to the video product due to lightning and power-line surges.

### Service

**Servicing:** Do not attempt to service this video product yourself as opening or removing covers may expose you to dangerous voltage or other hazards. Refer all servicing to qualified service personnel.

**Damage Requiring Service:** Unplug this video product from the wall outlet and refer servicing to qualified service personnel under the following conditions:

- When the power-supply cord or plug is damaged
- If liquid has been spilled, or objects have fallen into the video product.
- If the video product has been exposed to rain or water.
- If the video product has been dropped or the cabinet has been damaged.

If the video product does not operate normally follow the operating instructions. Adjust only those controls that are covered by the operating instructions as an improper adjustment of other controls may result in damage and will often require extensive work by a qualified technician to restore the video product to its normal operation. When the video product exhibits a distinct change in performance — this indicates a need for service.

**Replacement Parts:** When replacement parts are required, be sure the service technician has used replacement parts specified by the manufacturer or have the same characteristics as the original part. Unauthorized substitutions may result in fire, electric shock or other hazards.

**Safety Check:** Upon completion of any service or repairs to this video product, ask the service technician to perform safety checks to determine that the video product is in proper operating condition.



## Be sure to read these notes before use

### Safety Notes



- Make sure that you use your camera correctly. Read these safety notes and your *Owner's Manual* carefully before use.
- After reading these safety notes, store them in a safe place.

### About the Icons



The icons shown below are used in this document to indicate the severity of the injury or damage that can result if the information indicated by the icon is ignored and the product is used incorrectly as a result.

	<b>WARNING</b> This icon indicates that death or serious injury can result if the information is ignored.
	<b>CAUTION</b> This icon indicates that personal injury or material damage can result if the information is ignored.

The icons shown below are used to indicate the nature of the instructions which are to be observed.

	Triangular icons tell you that this information requires attention ("Important").
	Circular icons with a diagonal bar tell you that the action indicated is prohibited ("Prohibited").
	Filled circles with an exclamation mark indicate an action that must be performed ("Required").

The symbols on the product (including the accessories) represent the following:

	AC
	DC
	Class II equipment (The construction of the product is double-insulated.)









### WARNING









**If a problem arises, turn the camera off, remove the battery, and disconnect and unplug the AC power adapter.** Continued use of the camera when it is emitting smoke, is emitting any unusual odor, or is in any other abnormal state can cause a fire or electric shock. Contact your FUJIFILM dealer.

**Do not allow water or foreign objects to enter the camera.** If water or foreign objects get inside the camera, turn the camera off, remove the battery, and disconnect and unplug the AC power adapter. Continued use of the camera can cause a fire or electric shock. Contact your FUJIFILM dealer.

**Do not use the camera in the bathroom or shower.** This can cause a fire or electric shock.

**Never attempt to change or take apart the camera (never open the case).** Failure to observe this precaution can cause fire or electric shock.

 <b>WARNING</b>	
 <small>Do not touch internal parts</small>	<b><u>Should the case break open as the result of a fall or other accident, do not touch the exposed parts.</u></b> Failure to observe this precaution could result in electric shock or in injury from touching the damaged parts. Remove the battery immediately, taking care to avoid injury or electric shock, and take the product to the point of purchase for consultation.
	<b><u>Do not change, heat or unduly twist or pull the connection cord and do not place heavy objects on the connection cord.</u></b> These actions could damage the cord and cause a fire or electric shock. If the cord is damaged, contact your FUJIFILM dealer.
	<b><u>Do not place the camera on an unstable surface.</u></b> This can cause the camera to fall or tip over and cause injury.
	<b><u>Never attempt to take pictures while in motion.</u></b>
	Do not use the camera while walking or driving. This can result in you falling down or being involved in a traffic accident.
	<b><u>Do not touch any metal parts of the camera during a thunderstorm.</u></b> This can cause an electric shock due to induced current from the lightning discharge.
	<b><u>Do not use the battery except as specified.</u></b> Load the battery as shown by the indicator.
	<b><u>Do not disassemble, modify, or heat batteries. Do not drop, strike, or throw batteries or otherwise subject them to strong impacts. Do not use batteries that show signs of leaking, deformation, discoloration, or other abnormalities. Use only designated chargers to recharge rechargeable batteries and do not attempt to recharge non-rechargeable Li-ion or alkaline batteries. Do not short batteries or store them with metallic objects.</u></b> Failure to observe these precautions could result in the batteries overheating, igniting, rupturing, or leaking, causing fire, burns, or other injury.

 <b>WARNING</b>	
	<b><u>Use only batteries or AC power adapters specified for use with this camera. Do not use voltages other than the power supply voltage shown.</u></b> The use of other power sources can cause a fire.
	<b><u>If the battery leaks and fluid gets in contact with your eyes, skin or clothing, flush the affected area with clean water and seek medical attention or call an emergency number right away.</u></b>
	<b><u>Do not use the charger to charge batteries other than those specified here.</u></b> The supplied charger is for use only with batteries of the type supplied with the camera. Using the charger to charge conventional batteries or other types of rechargeable batteries can cause the battery to leak, overheat or burst.
	<b><u>Using a flash too close to a person's eyes may cause visual impairment.</u></b> Take particular care when photographing infants and young children.
	<b><u>Do not remain in prolonged contact with hot surfaces.</u></b> Failure to observe this precaution could result in low-temperature burns, particularly at high ambient temperatures or with users who suffer from poor circulation or reduced sensation, in which case use of a tripod or similar precautions are recommended.
	<b><u>Do not leave one part of the body in contact with the product for prolonged periods while the product is on.</u></b> Failure to observe this precaution could result in low-temperature burns, particularly during prolonged use, at high ambient temperatures, or with users who suffer from poor circulation or reduced sensation, in which case use of a tripod or similar precautions are recommended.
	<b><u>Do not use in the presence of flammable objects, explosive gases, or dust.</u></b>

 **WARNING**

***When carrying the battery, install it in a digital camera or keep it in the hard case. When storing the battery, keep it in the hard case.***



***When discarding, cover the battery terminals with insulation tape.*** Contact with other metallic objects or batteries could cause the battery to ignite or burst.

***Keep memory cards, hot shoes, and other small parts out of the reach of small children.***



Children may swallow small parts; keep out of reach of children. Should a child swallow a small part, seek medical attention or call emergency.

***Keep out of reach of small children.*** Among the elements that could cause injury are the strap, which could become entangled about a child's neck, causing strangulation, and the flash, which could cause visual impairment.



***Follow the directions of airline and hospital personnel.*** This product generates radio-frequency emissions that could interfere with navigational or medical equipment.



 **CAUTION**



***Do not cover or wrap the camera or the AC power adapter in a cloth or blanket.*** This can cause heat to build up and distort the casing or cause a fire.



***When you are cleaning the camera or you do not plan to use the camera for an extended period, remove the battery and disconnect and unplug the AC power adapter.*** Failure to do so can cause a fire or electric shock.



***When charging ends, unplug the charger from the power socket.*** Leaving the charger plugged into the power socket can cause a fire.



***When a memory card is removed, the card could come out of the slot too quickly. Use your finger to hold it and gently release the card.*** Injury could result to those struck by the ejected card.



***Request regular internal testing and cleaning for your camera.*** Build-up of dust in your camera can cause a fire or electric shock. Contact your FUJIFILM dealer to request internal cleaning every two years. Please note that this service is not free of charge.



***Danger of explosion if battery is incorrectly replaced. Replace only with the same or equivalent type.***

 **CAUTION**



***Do not use this camera in locations affected by oil fumes, steam, humidity or dust.*** This can cause a fire or electric shock.



***Do not leave this camera in places subject to extremely high temperatures.*** Do not leave the camera in locations such as a sealed vehicle or in direct sunlight. This can cause a fire.



***Do not place heavy objects on the camera.*** This can cause the heavy object to tip over or fall and cause injury.



***Do not move the camera while the AC power adapter is still connected.*** Do not pull on the connection cord to disconnect the AC power adapter. This can damage the power cord or cables and cause a fire or electric shock.

## The Battery and Power Supply

**Note:** Check the type of battery used in your camera and read the appropriate sections.

The following describes the proper use of batteries and how to prolong their life. Incorrect use can shorten battery life or cause leakage, overheating, fire, or explosion.

### **Li-ion Batteries**

*Read this section if your camera uses a rechargeable Li-ion battery.*

The battery is not charged at shipment. Charge the battery before use. Keep the battery in its case when not in use.

#### **■ Notes on the Battery**

The battery gradually loses its charge when not in use. Charge the battery one or two days before use.

Battery life can be extended by turning the camera off when not in use.

Battery capacity decreases at low temperatures; a depleted battery may not function when cold. Keep a fully charged spare battery in a warm place and exchange as necessary, or keep the battery in your pocket or other warm place and insert it in the camera only when shooting. Do not place the battery in direct contact with hand warmers or other heating devices.

#### **■ Charging the Battery**

Charge the battery in the supplied battery charger. Charging times will increase at ambient temperatures below +10°C (+50°F) or above +35°C (+95°F). Do not attempt to charge the battery at temperatures above 40°C (+104°F); at temperatures below 0°C (+32°F), the battery will not charge.

Do not attempt to recharge a fully charged battery. The battery does not however need to be fully discharged before charging.

The battery may be warm to the touch immediately after charging or use. This is normal.

#### **■ Battery Life**

At normal temperatures, the battery can be recharged about 300 times. A noticeable decrease in the length of time the battery will hold a charge indicates that it has reached the end of its service life and should be replaced.

#### **■ Storage**

Performance may be impaired if the battery is left unused for extended periods when fully charged. Run the battery flat before storing it.

If the camera will not be used for an extended period, remove the battery and store it in a dry place with an ambient temperature of from +15°C to +25°C (+59°F to +77°F). Do not store in locations exposed to extremes of temperature.

#### **■ Cautions: Handling the Battery**

- Do not transport or store with metal objects such as necklaces or hairpins.
- Do not expose to flame or heat.
- Do not disassemble or modify.
- Use with designated chargers only.
- Dispose of used batteries promptly.
- Do not drop or subject to strong physical shocks.
- Do not expose to water.
- Keep the terminals clean.
- The battery and camera body may become warm to the touch after extended use. This is normal.

#### **■ Disposal**

Dispose of used batteries in accord with local regulations.

#### **AC Power Adapters (Available Separately)**

Use only FUJIFILM AC power adapters designated for use with this camera. Other adapters could damage the camera.

- The AC power adapter is for indoor use only.
- Be sure the DC plug is securely connected to the camera.
- Turn the camera off before disconnecting the adapter. Disconnect the adapter by the plug, not the cable.
- Do not use with other devices.
- Do not disassemble.
- Do not expose to high heat and humidity.
- Do not subject to strong physical shocks.
- The adapter may hum or become hot to the touch during use. This is normal.
- If the adapter causes radio interference, reorient or relocate the receiving antenna.

### **Using the Camera**

- Do not aim the camera at extremely bright light sources, such as the sun in a cloudless sky. Failure to observe this precaution could damage the camera image sensor.
- Strong sunlight focused through the viewfinder may damage the panel of electronic viewfinder (EVF). Do not aim the electronic viewfinder at the sun.

#### **Take Test Shots**

Before taking photographs on important occasions (such as at weddings or before taking the camera on a trip), take a test shot and view the results to ensure that the camera is functioning normally. FUJIFILM Corporation can not accept liability for damages or lost profits incurred as a result of product malfunction.

#### **Notes on Copyright**

Unless intended solely for personal use, images recorded using your digital camera system cannot be used in ways that infringe copyright laws without the consent of the owner. Note that some restrictions apply to the photographing of stage performances, entertainments, and exhibits, even when intended purely for personal use. Users are also asked to note that the transfer of memory cards containing images or data protected under copyright laws is only permissible within the restrictions imposed by those copyright laws.

#### **Handling**

To ensure that images are recorded correctly, do not subject the camera to impact or physical shocks while images are being recorded.

#### **Liquid Crystal**

In the event that the display is damaged, care should be taken to avoid contact with liquid crystal. Take the urgent action indicated should any of the following situations arise:

- **If liquid crystal comes in contact with your skin**, clean the area with a cloth and then wash thoroughly with soap and running water.
- **If liquid crystal enters your eyes**, flush the affected eye with clean water for at least 15 minutes and then seek medical assistance.
- **If liquid crystal is swallowed**, rinse your mouth thoroughly with water. Drink large quantities of water and induce vomiting, then seek medical assistance.

Although the display is manufactured using extremely high-precision technology, it may contain pixels that are always lit or that do not light. This is not a malfunction, and images recorded with the product are unaffected.



**Trademark Information**

Digital Split Image is a trademark or registered trademark of FUJIFILM Corporation. xD-Picture Card and  are trademarks of FUJIFILM Corporation. The typefaces included herein are solely developed by DynaComware Taiwan Inc. Macintosh, Mac OS, and macOS are trademarks of Apple Inc. in the U.S.A. and other countries. Windows is a registered trademark of Microsoft Corporation in the U.S.A. and other countries. Wi-Fi® and Wi-Fi Protected Setup® are registered trademarks of the Wi-Fi Alliance. The SDHC and SDXC logos are trademarks of SD-3C, LLC. The HDMI logo is a trademark. All other trade names mentioned in this manual are the trademarks or registered trademarks of their respective owners.

**Electrical Interference**

This camera may interfere with hospital or aviation equipment. Consult with hospital or airline staff before using the camera in a hospital or on an aircraft.

**Color Television Systems**

NTSC (National Television System Committee) is a color television telecasting specification adopted mainly in the U.S.A., Canada, and Japan. PAL (Phase Alternation by Line) is a color television system adopted mainly in European countries and China.

**Exif Print (Exif Version 2.3)**

Exif Print is a newly revised digital camera file format in which information stored with photographs is used for optimal color reproduction during printing.

**IMPORTANT NOTICE: Read Before Using the Software**

Direct or indirect export, in whole or in part, of licensed software without the permission of the applicable governing bodies is prohibited.

**NOTICES**

*To prevent fire or shock hazard, do not expose the unit to rain or moisture.*

*Please read the "Safety Notes" and make sure you understand them before using the camera.*

*Perchlorate Material—special handling may apply. See:*

*<http://www.dtsc.ca.gov/hazardouswaste/perchlorate>*

*For Customers in the U. S. A.*

### Tested To Comply With FCC Standards

#### FOR HOME OR OFFICE USE



Contains IC : 7736B-02000003

Contains FCC ID : W2Z-02000003

**FCC Statement:** This device complies with Part 15 of the FCC Rules. Operation is subject to the following two conditions: (1) This device may not cause harmful interference, and (2) this device must accept any interference received, including interference that may cause undesired operation.

**CAUTION:** This equipment has been tested and found to comply with the limits for a Class B digital device, pursuant to Part 15 of the FCC Rules. These limits are designed to provide reasonable protection against harmful interference in a residential installation. This equipment generates, uses, and can radiate radio frequency energy and, if not installed and used in accordance with the instructions, may cause harmful interference to radio communications. However, there is no guarantee that interference will not occur in a particular installation. If this equipment does cause harmful interference to radio or television reception, which can be determined by turning the equipment off and on, the user is encouraged to try to correct the interference by one or more of the following measures:

- Reorient or relocate the receiving antenna.
- Increase the separation between the equipment and receiver.
- Connect the equipment into an outlet on a circuit different from that to which the receiver is connected.
- Consult the dealer or an experienced radio/TV technician for help.

**FCC Caution:** Any changes or modifications not expressly approved by the party responsible for compliance could void the user's authority to operate this equipment.

This transmitter must not be co-located or operating in conjunction with any other antenna or transmitter.

**Radiation Exposure Statement:** This device meets the government's requirements for exposure to radio waves. This device is designed and manufactured not to exceed the emission limits for exposure to radio frequency (RF) energy set by the Federal Communications Commission of the U.S. Government.

The exposure standard for wireless device employs a unit of measurement known as the Specific Absorption Rate, or SAR. The SAR limit set by the FCC is 1.6W/kg. Tests for SAR are conducted using standard operating positions accepted by the FCC with the device transmitting at its highest certified power level in all tested frequency bands.

**Notes on the Grant:** To comply with Part 15 of the FCC Rules, this product must be used with a Fujifilm-specified ferrite-core A/V cable, USB cable, and DC supply cord.



A lithium ion battery that is recyclable powers the product you have purchased. Please call 1-800-8-BATTERY for information on how to recycle this battery.

*For Customers in Canada*

#### CAN ICES-3 (B)/NMB-3(B)

**CAUTION:** This Class B digital apparatus complies with Canadian ICES-003.

**Industry Canada statement:** This device complies with Industry Canada's licence-exempt RSSs. Operation is subject to the following two conditions: (1) This device may not cause interference; and (2) This device must accept any interference, including interference that may cause undesired operation of the device.

This device and its antenna(s) must not be co-located or operating in conjunction with any other antenna or transmitter, except tested built-in radios. The County Code Selection feature is disabled for products marketed in the US/ Canada.

**Radiation Exposure Statement:** The available scientific evidence does not show that any health problems are associated with using low power wireless devices. There is no proof, however, that these low power wireless devices are absolutely safe. Low power Wireless devices emit low levels of radio frequency energy (RF) in the microwave range while being used. Whereas high levels of RF can produce health effects (by heating tissue), exposure of low-level RF that does not produce heating effects causes no known adverse health effects. Many studies of low-level RF exposures have not found any biological effects. Some studies have suggested that some biological effects might occur, but such findings have not been confirmed by additional research. X-T20 has been tested and found to comply with IC radiation exposure limits set forth for an uncontrolled environment and meets RSS-102 of the IC radio frequency (RF) Exposure rules.

#### *Disposal of Electrical and Electronic Equipment in Private Households*

**In the European Union, Norway, Iceland and Liechtenstein:** This symbol on the product, or in the manual and in the warranty, and/or on its packaging indicates that this product shall not be treated as household waste. Instead it should be taken to an applicable collection point for the recycling of electrical and electronic equipment.

By ensuring this product is disposed of correctly, you will help prevent potential negative consequences to the environment and human health, which could otherwise be caused by inappropriate waste handling of this product.

This symbol on the batteries or accumulators indicates that those batteries shall not be treated as household waste.



If your equipment contains easy removable batteries or accumulators please dispose these separately according to your local requirements.

The recycling of materials will help to conserve natural resources. For more detailed information about recycling this product, please contact your local city office, your household waste disposal service or the shop where you purchased the product.

**In Countries Outside the European Union, Norway, Iceland and Liechtenstein:** If you wish to discard this product, including the batteries or accumulators, please contact your local authorities and ask for the correct way of disposal.

**In Japan:** This symbol on the batteries indicates that they are to be disposed of separately.



Li-ion



## Be sure to read these notes before use

### Safety Notes

- Make sure that you use the lens correctly. Read these safety notes and the camera *Owner's Manual* carefully before use.
- After reading these safety notes, store them in a safe place.

### About the Icons

The icons shown below are used in this document to indicate the severity of the injury or damage that can result if the information indicated by the icon is ignored and the product is used incorrectly as a result.



#### WARNING

This icon indicates that death or serious injury can result if the information is ignored.



#### CAUTION

This icon indicates that personal injury or material damage can result if the information is ignored.

The icons shown below are used to indicate the nature of the instructions which are to be observed.



Triangular icons tell you that this information requires attention ("Important").



Circular icons with a diagonal bar tell you that the action indicated is prohibited ("Prohibited").



Filled circles with an exclamation mark indicate an action that must be performed ("Required").



#### WARNING



Do not immerse

**Do not immerse in or expose to water.** Failure to observe this precaution can cause a fire or electric shock.



Do not disassemble

**Do not disassemble (do not open the case).** Failure to observe this precaution can cause fire, electric shock, or injury due to product malfunction.



#### WARNING



Do not touch internal parts

**Should the case break open as the result of a fall or other accident, do not touch the exposed parts.** Failure to observe this precaution could result in electric shock or in injury from touching the damaged parts. Remove the battery immediately, taking care to avoid injury or electric shock, and take the product to the point of purchase for consultation.



**Do not place on unstable surfaces.** The product may fall, causing injury.



**Do not view the sun through the lens or camera viewfinders.** Failure to observe this precaution can cause permanent visual impairment.



#### CAUTION



**Do not use or store in locations that are exposed to steam, or smoke or are very humid or extremely dusty.** Failure to observe this precaution can cause fire or electric shock.



**Do not leave in direct sunlight or in locations subject to very high temperatures, such as in a closed vehicle on a sunny day.** Failure to observe this precaution can cause fire.



**Keep out of the reach of small children.** This product could cause injury in the hands of a child.



**Do not handle with wet hands.** Failure to observe this precaution can cause electric shock.



**Keep the sun out of the frame when shooting backlit subjects.** Sunlight focused into the camera when the sun is in or close to the frame can cause fire or burns.



**When the product is not in use, replace the lens caps and store out of direct sunlight.** Sunlight focused by the lens can cause fire or burns.



**Do not carry the camera or lens while they are attached to a tripod.** The product can fall or strike other objects, causing injury.

**European Union Regulatory Notice**

This product complies with the following EU Directives:

- RoHS Directive 2011/65/EU
- R & TTE Directive 1999/5/EC

Compliance with these directives implies conformity to applicable harmonized European standards (European Norms) which are listed on the EU Declaration of Conformity issued by FUJIFILM Corporation for this product or product family.

This compliance is indicated by the following conformity marking placed on the product:



This marking is valid for non-Telecom products and EU harmonized Telecom products (e.g. Bluetooth).

Regarding the Declaration of Conformity, visit [http://www.fujifilm.com/products/digital\\_cameras/x/fujifilm\\_x\\_t20/pdf/index/fujifilm\\_x\\_t20\\_cod.pdf](http://www.fujifilm.com/products/digital_cameras/x/fujifilm_x_t20/pdf/index/fujifilm_x_t20_cod.pdf).

**IMPORTANT:** Read the following notices before using the camera's built-in wireless transmitter.

- Ⓢ This product, which contains encryption function developed in the United States, is controlled by the United States Export Administration Regulations and may not be exported or re-exported to any country to which the United States embargoes goods.
- **Use only as part of a wireless network.** FUJIFILM does not accept liability for damages resulting from unauthorized use. Do not use in applications requiring a high degree of reliability, for example in medical devices or other systems that may directly or indirectly impact human life. When using the device in computer and other systems that demand a greater degree of reliability than wireless networks, be sure to take all necessary precautions to ensure safety and prevent malfunction.

- **Use only in the country in which the device was purchased.** This device conforms to regulations governing wireless network devices in the country in which it was purchased. Observe all location regulations when using the device. FUJIFILM does not accept liability for problems arising from use in other jurisdictions.
- **Wireless data (images) may be intercepted by third parties.** The security of data transmitted over wireless networks is not guaranteed.
- **Do not use the device in locations subject to magnetic fields, static electricity, or radio interference.** Do not use the transmitter in the vicinity of microwave ovens or in other locations subject to magnetic fields, static electricity, or radio interference that may prevent reception of wireless signals. Mutual interference may occur when the transmitter is used in the vicinity of other wireless devices operating in the 2.4 GHz band.
- **The wireless transmitter operates in the 2.4 GHz band using DSSS and OFDM modulation.**

**Wireless Network Devices: Cautions**

- **This device operates on the same frequency as commercial, educational, and medical devices and wireless transmitters.** It also operates on the same frequency as licensed transmitters and special unlicensed low-voltage transmitters used in RFID tracking systems for assembly lines and in other similar applications.
- **To prevent interference with the above devices, observe the following precautions.** Confirm that the RFID transmitter is not in operation before using this device. Should you observe that the device causes interference in licensed transmitters used for RFID tracking, immediately stop using the affected frequency or move the device to another location. If you notice that this device causes interference in low-voltage RFID tracing systems, contact a FUJIFILM representative.

**2.4DS/OF4**  

This sticker indicates that this device operates in the 2.4 GHz band using DSSS and OFDM modulation and may cause interference at distances of up to 40 m.

## Product Care

---

To ensure continued enjoyment of the product, observe the following precautions.

---

**Camera body:** Use a soft, dry cloth to clean the camera body after each use. Do not use alcohol, thinner, or other volatile chemicals, which could discolor or deform the leather on the camera body. Any liquid on the camera should be removed immediately with a soft, dry cloth. Use a blower to remove dust from the monitor, taking care to avoid scratches, and then gently wipe with a soft, dry cloth. Any remaining stains can be removed by wiping gently with a piece of FUJIFILM lens-cleaning paper to which a small amount of lens-cleaning fluid has been applied. To prevent dust entering the camera, replace the body cap when no lens is in place.

**Image sensor:** Multiple photographs marred by spots or blotches in identical locations may indicate the presence of dust on the image sensor. Clean the sensor using  **USER SETTING > SENSOR CLEANING.**

## Cleaning the Image Sensor

Dust that can not be removed using **USER SETTING > SENSOR CLEANING** can be removed manually as described below.

**!** Note that there will be a charge to repair or replace the image sensor if it is damaged during cleaning.

- 1 Use a blower (not a brush) to remove dust from the sensor.

**!** Do not use a brush or blower brush. Failure to observe this precaution could damage the sensor.

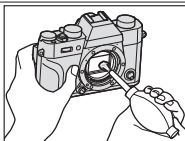

- 2 Check whether the dust has been successfully removed. Repeat Steps 1 and 2 as necessary.
- 3 Replace the body cap or lens.



## Firmware Updates

Updates to product firmware may result in changes not described in the manual. For more information, visit:

*[http://www.fujifilm.com/support/digital\\_cameras/software](http://www.fujifilm.com/support/digital_cameras/software)*



### Checking the Firmware Version

 The camera will only display the firmware version if a memory card is inserted.

- 1 Turn the camera off and check that a memory card is inserted.
- 2 Turn the camera on while pressing the **DISP/BACK** button. The current firmware version will be displayed; check the firmware version.
- 3 Turn the camera off.

 If a lens is attached to the camera, you can also check the lens firmware version.

## Troubleshooting

Consult the table below should you encounter problems using your camera. If you don't find the solution here, contact your local FUJIFILM distributor.

### Power and Battery

Problem	Solution
The camera does not turn on.	<ul style="list-style-type: none"><li>• <b>The battery is exhausted:</b> Charge the battery or insert a fully-charged spare battery (📖 32).</li><li>• <b>The battery is inserted incorrectly:</b> Reinsert in the correct orientation (📖 37).</li><li>• <b>The battery-chamber cover is not latched:</b> Latch the battery-chamber cover (📖 38).</li></ul>
The monitor does not turn on.	The monitor may not turn on if the camera is turned off and then on again very quickly. Press the shutter button halfway to activate the monitor.
The battery runs down quickly.	<ul style="list-style-type: none"><li>• <b>The battery is cold:</b> Warm the battery by placing it in a pocket or other warm place and reinsert it in the camera immediately before taking a picture.</li><li>• <b>There is dirt on the battery terminals:</b> Clean the terminals with a soft, dry cloth.</li><li>• <b>ON is selected for  AF/MF SETTING &gt; PRE-AF:</b> Turn PRE-AF off (📖 137).</li><li>• <b>The battery has been charged many times:</b> The battery has reached the end of its charging life. Purchase a new battery.</li></ul>

Problem	Solution
The camera turns off suddenly.	<b>The battery is exhausted:</b> Charge the battery or insert a fully-charged spare battery (📖 32).
Charging does not start.	Reinsert the battery in the correct orientation and make sure that the charger is plugged in (📖 32).
Charging is slow.	Charge the battery at room temperature.
The charging lamp blinks, but the battery does not charge.	<ul style="list-style-type: none"> <li>• <b>There is dirt on the battery terminals:</b> Clean the terminals with a soft, dry cloth.</li> <li>• <b>The battery has been charged many times:</b> The battery has reached the end of its charging life. Purchase a new battery. If the battery still fails to charge, contact your FUJIFILM dealer (📖 290).</li> </ul>

## Menus and Displays

Problem	Solution
Display is not in English.	Select <b>ENGLISH</b> for <b>USER SETTING</b> > <b>言語/LANG.</b> (📖 46, 204).

## Shooting

Problem	Solution
No picture is taken when the shutter button is pressed.	<ul style="list-style-type: none"> <li>• <b>The memory card is full:</b> Insert a new memory card or delete pictures (📖 36, 183).</li> <li>• <b>The memory card is not formatted:</b> Format the memory card (📖 201).</li> <li>• <b>There is dirt on the memory card contacts:</b> Clean the contacts with a soft, dry cloth.</li> </ul>

Problem	Solution
<p>No picture is taken when the shutter button is pressed (continued).</p>	<ul style="list-style-type: none"> <li>• <b>The memory card is damaged:</b> Insert a new memory card (📖 36).</li> <li>• <b>The battery is exhausted:</b> Charge the battery or insert a fully-charged spare battery (📖 32).</li> <li>• <b>The camera has turned off automatically:</b> Turn the camera on (📖 42).</li> <li>• <b>You are using a third-party mount adapter:</b> Select <b>ON</b> for <b>SHOOT WITHOUT LENS</b> (📖 228).</li> <li>• <b>The indicator lamp was orange when you attempted to record a panorama:</b> Wait until the indicator lamps turns off (📖 10).</li> </ul>
<p>Mottling (“noise”) appears in the monitor or viewfinder when the shutter button is pressed halfway.</p>	<p>Gain is increased to aid composition when the subject is poorly lit and aperture is stopped down, which may result in noticeable mottling when images are previewed in the displays. Images taken with the camera are unaffected.</p>
<p>The camera does not focus.</p>	<p><b>The subject is not suited to autofocus:</b> Use focus lock or manual focus (📖 92).</p>

Problem	Solution
<p><b>No face is detected.</b></p>	<ul style="list-style-type: none"> <li>• <b>The subject's face is obscured by sunglasses, a hat, long hair, or other objects:</b> Remove the obstructions (📖 138).</li> <li>• <b>The subject's face occupies only a small area of the frame:</b> Change the composition so that the subject's face occupies a larger area of the frame (📖 138).</li> <li>• <b>The subject's head is tilted or horizontal:</b> Ask the subject to hold their head straight (📖 138).</li> <li>• <b>The camera is tilted:</b> Keep the camera level.</li> <li>• <b>The subject's face is poorly lit:</b> Shoot in bright light.</li> </ul>
<p><b>Wrong subject is selected.</b></p>	<p>The selected subject is closer to the center of the frame than the main subject. Recompose the picture or turn face detection off and frame the picture using focus lock (📖 92).</p>
<p><b>The flash does not fire.</b></p>	<ul style="list-style-type: none"> <li>• <b>The flash is disabled:</b> Adjust settings (📖 107).</li> <li>• <b>The flash is lowered:</b> Raise the flash (📖 107).</li> <li>• <b>The battery is exhausted:</b> Charge the battery or insert a fully-charged spare battery (📖 32).</li> <li>• <b>The camera is in bracketing or continuous mode:</b> Select single frame mode (📖 6).</li> <li>• <b>OFF is selected for SOUND &amp; FLASH:</b> Select <b>ON</b> (📖 206).</li> </ul>

Problem	Solution
The flash does not fully light the subject.	<ul style="list-style-type: none"> <li>• <b>The subject is not in range of the flash:</b> Position the subject in range of the flash.</li> <li>• <b>The flash window is obstructed:</b> Hold the camera correctly.</li> <li>• <b>Shutter speed is faster than the sync speed:</b> Choose a slower shutter speed (📖 64, 72).</li> </ul>
Some flash modes are not available.	<p><b>OFF is selected for SOUND &amp; FLASH:</b> Select <b>ON</b> (📖 206).</p>
Pictures are blurred.	<ul style="list-style-type: none"> <li>• <b>The lens is dirty:</b> Clean the lens (📖 276).</li> <li>• <b>The lens is blocked:</b> Keep objects away from the lens (📖 49).</li> <li>• <b>!AF is displayed during shooting and the focus frame is displayed in red:</b> Check focus before shooting (📖 50).</li> </ul>
Pictures are mottled.	<ul style="list-style-type: none"> <li>• <b>Shutter speed is slow and the ambient temperature is high:</b> This is normal and does not indicate a malfunction.</li> <li>• <b>Pixel mapping is required:</b> Perform pixel mapping using <b>📷 IMAGE QUALITY SETTING &gt; PIXEL MAPPING</b> (📖 130).</li> <li>• <b>The camera has been used continuously at high temperatures or a temperature warning is displayed:</b> Turn the camera off and wait for it to cool down (📖 42).</li> </ul>

## Playback

Problem	Solution
<b>Pictures are grainy.</b>	The pictures were taken with a different make or model of camera.
<b>Playback zoom is unavailable.</b>	The pictures were created using <b>RESIZE</b> or with a different make or model of camera.
<b>No sound in movie playback.</b>	<ul style="list-style-type: none"> <li>• <b>Playback volume is too low:</b> Adjust playback volume (📖 211).</li> <li>• <b>The microphone was obstructed:</b> Hold the camera correctly during recording.</li> <li>• <b>The speaker is obstructed:</b> Hold the camera correctly during playback.</li> <li>• <b>OFF is selected for SOUND &amp; FLASH:</b> Select <b>ON</b> (📖 206).</li> </ul>
<b>Selected pictures are not deleted.</b>	Some of the pictures selected for deletion are protected. Remove protection using the device with which it was originally applied (📖 188).
<b>File numbering is unexpectedly reset.</b>	The battery-chamber cover was opened while the camera was on. Turn the camera off before opening the battery-chamber cover (📖 234).

## Connections

Problem	Solution
The monitor is blank.	<b>The camera is connected to a TV:</b> Pictures will be displayed on the TV instead of in the camera monitor (📖 278).
No picture or sound on TV.	<ul style="list-style-type: none"><li>• <b>The camera is not properly connected:</b> Connect the camera properly (📖 278).</li><li>• <b>Input on the television is set to “TV”:</b> Set input to “HDMI” (📖 278).</li><li>• <b>The volume on the TV is too low:</b> Use the controls on the television to adjust the volume.</li></ul>
Both the TV and camera monitor are blank.	<b>The display mode selected with the VIEW MODE button is EVF ONLY +  SENSOR:</b> Put your eye to the viewfinder or use the <b>VIEW MODE</b> button to choose another display mode.
The computer does not recognize the camera.	Be sure the camera and computer are correctly connected (📖 282).
Can not transfer RAW or JPEG files to computer.	Use MyFinePix Studio to transfer pictures (Windows only; 📖 282).



## Wireless Transfer

For additional information on troubleshooting wireless connections, visit: <http://digital-cameras.support.fujifilm.com/app?pid=x>



Problem	Solution
<b>Problem connecting or uploading pictures to smartphone.</b>	<ul style="list-style-type: none"> <li>• <b>The smartphone is too far away:</b> Move the devices closer (📖 280).</li> <li>• <b>Nearby devices are causing radio interference:</b> Move the camera and smartphone away from microwave ovens or cordless phones (📖 280).</li> </ul>
<b>Can not upload images.</b>	<ul style="list-style-type: none"> <li>• <b>The smartphone is connected to another device:</b> The smartphone and camera can connect to only one device at a time. End the connection and try again (📖 280).</li> <li>• <b>There are several smartphones in the vicinity:</b> Try connecting again. The presence of multiple smartphones can make connection difficult (📖 280).</li> <li>• The current image is a movie or was created on another device and can not be uploaded to a smartphone (📖 280).</li> </ul>
<b>Smartphone will not display pictures.</b>	<p>Select <b>ON</b> for <b>📷 CONNECTION SETTING &gt; WIRELESS SETTING &gt; RESIZE IMAGE FOR SMARTPHONE 3M</b>. Selecting <b>OFF</b> increases upload times for larger images; in addition, some phones may not display images over a certain size (📖 237).</p>

## Miscellaneous

Problem	Solution
<p>The camera is unresponsive.</p>	<ul style="list-style-type: none"> <li>• <b>Temporary camera malfunction:</b> Remove and reinsert the battery (📖 36).</li> <li>• <b>The battery is exhausted:</b> Charge the battery or insert a fully-charged spare battery (📖 32).</li> <li>• <b>The camera is connected to a wireless LAN:</b> End the connection.</li> </ul>
<p>The camera does not function as expected.</p>	<p>Remove and reinsert the battery (📖 36). If the problem persists, contact your FUJIFILM dealer.</p>
<p>No sound.</p>	<ul style="list-style-type: none"> <li>• Adjust the volume (📖 208).</li> <li>• <b>OFF is selected for SOUND &amp; FLASH:</b> Select <b>ON</b> (📖 206).</li> </ul>
<p>Pressing the Q button does not display the quick menu.</p>	<p><b>TTL-LOCK is active:</b> End TTL-LOCK (📖 251).</p>







## Warning Messages and Displays

The following warnings appear in the display.

Warning	Description
 (red)	Low battery. Charge the battery or insert a fully-charged spare battery.
 (blinks red)	Battery exhausted. Charge the battery or insert a fully-charged spare battery.
<b>!AF</b> (displayed in red with red focus frame)	The camera can not focus. Use focus lock to focus on another subject at the same distance, then re-compose the picture.
Aperture or shutter speed displayed in red	The subject is too bright or too dark and the picture will be over- or under-exposed. Use the flash for additional lighting when taking photographs of poorly-lit subject.
<b>FOCUS ERROR LENS CONTROL ERROR TURN OFF THE CAMERA AND TURN ON AGAIN</b>	Camera malfunction. Turn the camera off and then on again. If the message persists, contact a FUJIFILM dealer.
<b>NO CARD</b>	The shutter can only be released when a memory card is inserted. Insert a memory card.
<b>CARD NOT INITIALIZED</b>	<ul style="list-style-type: none"><li>• <b>The memory card is not formatted or the memory card has been formatted in a computer or other device:</b> Format the memory card using  <b>USER SETTING &gt; FORMAT.</b></li></ul>





Warning	Description
<b>CARD NOT INITIALIZED</b> (continued)	<ul style="list-style-type: none"> <li>• <b>The memory card contacts require cleaning:</b> Clean the contacts with a soft, dry cloth. If the message is repeated, format the card. If the message persists, replace the card.</li> <li>• <b>Camera malfunction:</b> Contact a FUJIFILM dealer.</li> </ul>
<b>LENS ERROR</b>	Turn the camera off, remove the lens, and clean the mounting surfaces, then replace the lens and turn the camera on. If the problem persists, contact a FUJIFILM dealer.
<b>CARD ERROR</b>	<ul style="list-style-type: none"> <li>• <b>The memory card is not formatted for use in the camera:</b> Format the card.</li> <li>• <b>The memory card contacts require cleaning or the memory card is damaged:</b> Clean the contacts with a soft, dry cloth. If the message is repeated, format the card. If the message persists, replace the card.</li> <li>• <b>Incompatible memory card:</b> Use a compatible card.</li> <li>• <b>Camera malfunction:</b> Contact a FUJIFILM dealer.</li> </ul>
<b>PROTECTED CARD</b>	The memory card is locked. Unlock the card.
<b>BUSY</b>	The memory card is incorrectly formatted. Use the camera to format the card.
 <b>MEMORY FULL</b>	The memory card is full and pictures can not be recorded. Delete pictures or insert a memory card with more free space.
<b>WRITE ERROR</b>	<ul style="list-style-type: none"> <li>• <b>Memory card error or connection error:</b> Reinsert the card or turn the camera off and then on again. If the message persists, contact a FUJIFILM dealer.</li> </ul>

Warning	Description
<b>WRITE ERROR</b> (continued)	<ul style="list-style-type: none"> <li>• <b>Not enough memory remaining to record additional pictures:</b> Delete pictures or insert a memory card with more free space.</li> <li>• <b>The memory card is not formatted:</b> Format the memory card.</li> </ul>
<b>FRAME NO. FULL</b>	<p>The camera has run out of frame numbers (current frame number is 999-9999). Insert a formatted memory card and select <b>RENEW</b> for  <b>SAVE DATA SETTING &gt; FRAME NO.</b> Take a picture to reset frame numbering to 100-0001, then select <b>CONTINUOUS</b> for <b>FRAME NO.</b></p>
<b>READ ERROR</b>	<ul style="list-style-type: none"> <li>• <b>The file is corrupt or was not created with the camera:</b> The file can not be viewed.</li> <li>• <b>The memory card contacts require cleaning:</b> Clean the contacts with a soft, dry cloth. If the message is repeated, format the card. If the message persists, replace the card.</li> <li>• <b>Camera malfunction:</b> Contact a FUJIFILM dealer.</li> </ul>
<b>PROTECTED FRAME</b>	<p>An attempt was made to delete or rotate to a protected picture. Remove protection and try again.</p>
<b>CAN NOT CROP</b>	<p>The picture is damaged or was not created with the camera.</p>
<b>DPOF FILE ERROR</b>	<p>Print orders can contain no more than 999 pictures. Copy any additional pictures you wish to print to another memory card and create a second print order.</p>
<b>CAN NOT ROTATE</b>	<p>The selected picture can not be rotated.</p>

Warning	Description
 <b>CAN NOT ROTATE</b>	Movies can not be rotated.
<b>CAN NOT SET DPOF</b>	The picture can not be printed using DPOF.
 <b>CAN NOT SET DPOF</b>	Movies can not be printed using DPOF.
 <b>CANNOT EXECUTE</b>	Red-eye removal can not be applied to movies.
 <b>CANNOT EXECUTE</b>	Red-eye removal can not be applied to pictures created with other devices.
<b>MISMATCH: 4K MODE AND EXTERNAL MONITOR CHANGE MOVIE MODE</b>	The movie mode selected with the camera is not compatible with the device to which the camera is connected via HDMI. Try selecting a different movie mode.
 (yellow)	Turn the camera off and wait for it to cool. Mottling may increase in pictures taken when this warning is displayed.
 (red)	Turn the camera off and wait for it to cool. While this warning is displayed, movies can not be recorded, mottling may increase, and performance, including frame advance rate and display quality, may drop.

## Memory Card Capacity

The following table shows the recording time or number of pictures available at different image sizes. All figures are approximate; file size varies with the scene recorded, producing wide variations in the number of files that can be stored. The number of exposures or length remaining may not diminish at an even rate.

		Capacity	8 GB		16 GB	
			FINE	NORMAL	FINE	NORMAL
Photos	 <b>L 3:2</b>		540	800	1110	1660
	<b>RAW (UNCOMPRESSED)</b>		150		320	
	<b>RAW (LOSSLESS COMPRESSED)</b>		310		640	
Movies <sup>1</sup>	 <b>2160/29.97P, 25P, 24P, 23.98P<sup>2</sup></b>		9 minutes		20 minutes	
	 <b>1080/59.94P, 50P, 29.97P, 25P, 24P, 23.98P<sup>3</sup></b>		26 minutes		52 minutes	
	 <b>720/59.94P, 50P, 29.97P, 25P, 24P, 23.98P<sup>4</sup></b>		51 minutes		103 minutes	

1 Use a UHS speed class 3 card or better.

2 Individual movies can not exceed 10 minutes in length, or 30 minutes if filmed using a power booster grip.

3 Individual movies can not exceed 15 minutes in length, or 30 minutes if filmed using a power booster grip.

4 Individual movies can not exceed 30 minutes in length.

 Although movie recording will continue without interruption when the file size reaches 4GB, subsequent footage will be recorded to a separate file which must be viewed separately.

## Specifications

### System

<b>Model</b>	FUJIFILM X-T20									
<b>Product Number</b>	FF160006									
<b>Effective pixels</b>	Approx. 24.3 million									
<b>Image sensor</b>	23.5 mm × 15.6 mm (APS-C), X-Trans CMOS III sensor with primary color filter									
<b>Storage media</b>	FUJIFILM-recommended SD/SDHC/SDXC memory cards									
<b>Memory card slot</b>	SD memory card slot									
<b>File system</b>	Compliant with Design Rule for Camera File System (DCF), Exif 2.3, and Digital Print Order Format (DPOF)									
<b>File format</b>	<ul style="list-style-type: none"><li>• <b>Still pictures:</b> Exif 2.3 JPEG (compressed); RAW (original RAF format, uncompressed or compressed using a lossless algorithm; special purpose software required); RAW+JPEG available</li><li>• <b>Movies:</b> H.264 standard with stereo sound (MOV)</li></ul>									
<b>Image size</b>	<table><tr><td><b>L 3:2</b> (6000×4000)</td><td><b>L 16:9</b> (6000×3376)</td><td><b>L 1:1</b> (4000×4000)</td></tr><tr><td><b>M 3:2</b> (4240×2832)</td><td><b>M 16:9</b> (4240×2384)</td><td><b>M 1:1</b> (2832×2832)</td></tr><tr><td><b>S 3:2</b> (3008×2000)</td><td><b>S 16:9</b> (3008×1688)</td><td><b>S 1:1</b> (2000×2000)</td></tr></table> <p><b>RAW</b> (6000 × 4000)</p> <p><b>L panorama:</b> vertical (2160 × 9600)/horizontal (9600 × 1440)</p> <p><b>M panorama:</b> vertical (2160 × 6400)/horizontal (6400 × 1440)</p>	<b>L 3:2</b> (6000×4000)	<b>L 16:9</b> (6000×3376)	<b>L 1:1</b> (4000×4000)	<b>M 3:2</b> (4240×2832)	<b>M 16:9</b> (4240×2384)	<b>M 1:1</b> (2832×2832)	<b>S 3:2</b> (3008×2000)	<b>S 16:9</b> (3008×1688)	<b>S 1:1</b> (2000×2000)
<b>L 3:2</b> (6000×4000)	<b>L 16:9</b> (6000×3376)	<b>L 1:1</b> (4000×4000)								
<b>M 3:2</b> (4240×2832)	<b>M 16:9</b> (4240×2384)	<b>M 1:1</b> (2832×2832)								
<b>S 3:2</b> (3008×2000)	<b>S 16:9</b> (3008×1688)	<b>S 1:1</b> (2000×2000)								
<b>Lens mount</b>	FUJIFILM X mount									



## System

- Sensitivity**
- **Still pictures:** Standard output sensitivity equivalent to ISO 200–12800 in increments of  $\frac{1}{3}$  EV; AUTO; extended output sensitivity equivalent to ISO 100, 25600, or 51200
  - **Movies:** Standard output sensitivity equivalent to ISO 200–12800 in increments of  $\frac{1}{3}$  EV

**Metering** 256-segment through-the-lens (TTL) metering; MULTI, SPOT, AVERAGE, CENTER WEIGHTED

**Exposure control** Programmed AE (with program shift); shutter-priority AE; aperture-priority AE; manual exposure

- Exposure compensation**
- **Still pictures:** –5 EV–+5 EV in increments of  $\frac{1}{3}$  EV
  - **Movies:** –2 EV–+2 EV in increments of  $\frac{1}{3}$  EV

Shutter speed	Mode P	Other modes	Time	Bulb
<b>Mechanical shutter</b>	4 s to $\frac{1}{4000}$ s	30 s to $\frac{1}{4000}$ s		Max. 60 min.
<b>Electronic shutter</b>	4 s to $\frac{1}{32000}$ s	30 s to $\frac{1}{32000}$ s		Fixed at 1 s
<b>Mechanical+ electronic</b>	4 s to $\frac{1}{32000}$ s	30 s to $\frac{1}{32000}$ s		Max. 60 min.

## System

Continuous		Frame rate	Frames per burst
CH	14 fps*	14	Up to approximately 42
	11 fps*	11	Up to approximately 50
	8.0 fps	8.0	Up to approximately 53
CL	5.0 fps	5.0	Up to approximately 56
	4.0 fps	4.0	Up to approximately 58
	3.0 fps	3.0	Up to approximately 62

\* Available with electronic shutter only.





















The frame rate varies with shooting conditions and the number of images recorded. In addition, the frame rate and number of frames per burst may vary depending on the type of memory card used.

<b>Focus</b>	<ul style="list-style-type: none"><li>• <b>Mode:</b> Single or continuous AF; manual focus with focus ring</li><li>• <b>Focus-area selection:</b> SINGLE POINT, ZONE, WIDE/TRACKING</li><li>• <b>Autofocus system:</b> Intelligent hybrid AF (TTL contrast-detect/phase-detection AF) with AF-assist illuminator</li></ul>
--------------	----------------------------------------------------------------------------------------------------------------------------------------------------------------------------------------------------------------------------------------------------------------------------------------------------------------------------

<b>White balance</b>	Custom 1, Custom 2, Custom 3, color temperature selection, auto, direct sunlight, shade, daylight fluorescent, warm white fluorescent, cool white fluorescent, incandescent, underwater
----------------------	-----------------------------------------------------------------------------------------------------------------------------------------------------------------------------------------

<b>Self-timer</b>	Off, 2 sec., 10 sec.
-------------------	----------------------

## System

<b>Flash mode</b>	<ul style="list-style-type: none"> <li>• <b>MODE:</b> TTL MODE (FLASH AUTO, STANDARD, SLOW SYNC.), MANUAL, COMMANDER, SUPPRESSED FLASH</li> <li>• <b>SYNC. MODE:</b> 1ST CURTAIN, 2ND CURTAIN</li> <li>• <b>RED EYE REMOVAL:</b>  FLASH+REMOVAL,  FLASH,  REMOVAL, OFF</li> </ul>		
<b>Hot shoe</b>	Accessory shoe with TTL contacts		
<b>Sync contact</b>	X contact; supports sync speeds as fast as $\frac{1}{180}$ s		
<b>Sync terminal</b>	Provided		
<b>Viewfinder</b>	0.39-in., 2,360k-dot color OLED viewfinder with diopter adjustment ( $-4$ to $+2$ $m^{-1}$ ); magnification $0.62\times$ with 50 mm lens (35 mm format equivalent) at infinity and diopter set to $-1.0$ $m^{-1}$ ; diagonal angle of view approximately $30.0^\circ$ (horizontal angle of view approximately $25.0^\circ$ ); eye point approx. 17.5 mm		
<b>LCD monitor</b>	3.0-in/7.6 cm, 1040k-dot color touchscreen LCD monitor, tilting		
<b>Movies (with stereo sound)</b>	 <b>4K</b> 2160/29.97P	 <b>1080</b> /59.94P	 <b>720</b> /59.94P
	 <b>4K</b> 2160/25P	 <b>1080</b> /50P	 <b>720</b> /50P
	 <b>4K</b> 2160/24P	 <b>1080</b> /29.97P	 <b>720</b> /29.97P
	 <b>4K</b> 2160/23.98P	 <b>1080</b> /25P	 <b>720</b> /25P
		 <b>1080</b> /24P	 <b>720</b> /24P
		 <b>1080</b> /23.98P	 <b>720</b> /23.98P

## Input/output terminals

<b>Digital input/output</b>	USB 2.0 High-Speed Micro USB connector (Micro-B)
<b>HDMI output</b>	HDMI Micro connector (Type D)
<b>Microphone/remote release connector</b>	∅2.5 mm 3-pole mini jack

## Power supply/other

<b>Power supply</b>	NP-W126S rechargeable battery (supplied with camera)
<b>Camera size</b> (W × H × D)	118.4 mm × 82.8 mm × 41.4 mm (31.9 mm excluding projections, measured at thinnest part)/ 4.7 in. × 3.3 in. × 1.6 in. (1.3 in.)
<b>Camera weight</b>	Approx. 333 g/11.7 oz., excluding battery, accessories, and memory card
<b>Shooting weight</b>	Approx. 383 g/13.5 oz., including battery and memory card
<b>Operating conditions</b>	<ul style="list-style-type: none"><li>• <b>Temperature:</b> -10 °C to +40 °C/ +14 °F to +104 °F</li><li>• <b>Humidity:</b> 10% to 80% (no condensation)</li></ul>



## Power supply/other

### Battery life

- **Battery type:** NP-W126S
- **Photographs:** The number of frames varies with the option selected for **PERFORMANCE**:

PERFORMANCE	LCD	EVF
<b>HIGH PERFORMANCE</b>	Approx. 260	Approx. 260
<b>STANDARD</b>	Approx. 350	Approx. 350

- **Movies:** The length of footage that can be recorded varies with the movie mode:

Mode	Actual Battery life of movie capture	Continuance Battery life of movie capture
	Approx. 50 minutes	Approx. 70 minutes
	Approx. 60 minutes	Approx. 95 minutes

CIPA standard, measured in mode **P**, using fully charged battery (NP-W126S), XF35mmF1.4 R lens, and SD memory card.

**Note:** Battery life varies with battery charge level and will decline at low temperatures.

## Wireless transmitter

<b>Standards</b>	IEEE 802.11b/g/n (standard wireless protocol)
<b>Operating frequency</b>	<ul style="list-style-type: none"><li>• <b>U. S. A., Canada, Taiwan:</b> 2,412 MHz–2,462 MHz (11 channels)</li><li>• <b>Other countries:</b> 2,412 MHz–2,472 MHz (13 channels)</li></ul>
<b>Access protocols</b>	Infrastructure

## NP-W126S rechargeable battery

<b>Nominal voltage</b>	7.2 V
<b>Nominal capacity</b>	1260 mAh
<b>Operating temperature</b>	0 °C to +40 °C/ +32 °F to +104 °F
<b>Dimensions</b> (W × H × D)	36.4 mm × 47.1 mm × 15.7 mm/ 1.4 in. × 1.9 in. × 0.6 in.
<b>Weight</b>	Approx. 47 g/1.7 oz.

**BC-W126 battery charger**

<b>Rated input</b>	100V – 240V AC, 50/60 Hz
<b>Input capacity</b>	13 – 21 VA
<b>Rated output</b>	8.4V DC, 0.6 A
<b>Supported batteries</b>	NP-W126S rechargeable batteries
<b>Charging time</b>	Approx. 150 minutes (+20 °C/+68 °F)
<b>Operating temperature</b>	5 °C to +40 °C/ +41 °F to +104 °F
<b>Dimensions</b> (W × H × D)	65 mm × 91.5 mm × 28 mm/ 2.6 in. × 3.6 in. × 1.1 in., excluding projections
<b>Weight</b>	Approx. 77 g/2.7 oz.

Weight and dimensions vary with the country or region of sale. Labels, menus, and other displays may differ from those on the actual camera.

 Specifications and performance are subject to change without notice. FUJIFILM will not be held liable for any errors this manual may contain. The appearance of the product may differ from that described in this manual.





# ***MEMO***

---

---

---

---

---

---

---

---

---

---

---

---

---

---

---

---

---

---

---

---

---

---

---

# MEMO

---

---

---

---

---

---

---

---

---

---

---

---

---

---

---

---

---

---

---

---

---

---

---



# FUJIFILM

---

## FUJIFILM Corporation

7-3, AKASAKA 9-CHOME, MINATO-KU, TOKYO 107-0052, JAPAN

[http://www.fujifilm.com/products/digital\\_cameras/index.html](http://www.fujifilm.com/products/digital_cameras/index.html)

