

Wireless Noise Canceling Stereo Headset
WF-1000X



Use this manual if you encounter any problems, or have any questions.
This Help Guide is also available as a PDF, which can be downloaded [here](#).

Getting started

What you can do with the BLUETOOTH function

About voice guidance

Supplied accessories

- └ Checking the package contents >
- └ Replacing the earbuds >
- └ Replacing the fitting supporters >

Parts and controls

- └ Location and function of parts >
- └ About the indicator >

Power/Charging

- └ Charging the headset >

- Available operating time >
- Checking the remaining battery charge >
- System requirements for battery charge using USB >
- Turning on the headset >
- Turning off the headset >

Making connections

How to make a wireless connection to BLUETOOTH devices

One-touch connection (NFC) compatible Android devices

- One-touch connection (NFC) with a smartphone (Android 4.1 or later) >
- Disconnecting the smartphone by one touch (NFC) >
- Switching the device by one touch (NFC) >

Android devices not compatible with one-touch connection (NFC)

- Pairing and connecting with an Android smartphone >
- Connecting to a paired Android smartphone >

iPhone (iOS devices)

- Pairing and connecting with an iPhone >
- Connecting to a paired iPhone >

Disconnecting BLUETOOTH connection (after use)

Listening to music

Listening to music via a BLUETOOTH connection

- Listening to music from a device via BLUETOOTH connection >
- Controlling the audio device (BLUETOOTH connection) >
- Disconnecting BLUETOOTH connection (after use) >

Noise canceling function

- What is noise canceling? >
- Using the noise canceling function >

Listening to ambient sound

- Listening to ambient sound during music playback (Ambient Sound Mode) >

Sound quality mode

- About the sound quality mode >

Supported codecs

Making phone calls

Receiving a call

Making a call

Functions for a phone call

Disconnecting BLUETOOTH connection (after use)

Using the voice assist function

Using the voice assist function (Google App)

Using the voice assist function (Siri)

Using the apps

What you can do with "Sony | Headphones Connect" app

Installing "Sony | Headphones Connect" app

What you can do with "Sony | Music Center" app

Installing "Sony | Music Center" app

Important information

Precautions

Trademarks

Customer support websites

Troubleshooting

What can I do to solve a problem?

Power/Charging

- The headset is not turned on. >
- Charging cannot be done. >
- Charging time is too long. >
- The charging case cannot be recognized by a computer. >
- The remaining battery charge of the headset is not displayed on the screen of an iPhone or iPod touch. >

Sound

- No sound >
- Low sound level >
- Low sound quality >

- Sound skips frequently during playback. >
- The noise canceling effect is not sufficient. >

BLUETOOTH

- Pairing cannot be done. >
- Unable to connect the headset to a BLUETOOTH device with one-touch connection (NFC) >
- Unable to make a BLUETOOTH connection >
- Distorted sound >
- The BLUETOOTH wireless communication range is short, or the sound skips. >
- The headset does not operate properly. >
- No voice from callers >
- Low voice from callers >

Resetting or initializing the headset

- Resetting the headset >
- Initializing the headset to restore factory settings >

Wireless Noise Canceling Stereo Headset
WF-1000X

What you can do with the BLUETOOTH function

The headset uses BLUETOOTH® wireless technology, allowing you to listen to music or make phone calls wirelessly.

Listening to music

You can receive audio signals from a smartphone or music player to enjoy music wirelessly.



Talking on the phone

You can make and receive a call with your hands free, while leaving your smartphone or mobile phone in your bag or pocket.



About voice guidance

You hear voice guidance in the following situations via the left unit of the headset.

- When powering on: "Power on"
- When powering off: "Power off"
- When entering pairing mode: "BLUETOOTH pairing"
- When establishing a BLUETOOTH connection: "BLUETOOTH connected"
- When disconnecting a BLUETOOTH connection: "BLUETOOTH disconnected"
- When the connection between the left unit and the right unit is established: "Battery level high" / "Battery level medium" / "Battery level low"
- When automatically turning off due to the low battery condition: "Please recharge headset"
- When turning on the noise canceling function: "Noise canceling"
- When turning on the Ambient Sound Mode: "Ambient sound"
- When turning off the noise canceling function and the Ambient Sound Mode : "Off"

Wireless Noise Canceling Stereo Headset
WF-1000X

Checking the package contents

After opening the package, check that all items in the list are included in the package. If items are missing, contact your dealer.

Numbers in () indicate the item amount.

Wireless Noise Canceling Stereo Headset (1)
Micro-USB cable (approx. 50 cm (19 3/4 in.)) (1)

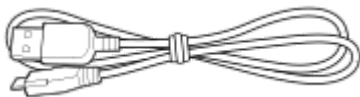

Charging case (1)

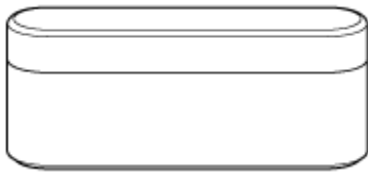

Long Hybrid silicone rubber earbuds (SS/S/M/L 2 each)

- Size M earbuds come attached to the headset.

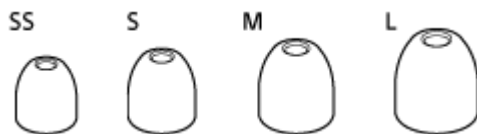

Triple-comfort earbuds (S/M/L 2 each)



Fitting supporters (M/L 2 each)

- Size M fitting supporters come attached to the headset.

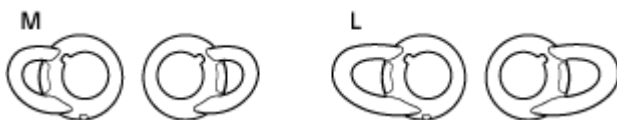

Reference Guide (1)
Operating Instructions (1)
Other documents (1 set) (*)

* May not be supplied in some countries or regions.

Replacing the earbuds

The headset comes with the M size long hybrid silicone rubber earbuds.

If the headset tends to come off or you feel a lack of low frequency sound, change the earbuds to another size to fit your right and left ears comfortably and snugly.

Long Hybrid silicone rubber earbuds



- A:** SS size (red)
 - B:** S size (orange)
 - C:** M size (green)
 - D:** L size (light blue)
- Triple-comfort earbuds



- A:** S size (orange)
- B:** M size (green)
- C:** L size (light blue)

1 Remove the earbuds.

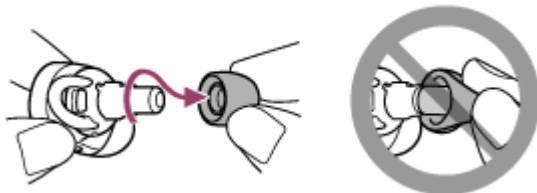

- Do not pinch the end of the earbud when removing it.

2 Attach the earbuds.



- Do not attach the earbuds loose or skewed.

Location and function of parts

Headset

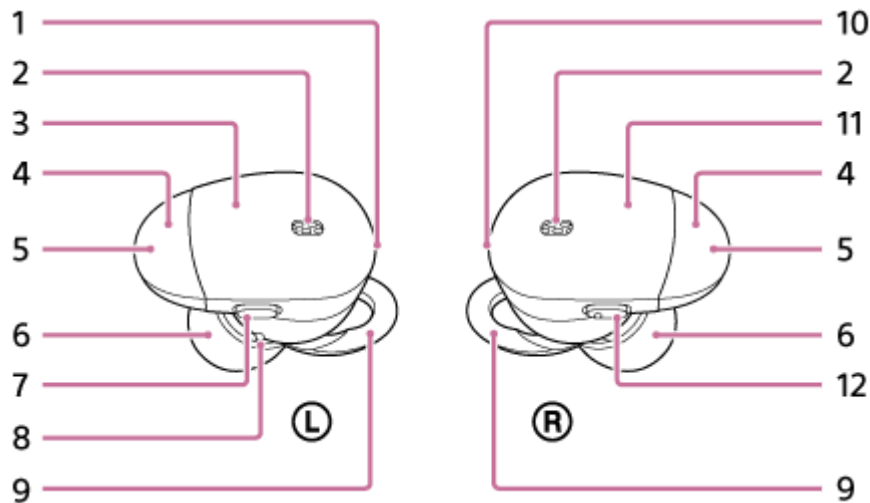

1. L mark
2. Microphone
Picks up the sound of your voice (when talking on the phone) and noise (when using the noise canceling function).
Use the microphone of the Ⓛ left unit when talking on the phone.
3. Ⓛ left unit
4. Built-in antenna
A BLUETOOTH antenna is built into the headset.
5. Indicator (blue/red)
Lights up in red during charging.
Lights up in red or blue to indicate the power or communication status of the headset.
6. Earbuds
7. ⏻ (power) button on the Ⓛ left unit
8. Tactile dot
The left unit has a tactile dot.
9. Fitting supporters
10. R mark
11. Ⓜ right unit
12. Button on the Ⓜ right unit

Charging case

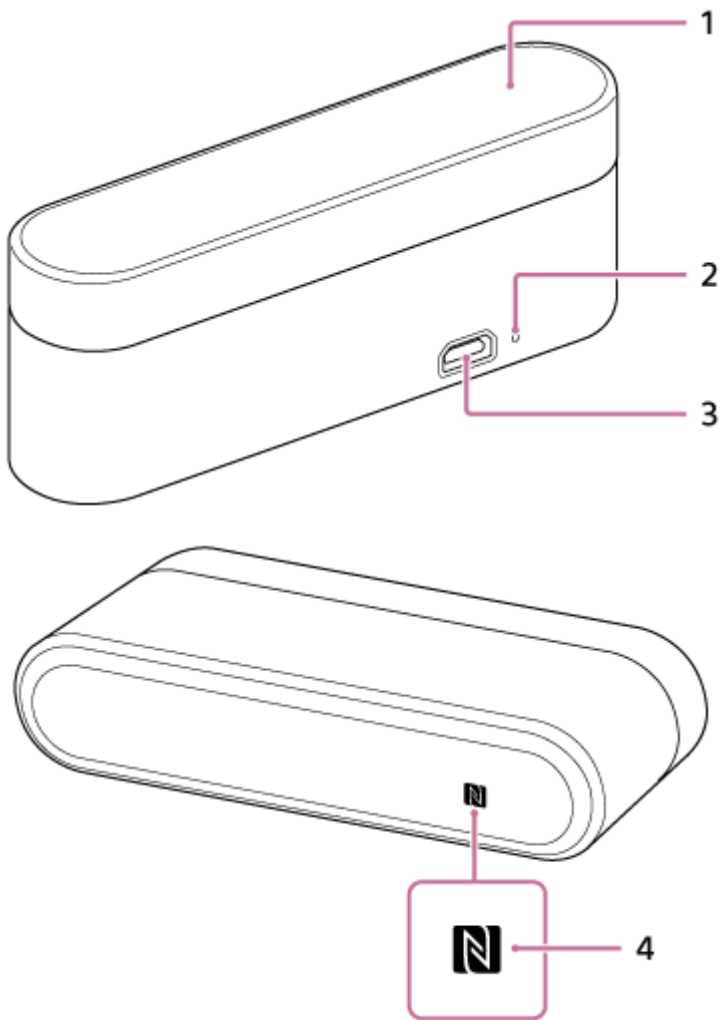

1. Cover
2. Charge indicator (red)
Lights up in red during charging the case.
3. Micro-USB port
Charges both the headset and the charging case by connecting a computer to this port with the supplied micro-USB cable.
4. N-mark

Related Topic

- [About the indicator](#)
- [Checking the remaining battery charge](#)

About the indicator

You can check various statuses of the headset by the indicators.

●: Turns on in blue/●: Turns on in red/-: Turns off

Turning on

● - ● (flashes two times)

Turning off

▬ (lights for about two seconds)

BLUETOOTH status indication

The indicator of the left unit lights up or flashes.

- Pairing mode

● ● ● ● ● ● ● ● ● ●

- Not connected

● - - ● - - ● - - ● (about one-second intervals)

- Connection process completed

● ● ● ● ● ● ● ● (flashes quickly for about five seconds)

- Connected

● - - - (about five-second interval) - - - ●

The indicator turns off after 60 seconds. By operating a button, the indicator flashes again.

- Incoming call

● ● ● ● ● ● ● ●

Remaining battery charge indication

- High

● - - ● - - ●

- Medium

● - - ●

- Low (needs to charge)

●

For details, refer to [“Checking the remaining battery charge.”](#)

Charging

- While charging

▬

Other

- Initialization completed



For details, refer to [“Initializing the headset to restore factory settings.”](#)

Hint

- When the remaining battery charge becomes low, the indicator turns from blue to red, except for pairing mode.

Charging the headset

The headset contains a lithium ion rechargeable battery. Charge the headset using the supplied micro-USB cable.

- 1 **Connect the supplied micro-USB cable to the charging case, and then connect the other end to a booted computer.**

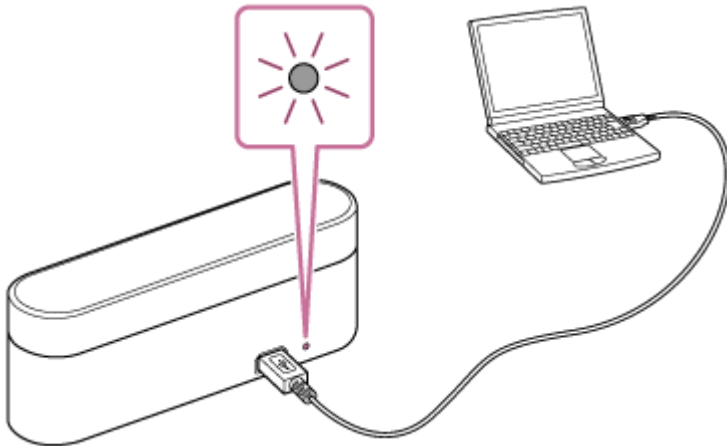

The indicator on the back side of the charging case lights up in red while charging.
The indicator turns off after charging is complete.

- 2 **Set the headset on the charging case.**

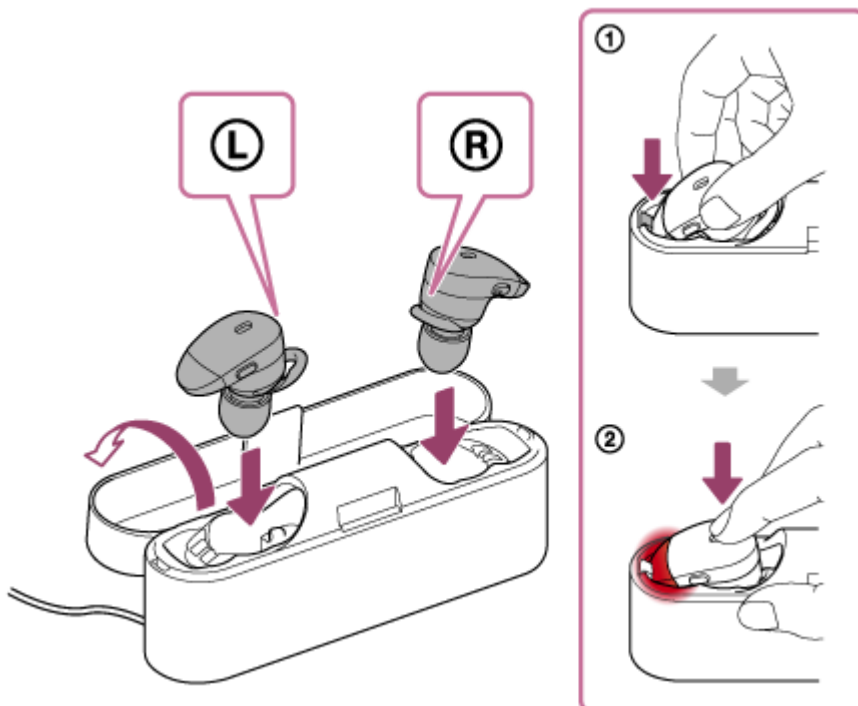

Set the **R** right and **L** left units in the order shown in the illustration (**1** then **2**).
Insert the **R** right unit and **L** left unit until they click and make sure that the units are locked in the charging case.

Both the headset and the charging case are charged when you charge the charging case.
The indicators both on the headset and the charging case (back side) light up in red while charging.
The respective indicator turns off after charging is complete.

About charging

The required times for full charging is as follows;

The Ⓜ right/Ⓛ left unit: about 1.5 hours

The charging case: about 3 hours

Charging the headset when you are outside

A rechargeable battery is built in the charging case. If you charge the charging case in advance, you can charge the headset with it when you are outside where there is no power supply.

If the charging case is charged fully, you can charge the headset about 2 times.

Notes on charging the headset when you are outside

- If the indicator (red) flashes and then turns off quickly when you set the headset on the charging case, you cannot charge the headset because the remaining power of the rechargeable battery (which is built in the charging case) is low. To turn on the headset, remove it from the charging case and then press and hold the buttons both on the Ⓜ right and Ⓛ left unit for about 2 seconds until the indicator (blue) flashes.
- If the indicator (red) does not light up/flash and the headset does not turn off even when you set the headset on the charging case, the remaining power of the rechargeable battery (which is built in the charging case) is empty. To turn off the headset, remove it from the charging case and then press and hold the button on the left unit for about 2 seconds until the indicator (blue) flashes. The Ⓛ left unit and Ⓜ right unit turn off.

Hint

- If charging starts while the headset is turned on, the headset will turn off automatically.

Note

- If the headset is not used for a long time, the battery may be quickly depleted, however, after a few recharges, the battery life will improve.
- If you store the headset for a long time, charge the battery to its full capacity once every 6 months to avoid over discharge.
- If the headset is not used for a long time, it may take longer to charge the battery.
- If the computer enters into hibernation mode while connected to the headset, charging will not be completed properly. Check the setting of the computer before charging. The indicator (red) will go off automatically if the computer enters into hibernation mode. Charge the headset again in this case.
- If the headset detects a problem while charging due to following causes, the indicator (red) may turn off, although charging is not complete. In this case, charge again within the charging temperature range. If the problem persists, consult your nearest Sony dealer.
 - Ambient temperature exceeds the charging temperature range of 5 °C – 35 °C(41 °F - 95 °F).
 - There is a problem with the battery.
- If the headset is not used for a long time, the indicator (red) may not light up when you connect the micro-USB cable to charge the headset. In this case, do not disconnect the micro-USB cable from the headset: wait a few minutes until the indicator (red) lights up.
- If the life of the built-in rechargeable battery drops significantly, the battery should be replaced. Consult your nearest Sony dealer for replacement of the rechargeable battery.
- Avoid exposure to temperature extremes, direct sunlight, moisture, sand, dust or mechanical shock. Never leave the headset in a car parked in the sun.
- Use the supplied micro-USB cable only, and connect directly to a computer. Charging will not be completed properly by an indirect connection, such as via a USB hub.

Available operating time

The available operating times of the headset on a fully-charged battery are as follows:

BLUETOOTH connection

Music Playback time

Codec	Noise canceling function/Ambient Sound Mode	Available operating time
AAC	Noise canceling function: ON	Max. 3 hours
	Ambient Sound Mode: ON	Max. 3 hours
	OFF	Max. 3 hours
SBC	Noise canceling function: ON	Max. 2 hours
	Ambient Sound Mode: ON	Max. 2 hours
	OFF	Max. 2.5 hours

- About 70 minutes of music playback is possible after 15 minutes charging.

Communication time: Max. 3.5 hours

Standby time

Noise canceling function/Ambient Sound Mode	Available operating time
Noise canceling function: ON	Max. 8 hours
Ambient Sound Mode: ON	Max. 8 hours
OFF	Max. 35 hours

Hint

- By using the "Sony | Headphones Connect" app, you can check which codec is used for a connection.

Note

- Usage hours may be different depending on the settings and conditions of use.

Related Topic

- [Supported codecs](#)
- [What you can do with "Sony | Headphones Connect" app](#)

Checking the remaining battery charge

You can check the remaining battery charge of the rechargeable battery.

The indicator (red) flashes when the connection between the left unit and the right unit is established. You also hear voice guidance of the remaining battery charge.

- 3 times ● - - ● - - ● : High “Battery level high”
- 2 times ● - - ● : Medium “Battery level medium”
- 1 time ● : Low (needs to charge) “Battery level low”

When the battery is almost empty

The indicator turns red. When the battery becomes empty, the headset sounds a warning beep, you hear voice guidance “Please recharge headset”, and the head set turns off automatically.

When you are using an iPhone or iPod touch

When the headset is connected to an iPhone or iPod touch (iOS 5.0 or later) that supports HFP (Hands-free Profile), it will show an icon that indicates the remaining battery charge of the headset on the screen.

Compatible devices

iPhone or iPod touch (iOS 5.0 or later) supporting Hands-free Profile (HFP)

iOS 10.2 or later

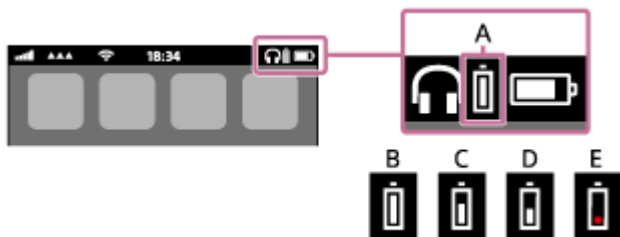

iOS 7.0 or later

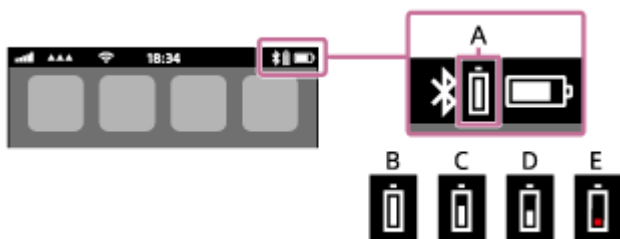

iOS 5.X / 6.X

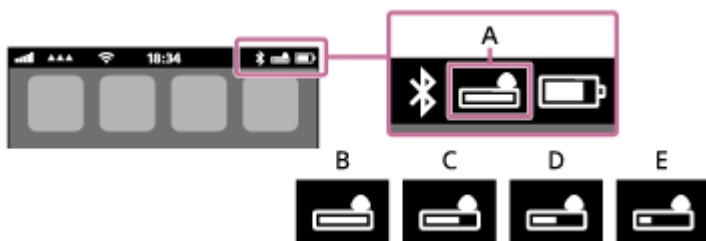

A: Remaining battery charge of the headset

B: 100% to 70%

C: 70% to 50%

D: 50% to 20%

E: 20% or lower (needs to charge)

Hint

- You can also check the remaining battery charge with the “Sony | Headphones Connect” app. Android smartphones and iPhone/iPod touch support this app.

Related Topic

- [What you can do with "Sony | Headphones Connect" app](#)

4-724-045-11(2) Copyright 2017 Sony Corporation

Wireless Noise Canceling Stereo Headset
WF-1000X

System requirements for battery charge using USB

The headset contains a lithium ion rechargeable battery, which should be charged before using the headset for the first time.

Personal Computer with pre-installed with any of the following operating systems and USB port:

- When using Windows®
Windows® 10 Home / Windows® 10 Pro
Windows® 8.1 / Windows® 8.1 Pro
Windows® 8 / Windows® 8 Pro
Windows® 7 Home Basic / Home Premium / Professional / Ultimate
- When using Mac
Mac OS X (version 10.9 or later)

Note

- Sony does not guarantee proper operation in all system environments.
- When using Windows 8.1 update using Windows Update.

Turning on the headset

Removing the headset from the charging case

The headset turns on automatically and the indicator (blue) flashes.

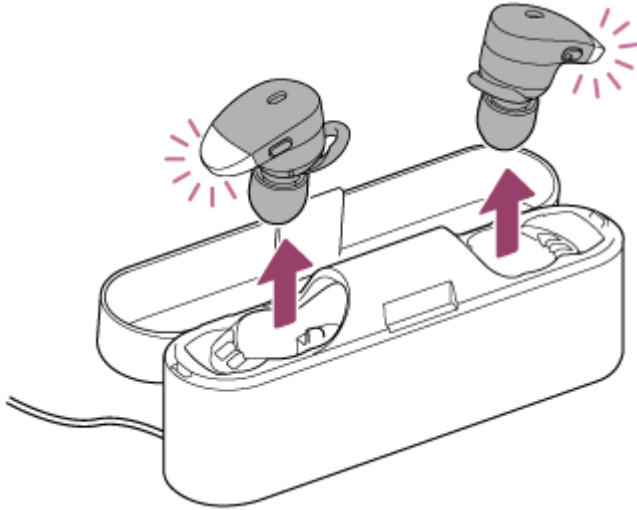

Pressing and holding the buttons of the headset

You can turn on the headset by operating the button of the headset when the headset is not set on the charging case.



Press and hold the buttons both on the ® right and Ⓛ left unit for about 2 seconds until the indicator (blue) flashes. The noise canceling function turns on automatically and the connection between the left unit and the right unit is established automatically.

The headset goes into pairing mode when turning on the headset for the first time after purchase.

Related Topic

- [Turning off the headset](#)

Turning off the headset

Setting the headset into the charging case



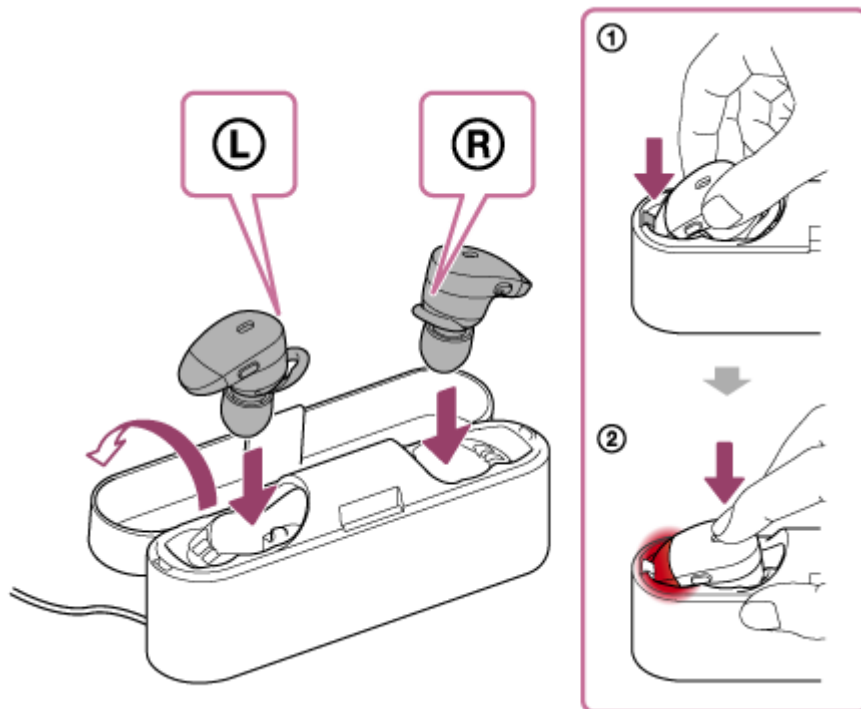

The headset turns off automatically.
The indicator (red) lights up in red during charging.
Set the units in the order shown in the illustration (① then ②).

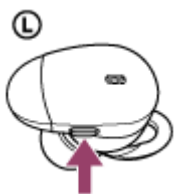

Pressing and holding the button of the headset

You can turn off the headset by operating the button of the headset when the headset is not set on the charging case.



Press and hold the  button on the  left unit for about 2 seconds until the indicator (blue) flashes. The  left unit and  right unit turn off.

Related Topic

- [Turning on the headset](#)

How to make a wireless connection to BLUETOOTH devices

You can enjoy music and hands-free calling with the headset wirelessly by using your device's BLUETOOTH function.

Device registration (pairing)

When using the BLUETOOTH function for the first time, you must previously register both devices to allow connection. The operation to register a device is called device registration (pairing).

If the device to be connected does not support the one-touch connection (NFC), operate the headset and the device to perform device registration (pairing).

If the device supports one-touch connection (NFC), you can just touch to perform device registration (pairing) and establish a BLUETOOTH connection.

Connecting the headset to a registered (paired) device

When the device is registered, it is not necessary to register it again. Connect to it with an appropriate method.

Wireless Noise Canceling Stereo Headset
WF-1000X

One-touch connection (NFC) with a smartphone (Android 4.1 or later)

By touching the headset with a smartphone, the headset pairs and makes a BLUETOOTH connection.

Compatible smartphones

NFC-compatible smartphones installed with Android™ 4.1 or later

NFC

NFC (Near Field Communication) is a technology enabling short-range wireless communication between various devices, such as smartphones and IC tags. Thanks to the NFC function, data communication - for example, BLUETOOTH pairing - can be achieved easily by simply touching NFC-compatible devices together (i.e., at the N-Mark symbol or location designated on each device).

- 1 **Unlock the screen of the smartphone if it is locked.**
- 2 **Select [Setting] — [More].**
- 3 **Set the NFC function to on.**

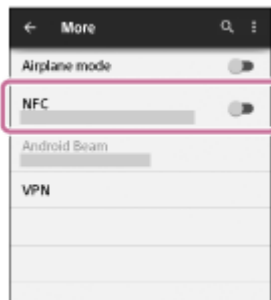

* The above procedure is an example. For details, refer to the operating instructions supplied with your Android smartphone.

- 4 **Remove the **R** right and **L** left units from the charging case.**

The headset will turn on automatically.

- 5 **Touch the smartphone with the bottom of the charging case.**

- Touch the smartphone on the N-Mark at the bottom of the charging case. Keep touching the smartphone with the charging case until the smartphone reacts.
- Refer to the operating instructions of the smartphone for the designated location to be touched on the smartphone.

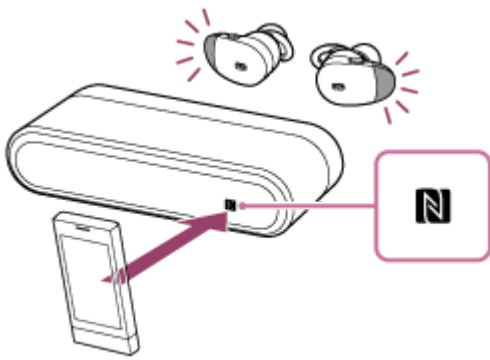

Follow the on-screen instructions to complete the pairing and connection.

When the headset is connected with the smartphone, the blue indicator starts flashing slowly. You hear voice guidance “BLUETOOTH connected”.



- To disconnect, touch the smartphone again.
- To connect a paired smartphone, perform step 5.
- Unlock the screen of the smartphone if it is locked.

Hint

- If you cannot connect the headset, try the following.
 - Unlock the screen of the smartphone if it is locked, and move the smartphone slowly over the N-Mark.
 - If the smartphone is in a case, remove the case.
- If you touch an NFC-compatible smartphone with the bottom of the charging case, the smartphone terminates BLUETOOTH connection with any current device, and connects to the headset (One-touch connection switching).
- When the power of the headset is off, you cannot turn on the headset with one-touch connection (NFC) to connect the headset with the smartphone. To turn the headset on, press and hold the buttons both on the **R** right and **L** left units for about 2 seconds on until the indicator (blue) flashes.

Related Topic

- [How to make a wireless connection to BLUETOOTH devices](#)
- [Disconnecting the smartphone by one touch \(NFC\)](#)
- [Switching the device by one touch \(NFC\)](#)
- [Listening to music from a device via BLUETOOTH connection](#)

Disconnecting the smartphone by one touch (NFC)

You can disconnect the headset from the connected smartphone by touching the bottom of the charging case with it.



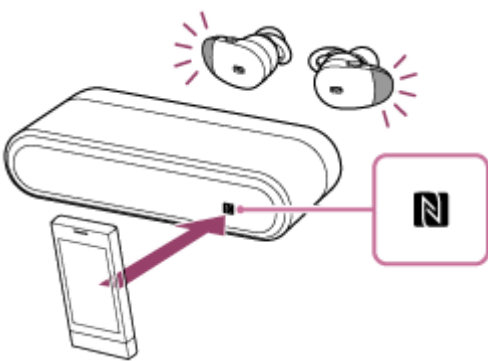

1 Unlock the screen of the smartphone if it is locked.

2 Touch the bottom of the charging case with the smartphone.

Touch the smartphone on the N-Mark of the bottom of the charging case. You hear voice guidance "BLUETOOTH disconnected".



Note

- After the headset is disconnected from the smartphone, if no operation is performed for about 5 minutes, the headset turns off automatically. To turn off the headset before that, press and hold the  button on the  left unit for about 2 seconds. You hear voice guidance "Power off", the indicator (blue) goes off, then the headset turns off. The headset will turn off automatically, even when you set the  right and  left units on the charging case.

Switching the device by one touch (NFC)

- When the headset is connected with a BLUETOOTH device, if you touch an NFC-compatible smartphone on the bottom of the charging case, the headset is connected with the smartphone that touched on the headset most recently (One-touch connection switching). However, if you are talking on a BLUETOOTH mobile phone connected to the headset, you cannot switch the BLUETOOTH connection by one touch.
- When the headset is connected with an NFC-compatible smartphone, if you touch the smartphone on another NFC-compatible BLUETOOTH headset or BLUETOOTH speaker, the smartphone disconnects from the headset, and connects to the BLUETOOTH device it touched.

Note

- Unlock the screen of the smartphone if it is locked.

Pairing and connecting with an Android smartphone

Pairing is the process required to create a link between BLUETOOTH devices to allow wireless connection. You must pair a device with the headset to be able to make a BLUETOOTH connection for the first time. Before you start pairing operation, make sure that:

- The smartphone is placed within 1 m(3 feet) of the headset.
- The headset is charged sufficiently.
- The operating instructions of the smartphone is on hand.

1 Set the headset on the charging case.

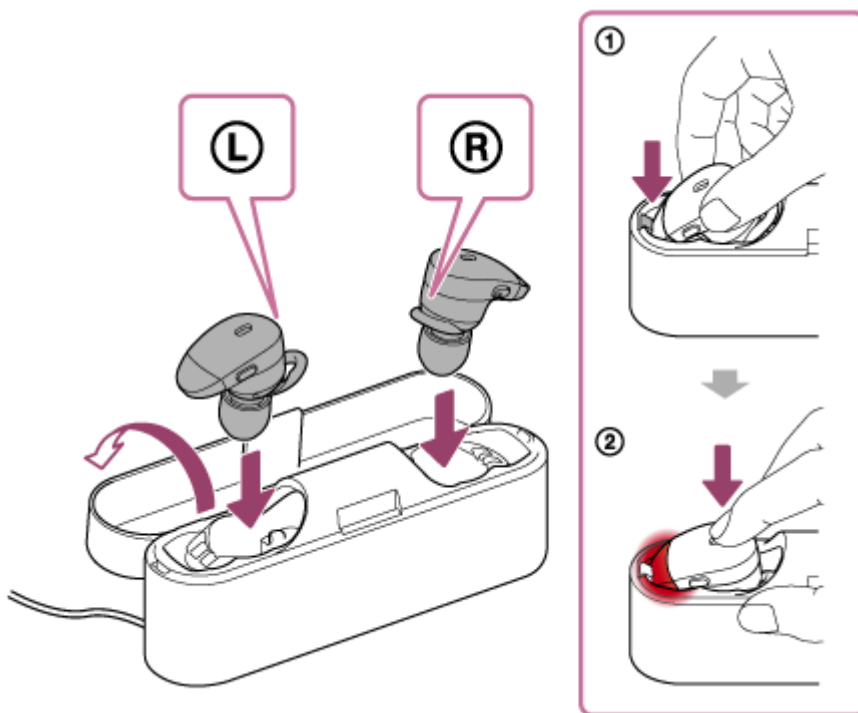

Set the units in the order shown in the illustration (① then ②).

Insert the ② right unit and ① left unit until they click and make sure that the units are locked in the charging case.

2 Remove the ① left unit from the charging case to turn on the unit.

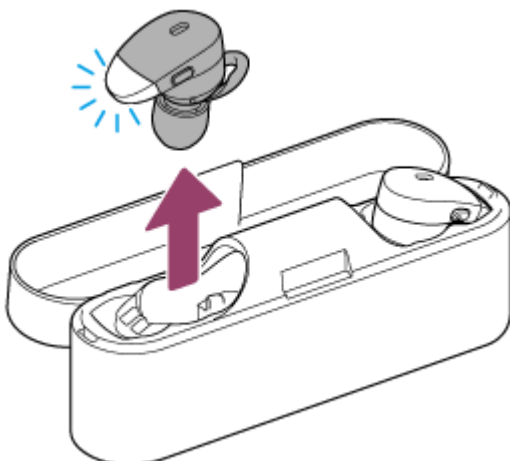

Do not remove the ⑥ right unit from the charging case. The ④ left unit turns on automatically. Make sure that the indicator (blue) flashes.

- 3 Press and hold the button on the ④ left unit for about 7 seconds until the indicator flashes blue and red alternately.**

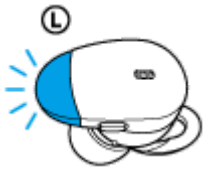

The headset goes into the pairing mode.

- 4 Unlock the screen of the Android smartphone if it is locked.**

- 5 Search for this headset on the smartphone.**

1. Select [Setting] - [Bluetooth].

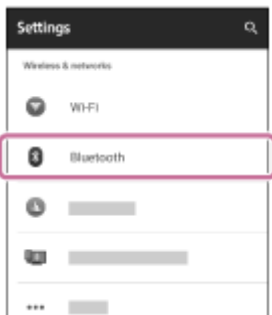

2. Touch [●●] next to [Bluetooth] to turn on the BLUETOOTH function.

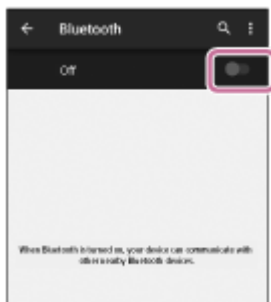

- 6 Touch [WF-1000X].**

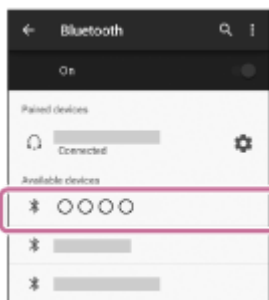

If passkey (*) input is required on the display of the smartphone, input "0000."

The headset and the smartphone are paired with each other and connected. You hear voice guidance "BLUETOOTH connected".

If they are not connected, see "[Connecting to a paired Android smartphone.](#)"

If [WF-1000X] does not appear on the display, try again from step 3.

* A Passkey may be called a "Passcode," a "PIN code," or a "Password."

7 Remove the **R** right unit from the charging case to turn on the unit.

The connection between the **L** left unit and the **R** right unit is established automatically.

Hint

- The above procedure is an example. For details, refer to the operating instructions supplied with your Android smartphone.
- To delete all pairing information, see "[Initializing the headset to restore factory settings.](#)"

Note

- If pairing is not established within about 5 minutes, pairing mode will be canceled and the headset will turn off. In this case, start over from step 1.
- Once BLUETOOTH devices are paired, there is no need to pair them again, except in the following cases:
 - Pairing information has been deleted after repair, etc.
 - The headset is already paired with 8 devices and another device is to be paired.
The headset can be paired with up to 8 devices. If a new device is paired after 8 devices are already paired, the paired device with the oldest connection time is replaced by the new one.
 - When the pairing information for the headset has been deleted from the BLUETOOTH device.
 - When the headset is initialized, all pairing information is deleted.
In this case, delete the pairing information of the headset from the BLUETOOTH device, and then pair them again.
- The headset can be paired with multiple devices, but can only play music from one paired device at a time.

Related Topic

- [How to make a wireless connection to BLUETOOTH devices](#)
- [Connecting to a paired Android smartphone](#)
- [Listening to music from a device via BLUETOOTH connection](#)
- [Initializing the headset to restore factory settings](#)

Connecting to a paired Android smartphone

1 Unlock the screen of the Android smartphone if it is locked.

2 Turn on the headset.

Press and hold the buttons both on the **R** right and **L** left units for about 2 seconds.

The headset will turn on automatically, even when you remove the **R** right and **L** left units from the charging case.



Make sure that the indicator (blue) flashes after you release the button. You hear voice guidance "Power on".



After the headset turns on, if it has automatically connected to the last connected device, you hear voice guidance "BLUETOOTH connected".

Check the connection status on the Android smartphone. If not connected, proceed to step 3.

3 Display the devices paired with the smartphone.

1. Select [Setting] - [Bluetooth].



2. Touch [●●] next to [Bluetooth] to turn on the BLUETOOTH function.

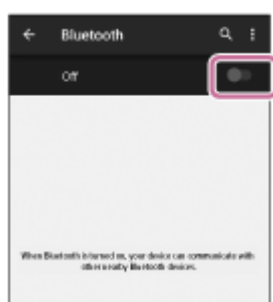

4 Touch [WF-1000X].

You hear voice guidance “BLUETOOTH connected”.

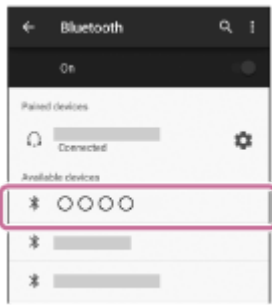

Hint

- The above procedure is an example. For details, refer to the operating instructions supplied with your smartphone.
- If the smartphone was connected with the headset the last time, an HFP/HSP connection is made when you turn on the headset. While the headset is on, you can make an A2DP connection (music playback) by pressing the button on the Ⓜ right unit.

Note

- If the last-connected BLUETOOTH device is put near the headset, the headset may connect automatically to the device by simply turning on the headset. In this case, deactivate the BLUETOOTH function on the BLUETOOTH device or turn off the power.
- If you cannot connect your smartphone to the headset, deactivate pairing on your smartphone and perform pairing again. For details, refer to the operating instructions supplied with your smartphone.

Related Topic

- [How to make a wireless connection to BLUETOOTH devices](#)
- [Pairing and connecting with an Android smartphone](#)
- [Listening to music from a device via BLUETOOTH connection](#)

Pairing and connecting with an iPhone

Pairing is the process required to create a link between BLUETOOTH devices to allow wireless connection. You must pair a device with the headset to be able to make a BLUETOOTH connection for the first time. Before you start pairing operation, make sure that:

- The iPhone is placed within 1 m(3 feet) of the headset.
- The headset is charged sufficiently.
- The operating instructions of the iPhone is on hand.

1 Set the headset on the charging case.

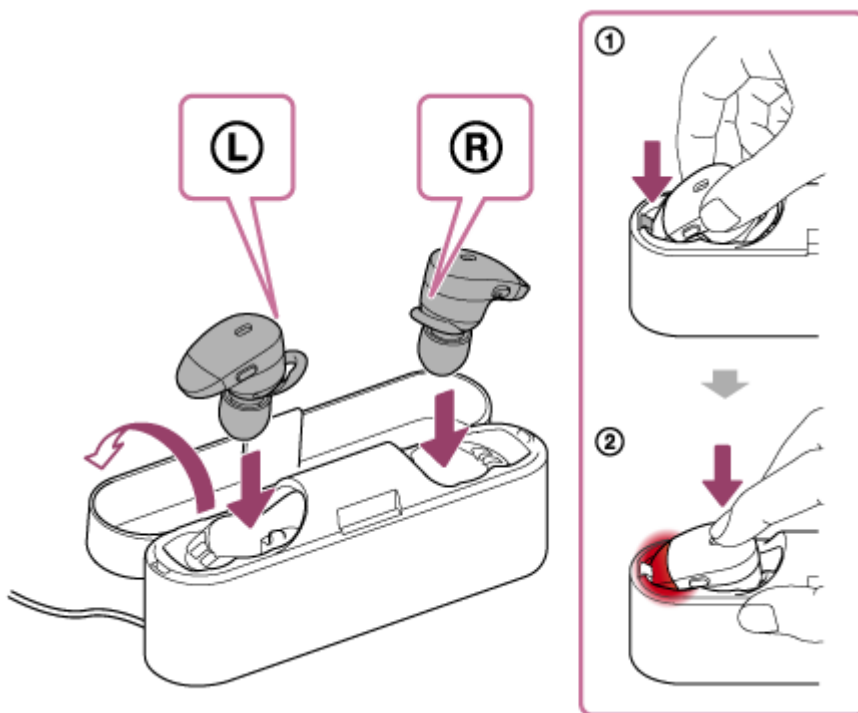

Set the units in the order shown in the illustration (① then ②).

Insert the ② right unit and ① left unit until they click and make sure that the units are locked in the charging case.

2 Remove the ① left unit from the charging case to turn on the unit.

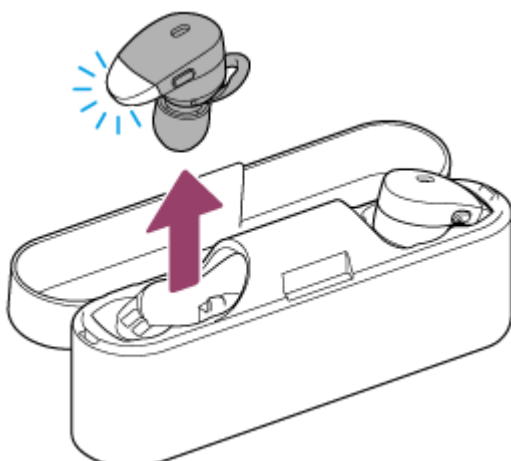

Do not remove the ⑥ right unit from the charging case. The ④ left unit turns on automatically. Make sure that the indicator (blue) flashes.

- 3 Press and hold the button on the ④ left unit for about 7 seconds until the indicator flashes blue and red alternately.

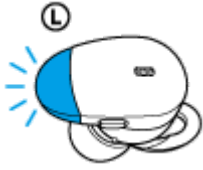

The headset goes into the pairing mode.

- 4 Unlock the screen of the iPhone if it is locked.

- 5 Select the BLUETOOTH setting on the iPhone.

1. Select [Settings].
2. Touch [Bluetooth].

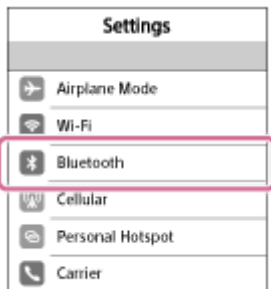

3. Touch [] to change it to [] (turn on the BLUETOOTH function).



- 6 Touch [WF-1000X].



If passkey (*) input is required on the display of the iPhone, input "0000."

The headset and the iPhone are paired with each other and connected. You hear voice guidance "BLUETOOTH connected".

If they are not connected, see "[Connecting to a paired iPhone.](#)"

If [WF-1000X] does not appear on the display, try again from step 3.

* A Passkey may be called a "Passcode," a "PIN code," or a "Password."

7 Remove the **Ⓡ** right unit from the charging case to turn on the unit.

The connection between the **Ⓛ** left unit and the **Ⓡ** right unit is established automatically.

Hint

- The above procedure is an example. For details, refer to the operating instructions supplied with your iPhone.
- To delete all pairing information, see "[Initializing the headset to restore factory settings.](#)"

Note

- If pairing is not established within about 5 minutes, pairing mode will be canceled and the headset will turn off. In this case, start over from step 1.
- Once BLUETOOTH devices are paired, there is no need to pair them again, except in the following cases:
 - Pairing information has been deleted after repair, etc.
 - The headset is already paired with 8 devices and another device is to be paired.
The headset can be paired with up to 8 devices. If a new device is paired after 8 devices are already paired, the paired device with the oldest connection time is replaced by the new one.
 - When the pairing information for the headset has been deleted from the BLUETOOTH device.
 - When the headset is initialized, all pairing information is deleted.
In this case, delete the pairing information of the headset from the BLUETOOTH device, and then pair them again.
- If the pairing information was deleted by initializing the headset, etc., delete from your iPhone the pairing information for the headset, and then pair them again.
- The headset can be paired with multiple devices, but can only play music from one paired device at a time.

Related Topic

- [How to make a wireless connection to BLUETOOTH devices](#)
- [Connecting to a paired iPhone](#)
- [Listening to music from a device via BLUETOOTH connection](#)
- [Initializing the headset to restore factory settings](#)

Connecting to a paired iPhone

1 Unlock the screen of the iPhone if it is locked.

2 Turn on the headset.

Press and hold the buttons both on the **R** right and **L** left units for about 2 seconds. The headset will turn on automatically, even when you remove the **R** right and **L** left units from the charging case.



Make sure that the indicator (blue) flashes after you release the button. You hear voice guidance "Power on".



After the headset turns on, if it has automatically connected to the last connected device, you hear voice guidance "BLUETOOTH connected".

Check the connection status on the iPhone. If not connected, proceed to step 3.

3 Display the devices paired with the iPhone.

1. Select [Settings].
2. Touch [Bluetooth].



3. Touch [] to change it to [] (turn on the BLUETOOTH function).

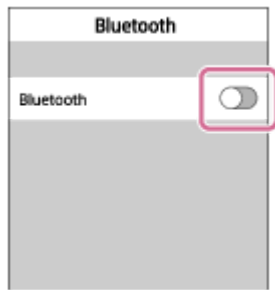

4 Touch [WF-1000X].

You hear voice guidance “BLUETOOTH connected”.



Hint

- The above procedure is an example. For details, refer to the operating instructions supplied with your iPhone.
- If the iPhone was connected with the headset the last time, an HFP/HSP connection is made when you turn on the headset. While the headset is on, you can make an A2DP connection (music playback) by pressing the button of the  right unit.

Note

- If the last-connected BLUETOOTH device is put near the headset, the headset may connect automatically to the device by simply turning on the headset. In this case, deactivate the BLUETOOTH function on the BLUETOOTH device or turn off the power.
- If you cannot connect your iPhone to the headset, deactivate pairing on your iPhone and perform pairing again. For details, refer to the operating instructions supplied with your iPhone.

Related Topic

- [How to make a wireless connection to BLUETOOTH devices](#)
- [Pairing and connecting with an iPhone](#)
- [Listening to music from a device via BLUETOOTH connection](#)

Disconnecting BLUETOOTH connection (after use)

- 1 If using a device that supports one-touch connection (NFC), touch the device to the headset again. (Unlock the screen of the device if it is locked.) If using a device that does not support one-touch connection (NFC), operate from the BLUETOOTH device.**

When disconnected, you hear voice guidance "BLUETOOTH disconnected".

- 2 Turn off the headset.**

You hear voice guidance "Power off".

Hint

- When you finish playing music, the BLUETOOTH connection may terminate automatically, depending on the BLUETOOTH device.

Related Topic

- [Disconnecting the smartphone by one touch \(NFC\)](#)
- [Turning off the headset](#)

Wireless Noise Canceling Stereo Headset
WF-1000X

Listening to music from a device via BLUETOOTH connection

You can enjoy listening to music and basic remote control operation of a BLUETOOTH device via a BLUETOOTH connection. The BLUETOOTH device is required to support the following BLUETOOTH profiles.

- A2DP (Advanced Audio Distribution Profile):
enables you to enjoy high-quality audio content wirelessly.
- AVRCP (Audio Video Remote Control Profile):
enables you to control playback, etc.

The operation may vary depending on the BLUETOOTH device. Refer to the operating instructions supplied with your BLUETOOTH device.

1 Connect the headset to a BLUETOOTH device.

2 Wear the headset.

Put the headset with **L** indication on your left ear and **R** indication on your right ear. The **L** left unit of the headset has a tactile dot.

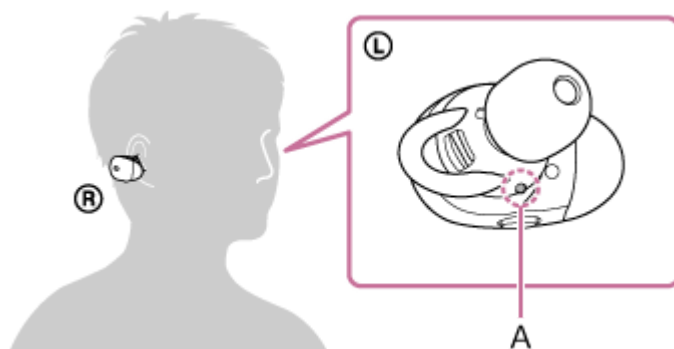

A: Tactile dot

Secure the fitting supporter to your ear dent. Apply the unit to your ear diagonally and lift the front of unit to fit the fitting supporter into your ear dent as follows.



3 Play back music or video on the BLUETOOTH device.

Adjust the volume on the BLUETOOTH device.

Hint

- The headset supports SCMS-T content protection. You can enjoy music, etc., from a device such as a portable TV that supports SCMS-T content protection.

- Depending on the BLUETOOTH device, it may be necessary to adjust the volume or set the audio output setting on the BLUETOOTH device.

Note

- For volume, control with the connected device. If you cannot control the volume with the connected device, install the "Sony | Music Center" app in your smartphone to control the volume with the app.
- If the communication condition is poor, the BLUETOOTH device may react incorrectly to the operation on the headset.

Related Topic

- [How to make a wireless connection to BLUETOOTH devices](#)
- [Controlling the audio device \(BLUETOOTH connection\)](#)
- [Using the noise canceling function](#)
- [What you can do with "Sony | Music Center" app](#)

Wireless Noise Canceling Stereo Headset
WF-1000X

Controlling the audio device (BLUETOOTH connection)

If the BLUETOOTH device supports AVRCP, you can control it by the headset. The functions available may vary depending on the BLUETOOTH device. Refer to the operating instructions supplied with your BLUETOOTH device.

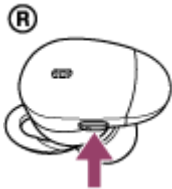

Press the button on the ® right unit.

- Press once quickly during pause to start playback.
- Press once quickly during playback to pause.
- Press twice to skip to the beginning of the next track (●●).
- Press three times to skip to the beginning of the previous (or current) track (●●●).
- Press once and release, and then press and hold to fast-forward (● [bar]).
- Press twice and release, and then press and hold to fast-reverse (●● [bar]).

Note

- For volume, control with the connected device. If you cannot control the volume with the connected device, install the "Sony | Music Center" app in your smartphone to control the volume with the app.
- If the communication condition is poor, the BLUETOOTH device may react incorrectly to the operation on the headset.
- The available functions may vary depending on the BLUETOOTH device. When you operate as illustrated above, it may operate differently or may not work at all.

Related Topic

- [What you can do with "Sony | Music Center" app](#)

Disconnecting BLUETOOTH connection (after use)

- 1 If using a device that supports one-touch connection (NFC), touch the device to the headset again. (Unlock the screen of the device if it is locked.) If using a device that does not support one-touch connection (NFC), operate from the BLUETOOTH device.**

When disconnected, you hear voice guidance "BLUETOOTH disconnected".

- 2 Turn off the headset.**

You hear voice guidance "Power off".

Hint

- When you finish playing music, the BLUETOOTH connection may terminate automatically, depending on the BLUETOOTH device.

Related Topic

- [Disconnecting the smartphone by one touch \(NFC\)](#)
- [Turning off the headset](#)

What is noise canceling?

The noise canceling circuit actually senses outside noise with built-in microphones and sends an equal-but-opposite canceling signal to the headset.

Note

- The noise canceling effect may not be pronounced in a very quiet environment, or some noise may be heard.
- Depending on how you wear the headset, the noise canceling effect may vary or a beeping sound (howling) may occur. In these cases, take off the headset and put it on again.
- The noise canceling function works for noise in the low frequency band primarily. Although noise is reduced, it is not canceled completely.
- When you use the headset in a train or a car, noise may occur depending on street conditions.
- Mobile phones may cause interference and noise. Should this occur, locate the headset further away from the mobile phone.
- Do not cover the microphones of the headset with your hands. The noise canceling function or the Ambient Sound Mode may not work properly, or a beeping sound (howling) may occur. In these cases, take your hands off of the microphones of the headset.

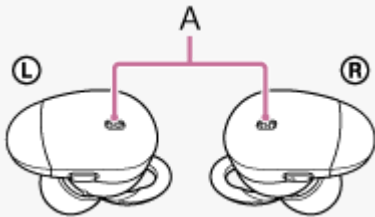

A: Microphones

Related Topic

- [Using the noise canceling function](#)

Using the noise canceling function



If you use the noise canceling function, you can enjoy music without being disturbed by ambient noise.

1 Turn on the headset.

You hear voice guidance "Power on".

The noise canceling function is turned on automatically when you turn on the headset.

To turn off the noise canceling function

Press the  button on the  left unit repeatedly.

Each time you press the button, the function is switched as follows. You hear voice guidance which informs the switching of the function.

The Ambient Sound Mode: ON



The noise canceling function/The Ambient Sound Mode: OFF



The noise canceling function: ON

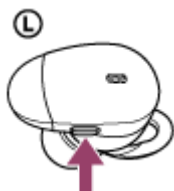

Hint

- You can also turn on/off the noise canceling function with the "Sony | Headphones Connect" app.

Note

- If the earbuds are not the supplied ones, the effect of the noise canceling function will be insufficient.
- If the earbuds are not attached to your ears securely, the effect of the noise canceling function will be insufficient. Adjust the headset position to fit your ears.

Related Topic

- [About voice guidance](#)
- [Turning on the headset](#)
- [What is noise canceling?](#)
- [Listening to ambient sound during music playback \(Ambient Sound Mode\)](#)
- [What you can do with "Sony | Headphones Connect" app](#)

Wireless Noise Canceling Stereo Headset
WF-1000X

Listening to ambient sound during music playback (Ambient Sound Mode)

You can hear ambient sound through the microphones embedded in the left/right units of the headset while enjoying music.

To activate the Ambient Sound Mode

Press the  button on the  left unit repeatedly while the noise canceling function is on.





To change the setting of the Ambient Sound Mode

You can switch Normal mode and Voice mode (settings of the Ambient Sound Mode) by connecting the smartphone (installed with the “Sony | Headphones Connect” app) and the headset via the BLUETOOTH function.

Normal mode: While enjoying music, you can hear the surround sound as if you were not wearing the headset.

Voice mode: While enjoying music, you can pick up the sound (such as information in the train) that you want to hear.

To deactivate the Ambient Sound Mode

Press the  button on the  left unit repeatedly until the noise canceling function is turned on or off.

Each time you press the button, the function is switched as follows. You hear voice guidance which informs the switching of the function.

The Ambient Sound Mode: ON



The noise canceling function/The Ambient Sound Mode: OFF



The noise canceling function: ON

Hint

- Depending on the ambient condition and type/volume of the audio played back, ambient sound may not be heard even if you use the Ambient Sound Mode. Do not use the headset in places where it would be dangerous if you are unable to hear ambient sound, such as a road with car traffic.
- If the headset is not worn properly, the Ambient Sound Mode may not work correctly. Wear the headset properly.
- The setting of the Ambient Sound Mode changed with the “Sony | Headphones Connect” app is recorded in the headset. You can enjoy music with the recorded setting of the Ambient Sound Mode even when you connect the headset to other devices which do not have the “Sony | Headphones Connect” app installed.

Related Topic

- [About voice guidance](#)
- [Using the noise canceling function](#)
- [What you can do with "Sony | Headphones Connect" app](#)

4-724-045-11(2) Copyright 2017 Sony Corporation

Wireless Noise Canceling Stereo Headset
WF-1000X

About the sound quality mode

The sound quality mode has the following two modes. You can switch or check the sound quality mode with the “Sony | Headphones Connect” app.

Priority on sound quality: prioritizes the sound quality (default).

Priority on stable connection: prioritizes the stable connection.

- When using an AAC compatible device, use with the “Priority on sound quality” mode.
- If the connection is unstable, such as when producing only intermittent sound, select the “Priority on stable connection” mode.

Note

- The playback time may become shorter, depending on the sound quality and the conditions under which you are using the headset.
- Depending on the ambient conditions in the area where you are using the headset, intermittent sound may still occur, even if the “Priority on stable connection” mode is selected.

Related Topic

- [What you can do with "Sony | Headphones Connect" app](#)

Wireless Noise Canceling Stereo Headset
WF-1000X

Supported codecs

A codec is an audio coding algorithm used when transmitting sound via a BLUETOOTH connection. The headset supports the following 2 codecs for music playback via an A2DP connection: SBC and AAC.

- SBC

This is an abbreviation for Subband Codec.

This is the standard audio coding technology used by BLUETOOTH devices.

All BLUETOOTH devices support SBC.

- AAC

This is an abbreviation for Advanced Audio Coding.

AAC is mainly used by Apple products such as iPhones, and it provides higher sound quality than that of SBC.

With the headset set to the “Priority on sound quality” mode, when music in one of the above codecs is transmitted from a connected device, the headset switches to that codec automatically and plays back the music in the same codec. However, depending on the device to be connected with the headset, you may need to set the device beforehand to listen to music in a different codec on the headset, even if the device supports a codec of higher sound quality than SBC. Refer to the operating instructions supplied with the device regarding setting the codec.

Related Topic

- [About the sound quality mode](#)

Receiving a call

You can enjoy a hands-free call with a smartphone or mobile phone that supports the BLUETOOTH profile HFP (Hands-free Profile) or HSP (Headset Profile), via a BLUETOOTH connection.

- If your smartphone or mobile phone supports both HFP and HSP, set it to HFP.
- Operations may vary depending on the smartphone or mobile phone. Refer to the operating instructions supplied with your smartphone or mobile phone.
- This headset supports normal incoming calls only. Calling apps for smartphones and computers are not supported.

Ring tone

When an incoming call arrives, a ring tone will be heard from the left unit of the headset, and the indicator (blue) flashes quickly.

You will hear either of following ring tones, depending on your smartphone or mobile phone.

- Ring tone set on the headset
- Ring tone set on the smartphone or mobile phone
- Ring tone set on the smartphone or mobile phone only for a BLUETOOTH connection

1 Connect the headset to a smartphone or mobile phone beforehand.

2 When you hear a ring tone, press the button on the **R** right or **L** left unit of the headset and receive the call.

A voice will be heard from the left unit of the headset.

When an incoming call arrives even while you are listening to music, playback pauses and a ring tone will be heard from the headset.

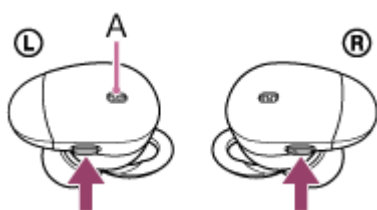

A: Microphone

Use the microphone of the **L** left unit (which suppresses noise when using the noise canceling function) for talking on the phone.

If no ring tone is heard via the headset

- The headset may not be connected with the smartphone or mobile phone with HFP or HSP. Check the connection status on the smartphone or mobile phone.
- If playback does not pause automatically, operate the headset to pause playback.

3 Operate the smartphone or mobile phone to adjust the volume.

4 To end the call, press the button on the **R** right or **L** left unit.

If you received a call during music playback, music playback resumes automatically.

Hint

- Some smartphones or mobile phones by default receive calls with the phone instead of the headset. With an HFP or HSP connection, switch the call device to the headset by holding the button of the right unit down for about 2 seconds or by using your smartphone or mobile phone.

Note

- Depending on the smartphone or mobile phone, playback may not resume automatically even if you finish the call.
- Use a smartphone or mobile phone at least 50 cm(19 3/4 in.) away from the headset. Noise may result if the headset and the smartphone or mobile phone are too close.

Related Topic

- [How to make a wireless connection to BLUETOOTH devices](#)
- [Making a call](#)
- [Functions for a phone call](#)
- [What you can do with "Sony | Headphones Connect" app](#)

Making a call

You can enjoy a hands-free call with a smartphone or mobile phone that supports the BLUETOOTH profile HFP (Hands-free Profile) or HSP (Headset Profile), via a BLUETOOTH connection.

- If your smartphone or mobile phone supports both HFP and HSP, set it to HFP.
- Operations may vary depending on the smartphone or mobile phone. Refer to the operating instructions supplied with your smartphone or mobile phone.
- This headset supports normal incoming calls only. Calling apps for smartphones and computers are not supported.

1 Connect the headset to a smartphone or mobile phone beforehand.

2 Operate your smartphone or mobile phone to make a call.

When you make a call, the dial tone is heard from the left unit of the headset.

If you make a call while you are listening to music, playback pauses.

If no dial tone is heard via the headset, switch the call device to the headset using your smartphone or mobile phone or by holding the button on the **(R)** right unit down for about 2 seconds.

A voice will be heard from the **(L)** left unit of the headset when talking on the phone.

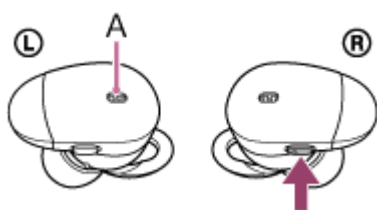

A: Microphone

Use the microphone of the **(L)** left unit (which suppresses noise when using the noise canceling function) for talking on the phone.

3 Operate the smartphone or mobile phone to adjust the volume.

4 To end the call, press the button on the **(R)** right or left **(L)** unit.

If you made a call during music playback, music playback resumes automatically after ending the call.

Note

- Use a smartphone or mobile phone at least 50 cm (19 3/4 in.) away from the headset. Noise may result if the headset and the smartphone or mobile phone are too close.

Related Topic

- [How to make a wireless connection to BLUETOOTH devices](#)
- [Receiving a call](#)
- [Functions for a phone call](#)

Wireless Noise Canceling Stereo Headset
WF-1000X

Functions for a phone call

The available functions may vary depending on the profile supported by your smartphone or mobile phone. Even if the profile is the same, functions may vary depending on the smartphone or mobile phone. Refer to the operating instructions supplied with your smartphone or mobile phone.

Supported profile: HFP (Hands-free Profile)

During standby/music playback

- Press the button on the right unit for about 2 seconds to start the voice dial function of the smartphone/mobile phone (*), activate Siri of the iPhone.

Outgoing call

- Press the button on the right unit once to cancel an outgoing call.
- Press and hold the button on the right unit for about 2 seconds to change the call device between the headset and the smartphone or mobile phone.

Incoming call

- Press the button on the right or left unit once to answer a call.
- Press and hold the button on the right or left unit for about 2 seconds to reject a call.

During call

- Press the button on the left or right unit once to finish a call.
- Press and hold the button on the right unit for about 2 seconds to change the call device between the headset and the smartphone or mobile phone.

Supported profile: HSP (Headset Profile)

Outgoing call

- Press the button on the right unit once to cancel an outgoing call. (*)

Incoming call

- Press the button on the right or left unit once to answer a call.

During call

- Press the button on the left or right unit once to finish a call. (*)

* Some devices may not support this function.

Related Topic

- [Receiving a call](#)
- [Making a call](#)

Disconnecting BLUETOOTH connection (after use)

- 1 If using a device that supports one-touch connection (NFC), touch the device to the headset again. (Unlock the screen of the device if it is locked.) If using a device that does not support one-touch connection (NFC), operate from the BLUETOOTH device.**

When disconnected, you hear voice guidance "BLUETOOTH disconnected".

- 2 Turn off the headset.**

You hear voice guidance "Power off".

Hint

- When you finish playing music, the BLUETOOTH connection may terminate automatically, depending on the BLUETOOTH device.

Related Topic

- [Disconnecting the smartphone by one touch \(NFC\)](#)
- [Turning off the headset](#)

Using the voice assist function (Google App)

By using the Google App feature that comes with the Android smartphone, you can speak to the headset's microphone to operate the Android smartphone.

When you use the Google App, you will hear the voice on the smartphone from the left unit only.

1 Turn the Google App on.

On the Android smartphone, select [Settings] — [Apps]. A gear icon appears in the top-right corner of the display. Select the gear icon, then [Default Apps] — [Assist & Voice input] — [Assist App], and then set [Assist App] to the Google App.

The operation above is an example. For details, refer to the operating instructions of the Android smartphone.

Note: The latest version of the app may be required.

For details on the Google App, refer to the operating instructions or support website of the Android smartphone.

The Google App may not be activated from the headset depending on specifications of the Android smartphone.

2 Connect the headset to the Android smartphone via BLUETOOTH connection.

3 When the Android smartphone is in standby or playing music, press and hold the button on the right unit to activate the Google App.

The Google App is activated and you will hear the start-up sound.

4 Make a request to the Google App through the headset's microphone.

For details on the Google App, such as apps which work with the Google App, refer to the operating instructions of the Android smartphone.

After activating the Google App, when a certain time has passed without requests, a beep will sound and the Google App will be deactivated.

Note

- The Google App cannot be activated when you say "OK Google" through the headset's microphone even when the Android smartphone's [OK Google] setting is on.

Using the voice assist function (Siri)

By using the Siri feature that comes with iPhone, you can speak to the headset's microphone to operate the iPhone. When you use Siri, you will hear the voice on the iPhone from the left unit only.

1 Turn Siri on.

On iPhone, select [Settings] — [Siri] to turn Siri on.

The operation above is an example. For details, refer to the operating instructions of the iPhone.

Note: For details on Siri, refer to the operating instructions or support website of the iPhone.

2 Connect the headset to the iPhone via BLUETOOTH connection.

3 When the iPhone is in standby or playing music, press and hold the button on the right unit to activate Siri.

Siri is activated and you will hear the start-up sound.

4 Make a request to Siri through the headset's microphone.

For details on Siri, such as apps which work with Siri, refer to the operating instructions of the iPhone.

5 To continue to request, press the button on the right unit before Siri is deactivated.

* After activating Siri, when a certain time has passed without requests, a beep will sound and Siri will be deactivated.

Note

- Siri cannot be activated when you say "Hey Siri" through the headset's microphone even when the iPhone's [Allow "Hey Siri"] setting is on.

Wireless Noise Canceling Stereo Headset
WF-1000X

What you can do with "Sony | Headphones Connect" app

When you connect the smartphone (installed with the "Sony | Headphones Connect" app) and the headset via the BLUETOOTH function, you can do the following.

- Display the remaining battery of the headset
- Display the BLUETOOTH connection codec
- Turn noise canceling on/off
- Use auto adjustment of the noise canceling function by behavior recognition
- Set the Ambient Sound mode
- Switch the sound quality mode by setting the BLUETOOTH connection mode
- Check the headset's status of connection/settings

For details of the "Sony | Headphones Connect" app, refer to the following URL.

http://rd1.sony.net/help/mdr/hpc/h_zz/

Hint

- The operation of the "Sony | Headphones Connect" app depends on audio devices. The app specifications and screen design may be changed without prior notice.

Related Topic

- [Installing "Sony | Headphones Connect" app](#)
- [Checking the remaining battery charge](#)
- [Using the noise canceling function](#)
- [Listening to ambient sound during music playback \(Ambient Sound Mode\)](#)
- [About the sound quality mode](#)
- [Supported codecs](#)

Installing "Sony | Headphones Connect" app

- 1 Download the "Sony | Headphones Connect" app from Google Play store or App Store, and install the app to your smartphone.

For details of the "Sony | Headphones Connect" app, refer to the following URL.
http://rd1.sony.net/help/mdr/hpc/h_zz/

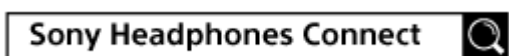

- 2 After installing the app, launch the "Sony | Headphones Connect" app.
-

Related Topic

- [What you can do with "Sony | Headphones Connect" app](#)

Wireless Noise Canceling Stereo Headset
WF-1000X

What you can do with "Sony | Music Center" app

When you connect the smartphone (installed with the "Sony | Music Center" app) and the headset via the BLUETOOTH function, you can do the following.

- Adjust the volume
- Display the remaining battery of the headset

For details of the "Sony | Music Center" app, refer to the following URL.

<http://info.vssupport.sony.net/help/>

Hint

- The operation of the "Sony | Music Center" app depends on audio devices. The app specifications and screen design may be changed without prior notice.

Related Topic

- [Installing "Sony | Music Center" app](#)
- [Checking the remaining battery charge](#)
- [Listening to music from a device via BLUETOOTH connection](#)
- [Controlling the audio device \(BLUETOOTH connection\)](#)

Wireless Noise Canceling Stereo Headset
WF-1000X

Installing "Sony | Music Center" app

- 1 Download the "Sony | Music Center" app from Google Play store or App Store, and install the app to your smartphone.

For details of the "Sony | Music Center" app, refer to the following URL.
<http://info.vssupport.sony.net/help/>



Music Center 

- 2 After installing the app, launch the "Sony | Music Center" app.
-

Related Topic

- [What you can do with "Sony | Music Center" app](#)

Precautions

On BLUETOOTH communications

- BLUETOOTH wireless technology operates within a range of about 10 m (30 feet). Maximum communication range may vary depending on obstacles (human body, metal, wall, etc.) or electromagnetic environment.
- Microwaves emitting from a BLUETOOTH device may affect the operation of electronic medical devices. Turn off this headset and other BLUETOOTH devices in the following locations, as it may cause an accident:
 - where inflammable gas is present, in a hospital, or a petrol station
 - near automatic doors or a fire alarm.
- Do not use the headset on an airplane. Radio waves may affect instruments, causing an accident due to malfunction.
- Due to the characteristic of the wireless technology, the sound played on this headset is delayed from the sound and music played on the sending device. Therefore, the image and sound may be misaligned when viewing a movie or playing a game.
- This headset supports security capabilities that comply with the BLUETOOTH standard to provide a secure connection when the BLUETOOTH wireless technology is used, but security may not be enough depending on the setting. Be careful when communicating using BLUETOOTH wireless technology.
- We do not take any responsibility for the leakage of information during BLUETOOTH communications.
- Connection with all BLUETOOTH devices cannot be guaranteed.
 - A device featuring BLUETOOTH function is required to conform to the BLUETOOTH standard specified by Bluetooth SIG, Inc. and be authenticated.
 - Even if the connected device conforms to the above mentioned BLUETOOTH standard, some devices may not be connected or work correctly, depending on the features or specifications of the device.
 - While talking on the phone hands free, noise may occur, depending on the device or communication environment.
- Depending on the device to be connected, it may require some time to start communications.

Note on static electricity

- Static electricity accumulated in the body may cause mild tingling in your ears. To minimize the effect, wear clothes made from natural materials.

Others

- Do not place this headset in a place exposed to humidity, dust, soot or steam, or subject to direct sunlight. Do not leave the headset in a car for a long time. It may cause a malfunction.
- Using the BLUETOOTH device may not function on mobile phones, depending on radio wave conditions and location where the device is being used.
- Listening with this headset at high volume may affect your hearing.
- For traffic safety, do not use this headset while driving or cycling.
- Do not put weight or pressure on this headset as it may cause the headset to deform during long storage.
- Do not use the headset in places where it would be dangerous if you are unable to hear ambient sound, such as at railroad crossings, train station platforms, pedestrian crossings, and construction sites.
- Do not subject the headset to excessive shock.
- Clean the headset with a soft dry cloth.
- Do not expose the headset to water. The headset is not waterproof. Remember to follow the precautions below.
 - Be careful not to drop the headset into a sink or other container filled with water.
 - Do not use the headset in humid locations or bad weather, such as in the rain or snow.
 - Do not get the headset wet. If you touch the headset with wet hands, or put the headset in a damp article of clothing, the headset may get wet and this may cause a malfunction of the headset.

- If you experience discomfort after using the BLUETOOTH device, stop using the BLUETOOTH device immediately. Should any problem persist, consult your nearest Sony dealer.
- Install the earbuds firmly. If an earbud accidentally detaches and is left in your ear, it may cause injury.
- Since children may swallow small parts such as the headset and earbuds, store the headset in the charging case after use and keep it out of the reach of children.
- If you have any questions or problems concerning this headset that are not covered in this manual, please consult your nearest Sony dealer.

4-724-045-11(2) Copyright 2017 Sony Corporation

Trademarks

- The Bluetooth® word mark and logos are registered trademarks owned by the Bluetooth SIG, Inc. and any use of such marks by Sony Corporation is under license.
- The N-Mark is a trademark or registered trademark of NFC Forum, Inc. in the United States and in other countries.
- Android and Google Play are trademarks of Google Inc.
- Windows is a registered trademark or trademark of Microsoft Corporation in the United States and/or other countries.
- Mac, OS X, iPhone, iPod touch and Siri are trademarks of Apple Inc., registered in the U.S. and other countries. App Store is a service mark of Apple Inc., registered in the U.S. and other countries.
- “Made for iPod” and “Made for iPhone” mean that an electronic accessory has been designed to connect specifically to iPod or iPhone, respectively, and has been certified by the developer to meet Apple performance standards. Apple is not responsible for the operation of this device or its compliance with safety and regulatory standards. Please note that the use of this accessory with iPod or iPhone may affect wireless performance.
- IOS is a trademark or registered trademark of Cisco in the U.S. and other countries and is used under license.

Other trademarks and trade names are those of their respective owners.

Wireless Noise Canceling Stereo Headset
WF-1000X

Customer support websites

Please access the following support website to get the support information about your headset:

For customers in the U.S.A:

<http://esupport.sony.com/>

For customers in Canada:

<http://esupport.sony.com/CA/>

For customers in Latin America:

<http://esupport.sony.com/LA/>

For customers in European countries:

www.sony.eu/support

For customers in China:

<https://service.sony.com.cn/>

For customers in other countries/regions:

<http://www.sony-asia.com/>

Wireless Noise Canceling Stereo Headset
WF-1000X

What can I do to solve a problem?

If the headset does not function as expected, try the following steps to resolve the issue.

- Find the symptoms of the issue in this Help Guide, and try any corrective actions listed.
- Connect the headset to a computer to charge the battery or reset.
You may be able to resolve some issues by charging the battery. The headset is reset automatically when the charging starts.
- Initialize the headset.
This operation resets the headset to the factory settings and deletes all pairing information.
- Look up information on the issue on the customer support website.

If the operations above do not work, consult your nearest Sony dealer.

Related Topic

- [Charging the headset](#)
- [Customer support websites](#)
- [Resetting the headset](#)
- [Initializing the headset to restore factory settings](#)

Wireless Noise Canceling Stereo Headset
WF-1000X

The headset is not turned on.

- Charge the battery of the headset.
-

Related Topic

- [Charging the headset](#)
- [Checking the remaining battery charge](#)

Wireless Noise Canceling Stereo Headset
WF-1000X

Charging cannot be done.

- Make sure that the headset is set on the charging case securely.
 - Check that you are using the micro-USB cable supplied.
 - Check that the micro-USB cable is connected to the charging case and the computer firmly.
 - Check that the computer is turned on.
 - Check that the computer is not in standby, sleep or hibernation mode.
 - When using Windows 8.1, update using Windows Update.
-

Related Topic

- [Charging the headset](#)

Wireless Noise Canceling Stereo Headset
WF-1000X

Charging time is too long.

- Check that charging case and the computer are directly connected, not via a USB hub.
-
-

Related Topic

- [Charging the headset](#)

4-724-045-11(2) Copyright 2017 Sony Corporation

Wireless Noise Canceling Stereo Headset
WF-1000X

The charging case cannot be recognized by a computer.

- The micro-USB cable is not connected properly to the USB port of the computer. Connect the micro-USB cable again.
- Check that the charging case and the computer are directly connected, not via a USB hub.
- A problem may have occurred with the connected USB port of the computer. Connect to another USB port if it is available.
- Try the USB connection procedure again in cases other than those stated above.
- Check that you are using the micro-USB cable supplied.

Wireless Noise Canceling Stereo Headset
WF-1000X

The remaining battery charge of the headset is not displayed on the screen of an iPhone or iPod touch.

-
- The remaining battery charge is shown only on the screen of an iPhone or iPod touch (iOS 5.0 or later) that supports HFP (Hands-free Profile).
 - Make sure that the iPhone or iPod touch is connected with HFP (Hands-free Profile). Otherwise, the remaining battery charge will not be displayed correctly.
-

Related Topic

- [Checking the remaining battery charge](#)

Wireless Noise Canceling Stereo Headset
WF-1000X

No sound

- Depending on the smartphone app (which requires HFP (Hands-free Profile)/HSP (Headset Profile)), you will hear a voice from the left unit only, but you may not be able to hear a voice from the right unit.
 - Check that the connected device and both the right and left units of the headset are turned on.
 - An A2DP BLUETOOTH connection is not made between the headset and the BLUETOOTH device. Use the BLUETOOTH device and make an A2DP BLUETOOTH connection.
 - If the volume is too low, turn up the volume.
 - Check that the connected device is playing back.
 - Pair the headset and the BLUETOOTH device again.
-

Related Topic

- [How to make a wireless connection to BLUETOOTH devices](#)
- [Listening to music from a device via BLUETOOTH connection](#)

Wireless Noise Canceling Stereo Headset
WF-1000X

Low sound level

- Turn up the volume of the connected device.

4-724-045-11(2) Copyright 2017 Sony Corporation

Low sound quality

- Turn down the volume of the connected device.
- Keep the headset away from a microwave oven, Wi-Fi device, etc.
- Bring the headset and the BLUETOOTH device closer together. Remove any obstacles between the headset and the BLUETOOTH device.
- Keep the headset away from a TV.
- Switch the BLUETOOTH connection to A2DP by operating the BLUETOOTH device when HFP or HSP is set.
- If you connect a device with a built-in radio or tuner to the headset, broadcasts may not be received, or sensitivity may be reduced. Locate the headset farther away from the device and check that you can listen to the broadcasts satisfactorily.
- If you have previously connected the headset to this BLUETOOTH device, only an HFP/HSP BLUETOOTH connection may be made when the headset is turned on. If this happens, use the BLUETOOTH device and make an A2DP BLUETOOTH connection.

Sound skips frequently during playback.

- Set the headset to the “Priority on stable connection” mode. For details, refer to [“About the sound quality mode.”](#)
- Remove any obstacles between the antenna of the BLUETOOTH device to be connected and the built-in antenna of the headset. The antenna of the headset is built into the part shown in the dotted line below.

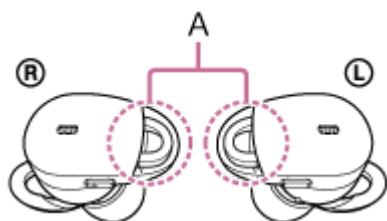

A: Location of the built-in antenna

- BLUETOOTH communications may be disabled, or noise or audio dropout may occur under the following conditions.
 - There is a human body between the headset and the BLUETOOTH device. This situation may be improved by placing the BLUETOOTH device facing the antenna of the headset.
 - There is an obstacle, such as metal or wall, between the headset and the BLUETOOTH device.
 - A device using 2.4 GHz frequency, such as a Wi-Fi device, cordless telephone, or microwave oven, is in use near this headset.
- The situation may be improved by changing the wireless playback quality settings or fixing the wireless playback mode to SBC on the transmitting device. For details, refer to the operating instructions supplied with the transmitting device.
- Because BLUETOOTH devices and Wi-Fi (IEEE802.11b/g/n) use the same frequency (2.4 GHz), microwave interference may occur resulting in noise or audio dropout or communications being disabled if this headset is used near a Wi-Fi device. In such a case, perform the following.
 - Use this headset at least 10 m (30 feet) away from the Wi-Fi device.
 - If this headset is used within 10 m (30 feet) of a Wi-Fi device, turn off the Wi-Fi device.
 - Install this headset and the BLUETOOTH device as near to each other as possible.
- In case that you enjoy music with your smartphone, the situation may be improved by shutting down unnecessary apps or restarting your smartphone.

Wireless Noise Canceling Stereo Headset
WF-1000X

The noise canceling effect is not sufficient.



- Make sure that the noise canceling function is turned on.
 - Adjust the earpad position to fit your ears.
 - The noise canceling function is effective in low frequency ranges such as airplanes, trains, offices, near air-conditioning, and is not as effective for higher frequencies, such as human voices.
-
-

Related Topic

- [What is noise canceling?](#)
- [Using the noise canceling function](#)

Wireless Noise Canceling Stereo Headset
WF-1000X

Pairing cannot be done.

- Bring the headset and the BLUETOOTH device within 1 m(3 feet) from each other.
 - When you turn on the headset for the first time after purchasing, initializing, or repairing it, the headset enters pairing mode automatically. Pair the headset with a BLUETOOTH device. When you want to pair a 2nd or subsequent device, press and hold the  button on the  left unit of the headset for more than 7 seconds to enter pairing mode.
 - When you pair the headset with devices again after initializing or repairing the headset, information for pairing with the headset remaining on the iPhone or other device may prevent you from pairing them successfully. In this case, delete the pairing information of the headset from the device, and then pair them again.
-

Related Topic

- [About the indicator](#)
- [How to make a wireless connection to BLUETOOTH devices](#)
- [Initializing the headset to restore factory settings](#)

Wireless Noise Canceling Stereo Headset
WF-1000X

Unable to connect the headset to a BLUETOOTH device with one-touch connection (NFC)

- Remove the headset from the charging case and make sure that the headset is turned on.
 - Keep the smartphone close to the charging case until the smartphone reacts. If you fail to connect, move the smartphone slowly on the N-Mark of the charging case.
 - Check that the NFC function of the smartphone is set to on.
 - If the smartphone is in a case, remove it.
 - NFC reception sensitivity varies depending on the device. If you repeatedly fail to connect the headset with a smartphone by one touch, connect it to the headset by on-screen operation on the smartphone.
 - You cannot make a one-touch connection (NFC) while charging the battery because the headset cannot be turned on. Finish charging first, and then make the one-touch connection (NFC).
-

Related Topic

- [One-touch connection \(NFC\) with a smartphone \(Android 4.1 or later\)](#)

Unable to make a BLUETOOTH connection

- Check that the headset is turned on.
 - Check that the BLUETOOTH device is turned on and the BLUETOOTH function is on.
 - If the headset automatically connects to the last connected BLUETOOTH device, you may fail to connect the headset to other devices via the BLUETOOTH function.
In that case, operate the last connected BLUETOOTH device and disconnect the BLUETOOTH connection.
 - The BLUETOOTH device is in sleep mode. Cancel the sleep mode.
 - The BLUETOOTH connection is terminated. Make the BLUETOOTH connection again.
 - In case that the pairing information for the headset has been deleted on the connected device, pair the headset with the device again.
-

Related Topic

- [About the indicator](#)
- [How to make a wireless connection to BLUETOOTH devices](#)

Wireless Noise Canceling Stereo Headset
WF-1000X

Distorted sound

- Keep the headset away from a microwave oven, Wi-Fi device, etc.

4-724-045-11(2) Copyright 2017 Sony Corporation

The BLUETOOTH wireless communication range is short, or the sound skips.

- Set the headset to the “Priority on stable connection” mode. For details, refer to [“About the sound quality mode.”](#)
- Remove any obstacles between the antenna of the BLUETOOTH device to be connected and the built-in antenna of the headset. The antenna of the headset is built into the part shown in the dotted line below.

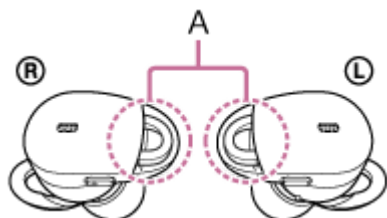

A: Location of the built-in antenna

- BLUETOOTH communications may be disabled, or noise or audio dropout may occur under the following conditions.
 - There is a human body between the headset and the BLUETOOTH device. This situation may be improved by placing the BLUETOOTH device facing the antenna of the headset.
 - There is an obstacle, such as metal or wall, between the headset and the BLUETOOTH device.
 - A device using 2.4 GHz frequency, such as a Wi-Fi device, cordless telephone, or microwave oven, is in use near this headset.
- The situation may be improved by changing the wireless playback quality settings or fixing the wireless playback mode to SBC on the transmitting device. For details, refer to the operating instructions supplied with the transmitting device.
- Because BLUETOOTH devices and Wi-Fi (IEEE802.11b/g/n) use the same frequency (2.4 GHz), microwave interference may occur resulting in noise or audio dropout or communications being disabled if this headset is used near a Wi-Fi device. In such a case, perform the following.
 - Use this headset at least 10 m (30 feet) away from the Wi-Fi device.
 - If this headset is used within 10 m (30 feet) of a Wi-Fi device, turn off the Wi-Fi device.
 - Install this headset and the BLUETOOTH device as near to each other as possible.
- In case that you enjoy music with your smartphone, the situation may be improved by shutting down unnecessary apps or restarting your smartphone.

Wireless Noise Canceling Stereo Headset
WF-1000X

The headset does not operate properly.

- Reset the headset. Pairing information is not deleted by this operation.
 - If you cannot use the headset even after resetting it, initialize the headset.
-
-

Related Topic

- [Resetting the headset](#)
- [Initializing the headset to restore factory settings](#)

Wireless Noise Canceling Stereo Headset
WF-1000X

No voice from callers

- Check that both the headset and the connected device (i.e., smartphone) are turned on.
 - Turn up the volume of the connected device (i.e., smartphone).
 - Check that output of the BLUETOOTH device is set for the headset.
 - Select an HFP or HSP BLUETOOTH connection by operating the BLUETOOTH device.
 - If you are listening to music using the headset, stop playback, press the button on the left or right unit and talk.
-

Related Topic

- [How to make a wireless connection to BLUETOOTH devices](#)
- [Receiving a call](#)
- [Making a call](#)

Wireless Noise Canceling Stereo Headset
WF-1000X

Low voice from callers

- Turn up the volume of the connected device.

4-724-045-11(2) Copyright 2017 Sony Corporation

Wireless Noise Canceling Stereo Headset
WF-1000X

Resetting the headset

If the headset cannot be turned on, or if it cannot be operated even when it is turned on, reset the headset. When the charging starts, the indicator (red) of the headset turns off after 10 seconds then the headset is reset automatically. Pairing information and other settings are not deleted by this operation.

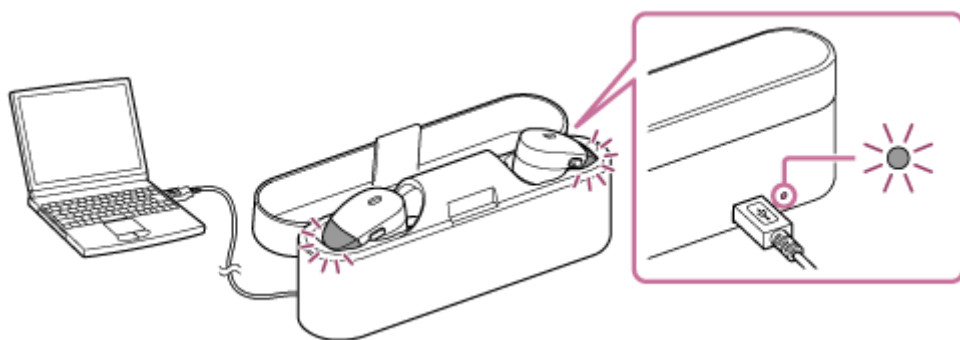



If the headset does not operate correctly even after resetting, initialize the headset to restore factory settings.

Related Topic

- [Initializing the headset to restore factory settings](#)

Wireless Noise Canceling Stereo Headset
WF-1000X

Initializing the headset to restore factory settings

Remove the headset from the charging case to turn off the headset by pressing and holding the  button on the left unit for more than 2 seconds, then press and hold both the button on the right unit and the  button on the left unit for more than 15 seconds.

The indicator (red) goes into the flashing state then the indicator (blue) flashes 4 times (● ● ● ●), and the headset is reset to the factory settings. All pairing information is deleted. In this case, delete the pairing information for the headset on the device which has been connected, then pair the headset with the device again.

If the headset does not operate correctly even after initializing, consult your nearest Sony dealer.