

## **TeraStation 5000 User Manual**

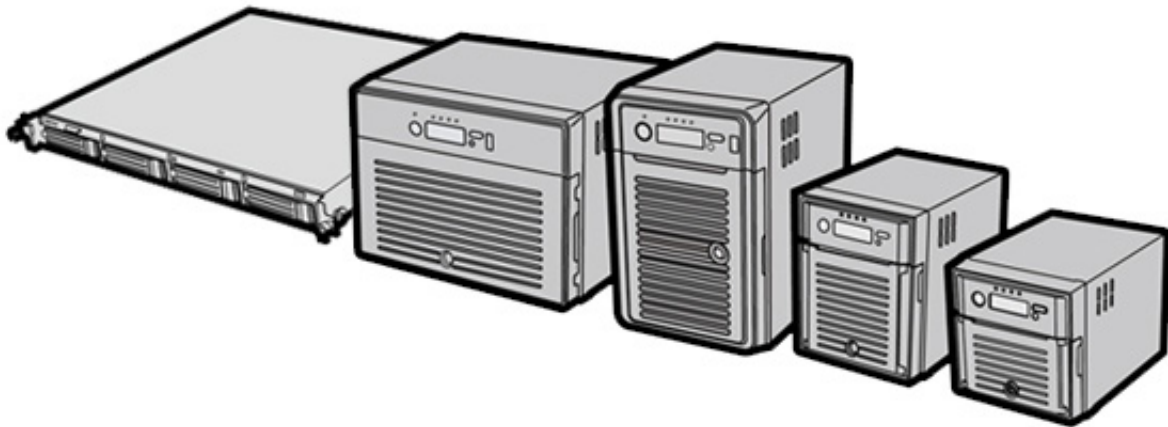

***[www.buffalotech.com](http://www.buffalotech.com)***

35020018-01

# Contents

<b>Chapter 1 Installation.....</b>	<b>10</b>
Installation.....	10
Turning the TeraStation On and Off.....	13
Changing the Administrator Password .....	15
Recovery Drive .....	17
For Initializing Settings .....	17
For Password Resetting .....	17
<b>Chapter 2 Configuration .....</b>	<b>19</b>
Opening Settings .....	19
Opening Easy Admin .....	20
<b>Chapter 3 Access Restrictions.....</b>	<b>22</b>
Configuring Access Restrictions on Users and Groups .....	22
Adding a Shared Folder.....	22
Notes .....	24
Adding Users .....	25
Adding Groups .....	27
Access Restrictions.....	28
Active Directory .....	30
NT Domains .....	31
Delegating Authority to an External SMB Server .....	33

<b>Chapter 4 Managing your Storage .....</b>	<b>36</b>
<b>RAID Arrays.....</b>	<b>36</b>
<b>Working with RAID Arrays .....</b>	<b>38</b>
Using JBOD .....	38
Changing RAID Mode .....	38
Configuring a Hot Spare .....	39
RMM (RAID Mode Manager).....	40
RAID Scanning.....	42
<b>Adding an External Hard Drive .....</b>	<b>43</b>
<b>Dismounting Drives .....</b>	<b>44</b>
<b>Checking Drives .....</b>	<b>45</b>
<b>Formatting Drives .....</b>	<b>46</b>
<b>Encrypting Drives.....</b>	<b>47</b>
<b>Media Cartridges.....</b>	<b>48</b>
<b>Erase Data on the TeraStation Completely.....</b>	<b>48</b>
<b>Disk Quotas .....</b>	<b>49</b>
Quotas for Users.....	49
Quotas for Groups .....	50
Size Limits.....	50
<b>Using the TeraStation as an iSCSI Device .....</b>	<b>54</b>
Introduction .....	54
Using the iSCSI Connection Tool.....	57
Creating and Expanding Volumes .....	60
Setting Access Restrictions .....	61
<b>Hard Drive Replacement .....</b>	<b>63</b>

Hard Drive Replacement Examples .....	64
<b>Chapter 5 Backup .....</b>	<b>72</b>
Back Up from the TeraStation .....	72
Preparing a Backup Destination.....	72
Configuring a Backup Job .....	74
Replication.....	77
Failover .....	78
Ethernet cable connection methods: .....	79
Backing Up Your Mac with Time Machine .....	81
Copy from a USB Device .....	85
Amazon S3 .....	86
<b>Chapter 6 Remote Access .....</b>	<b>88</b>
WebAccess .....	88
Configuration .....	88
WebAccess Remote .....	91
FTP.....	92
<b>Chapter 7 BitTorrent.....</b>	<b>95</b>
Configuration .....	95
<b>Chapter 8 Multimedia .....</b>	<b>97</b>
DLNA .....	97

<b>Configuration .....</b>	<b>97</b>
<b>Playing Files .....</b>	<b>99</b>
<b>Connected DLNA-compatible Devices .....</b>	<b>99</b>
<b>Streaming to DLNA-compatible Devices .....</b>	<b>100</b>
<b>Disabling Playback from Specific Devices .....</b>	<b>101</b>
<b>iTunes Server .....</b>	<b>102</b>
<b>Squeezebox Server .....</b>	<b>103</b>

## **Chapter 9 Surveillance Server ..... 105**

<b>Getting Started .....</b>	<b>105</b>
<b>Installing Client Tools .....</b>	<b>106</b>
<b>Connecting Devices to the Network.....</b>	<b>106</b>
<b>Enabling Surveillance Cameras .....</b>	<b>107</b>
<b>Enabling the Free License .....</b>	<b>108</b>
<b>Registering Recording Policies .....</b>	<b>110</b>
<b>Checking Recording.....</b>	<b>113</b>
<b>Email Error Notification.....</b>	<b>114</b>
<b>Configuration .....</b>	<b>114</b>
<b>Viewing Saved Video .....</b>	<b>114</b>
<b>Export Recorded Data as a MOV Video File .....</b>	<b>115</b>
<b>Viewing Video Real-time .....</b>	<b>117</b>
<b>Moving Recorded Video Data to Another TeraStation.....</b>	<b>117</b>
<b>Backing Up Recorded Video to Another TeraStation .....</b>	<b>118</b>
<b>Automatically Delete Old Data when Space is Low.....</b>	<b>119</b>
<b>Changing Where Recorded Video Is Saved .....</b>	<b>121</b>
<b>Client Utilities .....</b>	<b>121</b>
<b>Camera Policies .....</b>	<b>121</b>

Live Viewer .....	122
Data Service Policies.....	123
Vault Admin.....	123
Surveillance Video Manager .....	124
Network Activity .....	125
Mini Vault Stats .....	125
<b>Activating Additional Licenses .....</b>	<b>126</b>
When the TeraStation is Connected to the Internet.....	126
TeraStation Not Connected to the Internet .....	128
<b>Troubleshooting.....</b>	<b>131</b>

## **Chapter 10 Advanced Features .....132**

<b>Antivirus Software .....</b>	<b>132</b>
Activating Virus Scanning .....	132
Configuring Security Settings .....	132
Connecting through a Proxy Server .....	133
Licenses .....	134
Updating.....	135
Excluding a Specific Folder from Antivirus Scanning .....	136
Virus Scanning .....	137
Checking the Log .....	137
Online Help.....	138
<b>Email Notification .....</b>	<b>139</b>
<b>Sleep Mode .....</b>	<b>140</b>
<b>Wake-on-LAN .....</b>	<b>142</b>
<b>UPS (Uninterruptible Power Supply).....</b>	<b>143</b>

<b>Port Trunking.....</b>	<b>144</b>
<b>Connecting a Printer .....</b>	<b>145</b>
<b>Setting Up a Printer with Windows 8, Windows 7, or Windows Vista....</b>	<b>145</b>
<b>Setting Up a Printer with Windows XP .....</b>	<b>146</b>
<b>TeraSearch .....</b>	<b>147</b>
<b>Offline Files.....</b>	<b>149</b>
<b>DFS .....</b>	<b>152</b>
<b>Accessing from a NFS Client .....</b>	<b>153</b>
<b>Encrypting Data Transmission .....</b>	<b>156</b>
<b>Encrypting Settings Data .....</b>	<b>156</b>
<b>Encrypting FTP Transfer Data .....</b>	<b>156</b>
<b>SSL Keys .....</b>	<b>156</b>
<b>Web Server.....</b>	<b>157</b>
<b>MySQL Server .....</b>	<b>158</b>
<b>SNMP .....</b>	<b>159</b>
<b>Saving and Applying Settings.....</b>	<b>159</b>
<b>Saving Settings .....</b>	<b>160</b>
<b>Applying Settings .....</b>	<b>161</b>
<b>Restoring Factory Defaults.....</b>	<b>161</b>
<b>Initializing from Settings .....</b>	<b>161</b>
<b>Creating an Initialization Drive.....</b>	<b>162</b>
<b>Initializing with the USB Drive.....</b>	<b>162</b>
<b>Resetting the Administrator Password .....</b>	<b>163</b>
<b>Creating a Password Reset Drive .....</b>	<b>163</b>
<b>Resetting with the USB Drive.....</b>	<b>163</b>

<b>Logs .....</b>	<b>164</b>
<b>Updating the Firmware.....</b>	<b>165</b>
<b>Name, Date, Time, and Language .....</b>	<b>166</b>
<b>Beep Alerts .....</b>	<b>167</b>
<b>LCD and LEDs.....</b>	<b>168</b>
<b>Jumbo Frames .....</b>	<b>169</b>
<b>Changing the IP Address .....</b>	<b>170</b>

## **Chapter 11 Utilities.....172**

<b>NAS Navigator2 for Windows .....</b>	<b>172</b>
<b>Mount as Network Drive.....</b>	<b>174</b>
<b>NAS Navigator2 for Mac .....</b>	<b>175</b>
<b>Mount as Network Drive.....</b>	<b>175</b>
<b>iSCSI Connection Tool .....</b>	<b>176</b>
<b>Menu .....</b>	<b>177</b>

## **Chapter 12 Appendix .....179**

<b>Diagrams.....</b>	<b>179</b>
<b>TS5800D .....</b>	<b>179</b>
<b>TS5600D .....</b>	<b>179</b>
<b>TS5400D .....</b>	<b>179</b>
<b>TS5200D .....</b>	<b>180</b>
<b>TS5400R.....</b>	<b>180</b>
<b>LCD Display.....</b>	<b>182</b>
<b>Modes .....</b>	<b>182</b>



<b>Errors</b> .....	<b>182</b>
<b>Status</b> .....	<b>183</b>
<b>Default Settings</b> .....	<b>186</b>
<b>Specifications</b> .....	<b>186</b>
<b>Compliance Information</b> .....	<b>188</b>
<b>FCC Warning</b> .....	<b>188</b>
<b>CE Mark Warning</b> .....	<b>188</b>
<b>Environmental Information</b> .....	<b>188</b>
<b>KC</b> .....	<b>188</b>
<b>BSMI</b> .....	<b>189</b>
<b>CCC</b> .....	<b>189</b>
<b>电池警告语</b> .....	<b>189</b>
<b>Models</b> .....	<b>189</b>

# Chapter 1 Installation

## Installation

- 1 Insert the TeraNavigator CD into your computer. TeraNavigator will launch.
- 2 Click *Begin Installation*.



- 3 Follow the steps on the screen to connect the TeraStation's Ethernet and power cables and turn it on.  
TS5800D

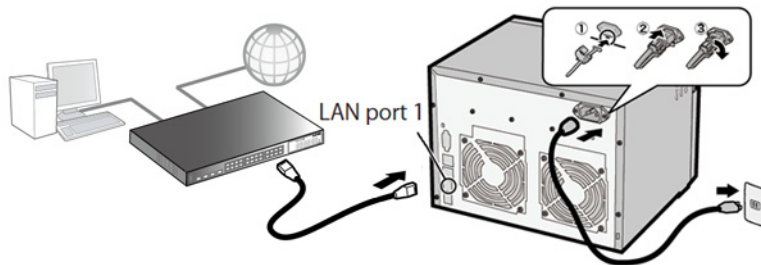

TS5600D

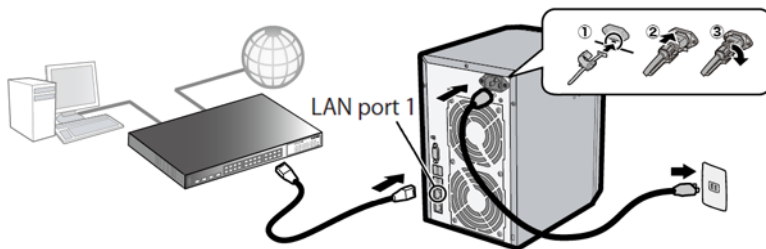

TS4400D

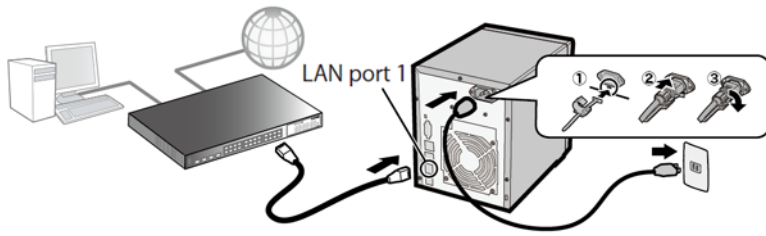

TS5200D

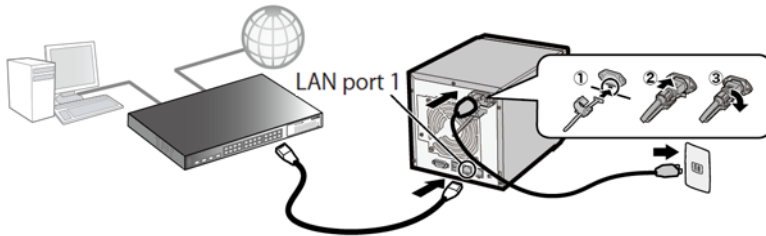

TS5400R

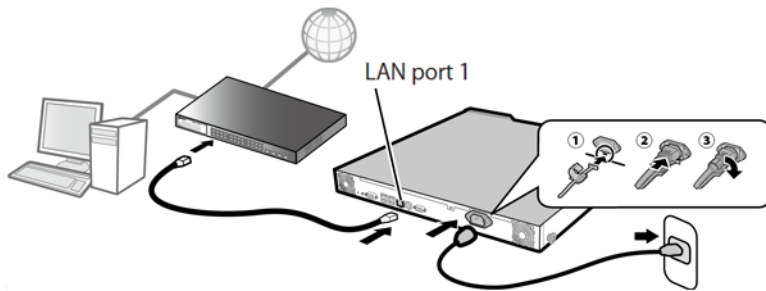

**Note:** Use LAN port 1 for initial setup. After setup, you may connect a second cable to LAN port 2. If you use LAN port 2, configure the IP address at *Network - IP Address* in Settings.

**4** Follow the steps on the screen to install NAS Navigator2.

**5** Click *Finish*.

NAS Navigator2 will open. You can also open it by clicking  in the Dock.

**6** Right-click on your TeraStation's icon and choose *Properties*.

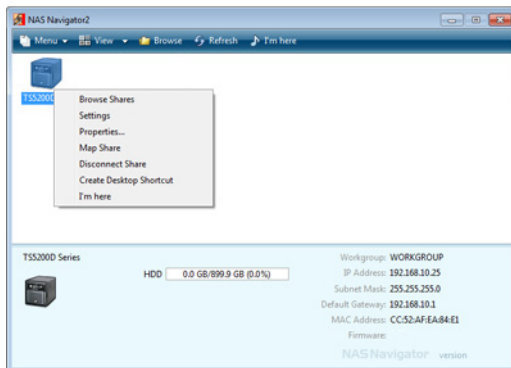

**Note:** For Mac OS, select the TeraStation icon while holding down the control key, then click *Configure*.

**7** Click the *IP Address* tab, enter the desired settings, and click *OK*.

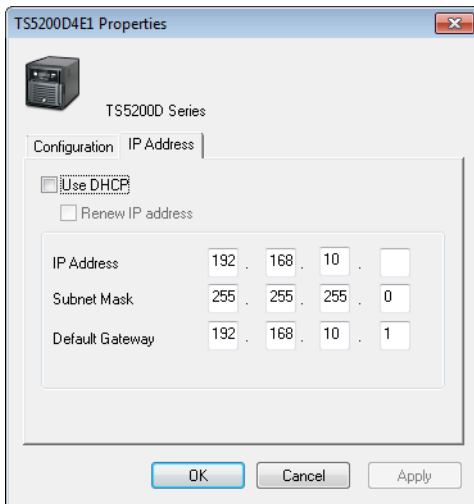

If you are prompted to enter the administrator password for the TeraStation, it is “password” by default.

- 8 Right-click on your TeraStation’s icon and choose *Settings*.

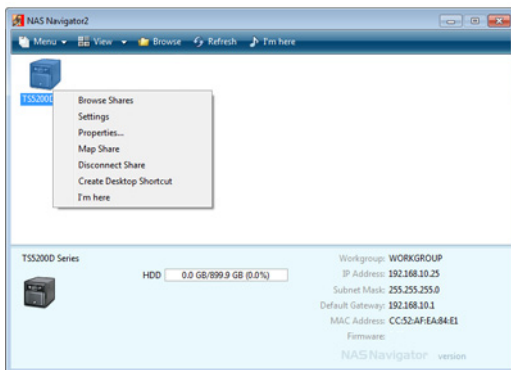

- 9 Changing the password from the default is recommended.

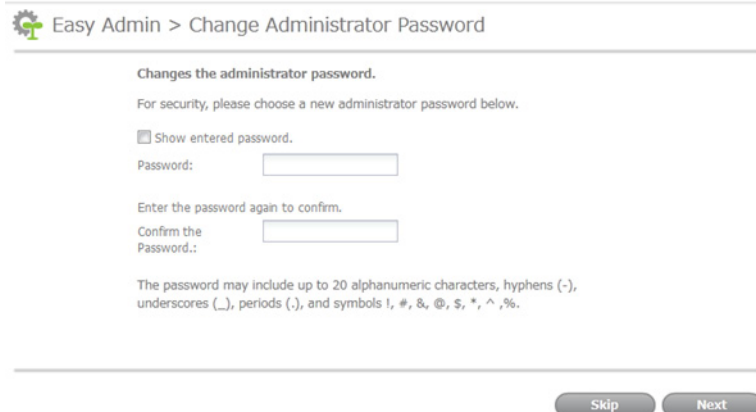

- 10 Go to *Management - Name/Time/Language* and configure the TeraStation’s time and date.

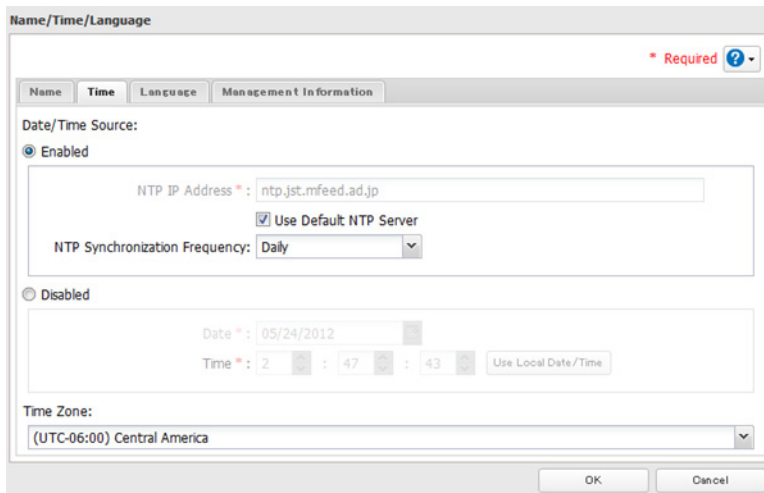

### Notes:

- For best results, use an NTP server to maintain the time settings on the TeraStation and other network devices. Clocks for the network devices may run at slightly different speeds. If these devices get out of sync it may cause network problems.
- Buffalo Technology is not responsible for any loss or damage caused by using the ntp.jst.mfeed.ad.jp service or service outages.
- If the TeraStation cannot automatically obtain the time from an NTP server, check its DNS settings. If the NTP server is specified by a hostname instead of an IP address, make sure that a DNS server address is configured in *Network - IP Address*.

**11** In NAS Navigator2, double-click your TeraStation's icon. This will open the shared folder of the TeraStation. For Mac OS, the TeraStation is mounted as a drive icon on the desktop or it is displayed in the sidebar of the Finder. You can now use the TeraStation's shared folder to save files just like any other folder.

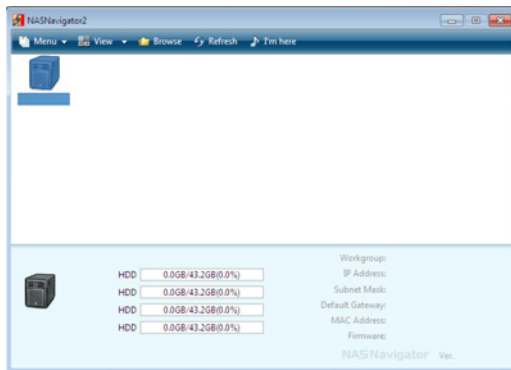

## Turning the TeraStation On and Off

Press the power button on the TeraStation to turn it on.

Because the TeraStation can be damaged if it is unplugged suddenly without powering it down properly, press the power button twice within 3 seconds to shut it down before unplugging it. You can also shut it down and restart it remotely from Settings.

## Shutdown or Restart from Settings:

- 1 Double-click the  icon on the desktop. NAS Navigator2 will start.

**Note:** For Mac OS, click the  icon in the Dock.

- 2 Right-click your TeraStation's icon and select *Settings*.

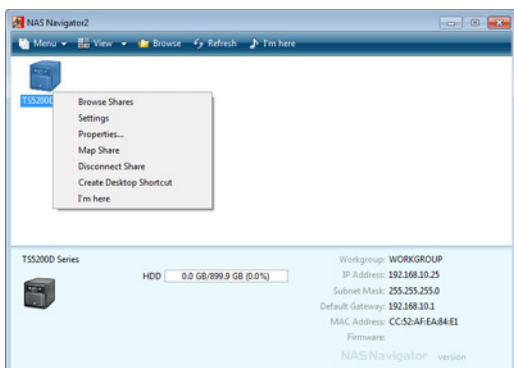

**Note:** For Mac OS, select the TeraStation icon while holding down the control key, then select *Settings*.

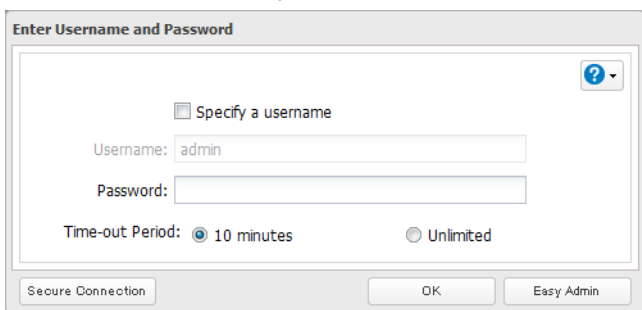

- 3 Enter the username and password, then click *OK*.



**Note:** The default username and password are "admin" and "password".

- 4 Settings will open.



- 5  Click  at the top-right of Settings and choose either *Restart* or *Shut Down*.

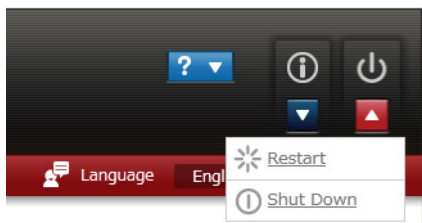

When all the LEDs on the front of the TeraStation turn off, the shutdown process is complete.

## Changing the Administrator Password

After initial setup, follow this procedure to change your password.

- 1 Double-click the  icon.  
NAS Navigator2 will start.
- 2 Right-click on your TeraStation's icon and select *Settings*. On the Mac, select the TeraStation's icon while holding down the control key, then select *Settings*.

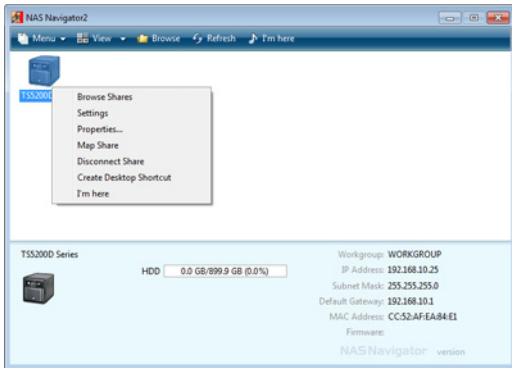

**3** Enter your username and password.

**4** Click *Change Password*.

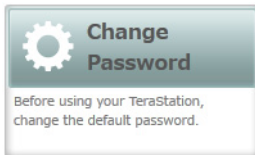

**5** Enter the new password (twice).

**6** Click *OK*. You have changed the admin password.



## Recovery Drive

To initialize all of the TeraStation's settings, or just restore the admin password to its factory default value, create the recovery drives as described below.

### For Initializing Settings

---

A system initialization drive can reset all settings to their default values.

**Notes:**

Normally, making and using the system initialization drive will not affect data. However, always back up your data regularly!

This USB drive can use to recover the system if your TeraStation doesn't boot at all. In this case, if the data partition is damaged, then all your data will be deleted by the recovery process.

- 1** In Settings, navigate to *Management-Restore/Erase-USB Options*.
- 2** Select *Create a USB drive for initializing settings*.
- 3** Insert a 1 GB or larger USB flash drive into a USB port on the TeraStation.

**Note:** Note:

All data on the USB flash drive will be erased!

- 4** Select the USB memory device from "Target USB drive", then click *Execute*.
- 5** Enter the 4 digit confirmation number and click *OK*. The TeraStation will create the initialization drive. This will take about a minute.
- 6** When the "finished" dialog opens, the USB initialization drive is ready to use. Dismount the USB drive before unplugging it. See "Dismounting Drives" in Chapter 4 for the instructions on dismounting drives.

### For Password Resetting

---

A password initialization drive can reset the administrator password to its default value ("password"). This could be very useful if you forget your admin password.

- 1** In Settings, navigate to *Management - Restore/Erase - USB Options*.
- 2** Select *Create a USB drive for resetting the admin password*.
- 3** Insert a 1 GB or larger USB memory device (not included) to a USB 2.0 port on the TeraStation.

**Note:** Note:

All data on the USB flash drive will be erased!

- 4** Select the USB memory device from "Target USB drive" list, then click *Execute*.
- 5** Enter the 4 digit confirmation number and click *OK*. The TeraStation will create the password reset drive. This will

take about a minute.

- 6** When the “finished” dialog opens, the password reset drive is ready to use. Dismount the USB drive before unplugging it. See “Dismounting Drives” in Chapter 4 for the instructions on dismounting drives.

For instructions on using system initialization or password initialization drives, see Chapter 10.

# Chapter 2 Configuration

Configure and administer your TeraStation using the Settings interface, accessible from a browser window. Open the interface using the procedure below or type the TeraStation's IP address in the URL field of your browser. Within Settings, the Easy Admin page gives you quick access to commonly used settings.

**Note:** Internet Explorer 9, Firefox 8, Google Chrome 15, Safari 5, and later are supported. If you have difficulty viewing Settings, check the following:

- If there are a large number of registered users, groups, or shared folders, use Firefox 8 or later instead of Internet Explorer.
- If you have a proxy server enabled in the browser settings, disable the proxy server.
- With Internet Explorer, set security to *Local intranet*. On Windows Server 2008, higher-level security is configured. Set the security to a lower level temporarily.

## Opening Settings

1 Double-click the  icon in the Dock.

2 Right-click on your TeraStation's icon in NAS Navigator and select *Settings*. For Mac OS, click your TeraStation's icon while holding down the control key, then select *Settings*.

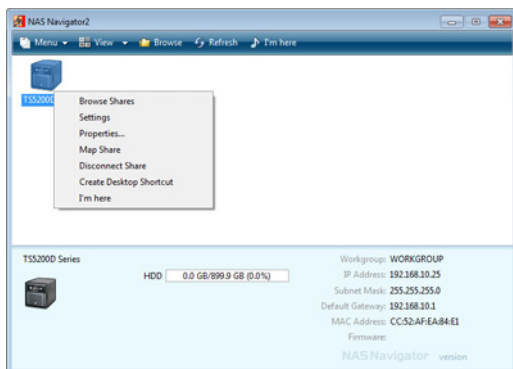

3 Enter the username and password and click *OK*.

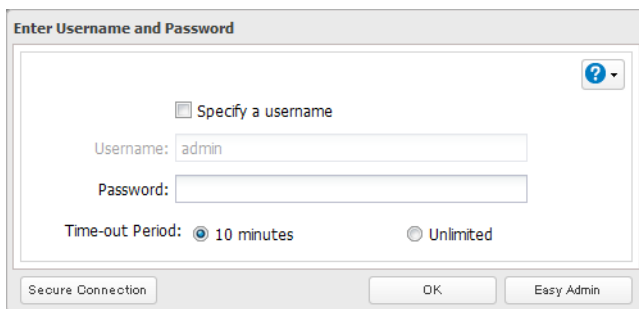
A screenshot of the "Enter Username and Password" dialog box. The dialog has a title bar "Enter Username and Password" and a help icon. It contains a checkbox labeled "Specify a username" which is checked. Below it, the "Username:" field contains the text "admin". The "Password:" field is empty. At the bottom, there are two radio buttons for "Time-out Period": "10 minutes" (selected) and "Unlimited". At the very bottom, there are three buttons: "Secure Connection", "OK", and "Easy Admin".

Username/Password Combinations:



Username	Password	Settings Available
admin	password	All
guest	blank	TeraStation name, IP address, workgroup, drive status, hardware version
your username	your password	TeraStation's name, IP address, workgroup, drive status, firmware version, and your password.

**Note:** If the time-out period is set to "10 minutes", you will be logged out of Settings after 10 minutes of inactivity.

#### 4 Settings will open.



#### Notes:

- Click  to open Easy Admin.
- Click  to play a tone from the TeraStation for easy location.
- You can also use Bonjour to log in to Settings from OS X 10.4 or later:  
In Safari, click *View - Show Bookmarks Bar*. From Bookmarks, click *Bonjour - TeraStation name*.

## Opening Easy Admin

Use the Easy Admin page to make common changes to basic settings.

- 1 Open NAS Navigator2 by double-clicking the  icon in the Dock if you have a Mac.
- 2 Right-click on your TeraStation's icon and choose *Settings*. For Mac OS, click the TeraStation icon while holding down the control key, then select *Settings*.

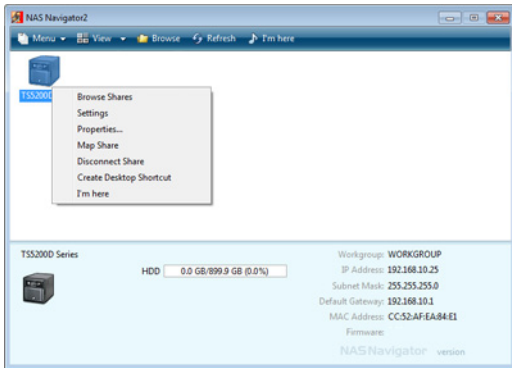

**3** Click *Easy Admin*.

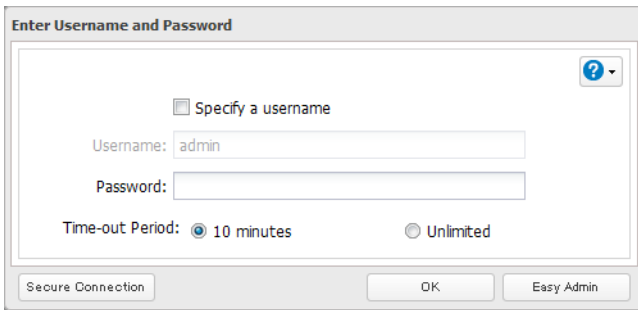

**4** The Easy Admin screen will open.

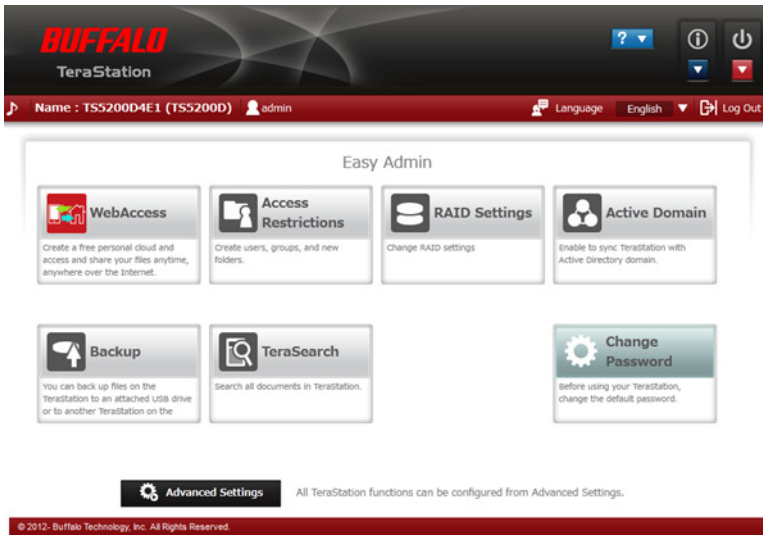

**Notes:**

- If you click any buttons , you will need to enter a username and password.
- You can open Easy Admin anytime by clicking the  icon at the top left of Settings.

# Chapter 3 Access Restrictions

You may restrict access to specific shared folders.

**Notes:**

- Access restrictions can be set separately for each shared folder, but not for folders within the shared folders.
- Configure access restrictions through Settings. Configuring access restrictions through Windows is not supported and may cause unexpected behavior.
- You can also configure users, groups, and shared folders from Easy Admin by clicking *Access Restrictions*.
- Shared folders with limited access can still be used as backup destinations.

## Configuring Access Restrictions on Users and Groups

### Adding a Shared Folder

---

- 1** In Settings, click the  icon to the right of "Folder Setup".



- 2** Click *Create Folder*.
- 3** Configure the settings, then click *OK*.

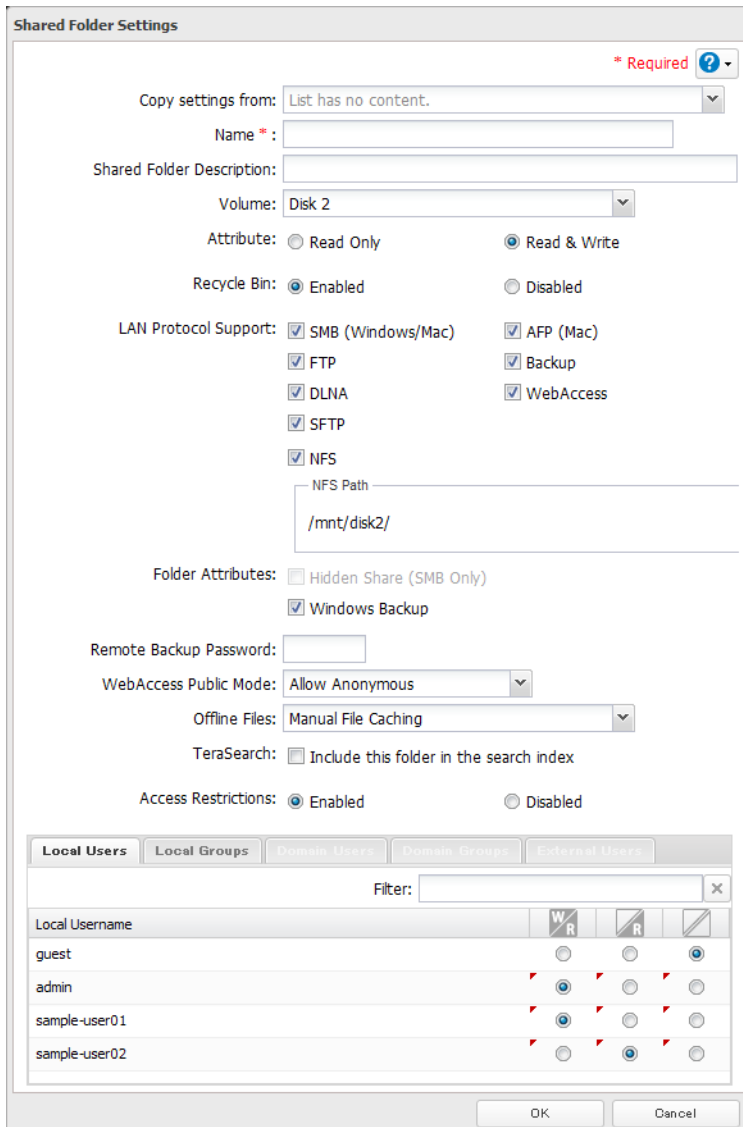

### Notes:

- Names may contain up to 27 alphanumeric characters, hyphens (-), and underscores (\_). Do not use a symbol as the first character in a name.
- The description may contain up to 75 alphanumeric characters, hyphens (-), underscores (\_), and spaces. Do not use a symbol or space as the first character.
- You may create up to 400 shared folders.
- The names of shared folders should not use characters from more than one language. For example, mixing Japanese and Korean characters in names is not supported.
- If multi-byte characters are used in shared folder names, configure the client language to match the characters in *Management - Name/Time/Language*.

## Recycle Bin

To protect your data from accidental deletion, you configure your TeraStation to use a recycle bin instead of deleting files immediately. The recycle bin will only work with SMB connections. To empty the recycle bin, click *File Sharing - Folder Setup - Empty the recycle bin* in Settings.

**Note:** You can prevent guests and other users from emptying the trash by navigating to *File Sharing - SMB -*





- Configure hidden and read-only file attributes in Settings. Configuring them from within Windows is not supported and may cause unexpected behavior.
- Folder and workgroup names whose names contain non-Roman characters may not be displayed correctly.
- If shared folders are accessed from a Macintosh, information files for the Macintosh may be generated automatically. Do not delete these files. If they are deleted using Windows, this may prevent further access from a Macintosh.
- If an SMB connection is used with OS X 10.3.9, the names of mounted volumes may appear as unreadable characters in Finder and other applications. This is not a problem with the filename or data.
- With OS X 10.5 to 10.5.6, Spotlight searches are not supported over AFP connections. Use SMB connections or upgrade to OS X 10.5.7 or later.
- The TeraStation belongs to the default zone in AppleShareServer; the zone cannot be specified.
- When files are copied to the TeraStation or to a USB drive connected to the TeraStation, file information such as date created, date modified, and other date information may be updated or changed.
- Hard drive capacity is shown in Settings in actual gigabytes. The Properties window of Windows may show GiB instead, which will be a smaller number.
- During a file transfer, if settings are changed, the file transfer operation may be aborted.
- File copying to the TeraStation is protected by a journaling file system.
- If the Ethernet cable is disconnected or a power outage occurs while copying data, the following may occur:
  - The preset data (TeraStation name, user, and group) may be erased.
  - An incomplete file may be copied and the file can no longer be deleted. If this happens, restart the TeraStation, delete the file, and perform the copy operation again.
- After a drive is formatted, the “% Used” and “Amount Used” in Settings will not be 0. This is because some drive space is used for the system area.
- To delete the contents of the trashbox folders for all shared folders, click *File Sharing - Folder Setup - Empty the recycle bin* in Settings.
- Do not set the same address for LAN port 1 and LAN port 2. This may cause unstable network communication.
- Use LAN port 1 to access different network subnets from the TeraStation. Access to a different network subnet is not possible from LAN port 2 since it doesn't have a default gateway.

## Adding Users

---

**1** In “File Sharing”, select *Users*.

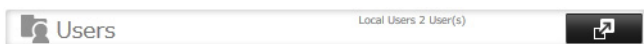

**2** Click *Create User*.

### 3 Enter the desired settings, then click *OK*.

#### Notes:

- Usernames may contain up to 20 characters, including hyphens (-), underscores (\_), periods (.), !, #, &, @, \$, \*, ^, and %. Do not use a symbol as the first character.
- The user ID should be a number from 1000 to 1999. Each user ID should be unique. If this field is left blank, a user ID is assigned automatically.
- The description may contain up to 75 alphanumeric characters, hyphens (-), underscores (\_), and spaces. Do not use a symbol or space as the first character.
- When setting users with access privileges, a maximum of 300 users can be registered in the TeraStation.
- Passwords may contain up to 20 alphanumeric characters and the following characters: - \_ @ ! # \$ % & ' ( ) \* + , . / ; < > = ? " [ ] ^ { } | ~. Do not use a symbol other than an underscore (\_) as the first character.
- Use the same username and password for both Windows and the TeraStation or you may not be able to access shared folders.
- Do not duplicate user IDs, group IDs, usernames, or group names. Each should be distinct and unique.
- For Windows 8, use a local username instead of your Windows Live ID.

## Importing User Information

You can import users in *File Sharing - Users* by clicking *Import CSV File*. Note that existing users will be overwritten. Format for user data: Username (required), password (required), and user description (optional).

Examples:

- username1,password1,comment1
- username2,password2,comment2

- username3,password3,comment3

Guidelines:

- Use commas (,) as separators. Do not put spaces before or after commas.
- If a line has an incorrect format, the user on that line will not be registered.
- If a username exists, the new user information will overwrite the old information.
- Do not use commas (,) in the username, password, or user description.

**Note:** Importing users may take some time. During import, other operations in Settings may be much slower than usual.

## Quotas

To add a quota for a user, click *Quota* at the bottom of the “Add User” screen. Enter a number in GB.

## Shared Folder Owners

To confirm the owner of a shared folder from Windows XP, from the *Properties* screen of the file or folder, open a new window from the *Security* tab. Click *Advanced*, then click the *Owner* tab.

## Adding Groups

---

- 1 In *File Sharing*, select *Groups*.



- 2 Click *Add Group*.

### 3 Enter settings, then click *OK*.

The screenshot shows the 'Group Settings' dialog box. It contains the following fields and options:

- Group Name:** A text input field with a red asterisk indicating it is required.
- Group ID:** A text input field with a note: "(\* Enter a number from 1000 to 1999)".
- Group Privileges:** A dropdown menu currently set to 'General Users'.
- Select a recipient for group notifications:** Two radio buttons: 'User' (selected) and 'Email address'. Below 'User' is a dropdown menu set to 'Disabled'.
- Description:** A large text area.
- Quota:** Two radio buttons: 'Enable(Units: GB)' and 'Disabled' (selected). Below 'Enable' is a 'Quota Capacity' spinner set to '0'.
- Username List:** A list box titled 'Username' containing one entry: 'admin' with an unchecked checkbox. Below the list are 'Select All' and 'Unselect All' buttons.
- Buttons:** 'OK' and 'Cancel' buttons at the bottom.
- Legend:** A red asterisk followed by the text '\* Required'.

#### Notes:

- If the group ID field is left blank, a group ID is automatically assigned. Use numbers between 1000 and 1999 to set a group ID manually. Don't use duplicate group IDs.
- Quotas may not work properly if a user ID or group ID is duplicated. Always use distinct, unique usernames and group names.
- Group names may contain up to 20 alphanumeric characters, hyphens (-), underscores (\_), and periods (.). Do not use a symbol other than an underscore (\_) as the first character.
- Group descriptions may contain up to 75 alphanumeric characters, hyphens (-), underscores (\_), and spaces. Do not use a symbol or space as the first character.
- You may register up to 300 groups with the TeraStation.

## Access Restrictions

---

### 1 In File Sharing, select *Folder Setup*.

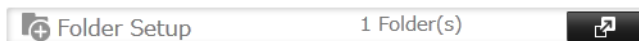

### 2 Click the shared folder that you want to set access restrictions for.

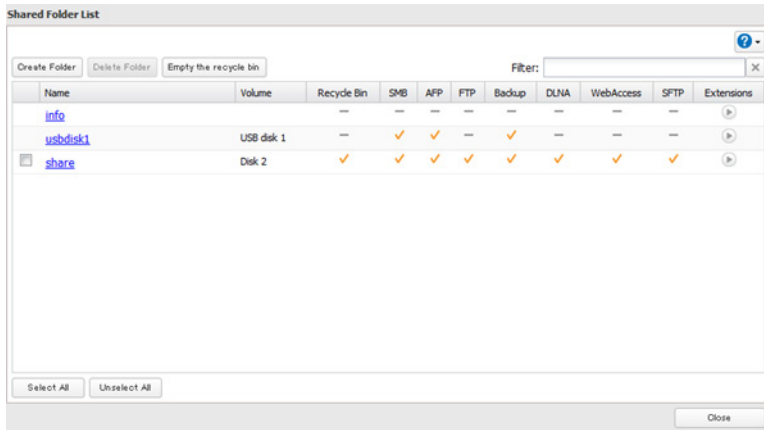

**3** Click *Edit*.

**4** Enable “Access Restrictions”.

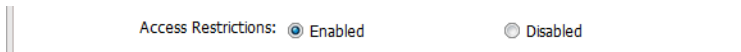

**5** Select the level of access for the user or group you added.

- WR**: Read and write access allowed
- R**: Read access allowed
- Access prohibited

**Note:** An example of access restrictions by local users is shown in the screen. To apply access restrictions by group, click the *Local Groups* tab and select group permissions.

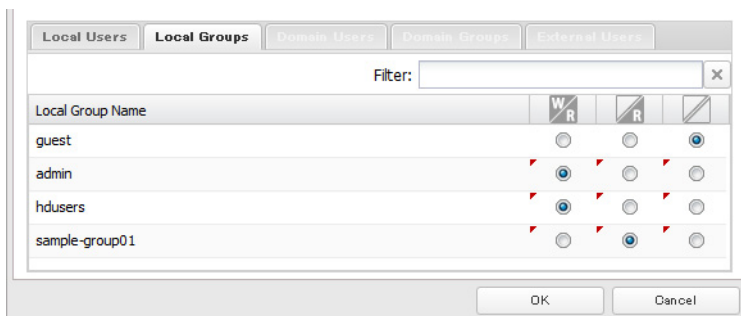

**6** Click *OK*.

**Notes:**

- If you log in from a Microsoft network domain, you can set access restrictions with users and groups from the domain.
- If both “Read only” and “Read & Write” permissions are given to a user, the user will have read-only access.

# Active Directory

The TeraStation can join an Active Directory domain. Up to 1000 domain users and 1000 groups may be downloaded from Active Directory.

**Note:** If usernames or group names from Active Directory include multi-byte characters, you will not be able to configure access restrictions for them.

- 1 In Settings, select *Network*.



- 2 Select *Workgroup/Domain*.



- 3 Click *Edit*.

- 4 Select "Active Directory", then click *Next*.

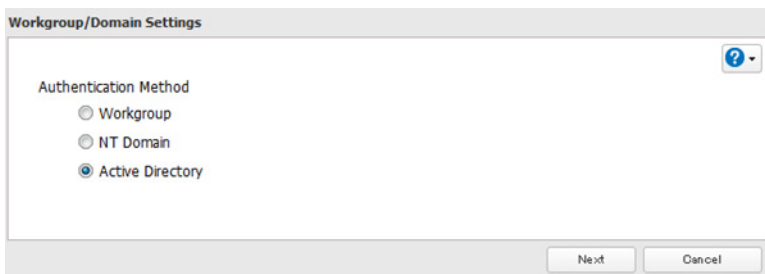

- 5 Click *Yes*.

- 6 Enter the desired settings, then click *OK*.

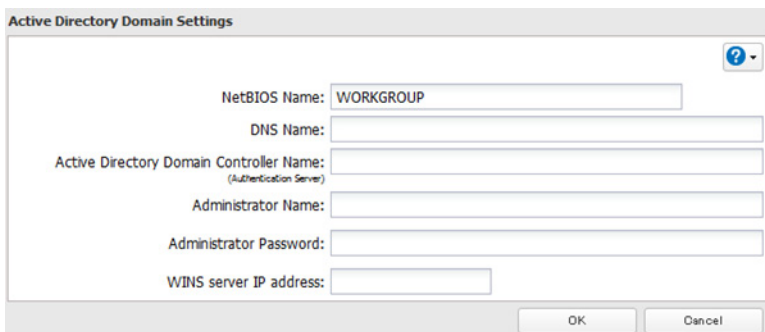

- 7 Choose *Folder Setup*.



- 8 Click a shared folder that you want to set access restrictions for.

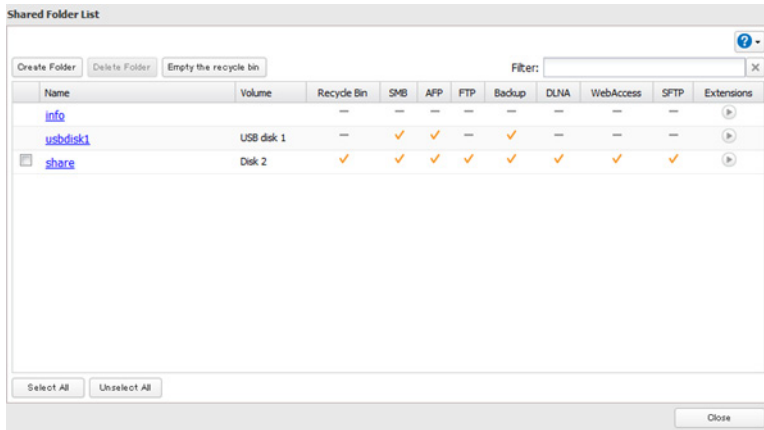

**9** Click *Edit*.

**10** Enable “Access Restrictions”.

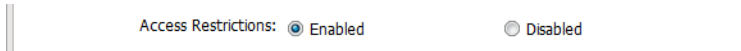

**11** Select the level of access for the user or group:

- W**  
**R**: Read and write access allowed
- R**: Read access allowed
- : Access prohibited

**12** Click *OK*.

**Notes:**

- To have the TeraStation join an Active Directory domain, configure it to use a DNS server that can resolve names for the Active Directory domain.
- After building an Active Directory domain, the administrator password for joining the domain must be changed at least once, or joining the Active Directory domain will fail.
- The DNS name and NetBIOS name of Active Directory domains should be identical.
- If both read-only and read & write permissions are given, the user will have read-only access. The most restrictive access setting will apply.
- If there are more than 5 minutes difference between the TeraStation’s clock and the domain controller’s clock, joining the domain or authenticating domain users and groups may fail. For best results, use an NTP server to set the time for all network devices.

## NT Domains

In an NT domain environment, the TeraStation uses account information from the NT domain server to set access restrictions for files and folders on the TeraStation. There’s no need to perform individual account management for the TeraStation. If multiple TeraStations are installed on the network, the account information is centrally managed in the NT domain, greatly reducing the operations required for installation and management.

**Note:** A maximum of 1000 domain users and 1000 groups can be downloaded from an NT domain server.

**1** Create an account on the domain controller for the TeraStation.

2 In Settings, click *Network*.



3 Select *Workgroup/Domain*.



4 Click *Edit*.

5 Select "NT Domain", then click *Next*.

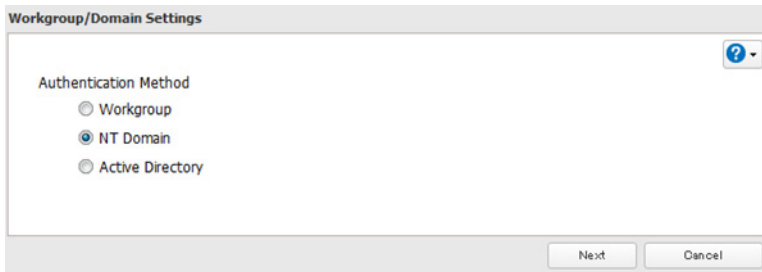

**Note:** To use Active Directory from Windows 2000 or Windows Server 2003, select *Active Directory* instead of *NT Domain*.

6 Click *Yes*.

7 Enter settings and click *OK*.

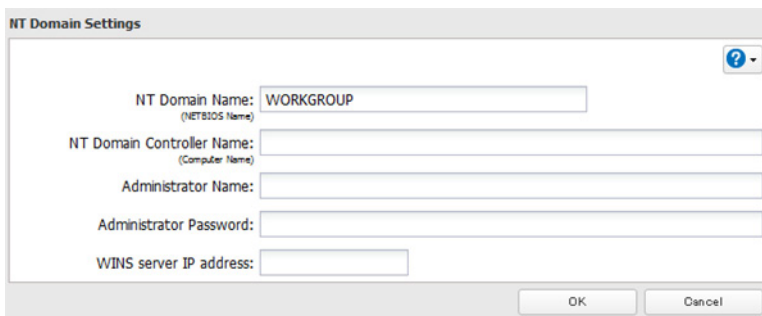

**Notes:**

- If you change the TeraStation's name, you will no longer be able to use domain users and groups or access restrictions. To repair this rejoin the domain.
- If the TeraStation has joined a domain network, you cannot connect to the TeraStation via FTP.

8 Click  to the right of "Folder Setup".



9 Click a shared folder for which you want to set access restrictions.



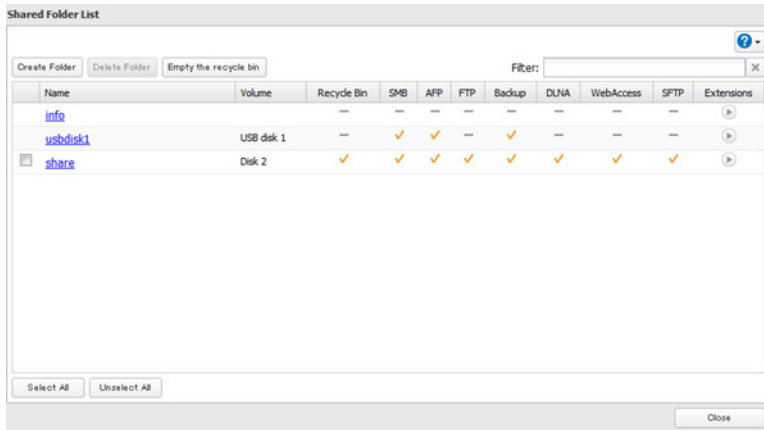

**10** Click *Edit*.

**11** Enable “Access Restrictions”.

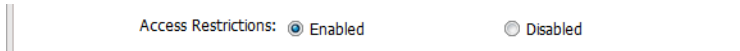

**12** Select the level of access for “Domain Users” or “Domain Groups” you added.

- WR**: Read and write access allowed
- R**: Read access allowed
- Access prohibited

**13** Click *OK*.

**Notes:**

- If both read-only and read & write permissions are given to a user, the user will have read-only access.
- If a domain username is more than 20 bytes long, the TeraStation truncates it to 20 bytes.
- The TeraStation supports a domain environment with a maximum of 1000 users and 1000 groups. 10,000 users and 10,000 groups can be downloaded from the domain controller but are not supported.
- To use the TeraStation as a member server in an NT or Active Directory domain, the TeraStation should be logged in to the domain and accessed from a computer that is not a member of the domain with a valid domain account.
- If the TeraStation is a member server of an NT or Active Directory domain, you cannot connect as a guest user via AFP.
- When you change the user or group settings on the domain controller, these changes may not take effect immediately on the TeraStation until it is rebooted.
- If your TeraStation is a member server in an NT or Active Directory domain and you change the authentication method to “Workgroup”, the account on the domain controller will not be deleted automatically.
- If the TeraStation has joined a domain network, you cannot connect to it via FTP.

## Delegating Authority to an External SMB Server

The TeraStation can link to an authentication server for centralized management of user accounts and passwords.

**Note:** When saving changes to the external authentication server settings, click *Yes* to convert all local users to external authentication users. When external authentication is removed, local user passwords will need to be set

again.

- 1 In Settings, click *Network*.



- 2 Choose *Workgroup/Domain*.



- 3 Click *Edit*.

- 4 Select "Workgroup" (even if you are in a domain environment).

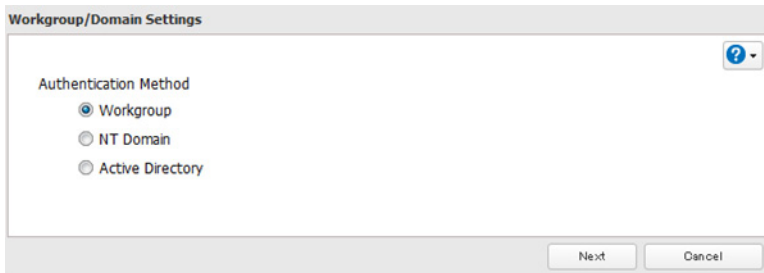

- 5 Click *Yes*.

- 6 Enter a workgroup name. Select "Assign authorization to external SMB server" and enter the authentication server's IP address (recommended) or name. If using a Windows Domain Controller for external SMB authentication, enter its name for "Workgroup Name" and check "Use a Windows domain controller as an authentication server", "Automatic User Registration" and "Use shared folder for authorization testing". Check "Use shared folder for authorization testing" and "Authentication Test Shared Folder Name". Click *OK*.

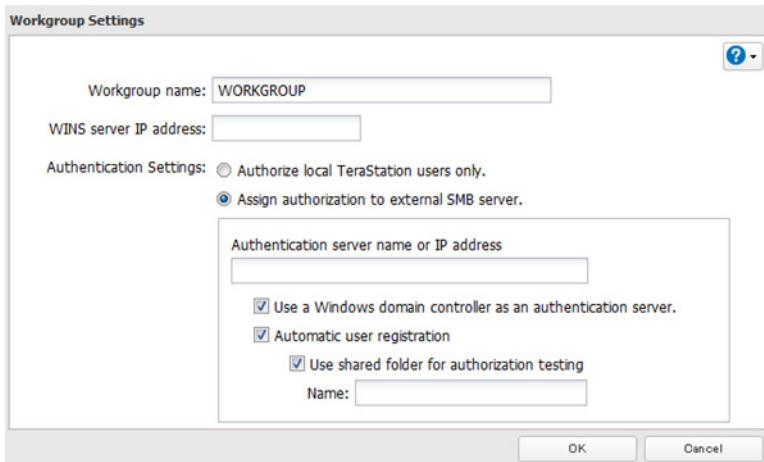

- 7 Create a shared folder for authentication on the TeraStation. Users registered to the specified authentication server are automatically registered as users on the TeraStation when they open the shared folder for authentication. You can also register users directly.

- 8 Choose *Folder Setup*.



## 9 Choose a shared folder to set access restrictions on.

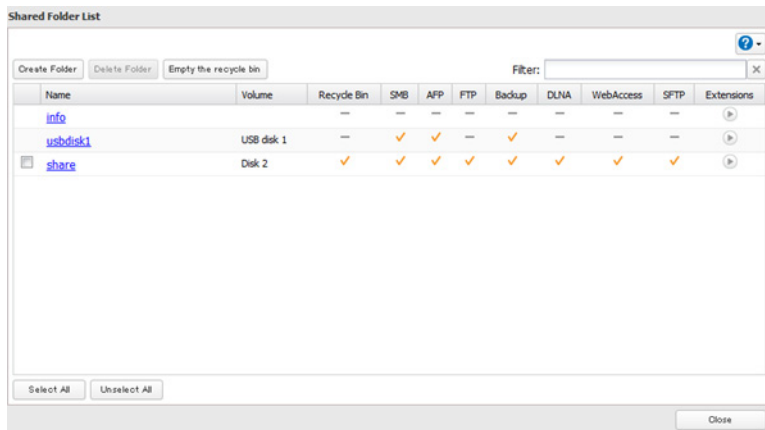

## 10 Click *Edit*.

## 11 Enable "Access Restrictions".

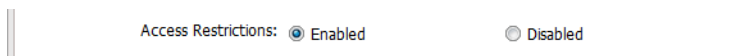

## 12 Select the level of access:

- W**/**R**: Read and write access allowed
- R**: Read access allowed
- : Access prohibited

## 13 Click *OK*.

### Notes:

- If access restrictions are set for users and groups registered in the authentication server, guest connection is not possible with AFP or FTP connections.
- Users who are automatically registered belong to the "power users" group. They can be added to other groups from within group settings.
- Access can be restricted to specific shared folders based on username.
- The names of registered users are listed in "Users" - "External Users". To delete a user who was registered automatically, select that user and click "Delete External User".
- When connecting through AFP or FTP, always use an IP address. Using a server name may cause problems with authentication.
- To specify a server from another subnet, enter its IP address.
- AFP and FTP connections do not support delegating authority to an external SMB server.
- Use AFP to access access-limited shared folders from OS X 10.7 instead of SMB. Enable "AFP (Mac)" under "LAN Protocol Support" on the destination folders to use AFP.

# Chapter 4 Managing your Storage

## RAID Arrays

TeraStations support many types of RAID. The type of RAID arrays available for use depends on how many drives are installed in your TeraStation.

TeraStation	Default RAID Mode
TS5800D TS5600D	RAID 6
TS5400D TS5400R	RAID 5
TS5200D	RAID 1

### Notes:

- If you change the RAID mode, all data on the array is deleted. This is true for every procedure in this chapter. Always back up any important data before performing actions that affect your RAID.
- After the RAID mode is changed (except when creating a RAID 0 array or JBOD), the TeraStation performs a RAID check that will take about 10 hours per TB. File transfers are slower during this period. While the message “RAID I17 ARRAYx Resyncing” is displayed on the LCD panel, do not turn off the TeraStation. If you do, the RAID check starts over.
- If the TeraStation is restarted or shut down while changing the RAID mode, the message displayed on the LCD panel changes from I46 or I47 to I18.

### RAID 6\*

RAID 6 arrays are available for TeraStations with 4 or more hard drives. RAID 6 combines 4 or more drives into a single array. The usable space is equal to the sum of the capacity of all drives minus the capacity of two drives. For example, if 4 drives are combined into a RAID 6 array, the usable space is the sum of the capacity of 2 drives. If 2 drives in the array are damaged, you can recover data by replacing them. If 3 or more drives are damaged, your data is lost.

### RAID 61\*\*\*

RAID 61 arrays are available for TeraStations with 8 or more drives. In this mode, two RAID 6 arrays are mirrored in a RAID 1 array. 8 drives in a RAID 61 array have a usable capacity of 2 x the capacity of the smallest drive.

### RAID 60\*\*\*

RAID 60 arrays are available for TeraStations with 8 or more drives. In this mode, two RAID 6 arrays are combined in a RAID 0 array. 8 drives in a RAID 60 array will have a usable capacity of 4 x the capacity of the smallest drive.

## **RAID 5\***

RAID 5 arrays are available for TeraStations with 3 or more hard drives. RAID 5 combines 3 or more drives into a single array. The usable space is equal to the sum of the capacity of the hard drives minus the capacity of one drive. For example, if 4 drives are combined into a RAID 5 array, the usable space is the sum of 3 drives. If one drive in the array is damaged, you can recover data by replacing the damaged drive. If two or more drives are damaged at the same time, your data is lost.

## **RAID 51\*\***

RAID 51 arrays are available for TeraStations with 6 or more hard drives. In this mode, two RAID 5 arrays are combined into a RAID 1 array. The total usable space for 6 drives in a RAID 51 array is 2 x the capacity of the smallest drive. For 8 drives, the total usable capacity is 3 x the capacity of the smallest drive.

## **RAID 50\*\***

RAID 50 arrays are available for TeraStations with 6 or more hard drives. In this mode, two RAID 5 arrays are combined into a RAID 0 array. The total usable space for 6 drives in a RAID 50 array is equal to 4 x the capacity of the smallest drive. For 8 drives, the total usable space is equal to 6 x the capacity of the smallest drive.

## **RAID 10\***

RAID 10 arrays are available for TeraStations with 4 or more hard drives. In this mode, mirrored pairs of drives in RAID 1 arrays are combined into a RAID 0 array. The usable space is equal to the capacity of the smallest drive multiplied by the number of hard drives ÷ 2.

## **RAID 1**

Combines 2 drives into a mirrored array. The available space in the array is the capacity of a single drive. Identical data is written to each drive. If a drive is damaged, data can be recovered by replacing the damaged drive. As long as one drive in the array remains undamaged, all data in the array can be recovered.

## **RAID 0**

Combines 2 or more hard drives into a single array. The usable disk space is the total space of all drives used. This simple RAID mode offers faster performance than RAID modes that include parity. If a single drive in the array fails, then all data in the array is lost.

## **JBOD**

This mode uses the hard drives inside the TeraStation as individual drives. The disk space you can use is the total capacity of all drives in the TeraStation. If any drive is damaged, then the data on that drive is lost.

\*Available for TS5800D, TS5600D, TS5400D, and TS5400R series.

\*\*Available for TS5800D and TS5600D series.

\*\*\*Available for TS5800D series only.

# Working with RAID Arrays

RAID settings are available in Settings in the drives section.

## Using JBOD

With JBOD, each hard drive in the TeraStation is addressed separately. To put drives from an array into JBOD mode, follow the steps below.

- 1 Select *RAID*.



- 2 Select the array to delete.

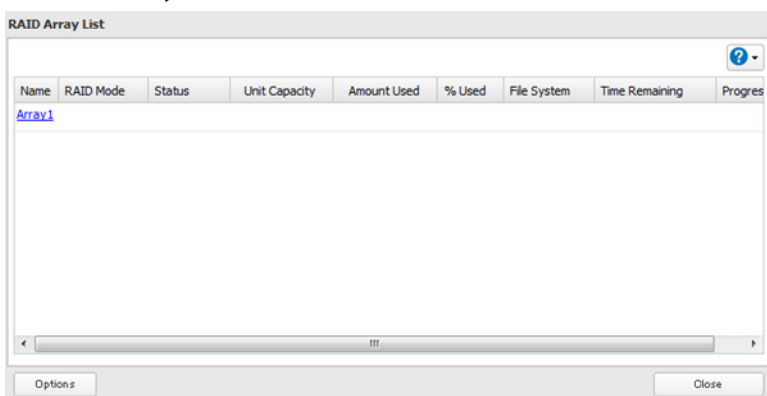

- 3 Click *Delete RAID Array*.

Once JBOD mode is configured, create shared folders on each drive to use them.

## Changing RAID Mode

To change the RAID mode, first put the drives in JBOD mode.

- 1 Select RAID.



- 2 Click the array to delete.

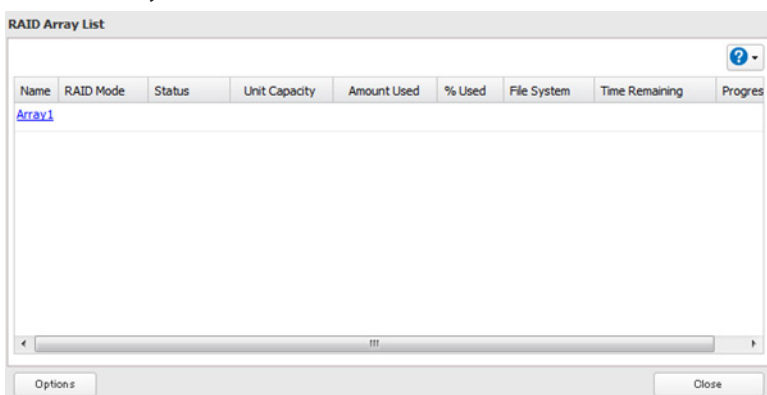

**Note:** If the “RAID Mode” field is blank, the array is already in JBOD mode. Proceed to step 7.

- 3** Click *Delete RAID Array*.
- 4** The “Confirm Operation” screen will open. Enter the displayed number, then click *OK*.
- 5** Click *OK*.
- 6** Choose the array to configure.
- 7** Select a RAID mode and the drives to be used, then click *Create RAID Array*.

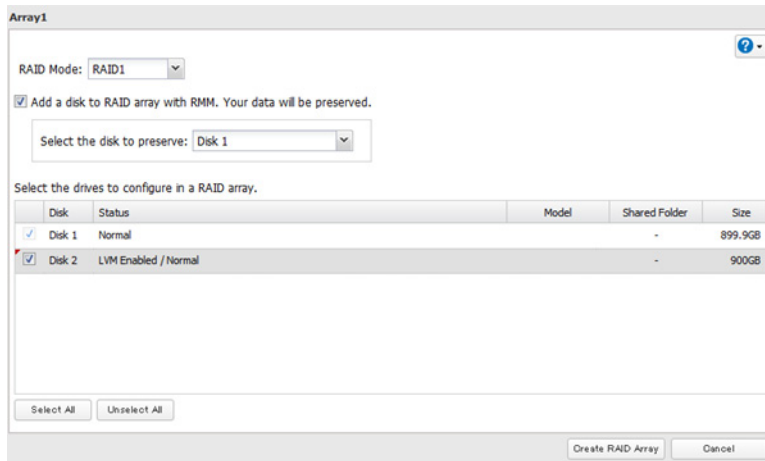

- 8** Step through the wizard to create the array.

**Notes:**

- You can also configure RAID settings from Easy Admin.
- After changing the RAID mode, create a shared folder.

## Configuring a Hot Spare

If you have a hot spare configured and an array fails, the TeraStation immediately switches over to the hot spare. To use a hot spare, you need an extra drive that’s not part of any array and a RAID 1, RAID 10, RAID 5, RAID 51, or RAID 6 array.

**Notes:**

- All data on the hot spare drive is deleted when it is configured as a hot spare and again when it changes from a spare to a drive in the array.
- A hot spare cannot be configured for TeraStation models with only two hard drives. Use RAID 1 instead.

- 1** In Settings, click *Drives*.



- 2** Choose *RAID*.

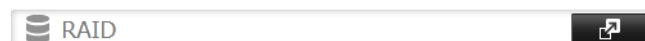

### 3 Choose a RAID array.

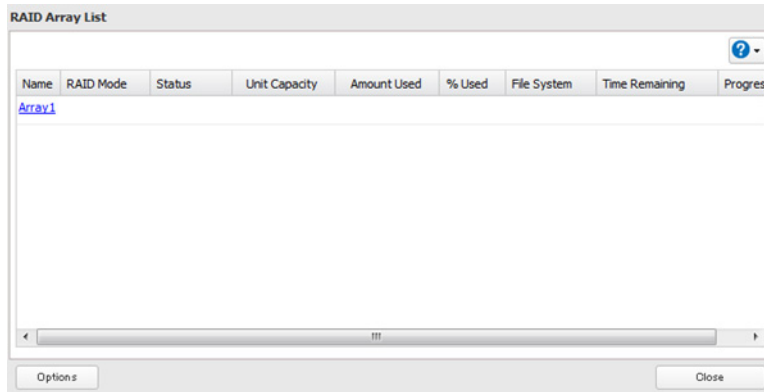

### 4 Click *Set as a hot spare*.

### 5 Step through the wizard.

### 6 When the "Confirm Operation" screen opens, enter the confirmation number and click *OK*.

#### Notes:

To turn the hot spare back into a normal disk, choose *Set as a normal disk*.

If a drive fails in the RAID array before it is rebooted, the hot spare will not automatically replace the failed drive. In this case, follow the steps below to repair the array.

- (1) In Settings, navigate to *Drives - Drives*.
- (2) Select the drive that was configured as a hot spare, then click *Dismount Disk*.
- (3) Click *Rediscover Disk*.
- (4) Navigate to *Drives - RAID*.
- (5) Select the RAID array to repair.
- (6) Select the drive that was previously configured as a hot spare, then click "Recover RAID Array".

This will rebuild the RAID array.

## RMM (RAID Mode Manager)

---

With RMM, you can create or expand a RAID array without erasing the data on the drives.

### Changing from JBOD to RAID 1

Hard drives that aren't in a RAID array show "Normal (RMM available)". You must have at least two drives available in JBOD (not in a RAID array) to build the RAID 1 array with RMM.



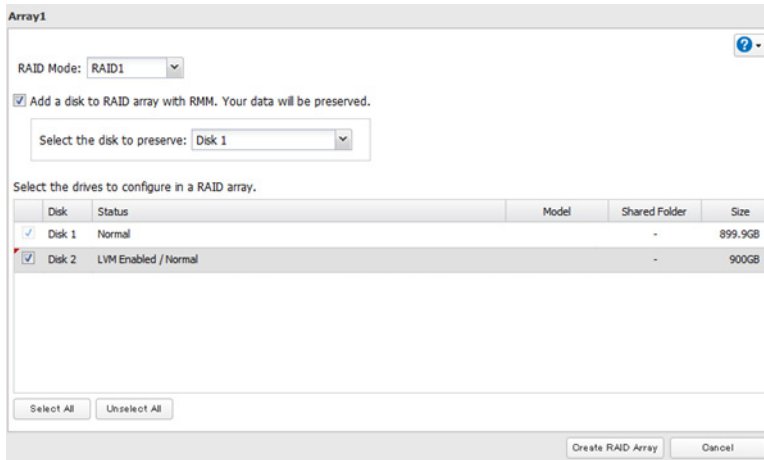

- 1** Select the drive on which you do not want to erase data.
- 2** Check "Add a disk to RAID array with RMM. Your data will be preserved."
- 3** Select the drive to add to the RAID array.
- 4** Click *Create RAID Array*. The "Confirm Operation" screen will open.
- 5** Enter the confirmation number, then click *OK*.

## Adding a drive to an existing RAID array

You can add a drive to a RAID 1, RAID 5, or RAID 6 array. Drives that can be added to the RAID array show "Normal (RMM available)" or "JBOD."

### Notes:

- Each drive must have the same capacity.
- RMM can be used to expand an array by one drive per operation. To expand by two or more drives, RMM must be performed multiple times.

- 1** Click *Drives*.



- 2** Click *RAID*.

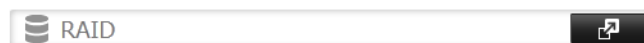

- 3** Choose a RAID array.

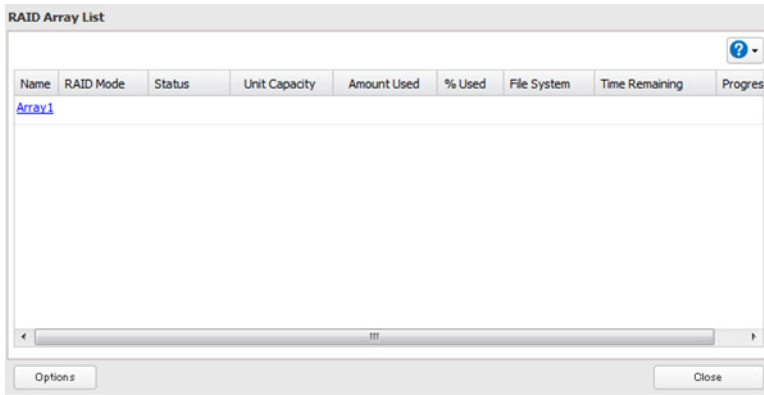

## Changing the RAID mode while adding a drive:

Select the drive you want to add to the RAID array and choose the mode for the array. Enter the “Confirm Operation” number and click OK.

## RAID Scanning

RAID maintenance scans your RAID array for bad sectors and if it finds any it automatically repairs them. RAID 1, RAID 10, RAID 5 and RAID 6 arrays are supported for most TeraStation modes. For best results, run RAID maintenance regularly.

- 1 In Settings, click *Drives*.



- 2 Click the  icon to the right of “RAID Scanning”.



- 3 Click *Edit*.

- 4 Select the schedule for running RAID maintenance, then click OK.

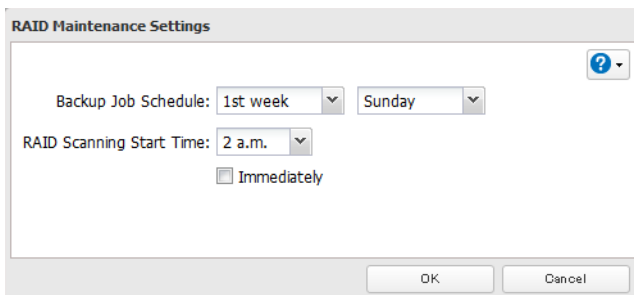

### Notes:

- Check “Immediately” to run RAID maintenance immediately.
- To stop a RAID scan, click *Abort RAID Scan*.

- 5 Move the RAID Scanning slider to the  position to enable RAID Scanning.

# Adding an External Hard Drive

## Connecting an External Drive

Your TeraStation includes USB ports (the number of ports depends on your model), and you can connect external drives to these ports. Once connected they appear as shared folders on the TeraStation. Formatted drives are detected automatically. Unformatted drives should be formatted in Settings.

After a USB drive is recognized, Windows adds “usbdisk X” under the TeraStation in “Network”, where “X” is the USB port where the hard drive is connected.

**Notes:**

- Hubs are not supported. Connect a single USB drive to each USB port.
- Backup data from Mac OS may include characters that cannot be written to FAT16 or FAT32 drives such as “.DS\_Store”. For best results, reformat the drive before using it as a backup target.

## Dismounting and Removing a USB Device

If the TeraStation is powered on, dismount any USB drives before unplugging them. If the TeraStation is off, then all USB devices are already dismounted and you can remove them safely.

If a USB drive is unplugged without being dismounted first, it may not be recognized properly when it is reconnected. If this happens, restart the TeraStation and then reconnect the drive.

## Formatting External Drives

Formatted drives are detected automatically. If a drive is not formatted, format it from Settings. Refer to “Formatting Hard Drives” for the procedure.

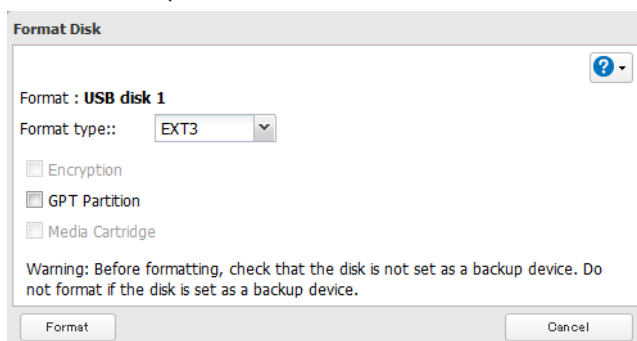

**Notes:**

- Do not turn off or disconnect power to the TeraStation while formatting a hard drive.
- A format may take anywhere from a few minutes to several hours depending on the size of your drives.

## Access Restrictions on External Drives

You can set access restrictions on new drives. Refer to “Configuring Access Restrictions” for details.

**Note:** Even if a shared folder is not visible, you can still format the drive, run a disk check, and back up to the new

drive.

## Dismounting Drives

If the TeraStation is powered on, dismount drives (internal and external) before unplugging them. You may dismount external drives with the function button, or any drive from Settings. If the TeraStation is off, then all drives are already dismounted and may be unplugged safely.

### Dismounting with the Function Button

If the TeraStation is on, hold down the function button for 7 seconds. The blue LED will go out when all attached USB drives are dismounted. You may now unplug them safely, even after if blue LED comes back on.

### Dismounting from Settings

- 1 In Settings, click *Drives*.



- 2 Navigate to *Drives - Drives*.



- 3 Select the drive to dismount and click *Dismount Disk*.

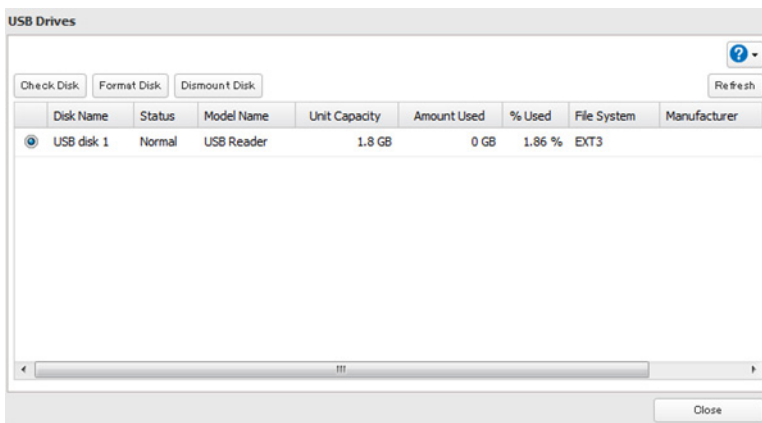

- 4 Unplug the USB device, then click *OK* when the following message is displayed.

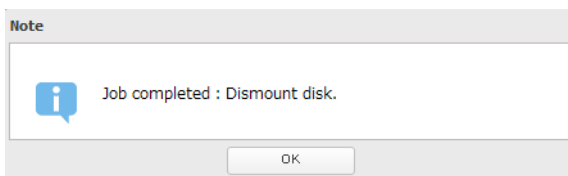

**Note:** To reconnect USB devices, wait for a few minutes.

The following devices are supported by the TeraStation:

- USB storage devices
- Card readers (except for card readers that can recognize two or more memory cards)
- Digital cameras
- USB-connected UPSs
- USB printers

Buffalo external USB drives are recommended.

These devices are not supported

- DUB and DIU series drives
- Hubs, mice, and keyboards

Connect only one device to each USB port of the TeraStation. Some external drives with automatic power-on don't turn on automatically when connected to the TeraStation. Use their manual power switch to turn them on. Be sure to connect only one bus-powered drive at a time. If there is insufficient bus power for your USB drive, connect its AC adapter. Note that only the first partition of a connected USB hard drive is mounted. Additional partitions are not recognized. Do not connect bus-powered devices to the TS5200D.

## Checking Drives

A disk check tests the data on a drive in the TeraStation or connected via USB for integrity. Errors are fixed automatically. With large drives, a disk check may run for many hours. Shared folders cannot be accessed during a disk check. Do not turn off the TeraStation until the disk check is finished. Use the procedure below to run a disk check.

**1** In Settings, click *Drives*.

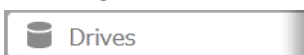

**2** Select *Drives* to check an internal drive or *USB Drives* to check an external drive.



**3** Select the drive to test, then click *Check Disk*.

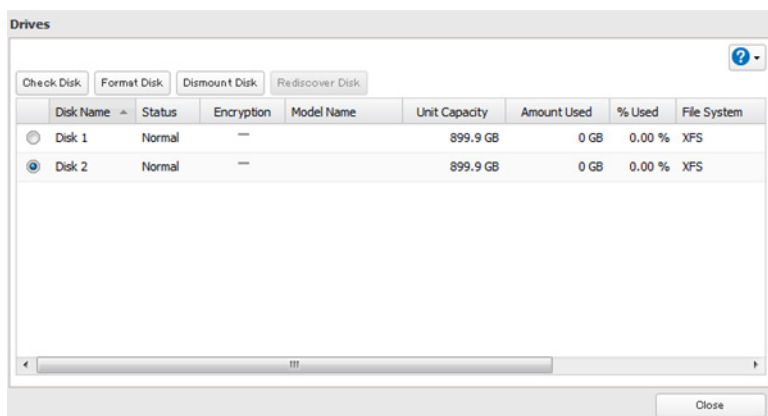

**4** Click *Check*. You have the option of deleting information files from Mac OS during the check if desired.

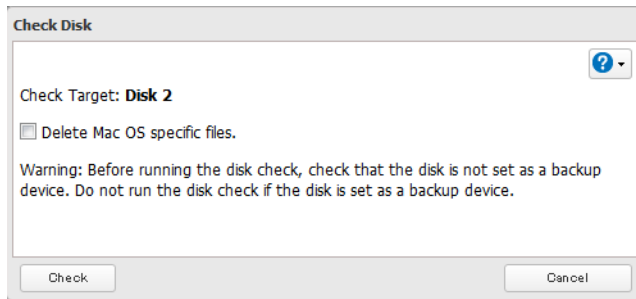

Note:

## Formatting Drives

**Note:** Under some circumstances, data deleted when a drive is formatted can be recovered. To ensure that data is “gone forever”, a format might not be sufficient. See “Erase Data on the TeraStation Completely”.

- 1 In Settings, click *Drives*.

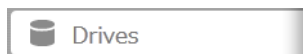

- 2 Select *Drives* to format an internal drive or *USB Drives* to format an external drive.

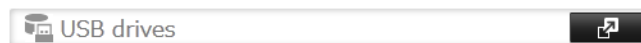
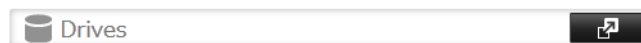

- 3 Select the drive to format, then click *Format Disk*.

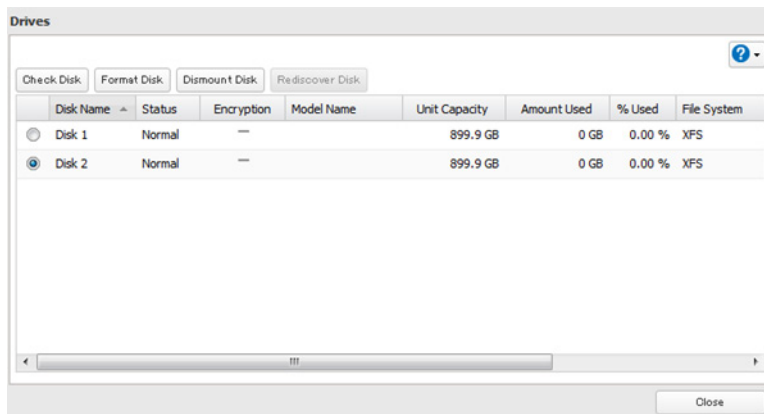

- 4 Select a format type, then click *Format*.

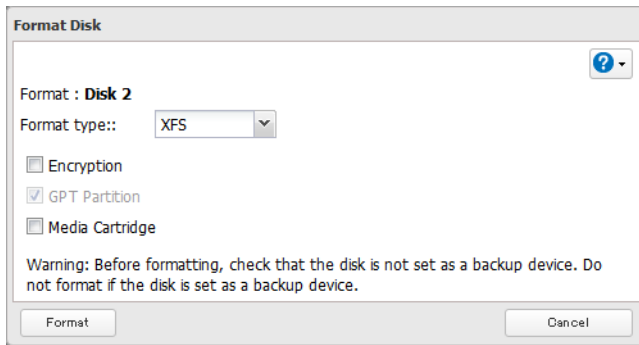

- 5 The “Confirm Operation” screen will open. Enter the displayed number, then click *OK*.

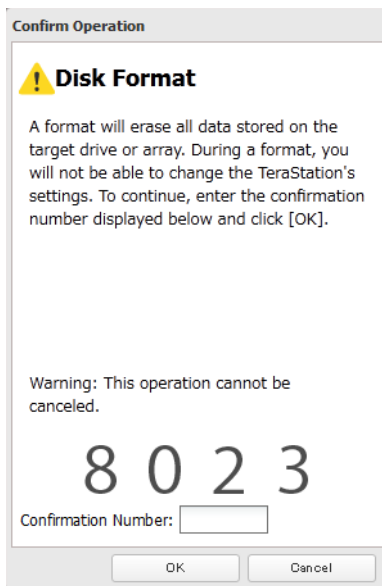

- 6 Depending on the size of your drive, the format may take several minutes or several hours to complete. “Formatting” will be displayed on the LCD display until the format is complete.

## Encrypting Drives

Internal drives (and arrays) can be encrypted with 128-bit AES during formatting. Encrypted drives and arrays are then readable only from that specific TeraStation. To unencrypt a drive or array, uncheck “Encryption” and format it again.

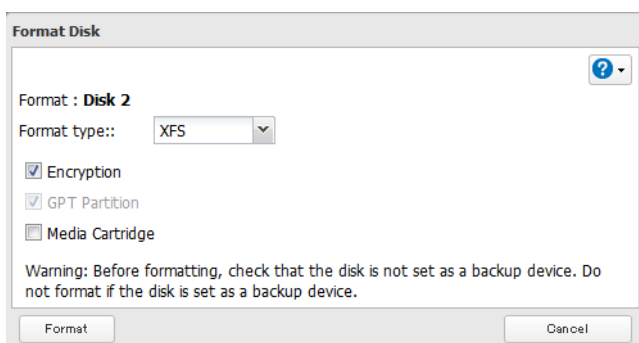

## Media Cartridges

If configured as a media cartridge, an internal drive can be used as a removable storage device in the same way as an external drive. Media cartridges can be unplugged and connected to a different TeraStation with all data intact.

To configure a drive as a media cartridge, check “Media Cartridge” during formatting. To return it to its original state, uncheck “Media Cartridge” and reformat the drive.

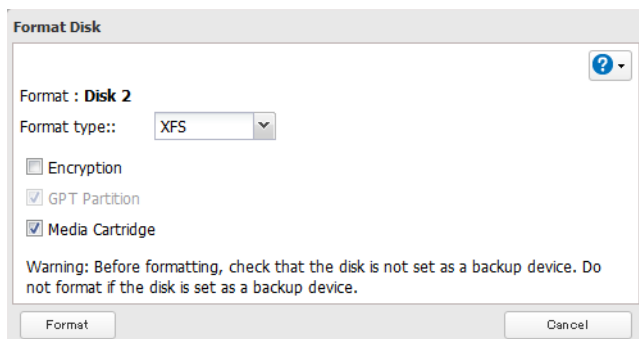

Media cartridges do not support:

- RAID arrays
- LVM volumes
- Access restrictions
- Direct connection to a Windows computer

## Erase Data on the TeraStation Completely

Under some circumstances, data from formatted drives can be recovered. The disk erasure process in this section does a much more thorough job of erasing data. This procedure is recommended for removing all data from a drive in a way that makes it nearly impossible to recover with current tools. All data on the drives is completely erased. The TeraStation will then be in the following state:

- All drives in JBOD mode
- An empty shared folder on each drive
- All settings returned to their default values
- All logs deleted

If you remove a drive and then erase all data on the TeraStation, the LCD will show the error “HDx Error E22 HDx Can’t Mount” where X is the hard drive you removed. You can still use the TeraStation.

**1** In Settings, click *Management*.



**2** Select *Restore/Erase*.



**3** Click *Erase TeraStations*.



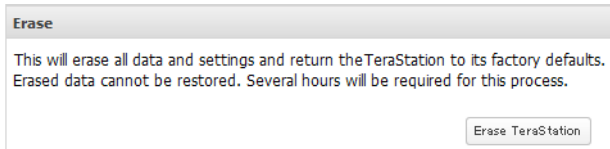

- 4** The “Confirm Operation” screen will open. Enter the displayed number, then click *OK*.

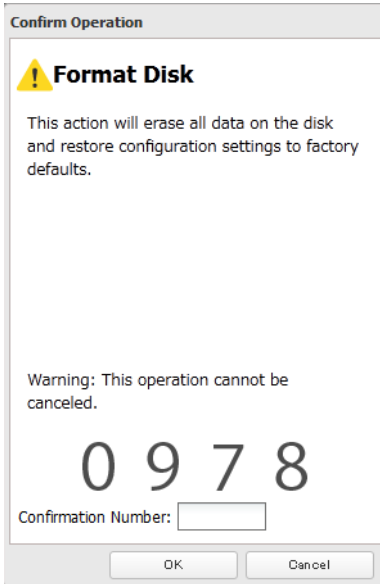

- 5** All data on the TeraStation will be permanently erased.

## Disk Quotas

### Notes:

- When using quotas, disable the recycle bin or empty the trash folder often. The limited space includes the space used for trash.
- Quotas apply per drive or per array. If a quota is set to 1 GB, each array or drive can use a maximum of 1 GB.
- Quotas cannot be set for external hard drives connected to the TeraStation and hard drives that are configured as media cartridges.

## Quotas for Users

---

Follow this procedure to limit the shared folder disk space available for a user.

- 1** In Settings, click  to the right of “Users”.



- 2** Select the user whose space will be limited.
- 3** Enable quotas, choose the maximum space the user will be allowed to use, and click *OK*.

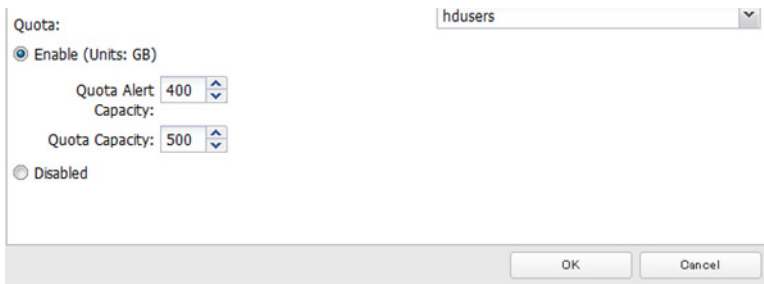

**Note:** If you change the primary group, restart the LinkStation to apply the quota settings.

- 4 Click *Close*.

## Quotas for Groups

---

Follow the procedure below to limit the space for shared folders that each group can use.

- 1 In Settings, click  to the right of "Groups".



- 2 Select the group whose space will be limited.

- 3 Enable quotas, choose the maximum space the group is allowed, and click *OK*.



- 4 Click *Close*.

- 5 In Settings, click  to the right of "Users".



- 6 Change the user's primary group to the group with the quota, then click *OK*.

- 7 Click *Close*.

## Size Limits

---

If LVM is enabled, volumes can be created with maximum size limits.

- 1 In Settings, click *Drives*.



2 Select LVM.

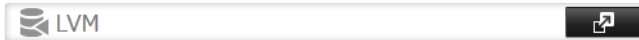

3 Select the drive where the volume will be located and click *Enable LVM on Volume*.

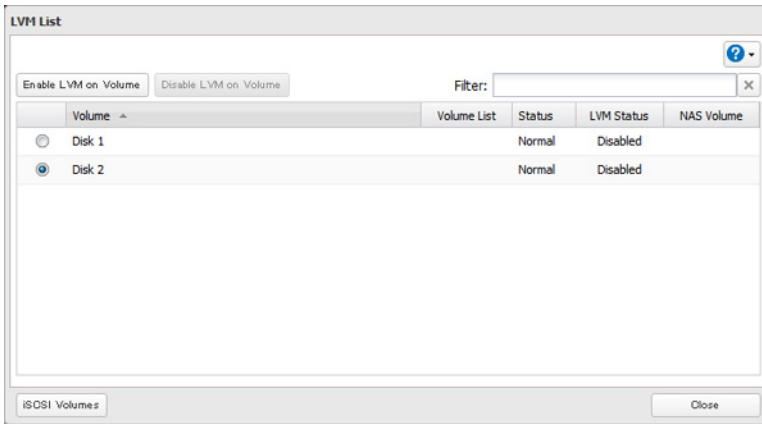

4 The "Confirm Operation" screen will open. Enter the displayed number, then click *OK*.

5 Click *OK*.

6 Click *Edit* under "NAS Volume".

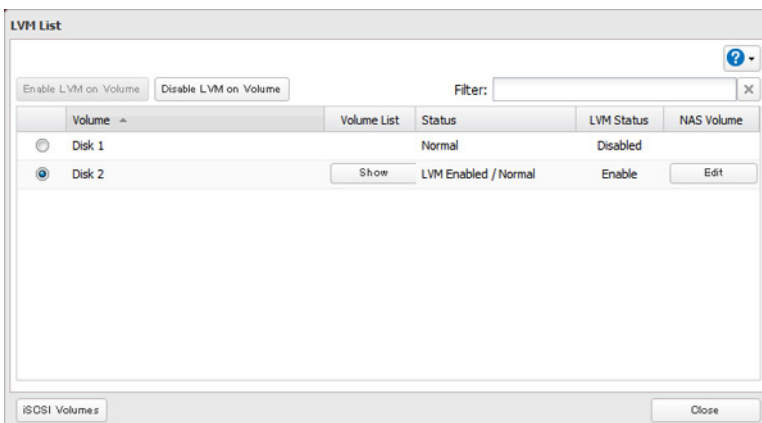

7 Click *Create Volume*.

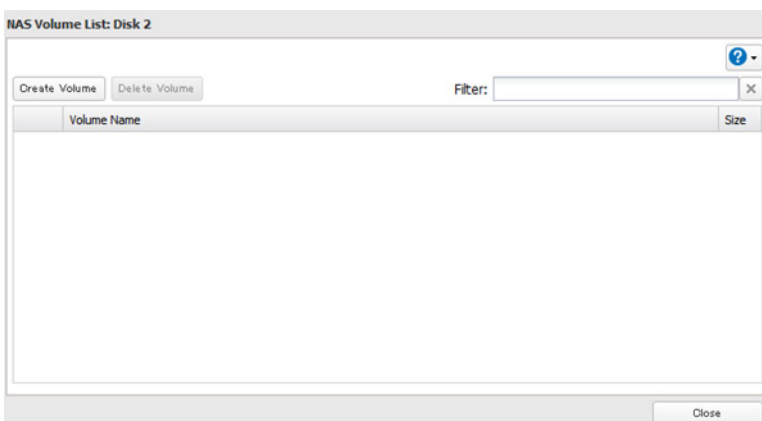

**8** Configure the desired settings, then click *OK*.

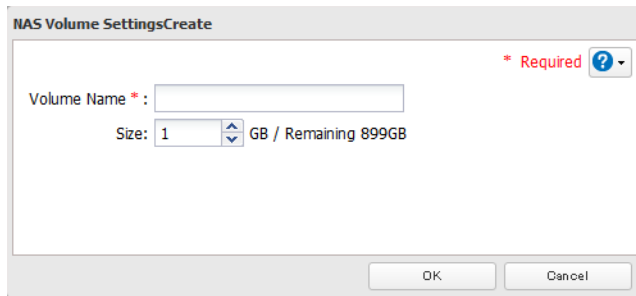

The screenshot shows a dialog box titled "NAS Volume SettingsCreate". It contains a text input field for "Volume Name" with a red asterisk and a "Required" label. Below it is a spin box for "Size" set to "1" with the text "GB / Remaining 899GB". There are "OK" and "Cancel" buttons at the bottom.

**9** Click *Close*.

**10** Click *Close*.

**11** Navigate to *File Sharing - Folder Setup*.



**12** Click *Create Folder*.

**13** Configure the settings.

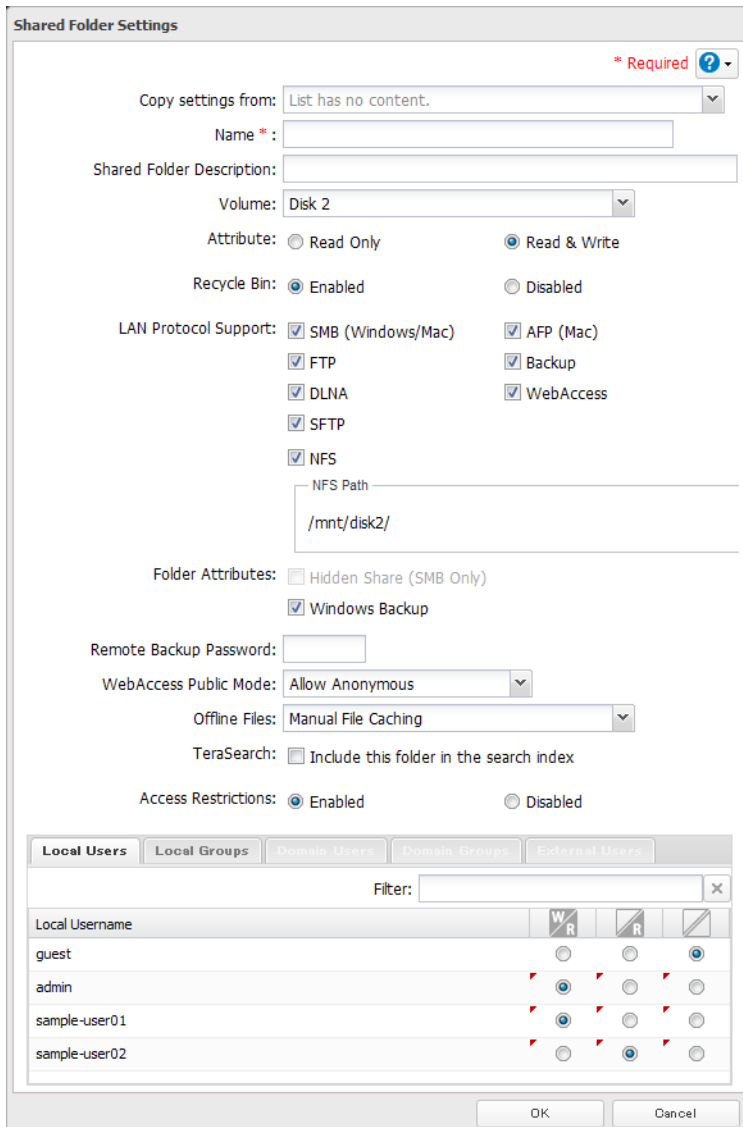

### Notes:

- The name may contain up to 27 alphanumeric characters, hyphens (-), and underscores (\_). Do not use a symbol as the first character.
- The description may contain up to 75 alphanumeric characters, hyphens (-), underscores (\_), and spaces. Do not use a symbol or space as the first character.
- If multi-byte characters are used in a shared folder name used for both AFP and FTP, configure the client language to match the characters that are being used. Also, you may be unable to access the folder if certain characters are used in the name, so the use of letters and numbers only is recommended.
- The names of shared folders used for both AFP and FTP should not use characters from different language sets (such as mixing Japanese and Korean characters, for instance).

**14** Select the volume that you created and click *OK*.

# Using the TeraStation as an iSCSI Device

## Introduction

---

iSCSI is a protocol for carrying SCSI commands over IP networks. Unlike traditional SAN protocols such as fibre channel, which requires special-purpose cabling, iSCSI can be run over long distances using existing network infrastructure. Normal Windows formatting such as NTFS is supported.

## Differences Between NAS and iSCSI

With iSCSI, a server creates shared folders in the iSCSI-connected TeraStation and the computer accesses the shared folders of the server. The TeraStation can be used as a local drive from Windows Server. Features of Windows Server such as Active Directory can be used normally.

As a NAS, the TeraStation is a server, and computers (including other servers) on the network can access shared folders on it directly. A separate server is not required, and features such as backup are built-in.

## Network Configuration

Use gigabit or faster network equipment with iSCSI. For best results, a dedicated network for iSCSI is recommended, separate from the regular network. Use fixed IP addresses for storage devices such as the TeraStation.

## Install the Microsoft iSCSI Software Initiator

### Windows XP, Windows 2000, Windows Server 2003, Windows 2000 Server

Before using iSCSI equipment with Windows XP, Windows 2000, Windows Server 2003, or Windows 2000 Server, download and install the "Microsoft iSCSI Software Initiator".

- 1** Go to [www.microsoft.com](http://www.microsoft.com).
- 2** Search for "Microsoft iSCSI Software Initiator".
- 3** Download the latest version of the Microsoft iSCSI Software Initiator.
- 4** When the download is complete, double-click on the installer. Check the "Initiator Service" and "Software Initiator" checkboxes.

Step through the wizard to install.

### Windows 8, Windows 7, Windows Vista, Windows Server 2008

If you are using Windows 8, Windows 7, Windows Vista, or Windows Server 2008, the Microsoft iSCSI Software Initiator is already installed on your computer. You don't need to download and install it.

## iSCSI Setup

To use the TeraStation as an iSCSI hard drive, configure it as described below.

**1** Connect the TeraStation's Ethernet and power cables and configure the TeraStation's IP address and its clock.

**2** In Settings, click *Drives*.



**3** Choose *LVM*.



**4** Select the drive where the volume will be created and click *Enable LVM on Volume*.

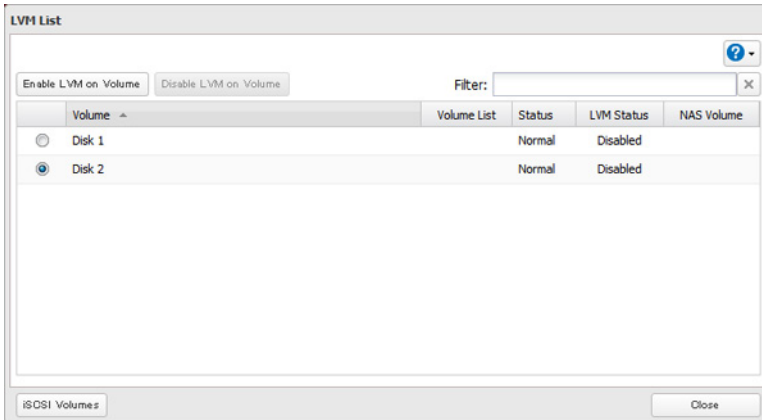

**Notes:**

- Enable LVM before using the TeraStation as an iSCSI drive.
- If the LVM settings are changed, all data on the volume will be erased. Before changing the settings, back up any important data.

**5** The "Confirm Operation" screen will open. Enter the displayed number, then click *OK*.

**6** Click *OK*.

**7** Move the iSCSI slider to the  position to enable iSCSI.



**8** Click  to the right of "iSCSI".

**9** Click *Create Volume*.

**10** Enter a volume name, volume description, volume, and size, then click *OK*.

**11** Click *Close*.

**12** Connect the new volume. The process will depend on which connection software you're using.

**Procedure using Buffalo's iSCSI Connection Tool**

- Install the iSCSI Connection Tool on your computer from the CD supplied with the TeraStation, or download it from [www.buffalotech.com](http://www.buffalotech.com).

- Click *Start - All Programs - BUFFALO - iSCSI Connection Tool - iSCSI Connection Tool*. For Windows 8, click the *iSCSI Connection Tool*.
- Click *Register iSCSI Device*, select the volume to connect, and click *Connect*.

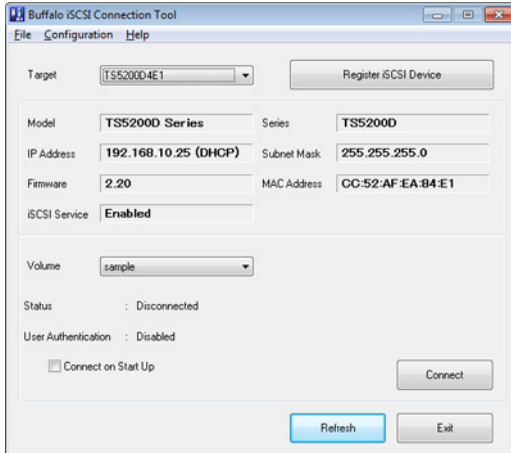

**Notes:**

If you will use the TeraStation regularly, check “Connect on Start Up” before connecting. Always disconnect the volume before shutting down the TeraStation.

For the iSCSI Initiator included with Windows 8, Windows 7, Windows Vista, and Windows Server 2008:

Navigate to *Control Panel - Administrative Tools - iSCSI Initiator* and enter the IP address of the TeraStation in the “Target” field. Click *Quick Connect*.

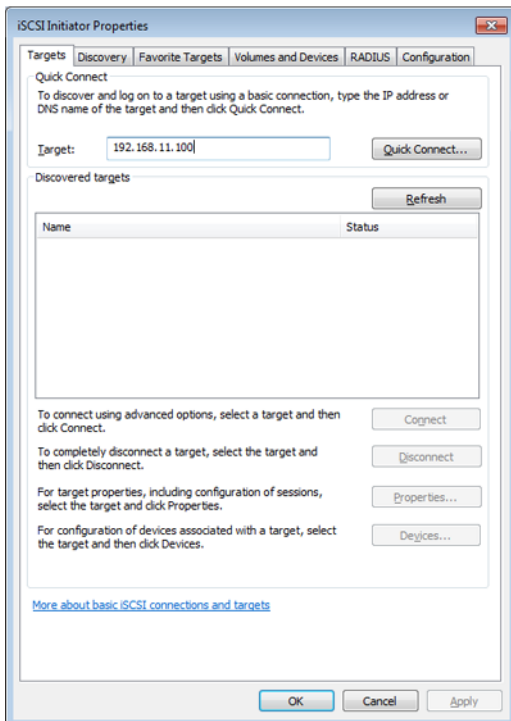

**13** The connected volume will be recognized by the computer as an unallocated volume. Assign and format the volume in Windows. When the format process is completed, the drive will be visible as an icon in “Computer” or “My Computer” and can be used as a normal drive on the computer.



## Use with Multiple Computers

If the TeraStation is divided into multiple volumes (or drives), it can be used with multiple computers.

- 1 Create multiple LVM volumes, then create multiple iSCSI volumes. You can create up to 32 volumes.
- 2 Download and install the iSCSI Connection Tool from [www.buffalotech.com](http://www.buffalotech.com).
- 3 Launch the tool at *Start - All Programs - BUFFALO - iSCSI Connection Tool - iSCSI Connection Tool*. For Windows 8, click the *iSCSI Connection Tool*.
- 4 Click *Register iSCSI Device*, select the volume to connect, and click *Connect*.

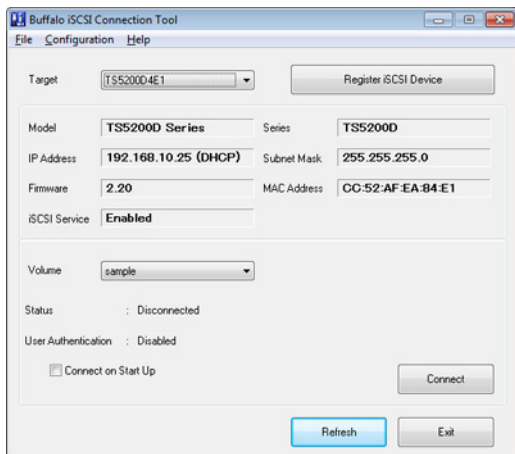

### Notes:

- Volumes that are currently in use cannot be connected.
- If the TeraStation will be used regularly, check “Connect on Startup” before connecting.

- 5 The connected volume will be recognized by the computer as an unallocated volume. Assign and format the volume in Windows.

## Checking Whether iSCSI Volume is Connected from the Client

To check whether an iSCSI volume is connected from the client (computer), navigate to *Drives - iSCSI - iSCSI Settings* and select *Connection*. If “Connected” is displayed, the TeraStation is currently connected from the client.

## Using the iSCSI Connection Tool

---

### Registering the TeraStation and Connecting the Volumes

If the TeraStation is divided into multiple volumes or drives, it can be used with multiple computers.

- 1 Connect the Ethernet cable of the TeraStation to the network.
- 2 Click *Start - All Programs - BUFFALO - iSCSI Connection Tool - iSCSI Connection Tool*. For Windows 8, click the *iSCSI Connection Tool*.

- 3 Select the TeraStation from the *Target product* list, then click *Register iSCSI Device*.

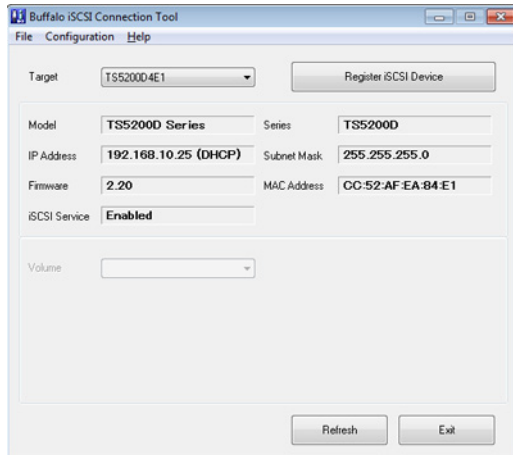

**Note:** If access restrictions are configured, enter your username and password.

- 4 Select the volume to be connected and click *Connect*.

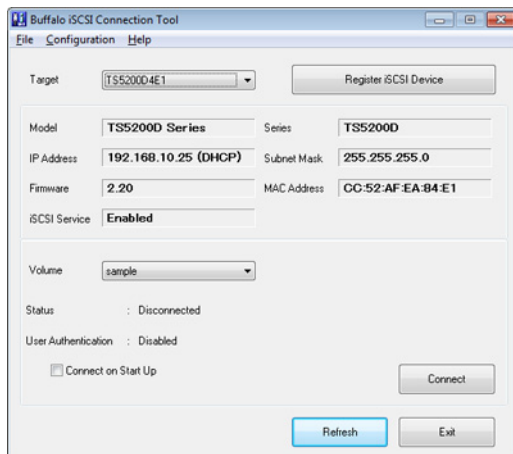

The connected volume is added as a local drive in Computer (or My Computer). Repeat these steps on each computer to connect multiple volumes.

**Note:** If using Windows XP or Windows 2000, use LVM to create volumes that are 2 TB or smaller.

## Mutual Authentication in the TeraStation

The TeraStation can perform mutual authentication. Dual passwords ensure that only authorized client computers can access the volume on the TeraStation. To configure mutual authentication, see “Registering the TeraStation and Connecting the Volumes”.

### Mutual Authentication Password Setup for the TeraStation (System)

In Settings, navigate to *Drives - iSCSI - Security - Access Restrictions for Entire System - Edit - Access Restrictions*, then click *Mutual Authentication* and set the password (mutual authentication).

### Mutual Authentication Password Setup for Individual Volumes

In Settings, navigate to *Drives - iSCSI - Create Volume or Delete Volume - Access Restrictions*, then click *Mutual Authentication*, and set the password. The password that is set here is used when connecting to the volume. The volume is connected when this password matches the mutual authentication password that was set at the computer.

## Mutual Authentication Password Setup for Your Computer

If you are using mutual authentication by the TeraStation or by each volume, enter the same password as the one that was set for the access restrictions for the TeraStation or for each volume in the mutual authentication password entry screen. If there are multiple volumes, the computer connects to the volumes whose password was entered here. The computer cannot connect to multiple volumes with different mutual authentication passwords at the same time. To change the mutual authentication password at the computer to the mutual authentication password for another volume, navigate to *Setup - Set Mutual CHAP Secret* in the iSCSI Connection Tool menu.

**Note:** If different passwords are set for the mutual authentication password of the TeraStation (entire system) and mutual authentication passwords for each volume, after the volume is connected, the volume name will no longer be displayed in the "Volume" field of the iSCSI Connection Tool. If this happens, navigate to *Setup - Set Mutual CHAP Secret* in the iSCSI Connection Tool, enter the TeraStation's password, and click *OK*.

## Disconnecting and Unregistering the TeraStation

To disconnect the TeraStation, disconnect the volume and remove the registration as shown below.

- 1 Click *Start - All Programs - BUFFALO - iSCSI Connection Tool - iSCSI Connection Tool*. For Windows 8, click the *iSCSI Connection Tool*.
- 2 Select the volume to disconnect from "Volume", then click *Disconnect*.

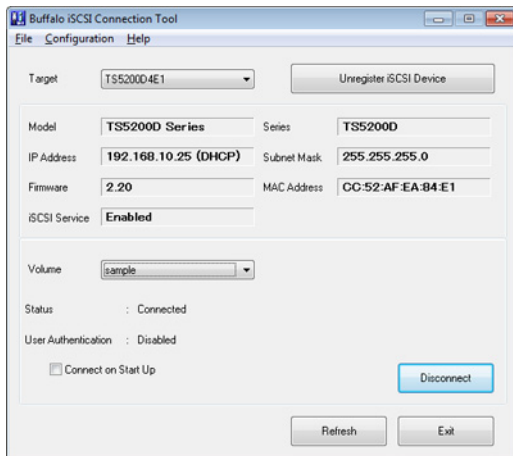

- 3 Click *Yes*.

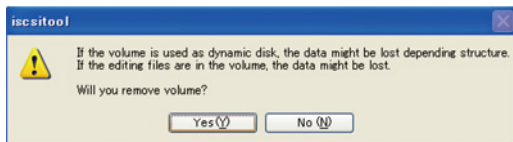

- 4 Select the TeraStation to be disconnected from "Target", then click *Unregister iSCSI Device*.

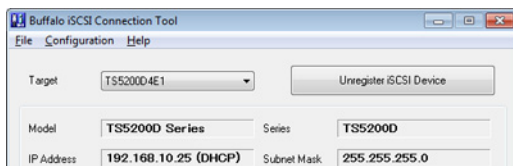

**Note:** When connecting to the TeraStation from multiple computers, follow the above procedure to remove the

registration from each computer.

- 5 Disconnect the Ethernet cable of the TeraStation.  
The TeraStation is now disconnected.

**Note:** To disconnect multiple volumes in a single operation, follow the procedure below.

- (1) Start the iSCSI Connection Tool.
- (2) Click *Setup - Remove the registered iSCSI Hard Disk*.
- (3) Select the IP address (port number) of each TeraStation that you want to disconnect and click *Remove*.

## Creating and Expanding Volumes

---

### Creating an iSCSI Volume

32 iSCSI volumes are supported. A maximum of 255 volumes can be created. Each individual iSCSI volume can be connected to different computers (a single iSCSI volume cannot be connected to multiple computers).

**Notes:**

- When an iSCSI volume is deleted, all data contained in the iSCSI volume is erased. Before changing settings, back up any important data.
- Enable LVM (previous page) to delete or create volumes.

- 1 In Settings, click *Drives*.



- 2 Click *iSCSI*.



- 3 Click *Create Volume*.

- 4 Choose a name, description, volume, and size, then click *OK*.

- 5 Click *Close*.

**Note:** Before use, connect the new volume with an iSCSI connection tool and format the volume from within your OS.

### Expanding the Volume Size

You can expand the size of a volume. If the iSCSI volume is on an LVM-enabled drive or array, you can also create or delete the volume.

- 1 In Settings, click *Drives*.



- 2 Choose *iSCSI*.



**3** Click the volume you want to expand.

**4** Enter a new size and click *OK*.

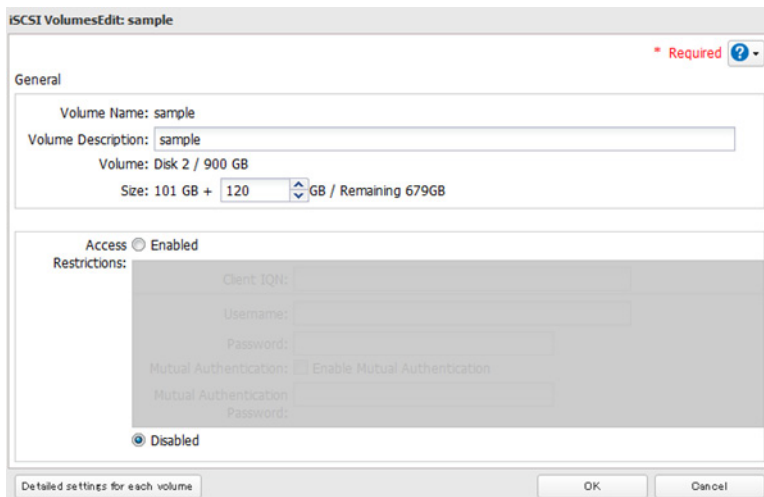

**5** Click *OK*.

**6** Click *Close*.

## Setting Access Restrictions

---

A username and password can be set following the procedure below for the entire TeraStation iSCSI volume or for each volume. When the access restrictions are set, the system asks for entry of a username and password when the TeraStation is connected by the iSCSI Connection Tool.

### Setting Access Restrictions for an Entire iSCSI Volume

**1** In Settings, click *Drives*.



**2** Click  to go into iSCSI settings.

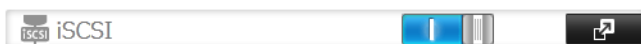

**3** Click the *Security* tab.

**4** Click *Edit*.

**5** Enable "Access Restrictions", enter the username and password, and click *OK*.

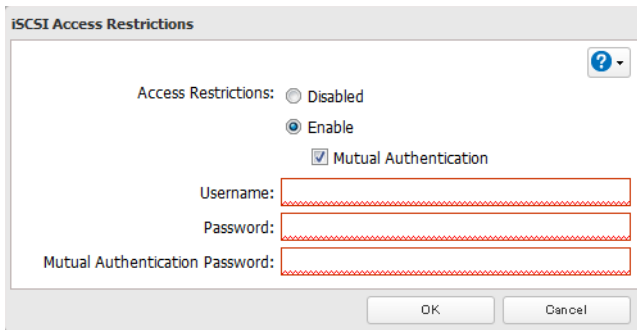

**Note:** To use mutual authentication with access restrictions, configure the settings:

- In the screen shown above, check “Mutual Authentication” and enter the password in the “Mutual Authentication Password” field.
- In the “User Authorization” window displayed when the TeraStation is connected, select “Enable Mutual Authentication” to connect. Enter the mutual authentication password.
- If using the iSCSI Initiator from Windows 8, Windows 7, Windows Vista, or Windows Server 2008, configure the CHAP login information to allow searching for or connecting to targets.

**6** Click *Close*.

## Setting Access Restrictions Volumes

**1** In Settings, click *Drives*.



**2** Click  to the right of “iSCSI”.



**3** Click the volume where you want to set the access restrictions.

**4** Enable “Access Restrictions”, enter the username and password, then click *OK*.

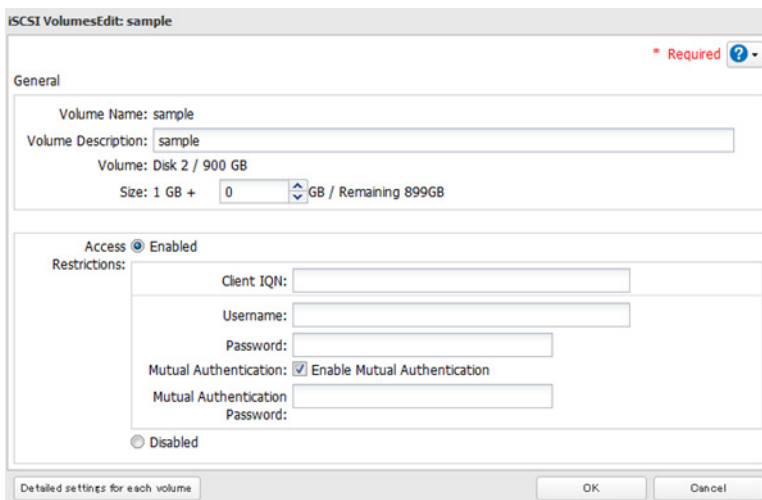

**5** Click *Close*.

## Mutual authentication access restrictions by username and password

To set access restrictions using mutual authentication in addition to regular access restrictions, configure the settings as shown below.

- In the screen above, check “Mutual Authentication” and enter the password in the “Mutual Authentication Password” field.
- In the “User Authorization” screen displayed when the TeraStation is connected, select “Enable Mutual Authentication”.
- The entry screen for the mutual authentication password is displayed again. Enter the password that was set.
- If using the iSCSI Initiator included with Windows 8, Windows 7, Windows Vista, or Windows Server 2008, set the CHAP login information performing searches and connections for targets.

## Mutual authentication access restrictions by IP address

To set access restrictions by IP address, configure the settings as shown below.

Enable “IP Address Restrictions” in the screen above, enter the IP address where access is allowed in “IP Address List”, and click OK.

## Hard Drive Replacement

Hard drives in the TeraStation show a blue status LED during normal operation. When a drive fails, its error LED will glow red.

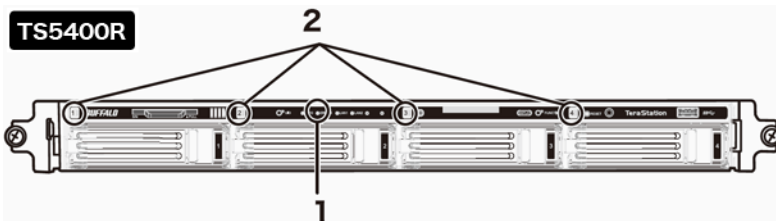

## 1. Error LED

Glow red if a drive has failed.

## 2. Status LEDs

The failed drive's status LED will be glowing a steady red. A drive with a red status LED is ready to hot-swap.

**Note:**

**Notes:**

- Do not unplug a drive whose status LED is green instead of red. Dismount it first or shut down the TeraStation before swapping a working drive. If you remove the drive without properly dismounting it, data may be lost or the TeraStation may malfunction.
- Use a Buffalo OP-HDS series drive of the same size or larger for the replacement drive. If a larger drive is used, the extra space will not be usable in a RAID array.
- To avoid damaging the TeraStation with static electricity, ground yourself by touching something made of metal before handling any sensitive electronic parts.
- After a drive is replaced, it takes about 30 minutes before normal file reading and writing are restored. Settings may not be accessible during this period.
- Do not change the order of the hard drives in the TeraStation. For example, pulling out drive 1 and replacing it with drive 2 may cause data to be corrupted or lost.
- If the LCD display does not change after a new drive is installed, click *Rediscover Disk* in Settings.

## Hard Drive Replacement Examples

---

### Drive Replacement (using a redundant RAID mode such as RAID 1, 5, or 6 with auto-shutdown disabled)

This section describes replacing a drive with [the TeraStation on](#).

- 1 TS5800D,TS5600D,TS5400D,TS5200D: Open the front cover with the included key.



**TS5400D**



**2** The failed drive's status LED will be glowing red. Push its unlock button and swing the lock mechanism out.

**TS5400D**



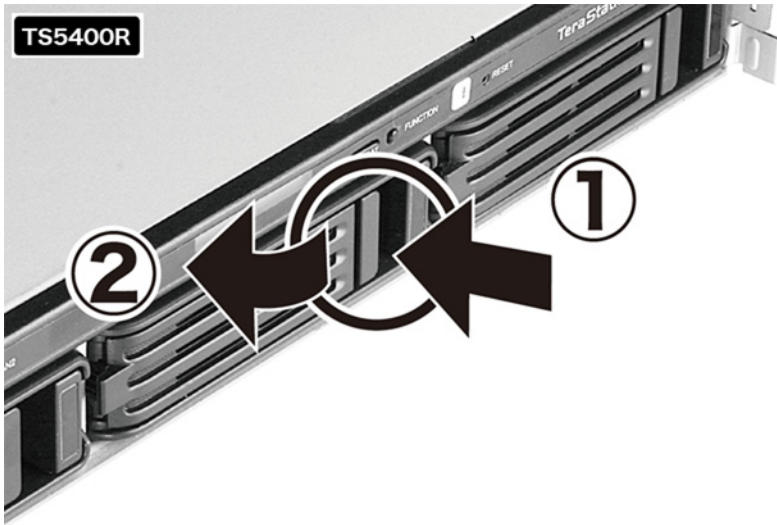

Hard drives without red status LEDs lit are still on. Do not unplug or remove them.

- 3** Pull out the drive cartridge and remove it from the TeraStation.



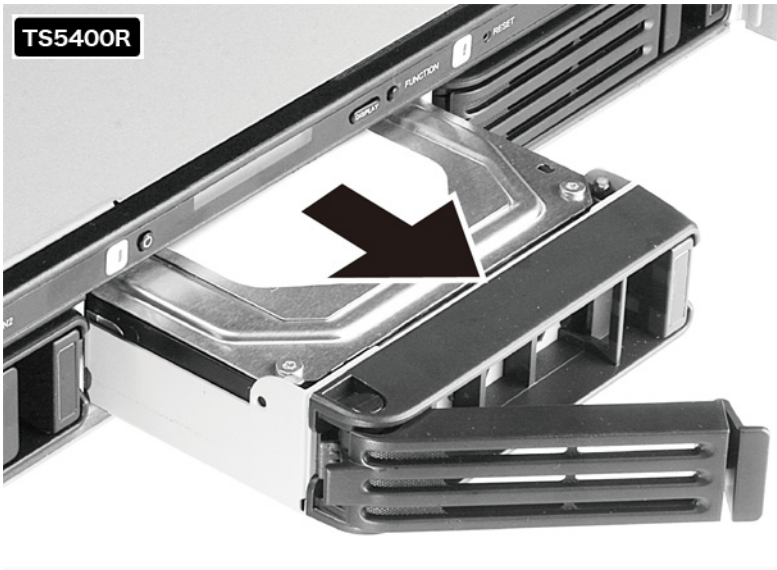

- 4** Insert the new drive in the empty slot. Slide the drive in with the locking mechanism open.



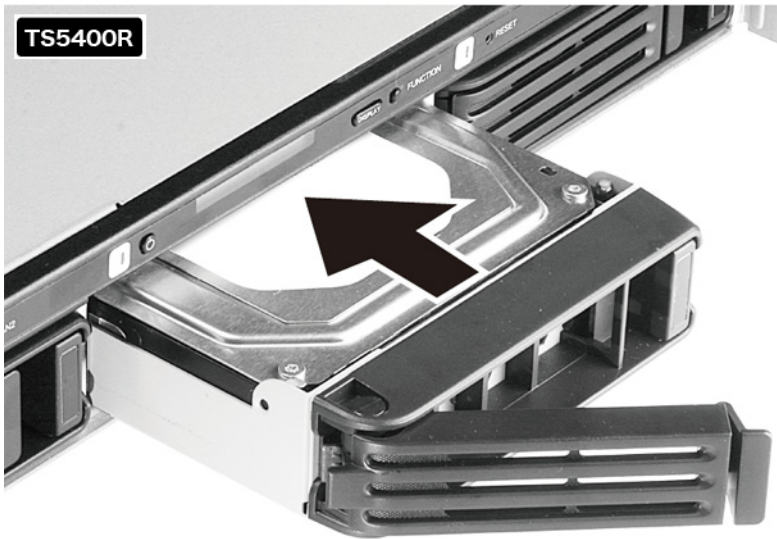

- 5** Swing the lock back down until it clicks into place.



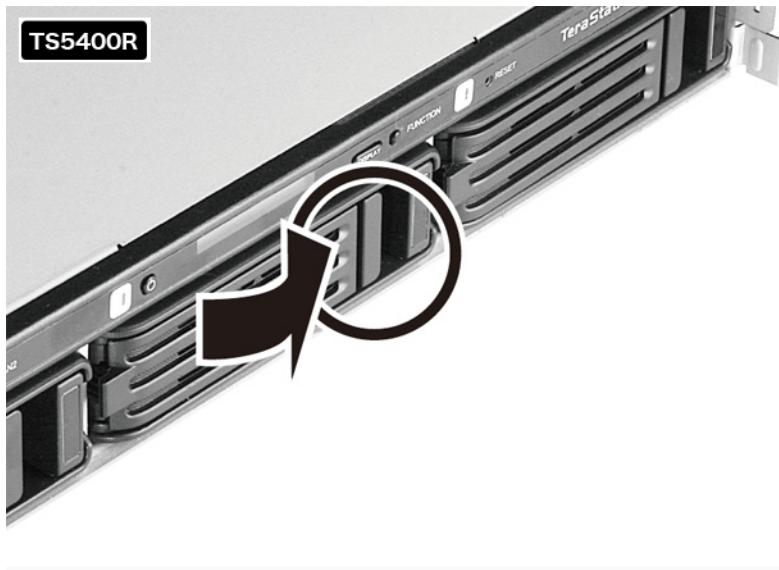

- 6** When the replacement hard drive is recognized, the status LED will flash red and the message “Press FuncSW I31 New Disk x ready” will be displayed on the LCD panel.
- 7** Hold down the function button on the front of the TeraStation for 3 seconds until it beeps. The TeraStation will start rebuilding the RAID array automatically. After a few minutes, the message “RAID I18 ARRAYx Rebuilding” will be displayed until the drive is rebuilt.

### **Drive Replacement (using a redundant RAID mode such as RAID 1, 5, or 6 with auto-shutdown enabled)**

This section describes the process of replacing a drive while **the TeraStation is off**.

- 1** Open the front cover with the key.
- 2** Push the unlock button of the failed hard drive and swing the lock mechanism out.
- 3** Pull out the drive cartridge and remove it from the TeraStation.
- 4** Insert the new hard drive in the empty slot. Slide the drive in with the locking mechanism open. Swing the lock back down until it clicks into place.
- 5** Press the power button on the TeraStation.
- 6** When the replacement hard drive is recognized, the status LED will flash red and the message “Press FuncSW I31 New Disk x ready” will be displayed on the LCD panel.
- 7** Hold down the function button on the front of the TeraStation for 3 seconds until it beeps. The TeraStation will start rebuilding the RAID array automatically. It takes about 5 minutes before the message “RAID I18 ARRAYx Rebuilding” is displayed.

## Drive Replacement (RAID 0 or JBOD)

Drives in a RAID 0 array or JBOD mode do not automatically turn off in the event of a malfunction. Before replacing the failed drive, either dismount the drive from Settings, or shut down the TeraStation.

This section describes the process of replacing a drive with [the TeraStation on](#).

- 1 Open the front cover with the included key.
- 2 In Settings, navigate to *Drives - Drives*.
- 3 Select the hard drive with the flashing status LED and click *Dismount Disk*.

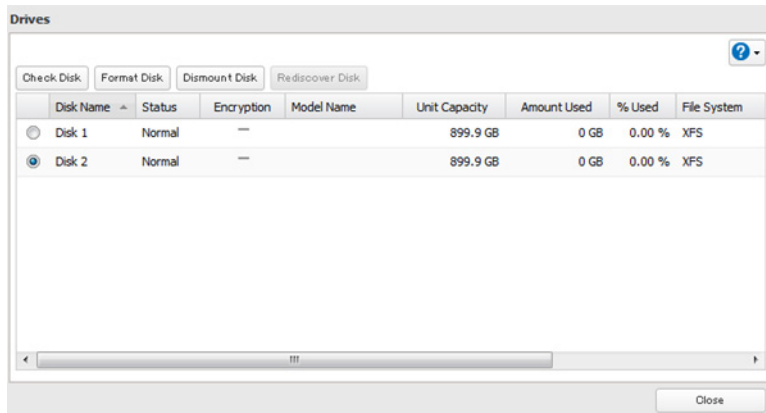

Enter the number that appears on the screen, then click *OK*.

- 4 The status LED will stop flashing and glow steadily.
- 5 Unlock the failed drive by pushing the unlock button and swinging the lock mechanism out.
- 6 Pull out the hard drive cartridge and remove it from the TeraStation.
- 7 Insert the new hard drive (sold separately) into the empty slot. Slide the drive in with the locking mechanism open. Swing the lock back down until it clicks into place.

## 8

### For RAID 0

When the replacement drive is recognized, the status LED will flash red and the message "Set From Web I32 New Diskx ready" will be displayed on the LCD panel.

Select *Drives - RAID - the RAID array In Settings* and click *Delete RAID Array*.

Select the replacement hard drive by navigating to *Drives - Drives* and clicking *Format Disk* to format the new drive. Configure RAID mode by selecting *Drives - RAID* after formatting the hard drive.

If a hard drive malfunctions in RAID 0, all data on the RAID array will be lost. All of the settings for the shared folders (such as access restrictions) are erased after replacing a drive from a RAID 0 array. Create a shared folder before use.

Enter the number that appears on the screen, then click *OK*.

### For JBOD

When the replacement hard drive is recognized, the status LED will flash red and the message "Press FuncSW I31 New Disk x ready" will be displayed on the LCD panel. Hold down the function button on the front of the TeraStation for 3 seconds until it beeps. The drive will be formatted as an individual drive. If this drive is removed from the TeraStation, shared folder settings such as access restrictions will be lost. Create a shared folder on the drive before use.

## Drive Replacement (using a redundant RAID mode such as RAID 1, 5, or 6 with a hot spare configured)

If your TeraStation's drives are in a redundant RAID mode, and you have a hot spare enabled, a malfunctioning drive in the array is replaced by the spare disk and the RAID array is rebuilt automatically. The status LED will continue to glow red for the failed drive even after the RAID array is rebuilt with the hot spare. This section describes the replacement process for a hard drive while **the TeraStation is still on**.

- 1** Open the front cover with the included key.
- 2** The failed drive's status LED will be glowing red. Push its unlock button and swing the lock mechanism out.
- 3** Pull out the drive cartridge and remove it from the TeraStation.
- 4** Insert the new drive in the empty slot. Slide the drive in with the locking mechanism open. Swing the lock back down until it clicks into place.
- 5** When the replacement drive is recognized, the status LED will flash red and the message "Press FuncSW I31 New Disk x ready" will be displayed on the LCD panel.
- 6** Hold down the function button on the front of the TeraStation for 3 seconds until it beeps. The replacement hard drive is automatically registered as a hot spare.  
To use the replacement disk as a normal drive rather than a hot spare, navigate to *Drives - RAID* and click the RAID array, select the new drive, and click *Set as a normal disk*.

## Replacing a Media Cartridge

Drives configured as media cartridges may be removed and moved to a different TeraStation for use. Before unplugging the drive, dismount it in Settings or shut down the TeraStation.

# Chapter 5 Backup

## Back Up from the TeraStation

You can back up TeraStation folders to:

- A different folder on the TeraStation
- Another LinkStation on the network
- Another TeraStation on the network

You can also configure backup jobs from Easy Admin.

## Preparing a Backup Destination

---

First, configure a folder as a backup destination.

- 1** In Settings, navigate to *Folder Setup*.



- 2** Choose the folder to set as a backup destination.
- 3** Click *Edit*.
- 4** Check "Backup" from "LAN Protocol Support", then click *OK*.



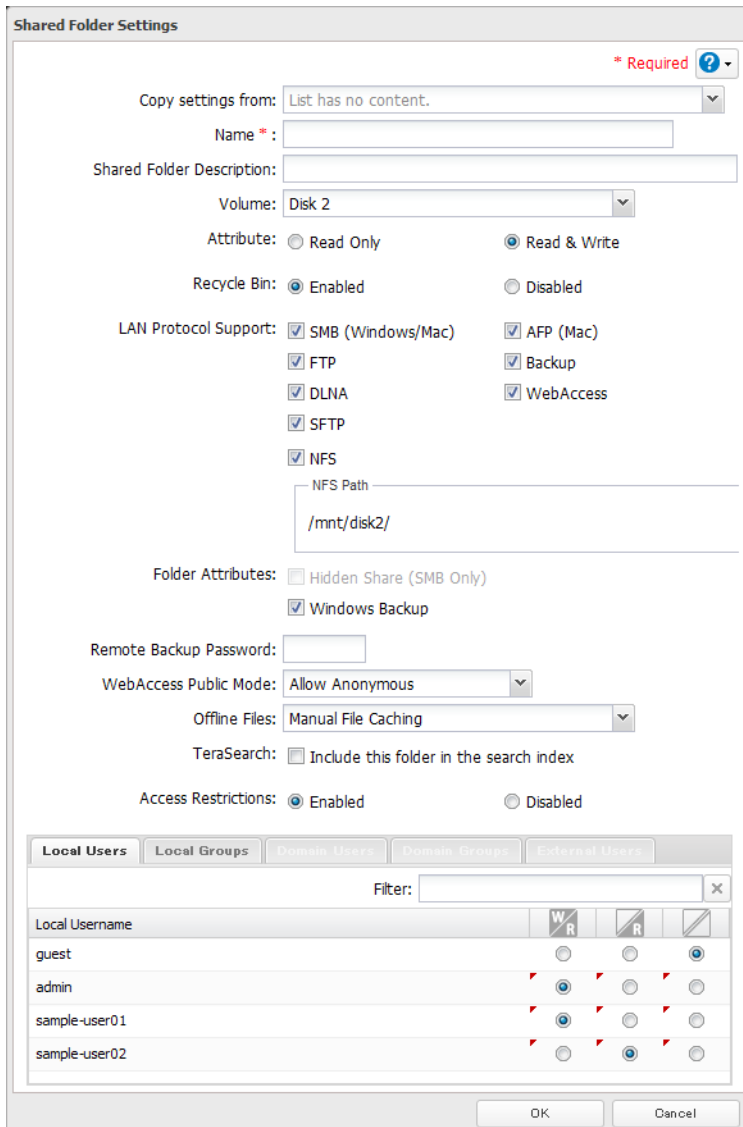

**Note:** To configure a password, enter it in the “Remote Backup Password” field. Leave this field blank if you don’t want a password. If the target device is configured with a backup password, you can search for the password from the backup source.

## Backing up to a LinkStation or TeraStation on another network when connected by a VPN

You can back up to a LinkStation or TeraStation on another network as long as the two networks are connected by a VPN. Follow this procedure to enter the IP address or hostname of the target LinkStation or TeraStation.

- 1 In Settings, click *Backup*.



- 2 Click  to the right of “Backup”.



### 3 Click *List of LinkStations and TeraStations*.

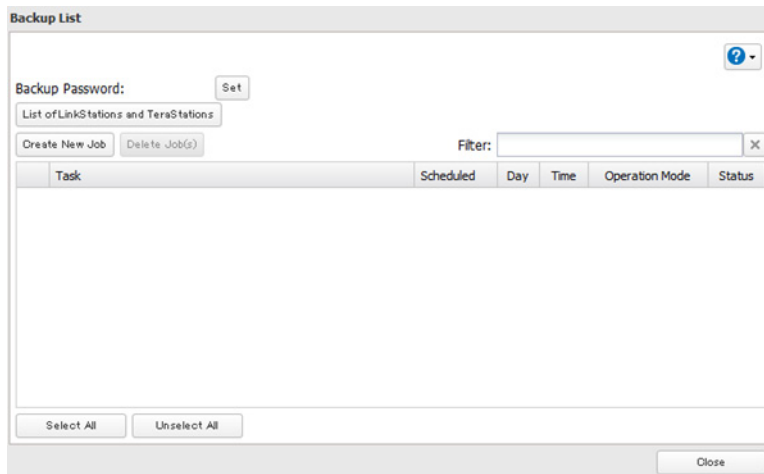

### 4 Click *Add*, enter the IP address of the target LinkStation or TeraStation, and click *Close*.

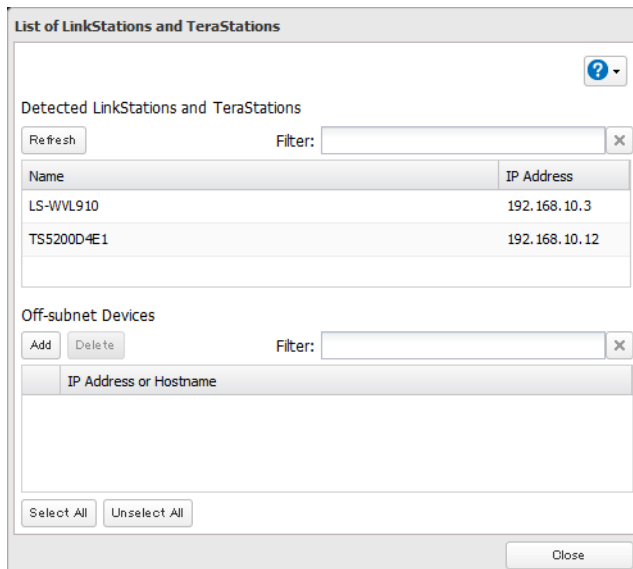

If your setup meets these requirements, you don't have to configure these settings:

- The source and target TeraStations are on the same network.
- No backup password is set for the target TeraStation.
- No TeraStation from outside the subnet, or connected by a VPN, is used.

#### Notes:

- To back up data between LinkStations or TeraStations on a network using jumbo frames, make sure that both devices are configured to use identical (or similar) Ethernet frame sizes. If Ethernet frame sizes are significantly different, the backup job may not be properly performed. In such a case, select the default frame size (1518 bytes).
- You can also specify hostname by a fully qualified domain name (FQDN).

## Configuring a Backup Job

---

### 1 In Settings, click *Backup*.



2 Click  to the right of "Backup".



3 Click *Create New Job*.

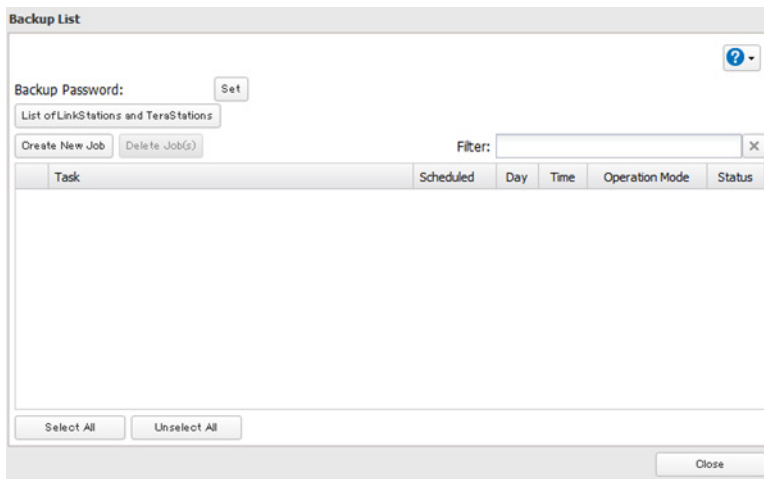

Note: Up to 8 backup jobs can be configured.

4 Select backup settings such as date and time to run.

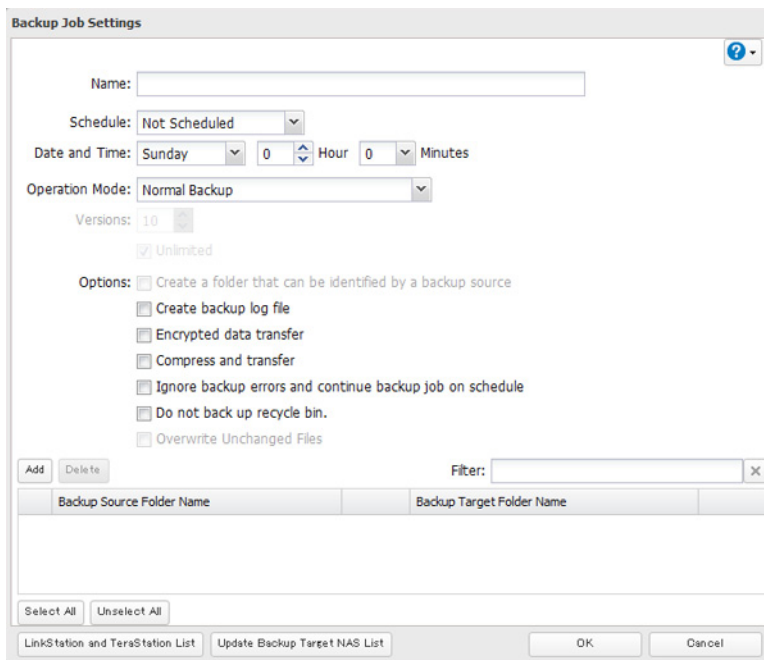

The following types of backup jobs may be selected:

Type	Files included
Normal Backup	All files in the source will be backed up to the destination.
Overwrite Backup (Append Backup)	The first time the backup job runs like a normal backup. In subsequent backups, files added to the source as well as files deleted from the source are kept in the backup folder.
Overwrite Backup (Differential Backup)	The first backup job runs like a normal backup. As each additional backup job runs, files are added to and deleted from the backup folder. The backup destination folder is always the same size as the backup source folder.

Type	Files included
Management Backup	Each time a backup is executed, management information is stored, and only files that have changed are copied or deleted. Data is retrieved from the previous backup file for files that were not changed. This is useful for making backups with limited space or for referencing status at a particular point in time (for use for data snapshot applications).

- 5** Click *Add*.
- 6** Click *Browse* under “Backup Source Folder Name”.
- 7** Select the shared folder that will be the backup source, then click *OK*.

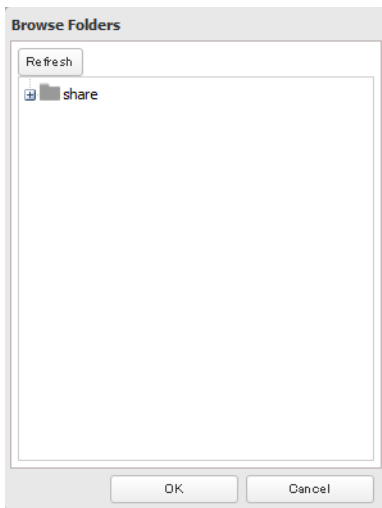

- 8** Click *Browse* under “Backup Target Folder Name”.
- 9** Select the backup target and click *OK*.

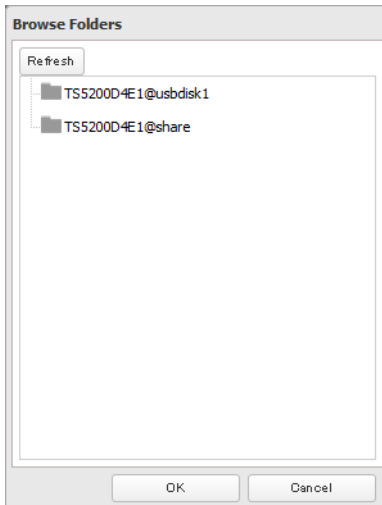

- 10** Click *OK*.  
Tasks added to “Backup List” are displayed.
- 11** Click *Close*.

# Replication

Replication copies all data from a share to a share on a different TeraStation. This is an easy way to configure a reliable system to provide data protection in the event your main TeraStation fails. To configure replication, connect an Ethernet cable to the LAN port of each TeraStation and follow the steps below.

- 1 In Settings, click *Backup*.



- 2 Click  to the right of "Replication".

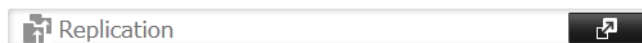

- 3 Click *Edit*.

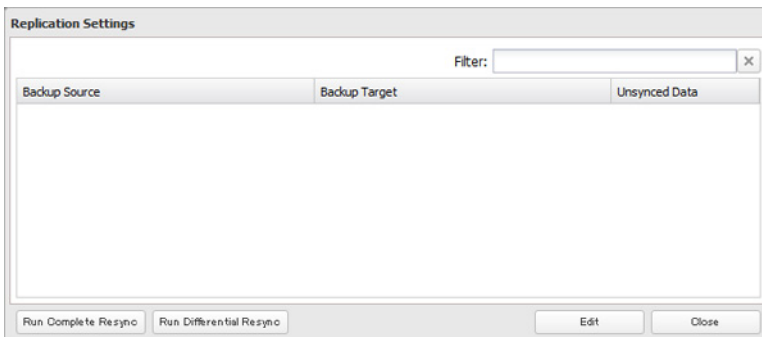

## Notes:

- Files only exist on replication target are deleted when you click *Run Complete Resync*.
- Added files on replication source copied to replication target when you click *Run Differential Resync*. Files only exist on replication target are not deleted.

- 4 Click *Add*.

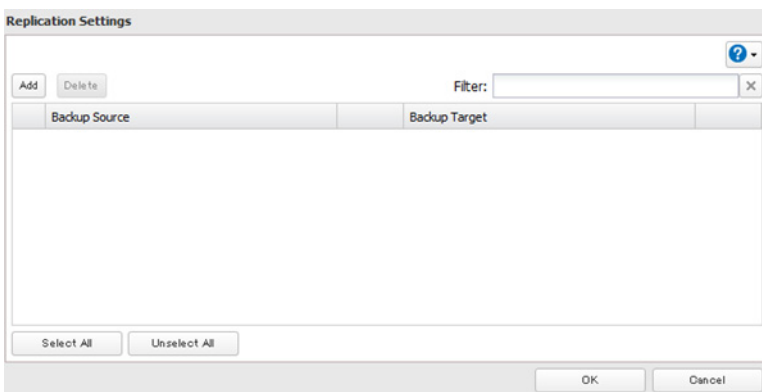

- 5 Click *Add* under "Backup Source".

- 6 Select the shared folder that will be the replication source, then click *OK*.

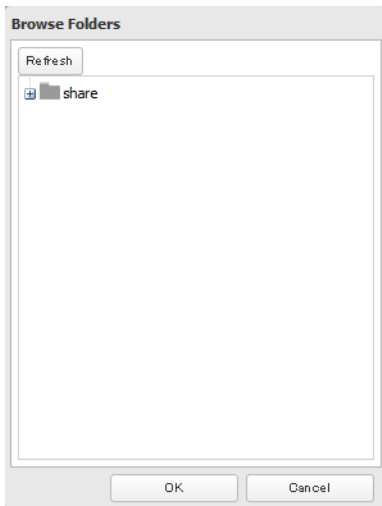

**7** Click *Add* under “Backup Target”.

**8** Select the shared folder that will be the replication target, then click *OK*.

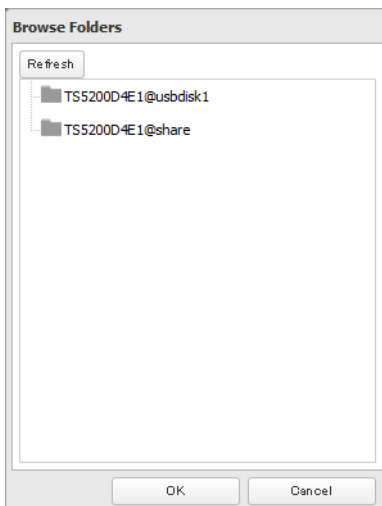

**Notes:**

- A maximum of 64 shared folders can be configured for replication.
- Shared folders with a backup password set cannot be selected as replication targets.
- Replication source data is copied using a differential overwrite to the replication target folder. Note that any data that is not in the replication source will be overwritten.

**9** Click *OK*.

**10** Click *Yes*.

## Failover

With failover, two TeraStations are connected to the network for redundancy. If a problem occurs in the main TeraStation so that it can no longer be accessed, operation is automatically switched to the backup TeraStation.

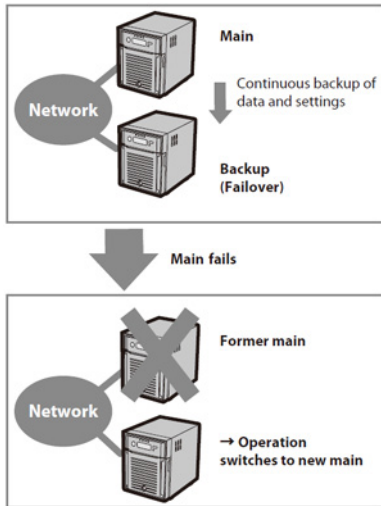

## Ethernet cable connection methods:

Two different configurations for failover are available. With the first setup, if the main TeraStation fails, the backup TeraStation will replace it completely, using the same name and IP address. The backup TeraStation is updated over normal network traffic.

### Connecting to the network at LAN port 1 and setting failover at LAN port 1

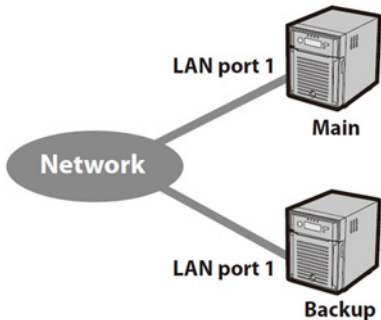

With the second setup, the backup TeraStation and main TeraStation are connected by a second Ethernet cable connecting their LAN 2 ports. Updating is done over this dedicated network path, so updates are quicker and don't interfere with normal network traffic. With this setup, if the main TeraStation fails, the backup TeraStation will replace it by name, but will keep its original IP address.

### Connecting to the network at LAN port 1 and setting failover at LAN port 2

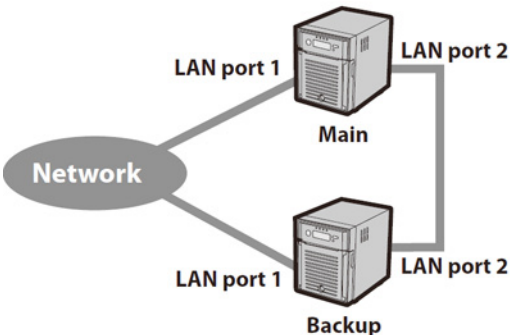

The main and backup TeraStations should be the same model and capacity. Use fixed IP addresses for both TeraStations. Because the IP address of the TeraStation designated as the backup cannot be changed, set its IP address before

configuring failover.

## Using with UPS

Once failover is configured, you cannot set up a UPS for the backup TeraStation. Configure your UPS before configuring failover. UPS recovery can be configured for both the main TeraStation and the backup TeraStation. However, the UPS settings of the main TeraStation will not be copied to the backup TeraStation.

If the backup TeraStation is configured to sync with the UPS connected to the main TeraStation, then if the main TeraStation shuts down, the backup TeraStation will no longer be able to detect if there was a power outage. In this case, move the UPS communication cable from the main TeraStation to the backup TeraStation and reconfigure the UPS link settings.

## Configuring Failover

- 1 In Settings, click *Backup*.



- 2 Open *Failover*.



- 3 Click *Enable Failover*.

- 4 Select a TeraStation to be the target backup device.

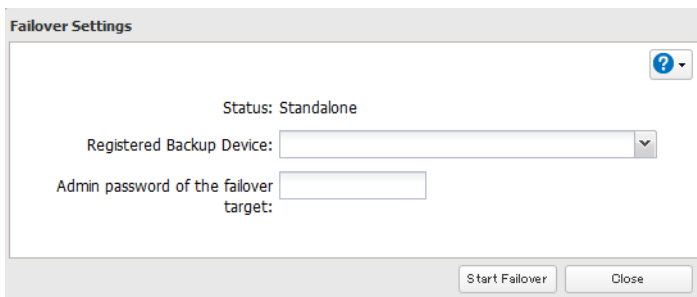

- 5 Enter the administrator password of the target backup device, then click *Start Failover*.

- 6 If the administrator password is correct, the backup TeraStation will beep.

- 7 To accept the settings from the main TeraStation, hold down the function button on the front of the backup TeraStation until it stops beeping.

### Notes:

- If replication is configured for more than one folder, initialize the TeraStation before configuring failover.
- The main TeraStation cannot be used as the backup location for Time Machine.
- If email notification is enabled and failover occurs, navigate to *Management - Email Notification - Edit* in the main TeraStation's settings and click *OK*.



## Maintenance Mode

If failover is configured, change to maintenance mode temporarily before turning off the TeraStation or updating the firmware. Maintenance mode can be enabled and disabled at *Backup - Failover* in the main TeraStation's settings.

## Service IP Address

The "service IP address" will be the new address of the backup TeraStation when it takes over operation from the main TeraStation. If no service IP address is set or a fixed IP address is set, an attempt is made to inherit the IP address set for the main TeraStation.

## Network Problems

If network problems occur, the following messages may appear on the TeraStation's LCD display even though neither TeraStation has failed. If this happens, disable and then reset failover.

- "FailOver I49 LostMainTarget" - This message (I49) is displayed on the LCD panel of the backup TeraStation when operation switches from the main TeraStation to the backup TeraStation.
- "E27: LostBackupTarget" - This message (E27) is displayed on the LCD panel of the main TeraStation if it is no longer able to detect the backup TeraStation on the network.

# Backing Up Your Mac with Time Machine

Time Machine is a backup program included with OS X 10.5 or later. Configure your TeraStation as shown to use Time Machine.

- 1** In Settings, move the AFP switch to the  position to enable AFP.



- 2** Choose *Folder Setup*.



- 3** Choose a shared folder as your backup destination for Time Machine.

- 4** Click *Edit*.

- 5** Select *AFP (Mac)* from *LAN Protocol Support* and click *OK*.

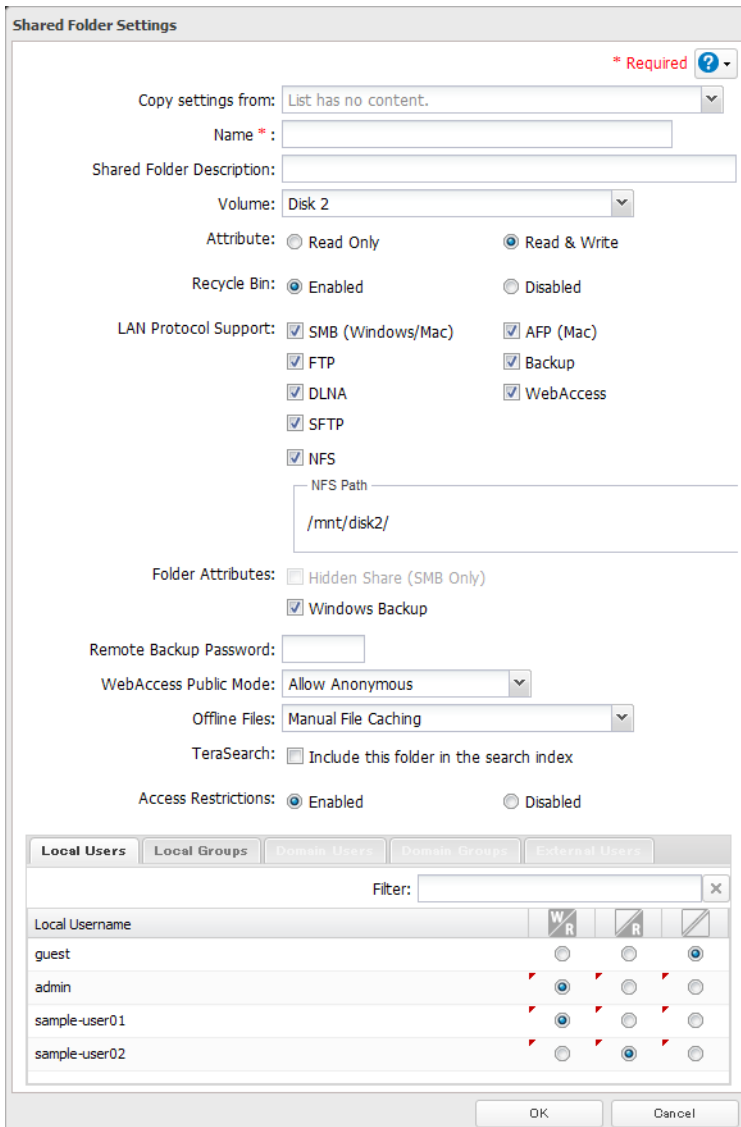

**6** Click *OK*.

**7** Click *Close*.

**8** Click *Backup*.



**9** Click the  icon by "Time Machine".

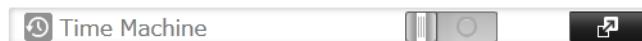

**10** Click *Edit*.

**11** Click *Browse*.



**12** Select the shared folder that you set in the previous step, then click *OK*.



**13** Click *OK*.

**14** Click *OK*.

**15** Move the Time Machine switch to the  position to enable Time Machine.

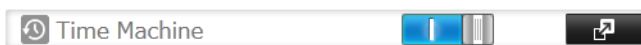

**16** On the Mac, open *System Preferences*.

**17** Click *Time Machine*.



**18** Click *Choose Backup Disk*.



**19** Select the TeraStation, then click *Use for Backup*.

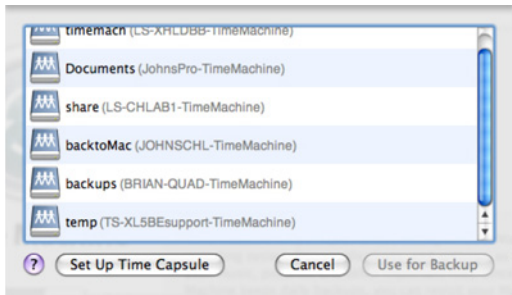

**20** Enter a username and password with the rights to access the shared folder of the TeraStation, then click *Connect*.



**Note:** If access restrictions are not configured on the target share, log in with the administrator account. The default username and password for the administrator account are "admin" and "password". If access restrictions are configured, log in with an account with write privileges.

**21** Time Machine will count down from 120 seconds, and the backup will begin.



# Copy from a USB Device

Use Direct Copy to copy from a USB device directly to the TeraStation.

## These devices are supported:

- USB mass storage devices
- Card readers (except for card readers that can recognize two or more memory cards)
- Digital cameras and other PTP devices
- UPS devices that are specifically indicated as compatible
- USB printers

## These devices are not supported:

- USB hubs
- Mice
- Keyboards

**1** In Settings, enable Direct Copy by sliding the icon from .

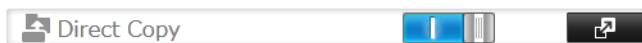

**2** Connect the USB device. The function button will begin to flash.

**Note:** Devices that don't trigger the function button to flash are not supported.

**3** You have 60 seconds to hold down the function button for 3 seconds. This will copy all files from the USB device to the Direct Copy folder of the TeraStation.

### Notes:

- While the function button is flashing, press and release it quickly to cancel Direct Copy.  
For digital cameras that are not in the USB mass storage class, all files in the digital camera are copied.
- To change the Direct Copy target folder, navigate to *Backup - Direct Copy - Edit*, select a new folder, and click *OK*.

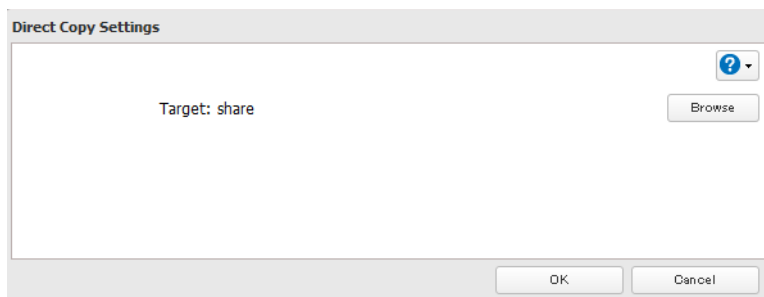

**4** When the copy operation is finished, the access LED of the USB device will stop flashing. Hold down the function button for 6 seconds to dismount the device. The blue LED will go out and the device may be removed safely.

# Amazon S3

Amazon S3 (Amazon Simple Storage Service) is a fee-based online storage service provided by Amazon. Follow the steps below to configure your TeraStation for use with Amazon S3:

**1** Create an account at the Amazon S3 website: <http://aws.amazon.com/s3>

**2** In Settings, click *Web Services*.

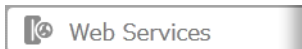

**3** Click the  icon to the right of Amazon S3.



**4** Click *Edit*.

**5** Click *Browse*.

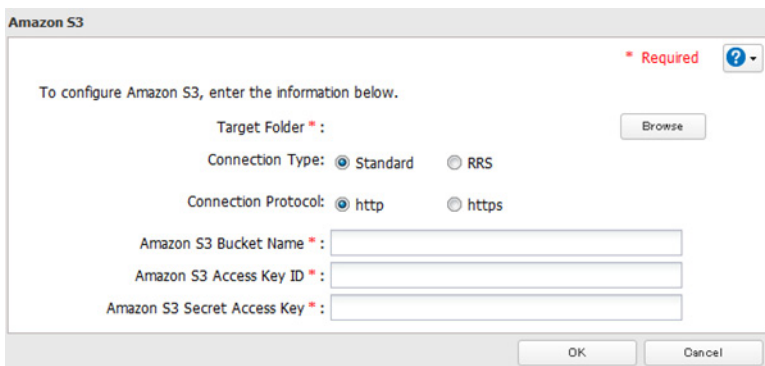

**6** Select the shared folder for remote replication, then click *OK*.

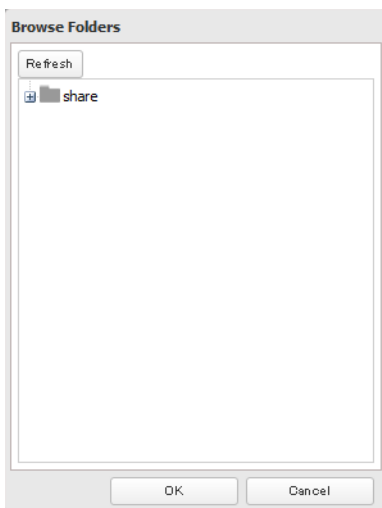

**Note:** This folder is used by Amazon S3. Files are not added to the selected folder and the amount of used space does not increase.

**7** Enter the bucket name, access key ID, and secret access key of the Amazon S3 bucket, then click *OK*.

**8** Click *Close*.

**Notes:**

- Enter the path from the “Target Folder” field in a browser window to access the files saved to Amazon S3.
- To use after the network was temporarily disconnected, click *Remount*.
- To disable Amazon S3, move the Amazon S3 switch to the  position to enable Amazon S3.
- If a file is added to the Amazon S3 bucket from a folder other than the TeraStation’s Amazon S3 remote replication folder, it may take up to an hour for the file to appear in the TeraStation’s Amazon S3 remote replication folder. However, when a file is added to the TeraStation’s Amazon S3 remote replication folder, it immediately appears in the bucket.

# Chapter 6 Remote Access

## WebAccess

WebAccess is a software program for accessing the files in the shared folder of your TeraStation from your computer, smartphone, or tablet through the Internet.

### Notes:

- Be careful when configuring WebAccess. Certain settings can make the files in the shared folder available to anyone on the Internet, without any access restrictions.
- You can also configure WebAccess from Easy Admin.
- Use compatibility mode to use WebAccess with Windows 8.

## Configuration

- 1 Navigate to *File Sharing - WebAccess*.



- 2 Click *Edit*.

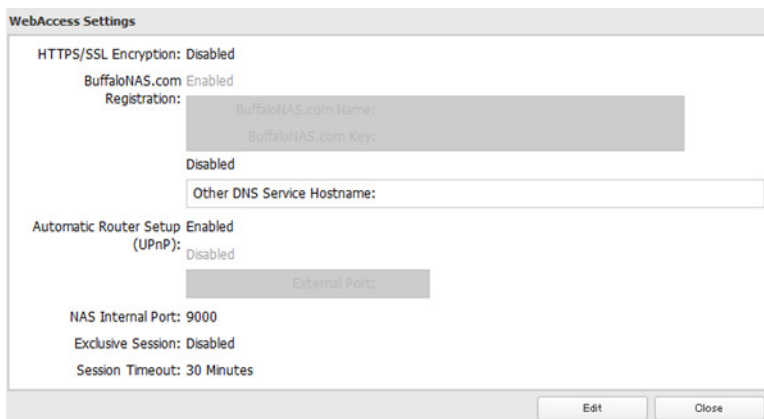

- 3 Configure the desired settings, then click *OK*.



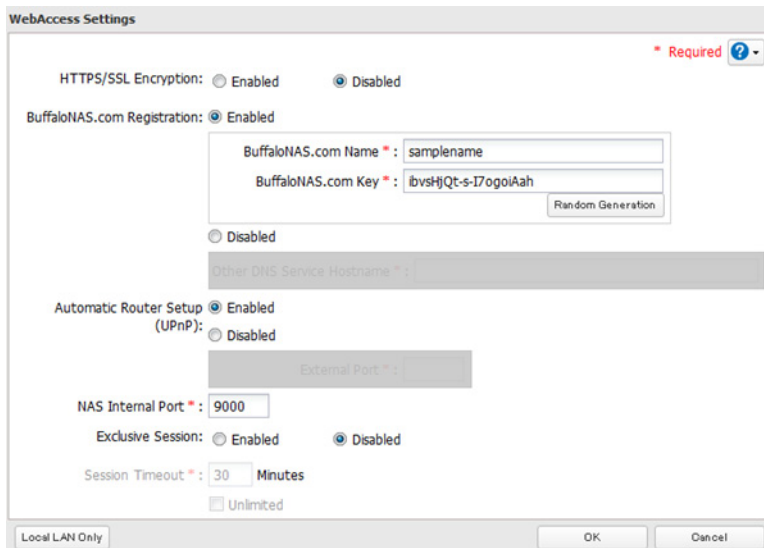

- You may use the default BuffaloNAS.com registration, or disable to use a different DNS server.
- Choose a “BuffaloNAS.com name” for your WebAccess account. Names may use 3 to 20 alphanumeric characters, underscores (\_), and hyphens (-).
- If “Exclusive Session” is enabled, users cannot log multiple computers into WebAccess. Only the last login will be active.
- Enter a time in minutes (1 to 120, or “Unlimited”) before inactive users are logged out of WebAccess.

**4** Click *OK*.

**5** Change the WebAccess switch to the  position to enable WebAccess.

**6** Go to *Folder Setup*.



**7** Select a shared folder to publish.

**Notes:**

- For best results, create a new dedicated share for WebAccess.
- When accessing shared folders through WebAccess from a remote location, the username and password may be required for certain operations. For best results, configure a user account with permissions on the WebAccess share before using WebAccess.

**8** Click *Edit*.

**9** Navigate to *File Sharing - Folder Setup* and choose the folder you will use for WebAccess. Enable “WebAccess LAN protocol support”.

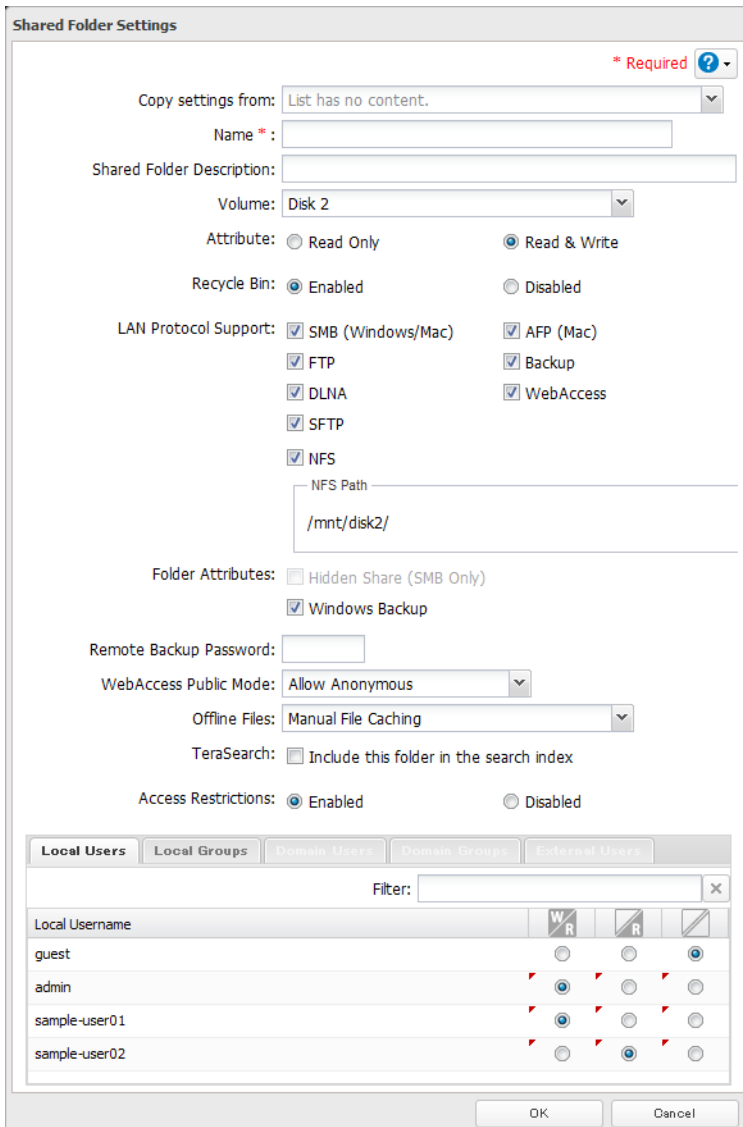

**Notes:**

- The following levels of security are available:  
 Allow Anonymous - Anyone can access (view) shared folders.  
 Allow All Groups and Users - All groups and users registered on the LinkStation or TeraStation can use WebAccess.  
 Use Inherited Folder Permissions - Users and groups have the same access permissions with WebAccess that they do locally. If access restrictions are not set for the shared folder, then this option will not be shown.
- When a user or group can access a folder through WebAccess depends on a combination of WebAccess settings and the shared folder's settings.

Folder Setup	WebAccess Public Mode	Allow Anonymous		Allow All Groups and Users		Use Inherited Folder Permissions	
	Folder Attribute	Read & Write	Read Only	Read & Write	Read Only	Read & Write	Read Only

WebAccess Account	Not Logged in	R	R	-	-	-	-
	Users with Read & Write Access	R/W	R	R/W	R	R/W	R
	Users with Read-Only Access	R/W	R	R/W	R	R	R
	Users Who Belongs to a Group with Read & Write Access	R/W	R	R/W	R	R/W	R
	Users Who Belongs to a Groups with Read-Only Access	R/W	R	R/W	R	R	R
	Users not Included in Any of the Categories Above	R/W	R	R/W	R	-	-

R: Read Only, R/W: Read and Write, -: Cannot Access

**10** There are many ways to access WebAccess folders depending on your device.

- From a computer, supported browsers include Internet Explorer 8, Firefox 3.6, Safari 4, and later.  
Instructions: <http://buffalonas.com/manual/en/>
- Use compatibility mode to use WebAccess with Windows 8 in desktop mode.
- To access from an iPhone, iPad, or iPod touch, install the “WebAccess i” application from the App Store.  
Instructions: <http://buffalonas.com/manual/i/en/>
- To access from an Android device, install the “WebAccess A” application from Google Play.  
Instructions: <http://buffalonas.com/manual/a/en/>
- To access from a Windows Phone, install “WebAccess” from the Marketplace.  
Instructions: <http://buffalonas.com/manual/wp/en/>

## WebAccess Remote

WebAccess Remote enables you to open a shared folder on a remote TeraStation or LinkStation from Explorer, My Computer, or other file manager.

To use WebAccess Remote, the following conditions must be satisfied.

- You have TeraStations or LinkStations in two different locations, such as at home and at a remote location.
- WebAccess is enabled for both devices.

**1** In Settings, click *Web Services*.



**2** Click  to the right of “WebAccess Remote”.

**3** Click *Edit*.

**4** From *Target Folder*, select the shared folder that will be connected.

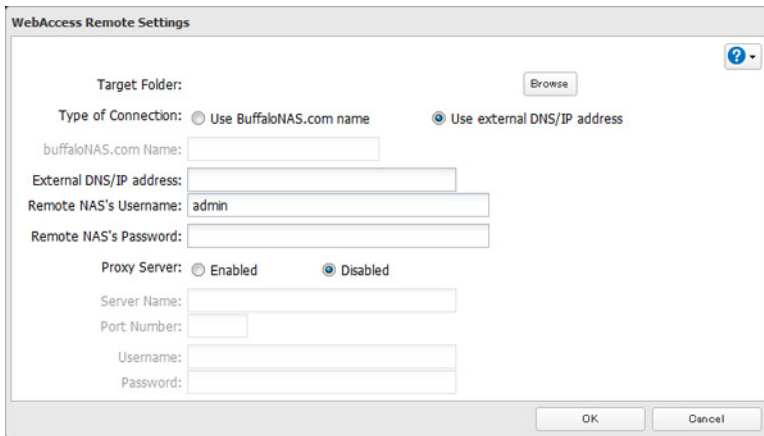

**Note:** The selected folder is used internally by “WebAccess Remote”. Files are not added to this folder and the amount of used space does not increase.

- 5** Select “Use BuffaloNAS.com Name” and enter the BuffaloNAS.com name that is set for the remote TeraStation’s WebAccess.
- 6** Enter the remote TeraStation’s WebAccess username and password.
- 7** Click *Save*.
- 8** You can directly access the shared folder in the remote TeraStation by entering the path displayed in *Target Folder* into the address box in Explorer, My Computer, or other file manager.

**Note:** If using after the network has been temporarily disconnected, click *Remount*.

## FTP

By default, the TeraStation’s shares are only accessible by users connected to the same network or router as the TeraStation. The optional FTP server allows users outside the local network to access the TeraStation.

**Note:** FTP is intended for users who already have FTP client software and have experience with it.

- 1** In Settings, move the FTP switch to the  position to enable FTP.

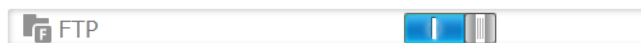

- 2** Open *Folder Setup*.



- 3** Choose a folder to enable remote FTP access on.
- 4** Select read-only or read & write for the shared folder’s attribute, check “FTP” under “LAN Protocol Support”, then click *OK*.

**Shared Folder Settings** \* Required ?

Copy settings from: List has no content.

Name \*:

Shared Folder Description:

Volume: Disk 2

Attribute:  Read Only  Read & Write

Recycle Bin:  Enabled  Disabled

LAN Protocol Support:  SMB (Windows/Mac)  AFP (Mac)  
 FTP  Backup  
 DLNA  WebAccess  
 SFTP  
 NFS

NFS Path:

Folder Attributes:  Hidden Share (SMB Only)  
 Windows Backup

Remote Backup Password:

WebAccess Public Mode: Allow Anonymous

Offline Files: Manual File Caching

TeraSearch:  Include this folder in the search index

Access Restrictions:  Enabled  Disabled

Local Username	W	R	W	R	
guest	<input type="radio"/>	<input type="radio"/>	<input type="radio"/>	<input type="radio"/>	<input checked="" type="radio"/>
admin	<input checked="" type="radio"/>	<input type="radio"/>	<input checked="" type="radio"/>	<input type="radio"/>	<input type="radio"/>
sample-user01	<input checked="" type="radio"/>	<input type="radio"/>	<input checked="" type="radio"/>	<input type="radio"/>	<input type="radio"/>
sample-user02	<input type="radio"/>	<input type="radio"/>	<input checked="" type="radio"/>	<input type="radio"/>	<input type="radio"/>

OK Cancel

### Accessing the TeraStation with an FTP client

- To access the TeraStation via FTP, configure your FTP client software with the following settings:  
 Hostname: IP address of the TeraStation  
 Username: The TeraStation's username  
 Password: The TeraStation's password  
 Port: 21
- Shared folders connected by FTP are available from the "/mnt" directory. The default locations are:  
 For RAID 0, RAID 5, or RAID 1:  
   /mnt/array1/share  
   /mnt/usbdisk1  
   /mnt/usbdisk2  
 For RAID 1 (two arrays):  
   /mnt/array1/share  
   /mnt/array2/share2  
   /mnt/usbdisk1  
   /mnt/usbdisk2  
 For JBOD:  
   /mnt/disk1/share  
   /mnt/disk2/share2

/mnt/disk3/share3  
/mnt/disk4/share4  
/mnt/usbdisk1  
/mnt/usbdisk2

**Accessing the TeraStation with an Anonymous user:**

- To allow anonymous access to your FTP share, disable access restrictions.
- To access the TeraStation via anonymous FTP, configure your FTP client software with the following settings:  
If the TeraStation joins a domain, anonymous users cannot access it.  
Hostname: IP address of the TeraStation  
Username: anonymous  
Password: any character string  
Port: 21

**Notes:**

- If a file was created or copied by AFP, you may not be able to delete it using an FTP connection. If this occurs, use an SMB or AFP connection instead to delete the file.
- For FTP connections, make sure that the total filename including directory path is 250 single-byte characters or less.

# Chapter 7 BitTorrent

BitTorrent is software used to download large files quickly. The information in this chapter is for users who are familiar with BitTorrent.

**Note:** Use compatibility mode to use *Download Manager* with Windows 8.

## Configuration

- 1 In Settings, click *Applications*.

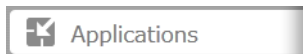

- 2 Click the  icon to the right of "BitTorrent".



- 3 Click *Edit*.

- 4 Click *Browse*.



- 5 Select the shared folder where the downloaded file will be saved, then click *OK*.

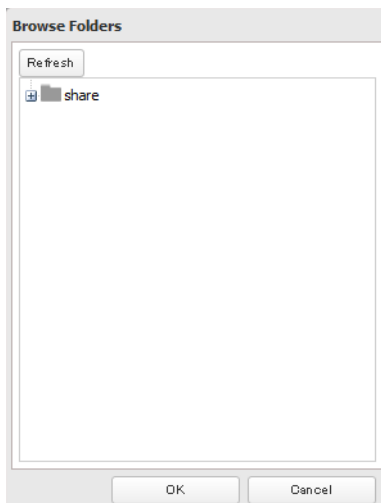

**6** Click *OK*.

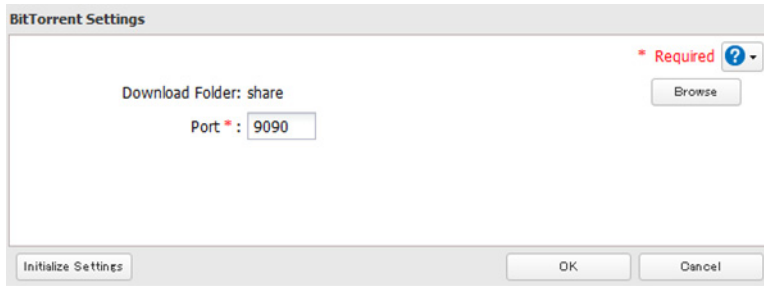

**7** Move the BitTorrent switch to the  position to enable BitTorrent.

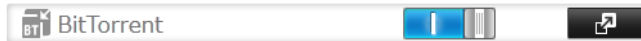

**8** Click  to the right of "BitTorrent".

**9** Click *Open Download Manager*. The default username is "admin" and the default password is blank (no password).

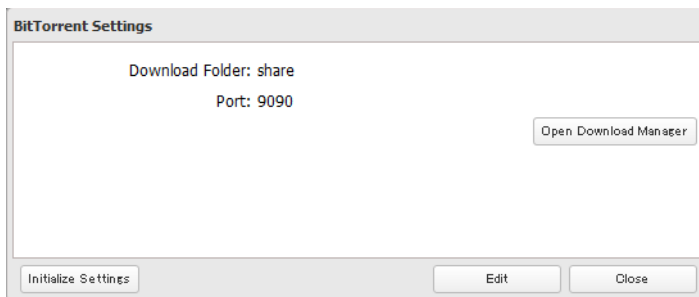

**10** The download manager will open.



# Chapter 8 Multimedia

## DLNA

DLNA is a set of guidelines for sharing digital media. The TeraStation includes a DLNA server compliant with the DLNA guidelines. The movies, photos, and music saved on this product can be played back on DLNA-compliant TVs, stereo equipment, game consoles, and other devices within the network.

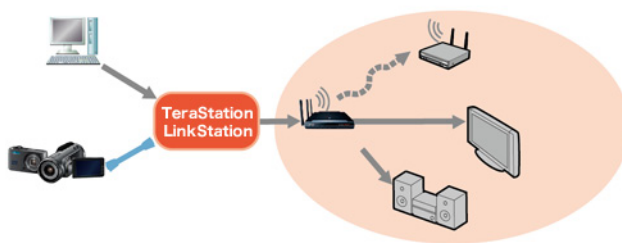

## Configuration

---

- 1 Navigate to *File Sharing - Folder Setup*.



- 2 Select the folder that you want to share with media players and other DLNA-compatible devices.
- 3 Click *Edit*.
- 4 Enable "DLNA" under "LAN Protocol Support", then click *OK*.

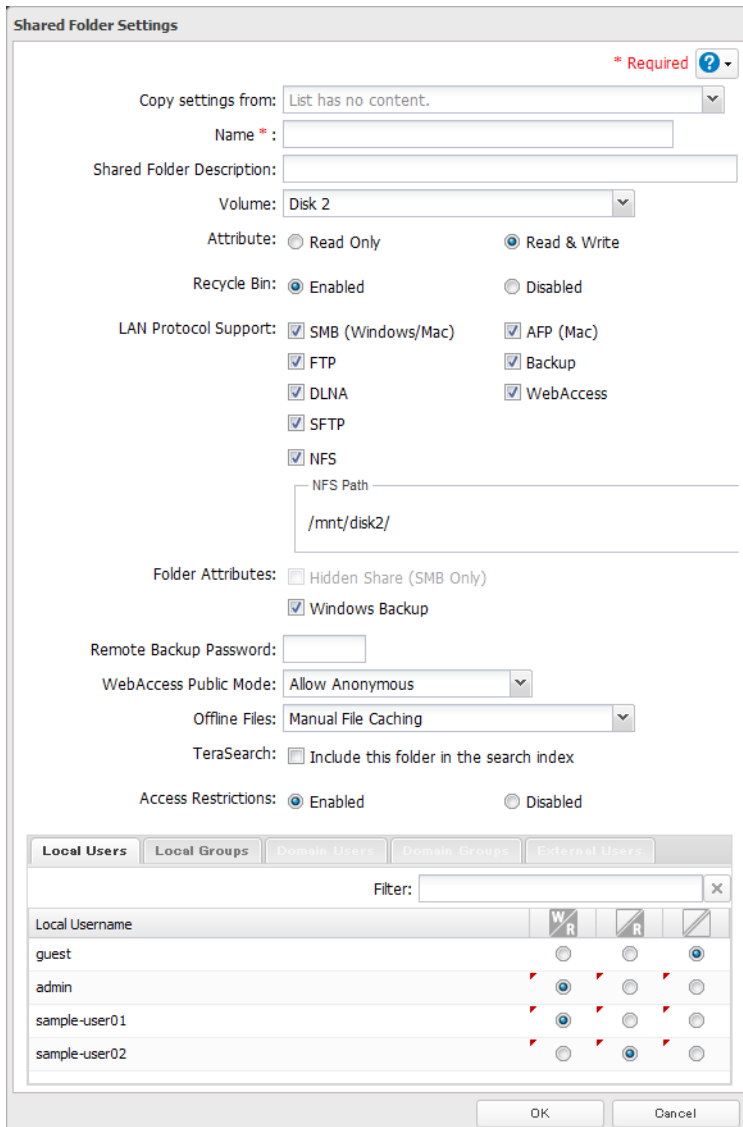

5 Click *Services*.



6 Move the DLNA switch to the  position to enable DLNA.



7 Click the  icon to the right of "DLNA Server".

8 Click *Edit*.

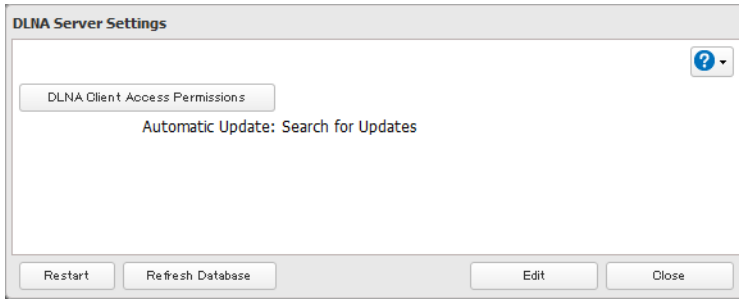

- 9 Select an interval for DLNA server database updates and click *OK*.

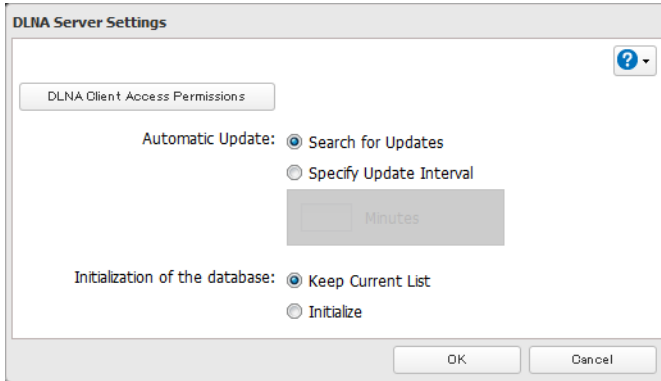

## Playing Files

---

To play back content from a DLNA-compatible device:

- 1 Connect the DLNA-compatible device to the same network as the TeraStation and turn it on.
- 2 Select the TeraStation in the software of the DLNA-compatible device.
- 3 Select the content to be played back.

## Connected DLNA-compatible Devices

---

Follow the procedure below to view the DLNA-compatible devices connected to your TeraStation.

- 1 In Settings, click *Services*.



- 2 Click the  icon to the right of "DLNA Server".



- 3 Click *DLNA Client Access Permissions*.

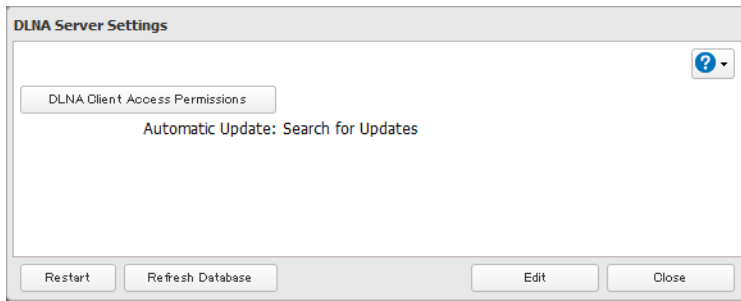

- 4** A list of the MAC addresses, IP addresses, and device names of the DLNA-compatible devices connected to the same network as the TeraStation is displayed. If your device is not listed, click *Refresh Database*.

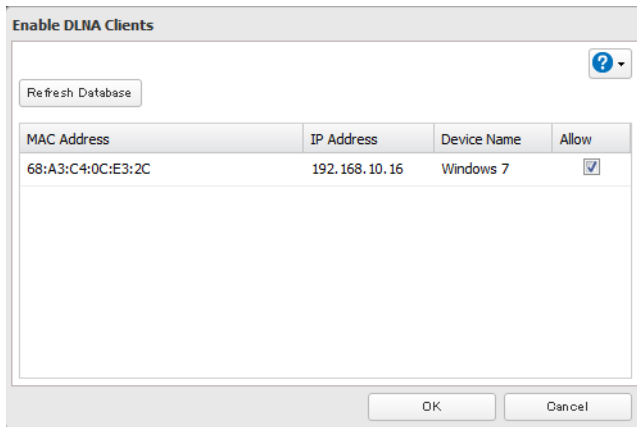

## Streaming to DLNA-compatible Devices

When new movies, photos, and music files are added to the TeraStation's DLNA folder, the database must be updated before the new file can be streamed. By default, the database is updated at startup and again every 60 minutes. You can change this interval or update the database manually.

- 1** In Settings, click *Services*.



- 2** Click the  icon to the right of "DLNA Server", then click *Edit*.

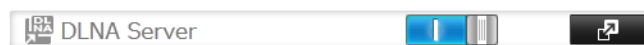

- 3** You may change the update interval, or select *Refresh Database* to update the database immediately.

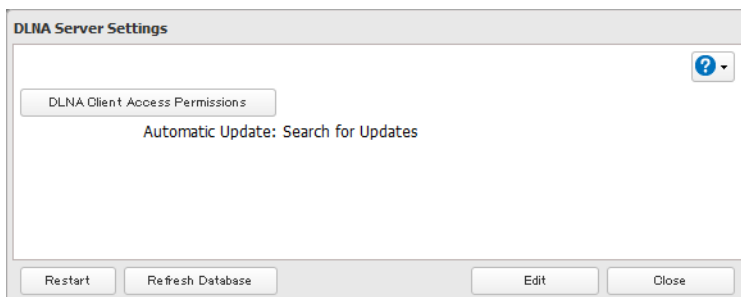

# Disabling Playback from Specific Devices

You may block specific DLNA devices from playing back media content.

- 1 In Settings, click *Services*.

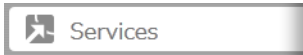

- 2 Click the  icon to the right of "DLNA Server".



- 3 Click *DLNA Client Access Permissions*.

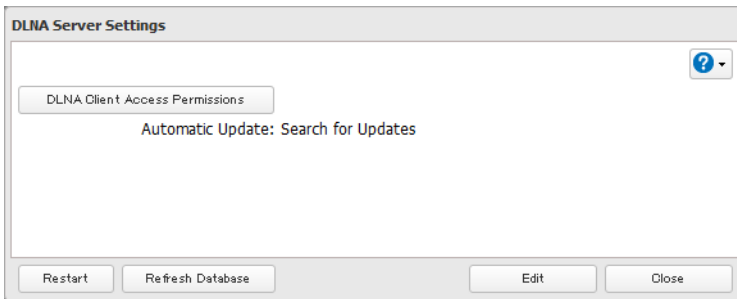

- 4 Uncheck the devices you do not want to allow to play media and click *OK*.

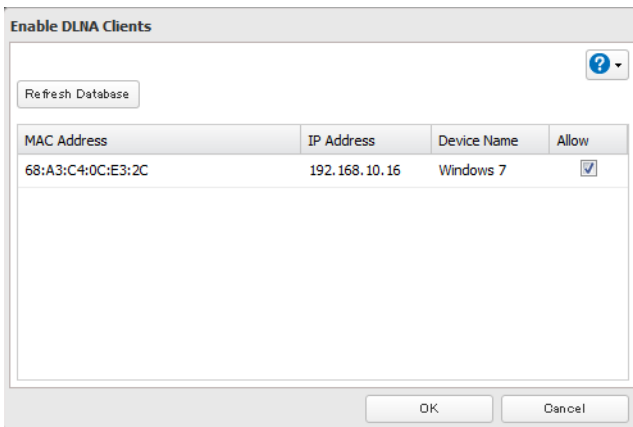

## Supported File Types

The TeraStation supports DLNA streaming of files with the extensions below.

Types	File Extensions
Video files	.avi, .divx, .asf, .mpg, .mpe, .m1v, .vob, .mts, .m2ts, .m2t, .mpeg, .mpeg2, .vdr, .spts, .tp, .ts, .3gp, .mov, .m4v, .wmv, .dvr-ms, .xvid, .mp4, .m4v
Picture files	.jpg, .jpeg, .gif, .png, .tif, .tiff, .yuv, .bmp
Music files	.mp3, .mpa, .wma, .aac, .apl, .ac3, .lpcm, .pcm, .wav, .m3u, .m4a, .mp4, .3gp, .m4b, .aif, .aiff, .flac, .ogg, .mp2, .mp1, .mp4

# iTunes Server

If iTunes server is enabled, computers on your network with iTunes can play music files stored on the TeraStation and transfer them to iPod, iPhone, and iPad devices. The iTunes server supports playback from up to five computers.

## Configuration

- 1 In Settings, click *Services*.



- 2 Click the  icon to the right of "iTunes Server".



- 3 Click *Edit*.

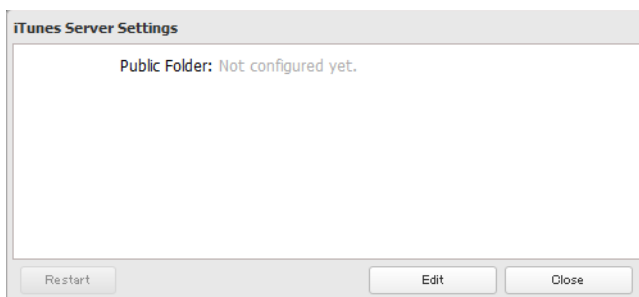

- 4 Click *Browse*.



- 5 Select the shared folder that you want to make available to iTunes, then click *OK*.

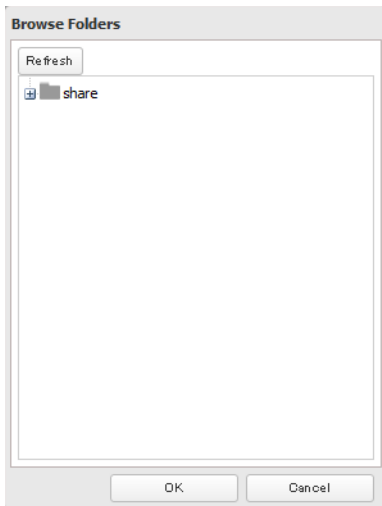

- 6 Click *OK*, then *OK* again.
- 7 Move the iTunes Server switch to the  position.



## Squeezebox Server

Squeezebox is a network music player by Logitech that can play back music stored on your network using your wired or wireless LAN without a computer. Squeezebox supports mp3, flac, ogg, he-aac v2 and wma.

### Configuration

- 1 In Settings, click *Services*.



- 2 Move the Squeezebox Server switch to the  position to enable Squeezebox server.



- 3 Click  to the right of "Squeezebox Server".

- 4 Click *Edit*.

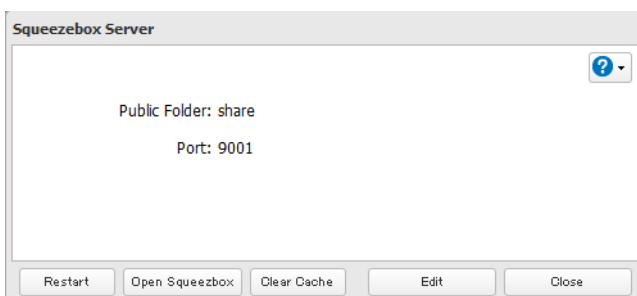

**5** Click *Browse*.

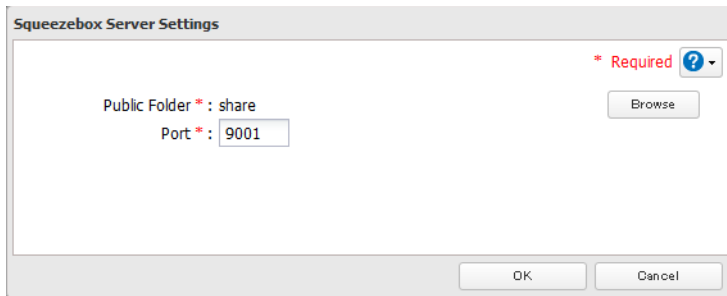

**6** Select the shared folder that you want to make available to Squeezebox, then click *OK*.

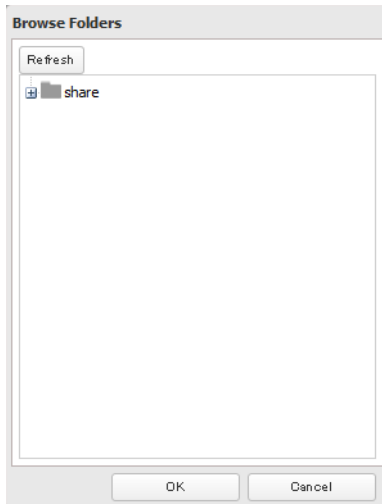

**7** Enter port number (9001 is recommended), then click *OK*.

**8** Click *OK*.

**9** Click *Open Squeezebox*.

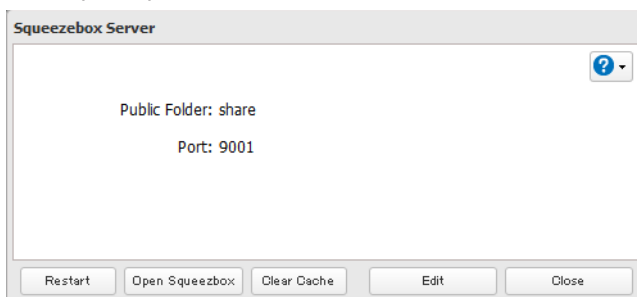

The Squeezebox's settings will open.



# Chapter 9 Surveillance Server

The TeraStation supports streaming video from RTSP (Real Time Streaming Protocol) network cameras.

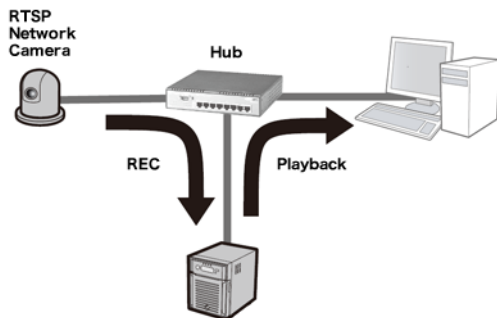

## Getting Started

The following items are required:

- TeraStation with surveillance camera support
- Supported network camera
- Ethernet cable
- Ethernet hub
- Computer

Supported Operation Systems: Windows 8 (64-bit or 32-bit), Windows 7 (64-bit or 32-bit), Windows Vista (64-bit or 32-bit), Windows XP SP 3, Windows Server 2008 SP 2 (64-bit or 32-bit), Windows Server 2003 SP 2, OS X 10.5.8 or later

CPU: Intel Dual-core 2.20 GHz or faster

Hard drive: 10 GB or more of available space

RAM: 2 GB or more

### Live Viewer requirements:

Supported OSs: Windows 8 (64-bit or 32-bit), Windows 7 (64-bit or 32-bit), Windows Vista (64-bit or 32-bit), Windows XP SP 3

CPU: Quad-core 2.33 GHz or faster

Hard drive: 10 GB or more of available space

RAM: 2 GB or more

**Note:** Surveillance cameras cannot be used if failover is configured. Also, failover cannot be used if surveillance camera functionality is enabled. They're just not compatible.

## Installing Client Tools

---

Download the client tools below from [www.buffalotech.com](http://www.buffalotech.com) and install them on your computer.

**Camera Policies** - Registers that a network camera is connected and ready to record.

**Live Viewer** - Lets you view video as it is being recorded. With some network cameras, pan, tilt, zoom, focus, and other remote operations may be unavailable.

**Data Service Policies** - Used to move, back up, and delete recorded video data.

**Vault Admin** - Used to perform license registration, self-diagnosis, check the remaining disk space, and other operations.

**Surveillance Video Manager** - Used to view recorded video data, perform searches, export, and other operations.

**Network Activity** - Displays the operating status of the TeraStation.

### Notes:

- Install after logging into your computer using an account with administrator rights.
- Install another media player to play recorded videos if the version of Client Tools is 5.7.3.2 or later.
- Install VideoLAN VLC media player 1.11~1.13, or Apple QuickTime 7 or later if the version of Client Tools is older than 5.6.19.3. VLC media player 2.0.x may not work with some network cameras. Using VLC media player is recommended if your network camera records MPEG-4 format.
- If VLC media player is installed, use the default installation location (C:\Program Files (x86)\VideoLAN\VLC in Windows 7 64-bit or the Application folder in Mac OS).
- If surveillance cameras or client tools installed under C:\Program Files (x86)\BUFFALO\SurveillanceServer\Bin are blocked due to the OS firewall, refer to the OS help for instructions about how to disable the firewall.
- Install Client Tools on one or more computers connected to the same network as the network camera(s) and the TeraStation. Surveillance camera settings are shared for all cameras on the network.

## Connecting Devices to the Network

---

Connect the following devices to the network.

- A TeraStation that supports surveillance cameras
- A compatible network camera
- A computer with the above client tools installed

### Notes:

- Connect all devices on the same network subnet.
- Set the TeraStation's and network camera's time settings to the correct time. By default, the TeraStation adjusts its clock automatically by using a default NTP server. This NTP Server belongs to Internet Multi Feed Inc. For more information, visit [www.jst.mfeed.ad.jp](http://www.jst.mfeed.ad.jp). You can select a different NTP Server by clicking *Name/Time/Language* on the Management screen. The *Name/Time/Language* screen opens.
- Click *Time*.
- Click *Edit*.
- Uncheck "Use Default NTP Server" and enter a new NTP IP address.
- Click *OK*.

If NTP is not used, disable it and enter the time and date manually. Click *Use Local Date/Time* to import the time and date from your computer.

In certain cases, the DNS server address must be set in order to access the NTP server.

- Use the dedicated utility provided with the network camera or other program to confirm that the network camera operates properly.

# Enabling Surveillance Cameras

---

Enable surveillance cameras in Settings.

**Note:** First, complete the initial settings for the TeraStation and the network camera. For details on the procedure, see the manual supplied with the device.

- 1 In Settings, click *Applications*.

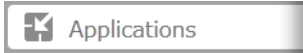

- 2 Click the  icon to the right of "Surveillance Cameras".



- 3 Click *Edit*.

- 4 From "LAN Port", select the LAN port connected to the same network as the network camera and computer where the client tools are installed.



- 5 Click *Browse*.

- 6 Choose a folder for recorded video, then click *OK*.

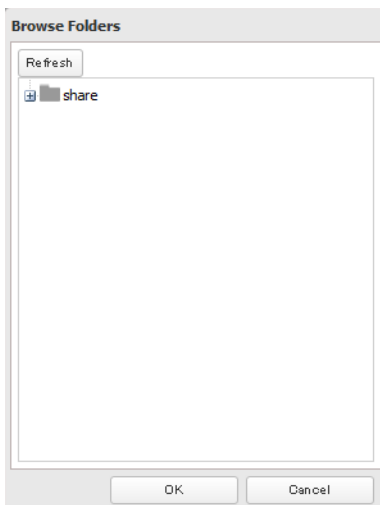

**Note:** Use a folder with at least 100 GB of available space.

- 7 Click *OK*.

- 8 Click *OK*.

- 9 To enable surveillance cameras, change the switch from .



**Notes:**

- If the target shared folder specified as the storage location for recorded video is deleted, the surveillance camera is automatically disabled.
- Do not directly edit recorded video data in the shared storage folder. If a file is directly edited, the surveillance camera software may no longer operate properly.
- Do not duplicate or back up the shared storage folder with the built-in utilities in Settings. A separate backup license must be purchased to back up this data to another TeraStation.
- The client tools can only be used with the LAN connected to the selected LAN port.

### Users with Two or More Network Cameras

In the default settings, only one network camera can be used. To use two or more network cameras, additional licenses (sold separately) must be purchased and registered.

## Enabling the Free License

---

Your TeraStation comes with a license for one surveillance camera. Follow the procedure below to enable the included license.

- 1 Connect the TeraStation to the Internet.
- 2 Click *Start- BUFFALO - BUFFALO Surveillance Server - Vault Admin*.  
For Windows 8, click the *Vault Admin*.
- 3 Select the TeraStation where you want to add the license, right-click it, and click *Properties*.

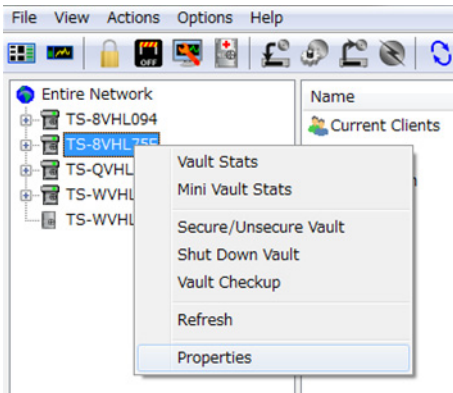

- 4 Open the *License* tab, then click *Activate Free License*.

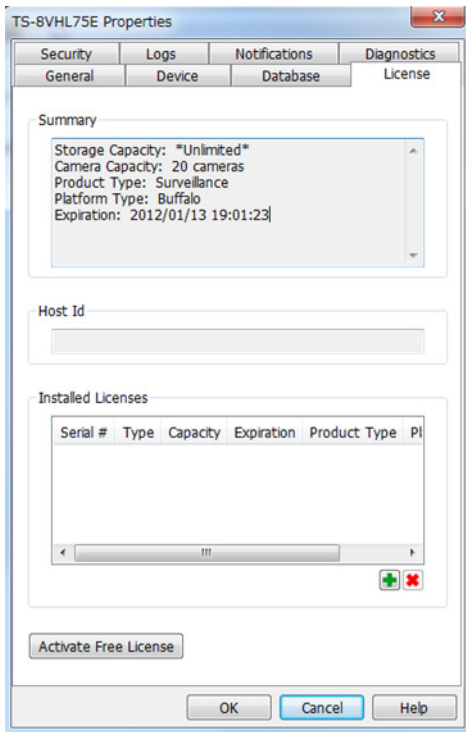

To deactivate the license, click .

**5** Check that the “SurveillanceCamera” and “HardDisk” were added to “Installed Licenses”.

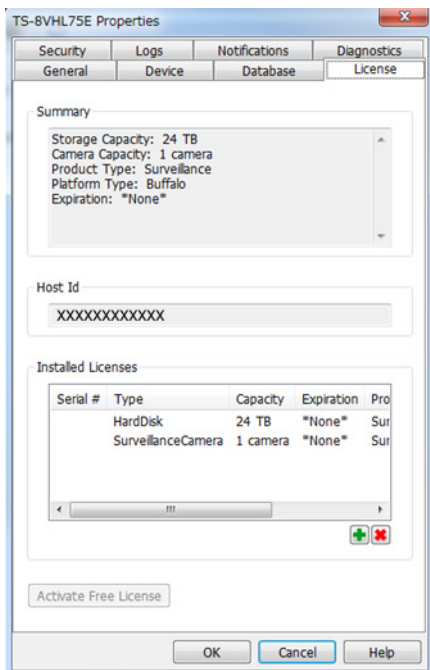

The free license is now enabled.

# Registering Recording Policies

---

Register the network camera that is used.

**1** Click *Start - BUFFALO - BUFFALO Surveillance Server - Camera Policies*.  
For Windows 8, click the *Camera Policies*.

**2** Click the  icon.

**3** Click *Next*.



## Welcome to the Add Camera Wizard

This wizard helps you add and schedule a new camera.  
You may need to run this wizard with administrative rights.

To continue, click Next.

About Help

< Back Next > Cancel

**4** Click *Find Cameras*.



## Camera Information

Find cameras on my network to populate the information below.

Find Cameras

Select the manufacturer and model.

- Select Manufacturer -

- Select Model -

What is the IP Address?

What credentials are needed to access this camera?

User Name:

Password:

Test Camera

Camera Not Listed

Help

< Back Next > Cancel

**5** Select the detected network camera, then click *OK*.

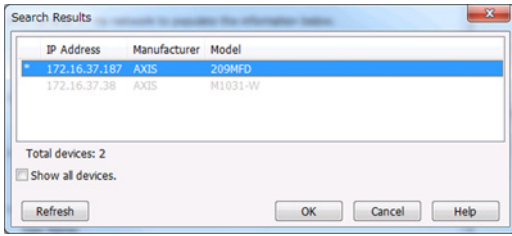

**Note:** Network cameras that are already in use are indicated by an asterisk (\*) and they are gray.

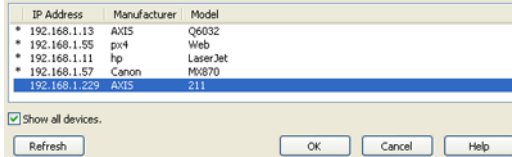

**6** Enter the username and password, then click *Next*.

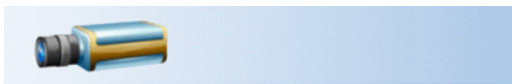

### Camera Information

Find cameras on my network to populate the information below.

Select the manufacturer and model.

- Select Manufacturer -    - Select Model -

What is the IP Address?

What credentials are needed to access this camera?

User Name:

Password:

**Note:** Clicking *Test Camera* runs an operational check of the network camera.

**7** Enter the description, then click *Next*.



### Description

What is the name of this camera? (For example, 'Front Lobby')

Enter a brief description of this camera.

**8** Select the recording schedule, then click *Next*.

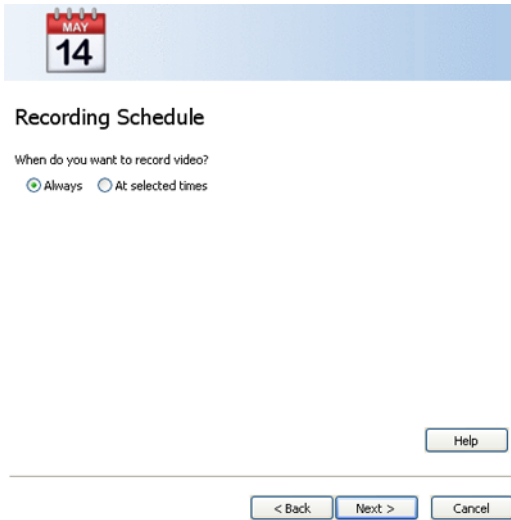

The dialog box features a blue header bar with a calendar icon showing 'MAY 14'. Below the header, the title 'Recording Schedule' is displayed. The question 'When do you want to record video?' is followed by two radio button options: 'Always' (which is selected) and 'At selected times'. At the bottom right, there is a 'Help' button. At the bottom center, there are three buttons: '< Back', 'Next >', and 'Cancel'.

**9** Select the TeraStation where the video will be recorded, then click *Next*.



The dialog box features a blue header bar with a computer monitor icon and a red play button. Below the header, the title 'Recording Computer' is displayed. The question 'What computer will be used for recording video?' is followed by a dropdown menu currently showing '- Select Computer -'. At the bottom right, there is a 'Help' button. At the bottom center, there are three buttons: '< Back', 'Next >', and 'Cancel'.

**10** Check the registration information, and if it is correct, click *Next*.



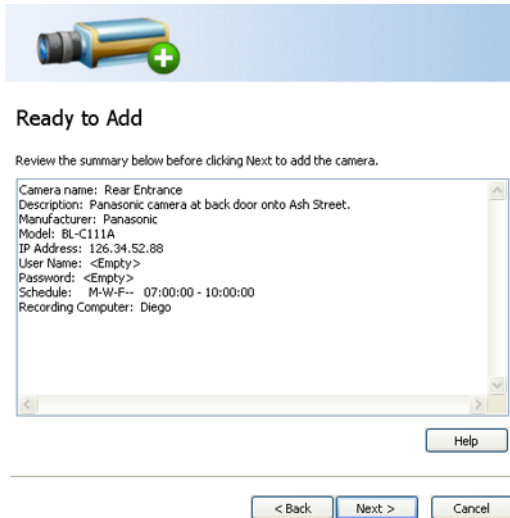

## 11 Click Next.

An additional network camera can be registered by selecting “Yes” when asked “Do you want to add an additional camera?”

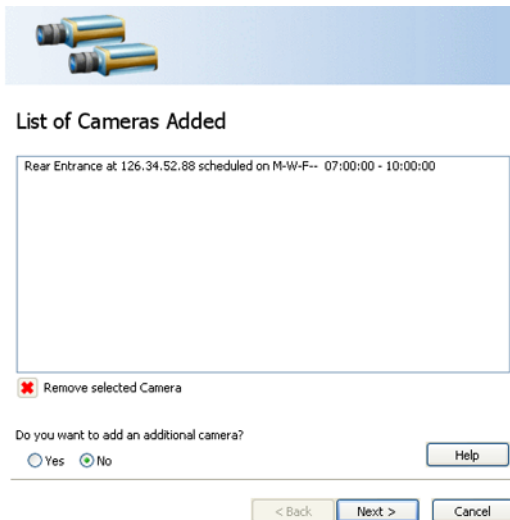

## 12 Click Save.

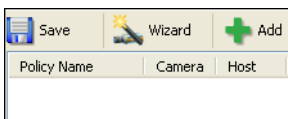

Recording will begin. You’ve now registered the recording policy of the network camera.

## Checking Recording

Wait at least 15 minutes after registering the recording policy before performing this procedure. To check that recording is working correctly, follow the procedure below.

- 1 Click *Start - BUFFALO - BUFFALO Surveillance Server - Surveillance Video Manager*. For Windows 8, click the *Surveillance Video Manager*.

- 2 Click *Search*.

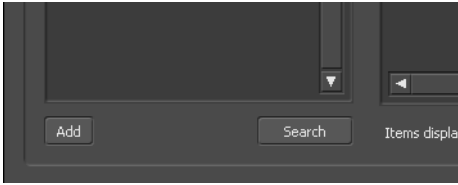

- 3 Recorded video clips are shown in the center of the screen. Click a video clip to start playback.

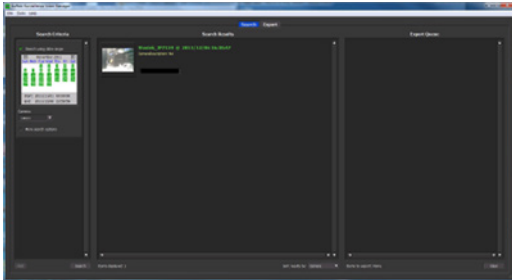

This completes checking recording.

## Email Error Notification

---

You may configure the TeraStation to send you an email notification when the available space for recording is low, or when recording fails due to a camera malfunction, network disconnection, or other cause.

## Configuration

### Viewing Saved Video

---

Follow the procedure below to view recorded data saved in the TeraStation.

- 1 Click *Start - BUFFALO - BUFFALO Surveillance Server - Surveillance Video Manager*.  
For Windows 8, click the *Surveillance Video Manager*.

- 2 Click *Search*.

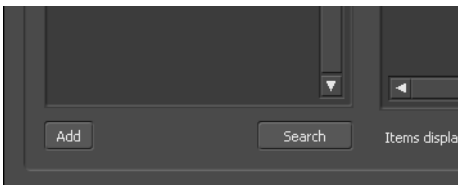

- 3 Video clips are shown in the search results at the center of the screen. Click the clip to start playback.

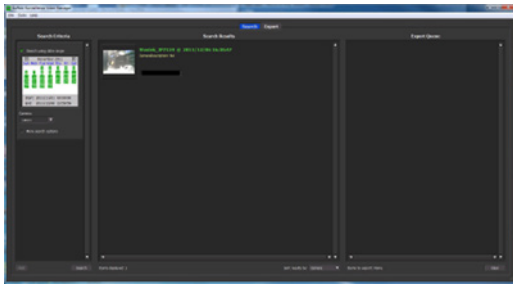

## Export Recorded Data as a MOV Video File

---

To export recorded data saved to the TeraStation as a MOV format video file:

- 1 Click *Start - BUFFALO - BUFFALO Surveillance Server - Surveillance Video Manager*. For Windows 8, click the *Surveillance Video Manager*.
- 2 Select the search criteria on the left side of the search screen, then click *Search*.

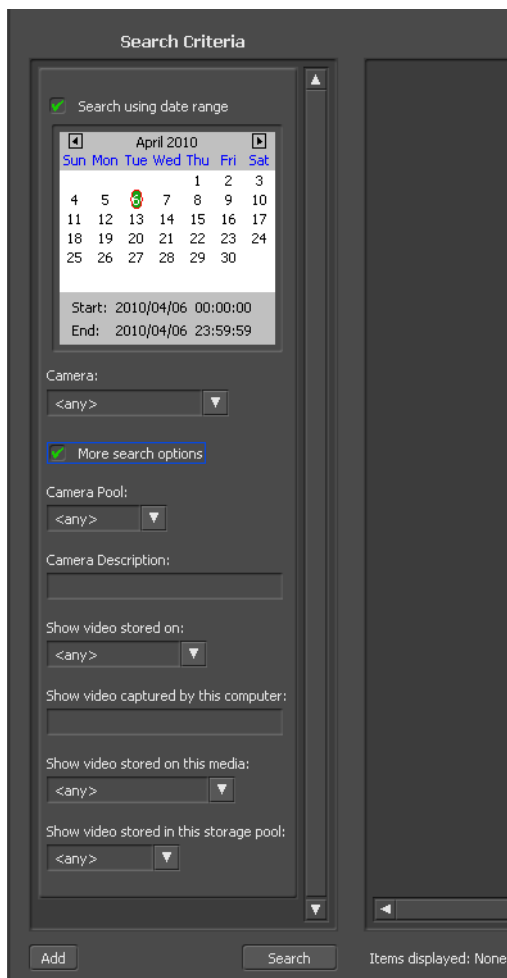

- 3 The search results are displayed. Click a thumbnail to start the media viewer.



4 Select the section to export and click *Export*. This will register the video to the export queue.

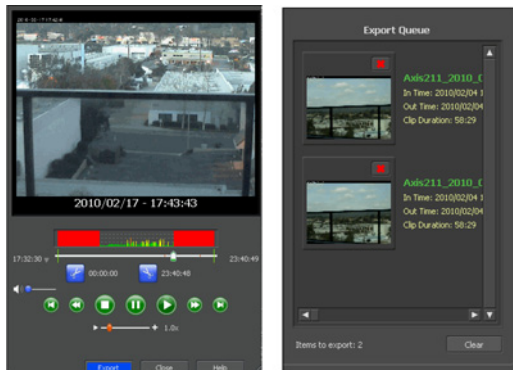

5 Open the Export screen, register the export information from “Export Job Configuration”, and click “Start Export”. The video is exported in MOV format.

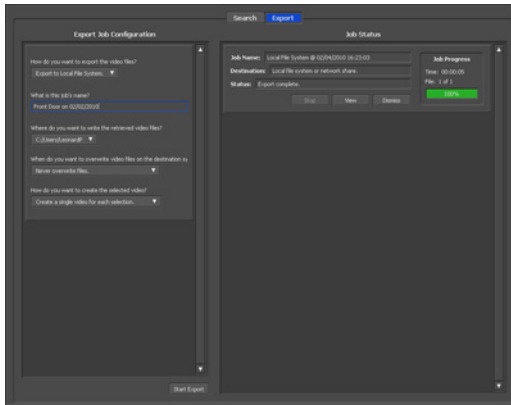

This completes exporting video in the MOV format.

## Viewing Video Real-time

Follow this procedure to view the video as it is being recorded by the network camera.

**Note:** Live Viewer data cannot be viewed.

- 1 Click *Start - BUFFALO - BUFFALO Surveillance Server - Live Viewer*.  
For Windows 8, click the *Live Viewer*.
- 2 Registered network cameras are listed in the Camera folder on the right side of the screen. To view content of a video that is currently being recorded, double-click the camera whose video you want to view or drag to a frame of the camera viewer on the left side of the screen.

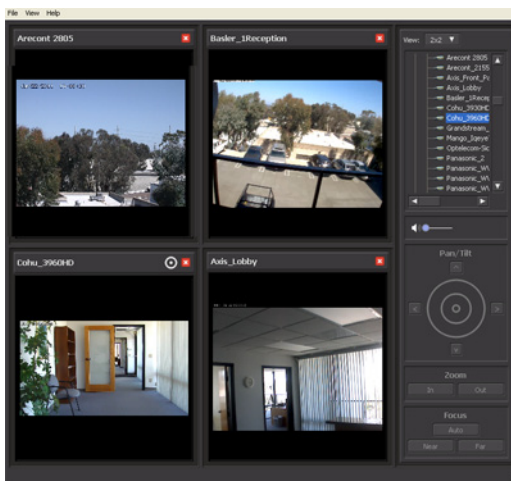

This completes viewing current video.

## Moving Recorded Video Data to Another TeraStation

Follow the procedure below to move (migrate) the recorded video data to another TeraStation.

**Note:** A separate Surveillance Server License Pack must be purchased to do this.

- 1 Click *Start - BUFFALO - BUFFALO Surveillance Server - Data Service Policies*.

For Windows 8, click the *Data Service Policies*.

- 2 Click , and when the Create a Policy screen is opened, enter "MigrateTest" into the "Policy Name" field, select "Migrate", and click OK.

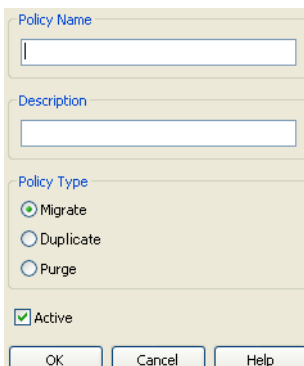

- 3 Click the *Source* tab. Under "Vault", select the TeraStation where the recorded video data is saved. Select "Any" to migrate recorded data on all network-connected TeraStations.

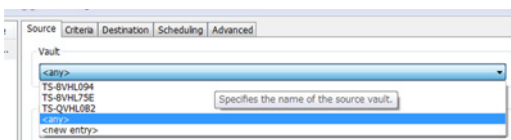

- 4 Click the *Destination* tab to select which TeraStation you want to move the data from "Vault" off of.

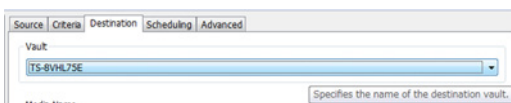

- 5 Set the migration date and time on the "Scheduling" tab. To execute migration every hour, select "Repeatedly at a defined interval" and "Every 1 hour".

- 6 Click , and register the policy.

This completes the settings for moving recorded video to another TeraStation.

## Backing Up Recorded Video to Another TeraStation

Follow this procedure to back up recorded video data to another TeraStation.

**Note:** A separate Surveillance Camera License Pack must be purchased to do this.

- 1 Click *Start - BUFFALO - BUFFALO Surveillance Server - Data Service Policies*. For Windows 8, click the *Data Service Policies*.
- 2 Click , and when the Create a Policy screen opens, enter "DuplicateTest" into the "Policy Name" field, select "Duplicate", and click OK.

- 3 Click the “Source” tab and select the TeraStation where the recorded video data is saved under “Vault”.

**Note:** If “any” is selected, recorded data for all TeraStations connected to the network will be backed up. Click the *Destination* tab, then select the TeraStation where you want to move the data from “Vault”.

- 4 Set the job execution date and time from the “Scheduling” tab. For example, the settings below are made to repeatedly execute the backup job every hour. Select “Repeatedly at a defined interval” and “Every hour”.

- 5 Click , and register the policy.

This completes the settings for backing up video to another TeraStation.

## Automatically Delete Old Data when Space is Low

Follow the procedure below to delete (purge) recorded video starting from the oldest when available space for recording video becomes low.

**Note:** By default, old video data will be deleted automatically when 80% of available space is used. Old data will be removed at the same rate as new video is added, so there will always be enough video to fill about 80% of the total available space. To disable this setting, remove the “Remove Old Video” policy from “Data Service Policies”.

- 1 Click *Start - BUFFALO - BUFFALO Surveillance Server - Data Service Policies*. For Windows 8, click the *Data Service Policies*.
- 2 Click , and when the Create a Policy screen is opened, enter “PurgeTest” into the “Policy Name” field, select “Purge”, and click *OK*.

Policy Name

Description

Policy Type

Migrate

Duplicate

Purge

Active

OK Cancel Help

Click the *Source* tab and select the TeraStation on which recorded video is saved under "Vault".

Source Criteria Destination Scheduling Advanced

Vault

<any>

TS-8VHL094

TS-8VHL73E

TS-8VHL092

<any>

<new entry>

Specifies the name of the source vault.

- 3** Open the *Criteria* tab, and under "Miscellaneous Options", set "Watermark: High" and "Watermark: Low". For example, the settings below delete old data when the amount of used media space exceeds 80% until it drops to 40%. Set Watermark: High to "80" and Watermark: Low to "40".

- 4** Set the job execution date and time from the "Scheduling" tab. In this example, we'll configure a job to execute at 2:00 AM on weekdays.

- Select "On selected days each week".

When should the job run?

On selected days each week.

- Select every day between Monday and Friday.

Days

Sunday

Monday

Tuesday

Wednesday

Thursday

Friday

Saturday

Select All

Deselect All

OK Cancel

- Select "2:00" and "AM", then click OK.

Time

Select Time

2 :00 AM

OK Cancel



**5** Click , and register the policy.

This completes the registration of the policy. The job is executed at 2:00 AM Monday to Friday.

## Changing Where Recorded Video Is Saved

---

Follow this procedure to change the TeraStation to which video is saved.

- 1** Click *Start - BUFFALO - BUFFALO Surveillance Server - Camera Policies*. For Windows 8, click the *Camera Policies*.
- 2** Click the  icon on the tool bar and open the “Camera Configuration” screen.
- 3** Double-click the camera to which video will be saved. This opens “Modify Camera”.

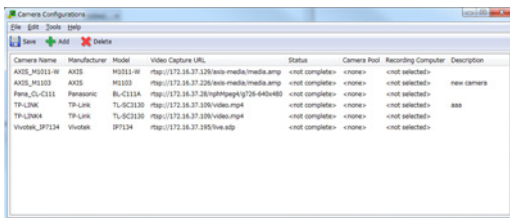

Camera Name	Manufacturer	Model	Video Capture URL	Status	Camera Pool	Recording Computer	Description
AXIS_M1011-W	AXIS	M1011-W	rtsp://172.16.37.129/axis-media/media.amp	<not complete>	<none>	<not selected>	
AXIS_M1013	AXIS	M1013	rtsp://172.16.37.129/axis-media/media.amp	<not complete>	<none>	<not selected>	new camera
Pana_C1-C111	Panasonic	BL-C111A	rtsp://172.16.37.28/ajp/ajp.cgi?D6-646460	<not complete>	<none>	<not selected>	
TP-LINK	TP-LINK	TL-S6210E	rtsp://172.16.37.100/video.mpeg	<not complete>	<none>	<not selected>	aaa
TP-LINK4	TP-LINK	TL-S6210E	rtsp://172.16.37.100/video.mpeg	<not complete>	<none>	<not selected>	
Vivitek_IP7134	Vivitek	IP7134	rtsp://172.16.37.195/live.asp	<not complete>	<none>	<not selected>	

- 4** Select the TeraStation you want to quit using as the “Recording Computer” and click *OK*.

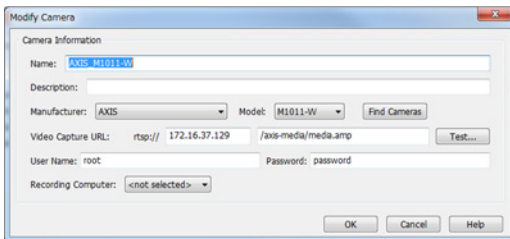

Modify Camera

Camera Information

Name:

Description:

Manufacturer:  Model:

Video Capture URL:

User Name:  Password:

Recording Computer:

**5** Click , and register the policy.

This completes changing the TeraStation where recorded video is saved.

## Client Utilities

### Camera Policies

---

Camera Policies is a software program that registers the network camera that will be used, and starts video recording.

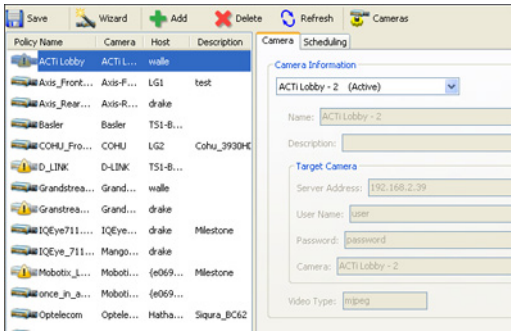

Click  to start the wizard where registration of network cameras and the recording schedule are performed.

Click  to start the camera configuration screen where network cameras are registered.

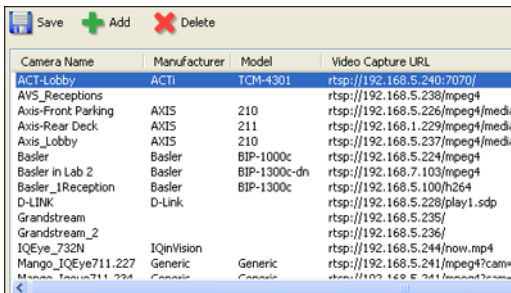

Click  to start a new registration screen for an additional network camera. You can also register the camera and define the recording video policy.

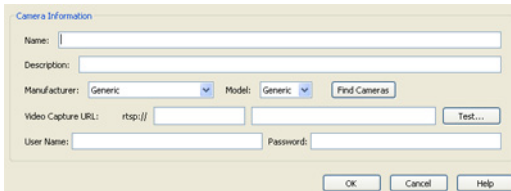

## Live Viewer

Live Viewer allows you to view video currently being recorded by a network camera.

**Note:** To view the current video, the network camera must be registered in Camera Policies.

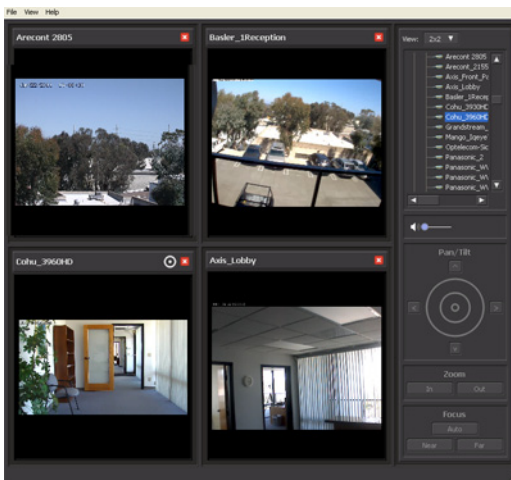

- The layout of the camera view (numbers of rows and columns) and registered network cameras are displayed in the panel on the right side of the screen.

- The camera view (live video) is displayed on the left side panel. In the default setting, a 2x2 camera view is displayed. A layout view with up to 4x4 cameras can be displayed.
- Double-clicking the network camera name or dragging to the camera view frame enables viewing of the current video that is being recorded by the network camera.

The layout can be saved in *View - Save Layout As*.

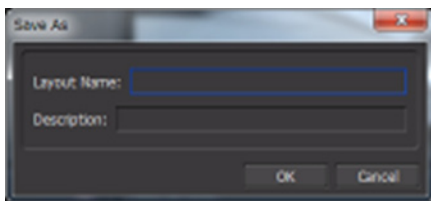

## Data Service Policies

Data Service Policies is a software program for creating data service policies. The policy types that can be created are shown below.

**Note:** To use migration and duplication, a separate Backup License must be purchased.

Policy Type	Action
Migration	Moves recorded video data to another TeraStation
Duplication	Copies recorded video data to another TeraStation and synchronizes the data.
Purge	Deletes the recorded video data.

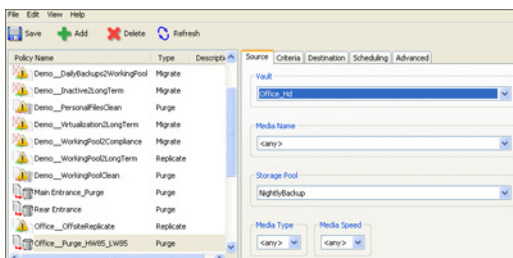

The right side of the screen includes tools for creating and updating data service policies. The left side of the screen shows an overview of all data service policies.

### Notes:

- If  is displayed for a policy in the left-side frame, the policy is disabled.
- Surveillance server functionality must be enabled beforehand for the TeraStation where migration or duplication files will be saved.

## Vault Admin

Vault Admin is a software program for managing surveillance camera resources.

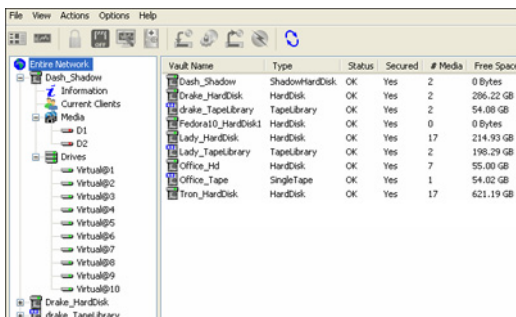

Operations are performed from the tool bar located in the top section of the screen.



The icons and their functions are shown below.

Icon	Description
	Starts "Mini Vault Status" for enabling the display of basic monitoring information.
	Sets the security status.
	Shuts down or restarts a portion (Vault) of the surveillance cameras.
	Changes the properties.
	Performs a diagnosis of the surveillance camera.
	Loads a media device.
	Prepares a media device.
	Unloads a media device.
	Erases a media device.
	Refreshes the current screen.

## Surveillance Video Manager

Surveillance Video Manager is a software program for performing searches and exporting of recorded video data.

### Search Window

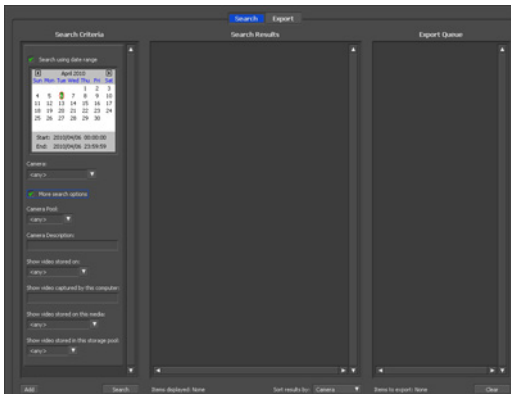

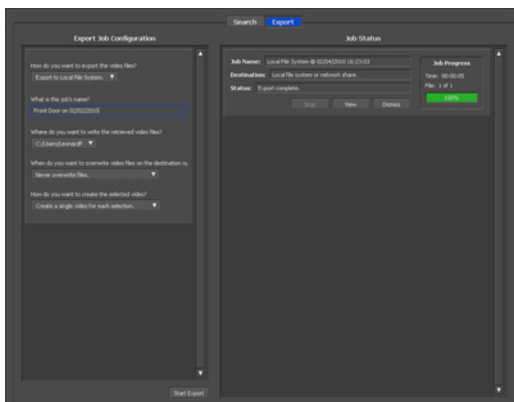

## Export Window

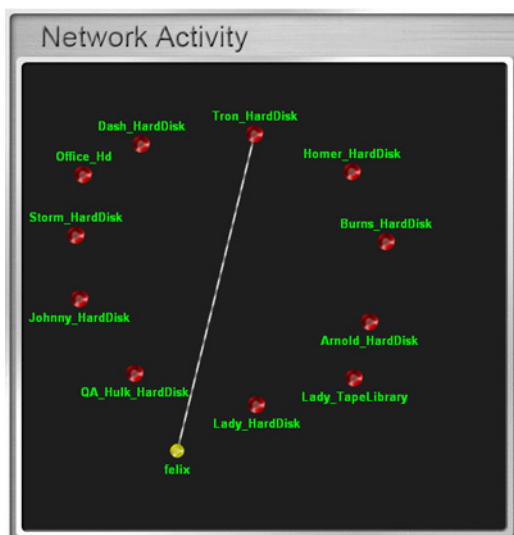

## Network Activity

Network Activity is a software program that displays the TeraStations on which surveillance cameras are operating on the network, in real time and in graphical form.



All clients and TeraStations located on the network are indicated by  and labels. These can be moved by dragging and dropping them. Clients are displayed only when a job is being executed and activities are indicated by a line linking the client and TeraStation.

## Mini Vault Stats

Double-clicking the icon for a TeraStation on "Network Activity" starts "Mini Vault Stats". "Mini Vault Stats" shows the network traffic in graphical form.

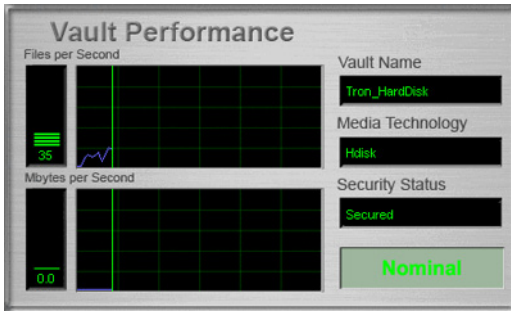

## Activating Additional Licenses

Purchasing an additional license (sold separately) enables you to connect and use two or more cameras and use the migration and duplication functions. Use this procedure to activate an additional license.

### When the TeraStation is Connected to the Internet

- 1** Click *Start - BUFFALO - BUFFALO Surveillance Server - Vault Admin*.  
For Windows 8, click the *Vault Admin*.
- 2** Select the TeraStation to which you want to add the license, right-click it, and click *Properties*.

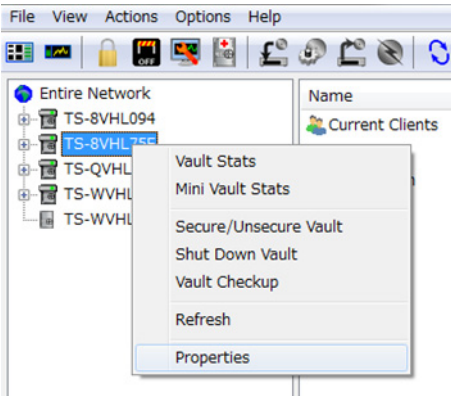

- 3** Open the *License* tab, then click +.

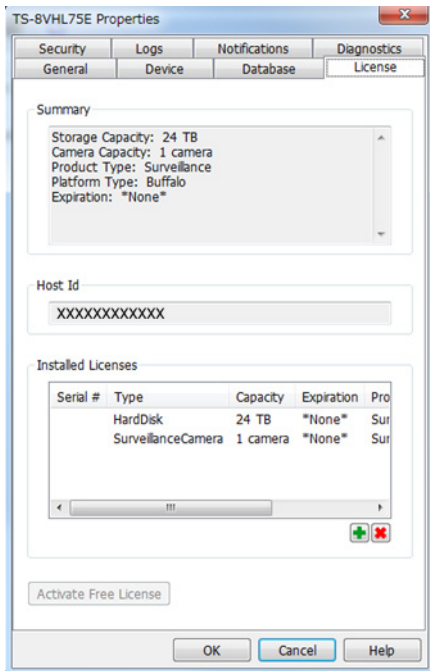

If your default free license activation is not installed, see “Enabling the Free License” to install it.

- 4** Enter the product key for the license pack (sold separately), then click *OK*.

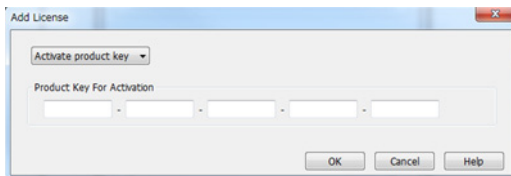

- 5** Confirm that the new license was added to “Installed License”.

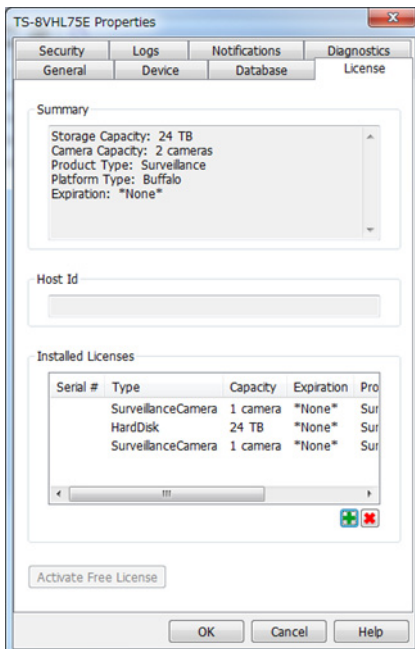

You have now activated the additional license.

# TeraStation Not Connected to the Internet

- 1 If the TeraStation is being used in an environment where Internet access is not available, a separate computer with access to the Internet is required to activate the additional license.
- 2 Click *Start - BUFFALO - BUFFALO Surveillance Server - Vault Admin*.  
For Windows 8, click the *Vault Admin*.
- 3 Select the TeraStation where you want to add the license, right-click it, and click *Properties*.

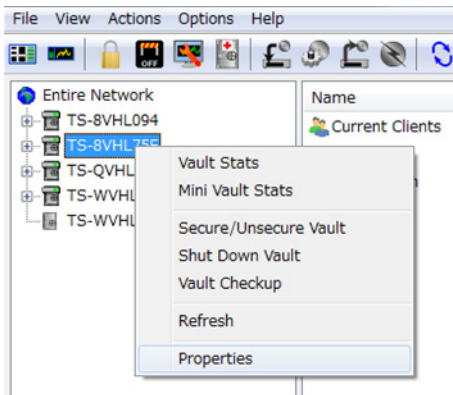

- 4 Open the *License* tab, then make a note of the "Host Id".

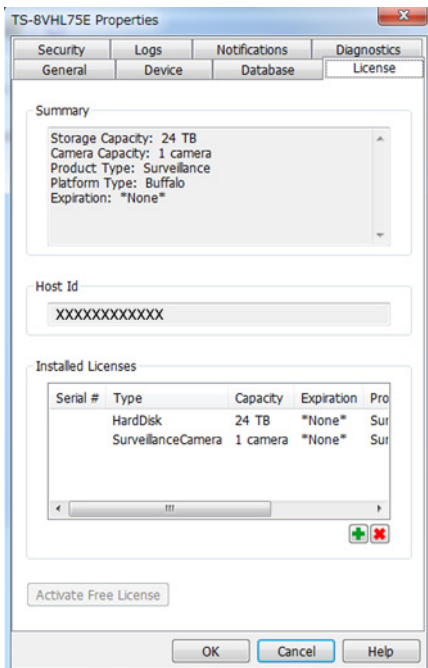

- 5 Open the website below in web browser.  
[http://buffalo.jp/support\\_s/camera\\_licence/](http://buffalo.jp/support_s/camera_licence/)
- 6 From the license pack (sold separately), enter the product key and host ID code and click "Activate Software License".



Indicates a required field

**Activate Buffalo Surveillance Server Software**

By filling out the product key and registration information below, you will receive a valid license file to manually activate your Buffalo Surveillance Server software. The license file will then need to be imported into the software using the Buffalo Surveillance Server Vault administrator application.

**NOTICE:** You should *only* need to complete this process below if you are unable to activate your software directly from the Phoenix Vault Administrator application.

Product Key Information

Please enter your Product Key as XXXXX XXXXX XXXXX XXXXX XXXXX

Product Key:  -  -  -  -

Your Host ID number is obtained from the License Properties tab within the Vault Administration application.

Host ID Code:  

I have read and Accept the [Software Application Terms and Conditions](#).

- 7** Downloading of the license file (\*.lic) begins. Save the license file to a USB memory device or other storage device.
- 8** Copy the license file to a computer connected to the same network as the TeraStation.
- 9** In the computer connected to the same network as the TeraStation, click *Start - BUFFALO - BUFFALO Surveillance Server - Vault Admin*.  
For Windows 8, click the *Vault Admin*.
- 10** Select the TeraStation to which you want to add the license, right-click, and click *Properties*.

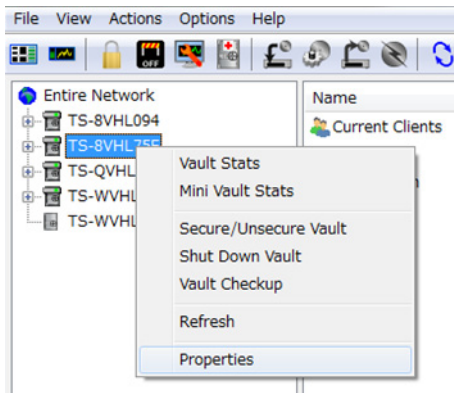

- 11** Open the *License* tab, then click +.

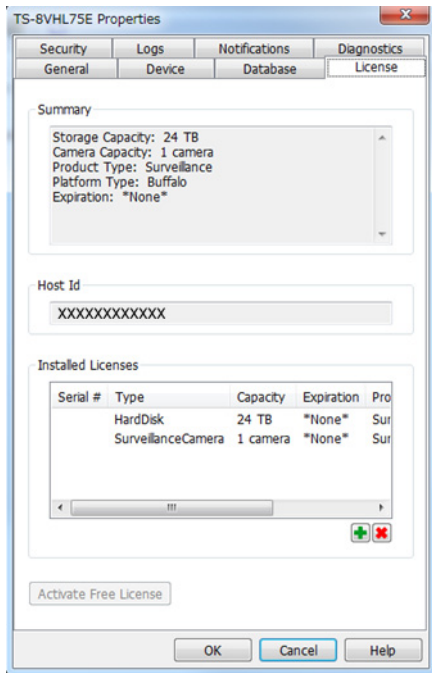

**12** Select "Import license file", then click *Browse*.

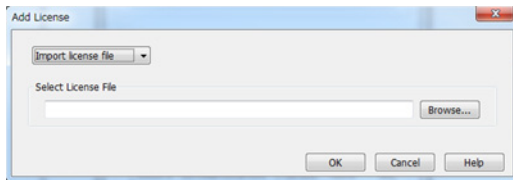

**13** Select the license file that was saved before, then click *OK*.

**14** Check that the license pack was added to "Installed Licenses".

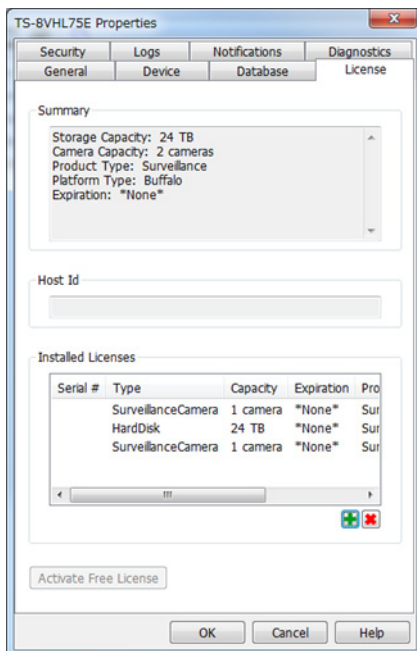

This completes authentication of an additional license.

## Troubleshooting

Issue	Possible Cause	Possible Solution
Video recording does not start.	Surveillance Camera setting not enabled.	Enable the Surveillance Camera from Settings.
	A LAN cable between the TeraStation and network camera is disconnected, or the power is turned off.	Check that the LAN cables are inserted correctly.
	The video recording policy is not registered.	Register the video recording policy from Camera Policies.
	The device is not connected to a network on the same LAN, or the device is not connected to the LAN port that was set in Settings.	Connect the device to the network of the LAN port that was set in Settings.
	The disk is full.	Free available space on the disk by moving or deleting files.
	The time for the TeraStation and network camera is not correct.	Set the time in Settings.
	There are not enough camera licenses for the network cameras.	Purchase and register an additional license.
I cannot enable the surveillance camera.	Failover is running.	Disable failover.
Surveillance cameras no longer record video.	The target shared folder for the recorded video was deleted.	Enable surveillance camera functionality in the Admin interface.
I cannot view the network camera using Live Viewer.	The network camera is not registered in some camera policies.	Register the network camera from camera policies.
	There is an error in the network camera settings.	Verify the settings in the camera policies.
There is no recorded data, or the recorded data cannot be found.	A camera was added in camera policies while Surveillance Video Manager was running.	If this is the case, this video may not be accessible. Restart Surveillance Video Manager to enable searching for recorded video from the new camera.

### Notes:

- QuickTime is a trademark of Apple Inc., registered in the U.S. and other countries.
- VLC media player is a trademark of Video LAN org.
- See [www.buffalotech.com](http://www.buffalotech.com) for supported cameras.
- Refer to the "Buffalo Surveillance Server Administrator's Guide" for information about client tools.

# Chapter 10 Advanced Features

## Antivirus Software

Trend Micro NAS Security™ can protect your network and data from software viruses, malware, and spyware. To use Trend Micro NAS software, purchase an OP-TSVC license pack (sold separately). If your TeraStation includes activated antivirus software, no license registration is necessary.

### Notes:

- To use the antivirus software effectively, the TeraStation should be connected to the Internet. The connection can be routed through a proxy server if the appropriate settings are configured in *Administration - Proxy Settings* from the left-side menu of the Trend Micro NAS Security settings page.
- Trend Micro is a registered trademark of Trend Micro Incorporated.

## Activating Virus Scanning

---

Follow the procedure below to activate virus scanning.

- 1 In Settings, click *Applications*.

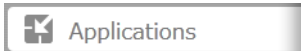

- 2 Change the icon to the right of "Antivirus" from .



A quarantine folder named "TMNAS" is automatically created on the TeraStation. If a virus is detected, viruses are moved to this folder.

## Configuring Security Settings

---

To configure Trend Micro NAS Security, follow this procedure.

- 1 In Settings, click *Applications*.

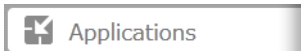

- 2 Click the  icon to the right of "Antivirus".

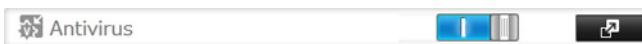

- 3 Click *Options*.



4 Enter your username and password, then click *Log On*.



LOGON

Please type your user name and the password to access the web console.

User name:

Password:

You can log on with the TeraStation's admin account.  
**The default username and password are "admin" and "password".**

5 Trend Micro NAS Security settings will open.

**System Information**

Product version: Trend Micro NAS Security 1.0 - build\_1059

Scan Results for Virus: 0 viruses/spyware detected today.

Summary	Today	Last 7 days
Virus undetectable	0	4
Virus quarantined	0	4
Virus deleted	0	0
Virus passed	0	0
Virus cleaned	0	0
Virus renamed	0	0

**Scan Status**

Real-time Scan: Enabled (Incoming files)  
 Scheduled Scan: Disabled  
 Manual Scan:

**Update Status**

Component	Current Version	Last Updated
<input checked="" type="checkbox"/> Virus Pattern	7.271.00	2010-02-22 10:09:23
<input checked="" type="checkbox"/> Spyware/Grayware Pattern	0.943.00	2010-02-22 10:09:23
<input checked="" type="checkbox"/> Scan Engine	9.200.1001	2009-11-16 17:11:05

## Connecting through a Proxy Server

If you must pass through a proxy server to connect to the Internet in your network environment, follow this procedure to set the IP address of the proxy server and other settings.

1 From the left-side menu, click *Administration - Proxy Settings*.

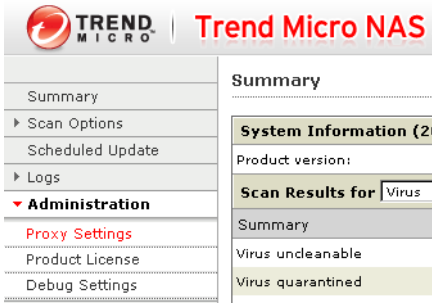

- 2 Check "Use a proxy server to access the Internet (License update)". Enter the IP address and port of the proxy server, then click *Save*.

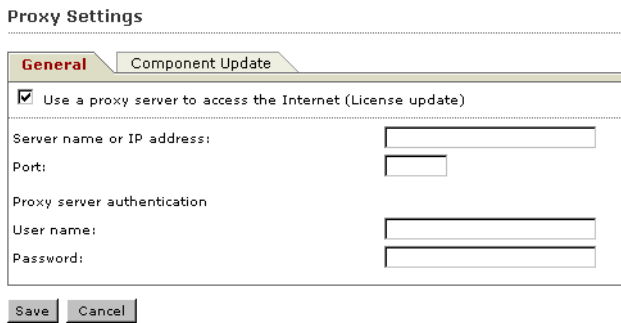

The antivirus software is now configured to use a proxy server.

## Licenses

If the antivirus software on your TeraStation is not activated or has expired, please purchase an OP-TSVC license pack (sold separately). If your TeraStation includes activated antivirus software, no license registration is necessary. The total period for antivirus software updates may be extended up to 5 years.

This example shows an initial 1-year period for updates extended by an additional year.

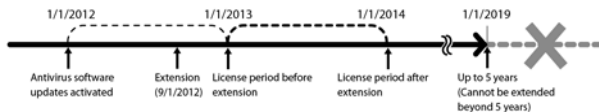

**Note:** It's not possible to register a serial number that would extend the total license period beyond 5 years, such as a second 3-year license after 3 years.

- 1 From the left-side menu, click *Administration - Product License*.

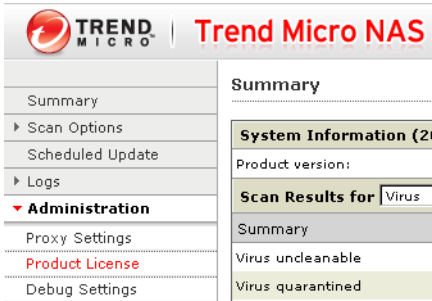

- 2 Enter the serial number from the "Trend Micro NAS Security™ License Pack Guide", included in your package. Click *Activate*.

## Product License

[Help](#)

Please enter the new serial number to activate your product.

New Serial Number	
Product:	Trend Micro NAS Security 1.0
Current serial number:	abod - abod - abod - abod - abod
New serial number:	<input type="text"/> - <input type="text"/> - <input type="text"/> - <input type="text"/> - <input type="text"/>

The new license is now registered.

To check the status of the current license, open the Trend Micro NAS Security settings page and navigate to *Administration - Product License* on the left-side menu.

## Updating

For best results, configure your antivirus software to update automatically as described below.

- 1 From the left-side menu, choose *Scheduled Updates*.



- 2 Check "Enable Scheduled Update".

### Scheduled Update

[Help](#)

Enable Scheduled Update

Update Frequency	
Start time:	<input type="text" value="00"/> : <input type="text" value="00"/> (hh:mm)
Repeat interval:	<input type="radio"/> Hourly <input checked="" type="radio"/> Daily, update for <input type="text" value="2"/> hours

- 3 Select a time for updates to begin, an interval for updates, and an amount of time for updates to continue. Select the components to update. Click *Save*.

Enable Scheduled Update

**Update Frequency**

Start time: 12 : 00 (hh:mm)

Repeat interval:

Hourly

Daily, update for 2 hours

Weekly, every Monday  
update for: 4 hours

**Components to Update**



<input checked="" type="checkbox"/> Component	Current Version	Last Updated
<input checked="" type="checkbox"/> Virus Pattern	7.271.00	2010-02-22 10:09:23
<input checked="" type="checkbox"/> Spyware/Grayware Pattern	0.943.00	2010-02-22 10:09:23
<input checked="" type="checkbox"/> Scan Engine	9.200.1001	2009-11-18 17:11:05

Save Cancel

The antivirus software is now configured to update automatically at the scheduled time. Updates will not be downloaded if the TeraStation is turned off, in standby mode, or disconnected from the Internet.

## Excluding a Specific Folder from Antivirus Scanning

By default, all folders on the TeraStation (including attached USB drives) will be scanned. Follow the procedure below to block specific shared folders from being scanned.

- 1 In Settings, click  to the right of "Folder Setup".
-  Folder Setup 1 Folder(s) 
- 2 Click the shared folder that you want to remove from the scan, then click *Edit*.
  - 3 Uncheck items to exclude from the scan, then click *OK*.

Shared Folder Settings : buffalo

Volume: Disk 1

Attribute:  Read Only  Read & Write

Recycle Bin:  Enabled  Disabled

LAN Protocol Support:

SMB (Win/Mac)  AFP (Mac)

FTP  Backup

DLNA  WebAccess

SFTP

NFS

— NFS Path —

Folder Attributes:  Hidden Share (SMB Only)

Windows Backup

Remote Backup Password:

WebAccess Public Mode:

Offline Files:

TeraSearch:  Include this folder in the search index

Virus Scan:  Real Time Scan

Real Time Scan

Manual Scan

OK Cancel



# Virus Scanning

---

Three types of virus scans are available:

## Real-time Scan

The virus scan runs in the background, scanning every file that you read or write. This is the default type of scanning. Your TeraStation may run slower if real-time scanning is enabled.

## Scheduled Scan

A scheduled scan is executed at specific regular intervals, such as every Tuesday at 3 am.

## Manual Scan

A manual scan runs once when initiated. Initiate a manual scan as described below.

- 1 From the left-side menu, choose *Scan Options - Manual Scan*.



- 2 Click *Scan now*.

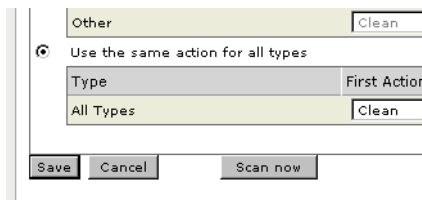

This starts the virus scan.

**If the scan finds a virus, the user can be notified in two ways:**

- The message "Virus alert I34" is normally shown on the LCD panel. Once the virus is removed from the quarantine folder, the message is no longer displayed. If the antivirus software is configured to delete viruses from the quarantine folder automatically, then "Virus alert I34" will not be displayed.
- If email notification is enabled In Settings, then the antivirus software notifies the user by email if a virus is found. Setting email notification is recommended.

**Depending on how many files are on your TeraStation, a virus scan may take several hours. Estimated scanning times are shown below.**

- 10,000 files: ~ 30 minutes
- 100,000 files: ~ 5 hours
- 1,000,000 files: ~ 50 hours

# Checking the Log

---

Follow the procedure below to check the virus scan log.

- 1 From the left-side menu, choose "Logs".



**2** Click the log item that you want to check.

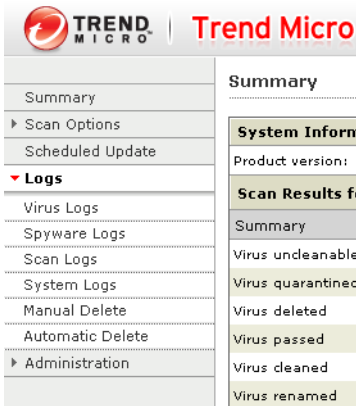

**3** Click *Display Log*.

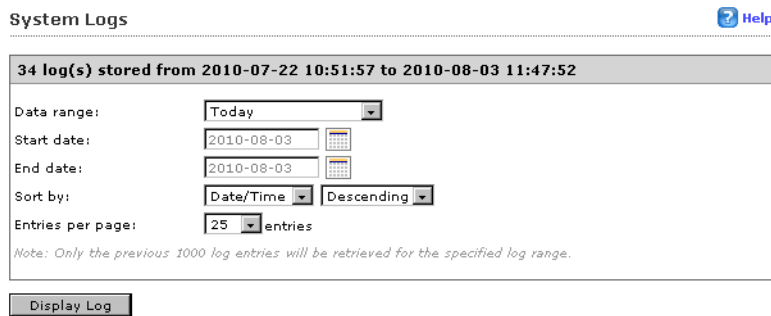

This completes the procedure for checking the log.

## Online Help

For more information on the antivirus software, refer to the online help. Follow the procedure below to access the online help.

**1** From the right-top menu, choose *Help - Contents and Index*.

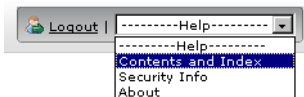

**2** Online help will open.

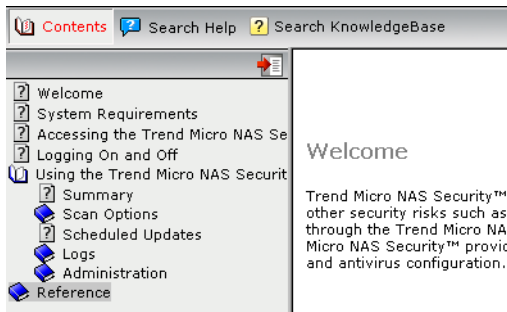

Online help is now ready to use.

## Email Notification

Your TeraStation can send you email reports daily, or when settings are changed or an error occurs. Notification emails may be triggered by any of the following events:

- Backup job completed
- Change to RAID configuration
- RAID error
- Fan error
- Hard drive read error
- Hard drive replacement
- Quota exceeded

**1** In Settings, click *Management*.

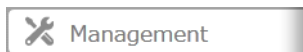

**2** Move the Email Notification switch to the  position to enable Email Notification.



**3** Click  to the right of "Email Notification".

**4** Click *Edit*.

**5**

Enter your mail server settings and choose what events will trigger notification. Click *OK* to send a test email.

## Sleep Mode

To save energy, you can specify times to put the TeraStation into standby mode, where the hard drive and LEDs are turned off.

- 1 In Settings, click *Management*.



- 2 Click  to the right of "Sleep Timer".



- 3 Click *Edit*.

- 4 Specify the timer interval, start time, and end time, then click *OK*.

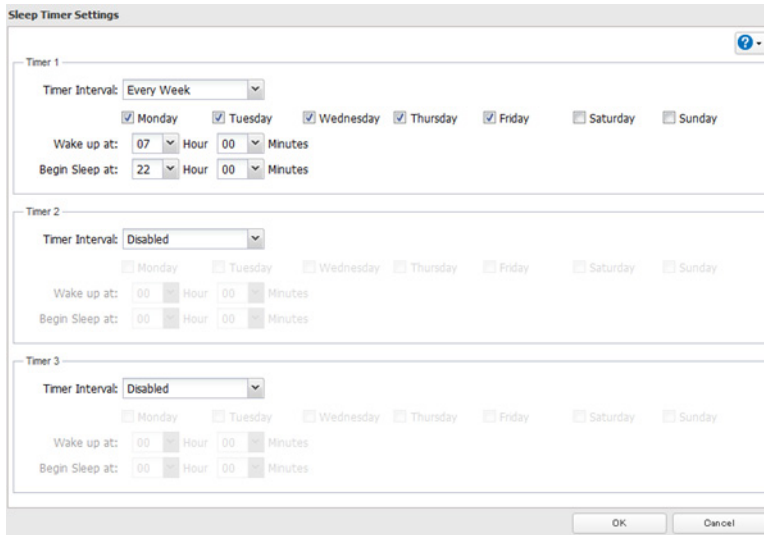

**Notes:**

- Up to three timers can be set.
- The end time can be set from 0:00 to 27:45.  
The start time can be set from 0:00 to 23:45.  
If the end time is after 24:00, the start time setting may be from 4:00 to 23:45.  
24:00 refers to 0:00 of the next day and 27:00 refers to 3:00 of the next day.
- The end time should not be set at the same time as or before the start time.
- If a backup task is scheduled during a disk check, disk format, backup job or within 5 minutes of the current time, the TeraStation will not change to standby mode when the end time is reached.
- If the scheduled times in the timer overlap, operation is performed using the widest time interval.
- Examples of multiple timer settings are shown below.

**Example 1:**

If running at a current time of 10:00 Wednesday

Timer 1: Every day 12:00-24:00

Timer 2: Not used

Timer 3: Not used

No operation is performed at 12:00, and operation changes to standby mode at 24:00.

**Example 2:**

When running at a current time of 10:00 Wednesday

Timer 1: Everyday 9:00-18:00

Timer 2: Selected day of the week Wednesday 10:00-20:00

Timer 3: Not used

On days other than Wednesday, operation is started at 9:00, and operation changes to standby mode at 18:00.

On Wednesday, operation changes to standby mode at 20:00.

**Example 3:**

If running at the current time of 10:00 Wednesday

Timer 1: Every day 9:00-18:00

Timer 2: Selected day of the week Wednesday 10:00-25:00

Timer 3: Not used

On days other than Wednesday, operation is started at 9:00, and operation changes to standby mode at 18:00.

On Wednesday, operation starts at 9:00, and it changes to standby mode at 1:00 the next day.

Example 4:

When running at a current time of 10:00 Wednesday

Timer 1: Every day 9:00-18:00

Timer 2: Selected day of the week Wednesday 7:30-22:00

Timer 3: Not used

On days other than Wednesday, operation is started at 9:00 and operation changes to standby mode at 18:00.

On Wednesday, operation starts at 7:30 and changes to standby mode at 22:00.

- To turn on the TeraStation before the startup time but after operation was ended by the sleep timer, press the power button on the TeraStation. This switches from standby mode to power-on mode.

## Wake-on-LAN

The TeraStation supports Wake-on-LAN, which allows it to be turned on remotely.

- 1 In Settings, click *Network*.

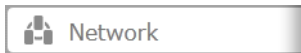

- 2 Click the  icon to the right of "IP Address".



- 3 Click *Change*.

- 4 Enable "Wake-on-LAN", then click *OK*.

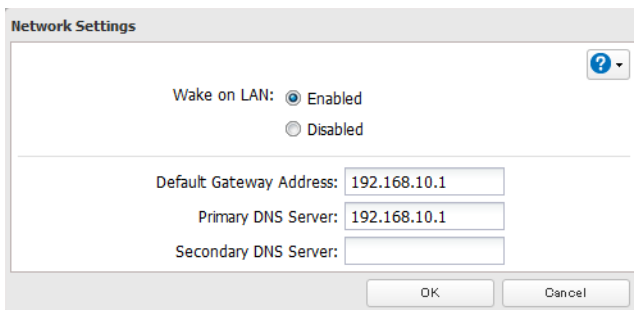

Wake-on-LAN is now enabled. As long as it is connected to power and the network, you can turn on the TeraStation remotely.

### Notes:

- After a power outage, wait 5 minutes after power is restored to send the Wake-on LAN packet to the TeraStation.
- After receiving the Wake-on-LAN packet, the TeraStation may take approximately five minutes to be ready to use.
- To use Wake-on-LAN, you'll need Wake-on-LAN software such as AMD's Magic Packet utility. The TeraStation does not include Wake-on-LAN software.
- The TeraStation does not support using Wake-on-LAN and port trunking at the same time. You may use either feature, but not both at the same time.
- On the local network, Wake-on-LAN packets may be sent to port 2304 on either of the TeraStation's LAN ports. If the TeraStation is connected to a Buffalo wireless router configured for remote access, then it may be turned on from outside the local network (from the WAN side). To use this feature, connect the router to only LAN port 1 on the TeraStation.

# UPS (Uninterruptible Power Supply)

If a UPS (sold separately) is attached, the TeraStation can be automatically shut down for protecting data in the event of a power outage.

- 1 Plug the power cable of the UPS to a wall socket.
- 2 Connect the AC cable of the TeraStation to the UPS.
- 3 Connect the UPS and TeraStation using a USB cable or serial cable.
- 4 Turn on the UPS, then the TeraStation.
- 5 In Settings, click *Management*.

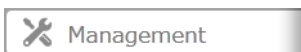

- 6 Click  to the right of "UPS Sync".



- 7 Click *Edit*.

- 8 Configure the desired settings, then *OK*.

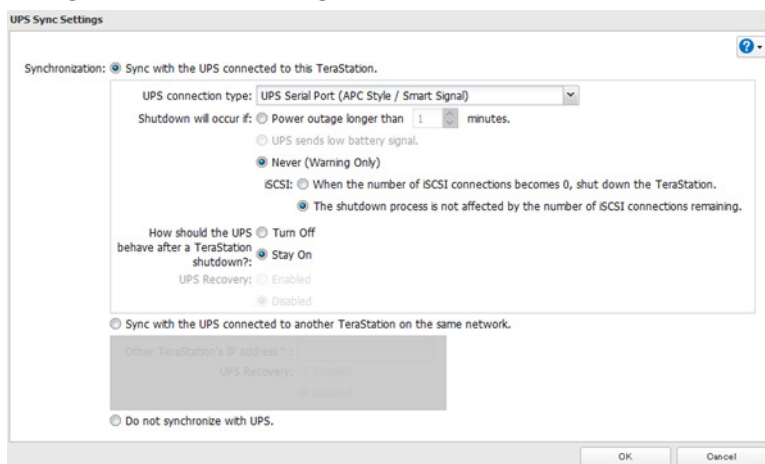

## Notes:

- If the TeraStation is connected directly to a UPS, select "Sync with the UPS connected to this TeraStation". If a different TeraStation is connected to the UPS, select "Sync with the UPS connected to another TeraStation on the same network." After making this selection, enter the IP address of the TeraStation that will be the sync source in "Other TeraStation's IP address".
- When the TeraStation is rebooted after an automatic shut down due to a power outage or other power supply problem, verify that the power supply has been restored. If the TeraStation is turned on while it is still running on the UPS and without the power supply restored, automatic shutdown is not performed, even after the specified time has elapsed.
- If the power supply from the UPS to the TeraStation is stopped and restarted when UPS recovery is enabled, the TeraStation is automatically restarted.

## Port Trunking

Two Ethernet cables can be used to establish two separate communication routes providing LAN port redundancy and improving communication reliability. The use of two Ethernet cables enables access to the TeraStation even if one of the cables is disconnected.

The port trunking modes that can be set in the TeraStation are shown below.

Trunking Mode	Characteristics
Disabled	Port trunking is not used.
Round-robin*	A round-robin policy is set for providing fault tolerance and load balancing.
Active-backup	An active-backup policy is set for providing fault tolerance
XOR*	An XOR (exclusive-or) policy is set for providing fault tolerance and load balancing.
Broadcast	A broadcast policy is set for providing fault tolerance.
Dynamic link aggregation**	An IEEE 802.3ad dynamic link aggregation policy is set.
TLB	An adaptive transmit load balancing (TLB) policy is set for providing fault tolerance and load balancing.

\*A separate intelligent switch that supports EtherChannel or other port trunking is required. Configure two LAN ports on the switch for port trunking first.

\*\*A separate intelligent switch that supports IEEE 802.3ad is required. Configure LACP in the switch first.

## Port Trunking

If the TeraStation is being used as an iSCSI hard drive and you need to change the settings, navigate to *Drives - iSCSI* in Settings and set the icon to .

**1** Use an Ethernet cable to connect the hub LAN port and TeraStation LAN port 1.

### Notes:

- Do not connect the second Ethernet cable to the TeraStation yet.
- If using an intelligent switch, connect to a LAN port that was set for port trunking.

**2** In Settings, click *Network*.

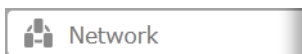

**3** Click  to the right of "Port Trunking".

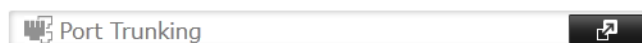

**4** Choose a port trunking link.

**5** Select the port that will be used, select the port trunking mode, and click *Change port trunking*.



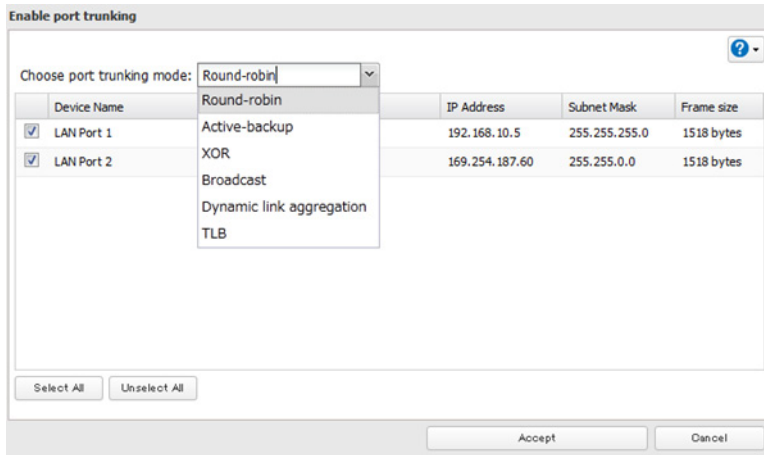

- 6** Connect the hub LAN port and TeraStation LAN port 2 using the second LAN cable. If you are using an intelligent switch, connect to a LAN port that was set for port trunking earlier.
- 7** Reboot the TeraStation before use.

## Connecting a Printer

You can connect a printer to the USB port on the TeraStation.

### Notes:

- Only one USB printer can be connected to the TeraStation.
- Bidirectional communication is not supported i.e., remaining ink quantities and other printer status information is not supported.
- If a multifunctional printer is connected, only the printer function can be used. Other functions such as scanning will not be available.
- The print server does not support Mac OS.

## Setting Up a Printer with Windows 8, Windows 7, or Windows Vista

- 1** In Settings, click *Services*.



- 2** Move the Print Server switch to the  position to enable Print Server.



- 3** Refer to the manual supplied with the printer and install the printer drivers.
- 4** Click *Start - Network*.  
For Windows 8, click the *Network* in *File Explorer*.

- 5 Double-click the TeraStation server name.
- 6 Double-click the icon of the connected printer (shared name is displayed).

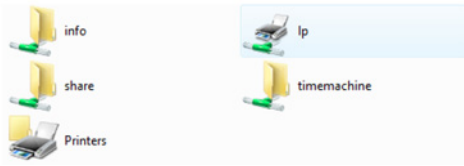

- 7 Select your printer, then click OK.



- 8 Register the printer.

## Setting Up a Printer with Windows XP

---

- 1 In Settings, click *Services*.



- 2 Move the Print Server switch to the  position to enable Print Server.



- 3 Refer to the manual supplied with the printer.

- 4 Click *Start - Control Panel*.

- 5 Click *Network and Internet Connections*.

- 6 Click *My Network Places - View workgroup computers - (Name of the TeraStation Server name)*.

- 7 Double-click your printer icon.

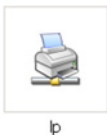

- 8 When “The server for the printer does not have the correct printer driver installed. If you want to search for the proper driver, Click *OK*.” displays, click *OK*.
- 9 Register the printer.

## TeraSearch

TeraSearch lets you search for character strings contained in files (text files, Word files, etc.) stored on the TeraStation. Follow the steps below to enable it.

- 1 Open *Folder Setup*.



- 2 Click the shared folder to be indexed.
- 3 Click *Edit*.
- 4 Check “Include this folder in the search index”, then click *OK*.

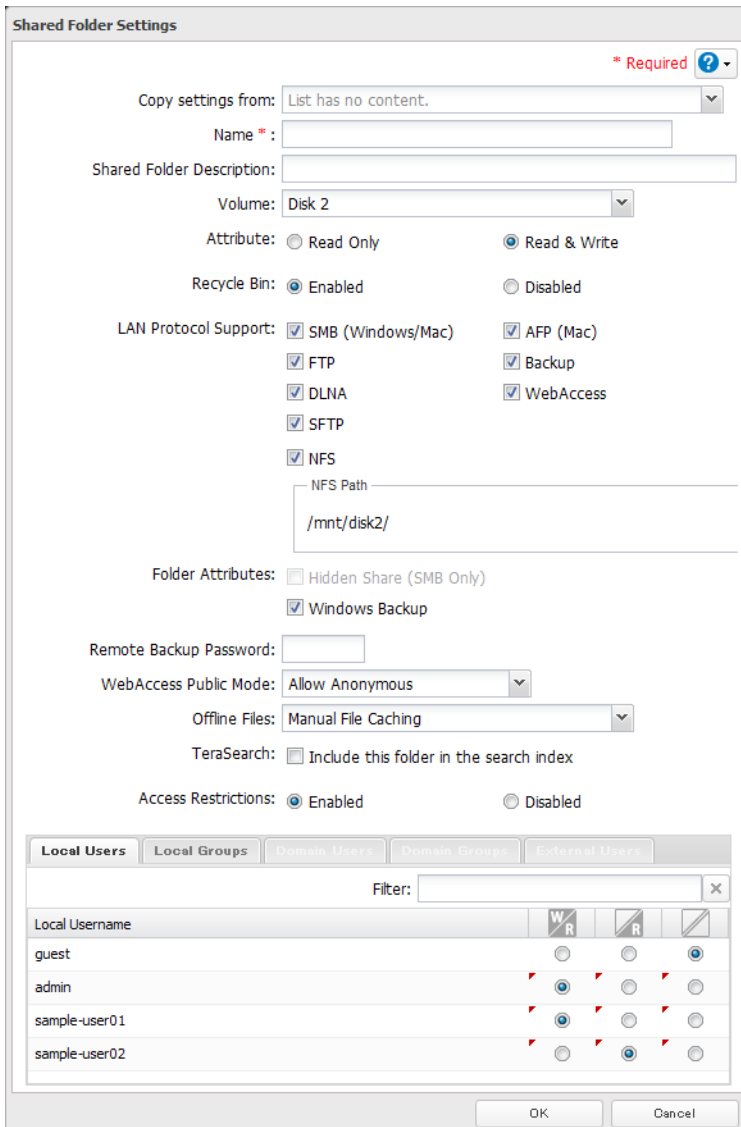

**5** Click *OK*.

**6** Click *Close*.

**7** Click *Applications*.

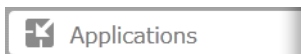

**8** Move the TeraSearch switch to the  position to enable TeraSearch.

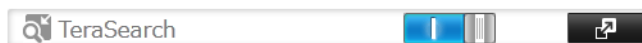

**9** Click the  icon to the right of "TeraSearch".

**10** Click *Refresh Index*

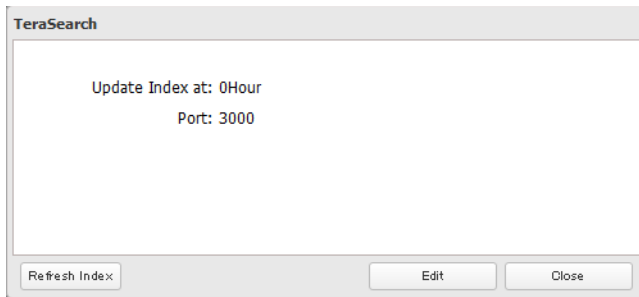

**11** Click *Edit*.

**12** Enter the port number that you want to use and the time that the index will be updated, then click *OK*.

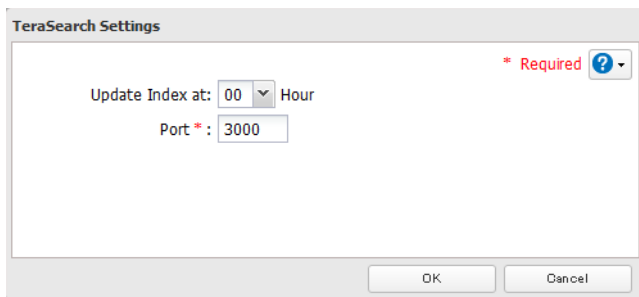

**13** Open the following URL in your browser.

[http://\(IP address of your TeraStation\):3000/](http://(IP address of your TeraStation):3000/)

**Note:** You can identify your IP address from NAS Navigator2.

**14** Enter your TeraStation's username and password, then click *Login*.

**15** Enter a keyword in the "Search" field. Click Enhanced Search to enable searches by specifying the filename, owner, date updated, and file size.

**16** Click *Search*.

The search results are displayed. Click the filename in the results to open the file.

## Offline Files

Offline files included with many versions of Windows, can be used to access files in the TeraStation, mimicking the computer's behavior even if it is disconnected from the network. When connected to the network again, the updated files are written and synchronized. Follow the procedure below to use offline files.

**1** In Settings, click the  icon to the right of "Folder Setup".

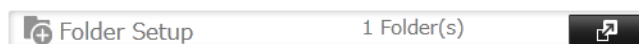

**2** Click the shared folder for offline files.

**3** Click *Edit*.

- 4 Choose “Manual File Caching”, “Automatic File Caching”, or “Automatic Program and File Caching”, then click *OK*.

Shared Folder Settings

\* Required ?

Copy settings from: List has no content.

Name \* :

Shared Folder Description:

Volume: Disk 2

Attribute:  Read Only  Read & Write

Recycle Bin:  Enabled  Disabled

LAN Protocol Support:  SMB (Windows/Mac)  AFP (Mac)  
 FTP  Backup  
 DLNA  WebAccess  
 SFTP  
 NFS

NFS Path  
/mnt/disk2/

Folder Attributes:  Hidden Share (SMB Only)  
 Windows Backup

Remote Backup Password:

WebAccess Public Mode: Allow Anonymous

Offline Files: Manual File Caching

TeraSearch:  Include this folder in the search index

Access Restrictions:  Enabled  Disabled

Local Username	W	R	W	R	W	R
guest	<input type="radio"/>	<input type="radio"/>	<input type="radio"/>	<input type="radio"/>	<input checked="" type="radio"/>	<input type="radio"/>
admin	<input checked="" type="radio"/>	<input type="radio"/>	<input checked="" type="radio"/>	<input type="radio"/>	<input type="radio"/>	<input type="radio"/>
sample-user01	<input checked="" type="radio"/>	<input type="radio"/>	<input checked="" type="radio"/>	<input type="radio"/>	<input type="radio"/>	<input type="radio"/>
sample-user02	<input type="radio"/>	<input checked="" type="radio"/>	<input type="radio"/>	<input checked="" type="radio"/>	<input type="radio"/>	<input type="radio"/>

OK Cancel

**Notes:**

**Manual File Caching** - User selects files that are cached.

**Automatic File Caching** - Opened files can be cached locally for offline use. Previous versions of files that are not synchronized are automatically replaced by the latest versions.

**Automatic Program and File Caching** - Opened files can be cached locally for usage offline. Previous versions of files and applications executed from the network that are not synchronized are automatically replaced by the latest version of the files and applications.

- 5 Click *OK*.
- 6 Click *Close*.
- 7 In Windows, navigate to *Folder options*. (Windows 8 and Windows 7 users should skip to step 9).
- 8 Check “Enable Offline Files”, then click *OK*.

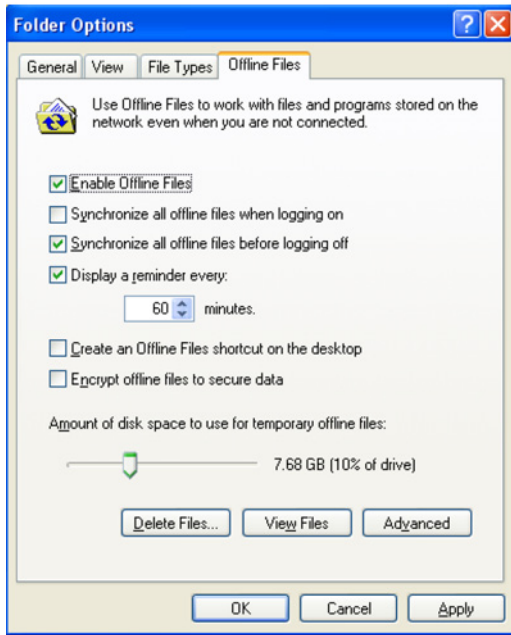

**Note:** Offline files cannot be enabled if “Use Fast User Switching” is enabled. To change the setting, open “User Accounts” in Control Panel and select “Change the way users log on or off”.

- 9 Right-click the icon of the shared folder on the TeraStation for which you have set the offline feature, then click *Make Available Offline*.

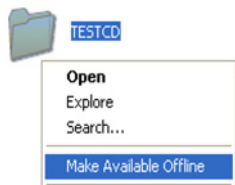

- 10 When the Offline file wizard opens, follow the instructions on the screen. For more information, refer to the Windows help.

- 11 When the offline settings and sync settings are completed using the wizard, the files and folders set appear as shown:



- 12 If the network is disconnected after synchronization is completed, the offline file function can be used. Offline files can be accessed by the original Universal Naming Convention (UNC) where the data was saved.

**Notes:**

If offline files can be used, an icon appears in the system tray.

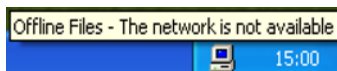

**Editing Offline Files** - Offline files can be edited and deleted in the same way as normal files. Differences that arise from the original data on the network due to editing or deleting of the file are resolved by resynchronization after the network is reconnected.

**Synchronizing Offline Files** - The offline file is automatically synchronized based on preset conditions, such as

after reconnection with the network, logging on, logging off, etc.

**Version Conflicts** - A file conflict occurs if different changes were made simultaneously to the offline file and original data on the network. The screen below is displayed when a file conflict is detected. Resolve the conflict by following the instructions on the screen.

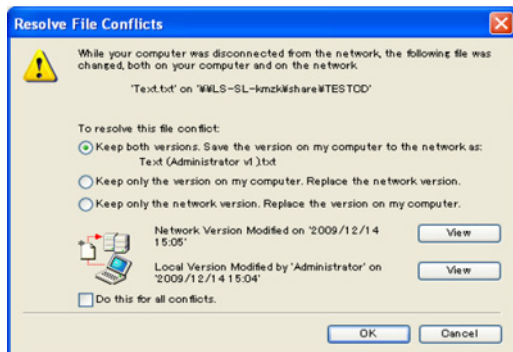

## DFS

DFS (Distributed File System) is a set of client and server services that allows Windows users to organize many distributed SMB file shares into a distributed file system. Follow the steps below to enable DFS on the TeraStation.

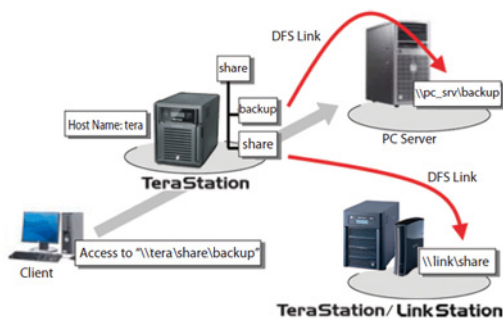

- 1 In Settings, click  to the right of "DFS".



- 2 Click *Edit*.

- 3 Enable or disable "Set DFS Link to DFS Root".

**Note:** If enabled, a DFS link target shared folder is created under the DFS root. If disabled, up to eight DFS link target



shared folders can be created under the DFS root.

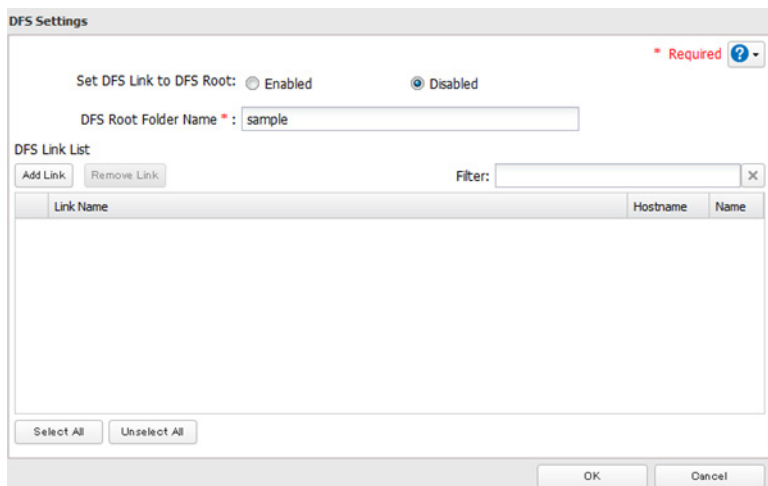

- 4 Enter *DFS Root Folder Name*.
- 5 Click *Add Link*.
- 6 Enter the link name, hostname, and shared folder name, then click *OK*.

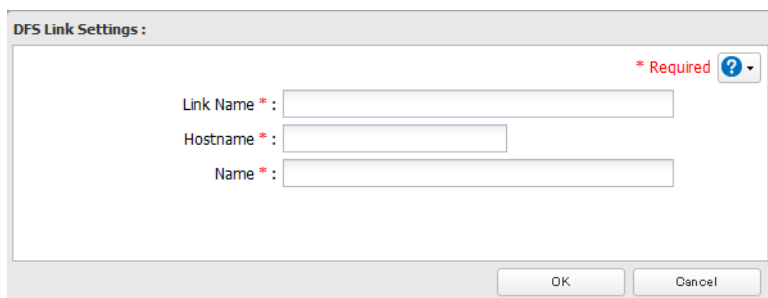

**Notes:**

- TeraStations, LinkStations, and SMB-compatible Windows computers can be specified as DFS link targets (Mac OS and Linux are not supported.)
- If “DFS link to DFS root” is disabled, you may create up to 8 hostnames and DFS links.

- 7 Click *OK*.
- 8 Move the DFS switch to  position to enable DFS.

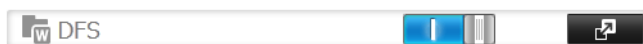

## Accessing from a NFS Client

**Note:** (US purchasers only) Buffalo’s customer support will help configure the NFS settings on your TeraStation, and will support VMware and Windows clients but will not provide support for configuring your Linux or other UNIX clients. There are many types of UNIX and the procedures for configuring NFS with them will vary considerably. For help configuring your Netware, Linux, or other UNIX clients for NFS support please consult each client’s own

documentation and support.

**1** Open *Folder Setup*.

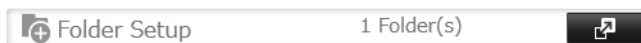

**2** Choose the shared folder that will be accessible to the NFS client.

**3** Click *Edit*.

**4** Under *LAN Protocol Support*, enable "NFS". Click *OK*.  
Note the NFS path. It will be used later for accessing data from an NFS client.

**5** Click *Close*.

**6** Click the slide to enable NFS.

**7** Click the icon to the right of "NFS"

**8** Click *Client Settings*.

**9** Click *Add Client*.

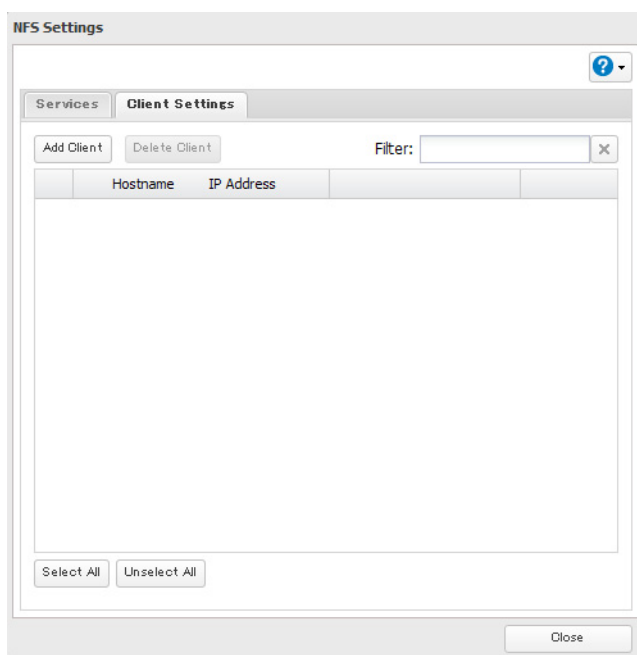

**10** Enter the IP address and hostname of the NFS client, then click *OK*.

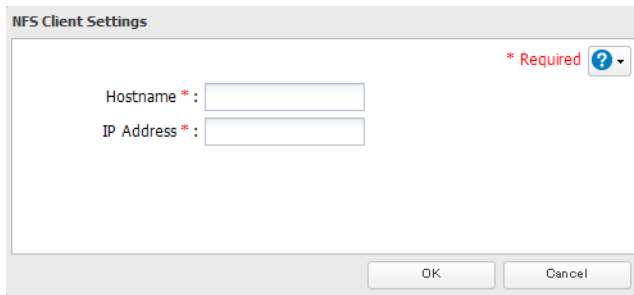

To delete the client, check the hostname and click *Delete Client*.

**11** Click *Close*.

**12** Enter the mount command to access the shared folder from the NFS client.

The examples below assume that IP address of your TeraStation is 192.168.11.10 and you want to mount “/mnt/array1/share” (NFS path) as “/mnt/nas” or drive character “z” (mount point).

**For Linux:**

```
mount -t nfs 192.168.11.10:/mnt/array1/share /mnt/nas
```

**For Windows Service for Unix 3.5:**

```
mount 192.168.11.10:/mnt/array1/share z:
```

**For Solaris 10:**

```
mount -F nfs 192.168.11.10:/mnt/array1/share /mnt/nas
```

#### Notes:

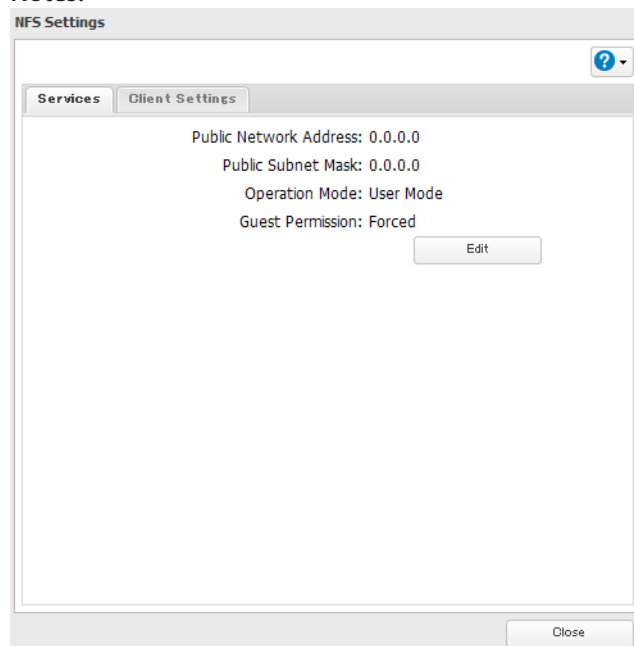

- To configure access restrictions by IP address, click *Services - Edit*, then enter the desired settings.
- To use shared folders set for NFS as drives on VMware ESX/ESXi, change the operation mode from “User Mode” (default setting) to “Kernel Mode” on the screen navigating to *Services - Edit*.
- If you configure “Guest Permission” to “Forced” on the screen navigating to *Services - Edit*, User ID and Group ID should be 99 when the data is written from NFS clients; this is recommended for SMB or other protocols as well. Use “Ignored” if the TeraStation only enables NFS connection.

## Encrypting Settings Data

---

All communication to Settings can use SSL encryption if you access settings through https://.

## Encrypting FTP Transfer Data

---

You can encrypt passwords and files using SSL/TLS for secure FTP communication. First, in the shared folders settings, select *FTP* under *LAN Protocol Support* In Settings. Enable SSL security in the setup screen for your FTP client. The procedure depends on the FTP client software.

## SSL Keys

---

SSL keys are used during setup screen operations and FTP communication. SSL (Secure Socket Layer) is a type of encryption system called public key encryption. Generally, SSL is managed by the two files below.

### server.crt (SSL Certificates)

In this system, the TeraStation sends this file to the computer, and the computer uses this key to perform encryption. The TeraStation receives the encrypted data and uses server.key (private key) to decrypt the data.

In SSL, this key contains the server certificate, and depending on your computer environment, a check may be performed to determine the trustworthiness of the certificate. The server certificate included in the TeraStation in the default settings was created by Buffalo Technology, and in some cases the message "There is a problem with this website's security certificate" may be displayed in your browser or other software. Disregard this message and continue.

### server.key (SSL Key)

This file is used as a pair with server.crt (server certificate). This is required for decrypting the data that was encrypted by the server certificate, and this is normally not revealed.

## Updating SSL Key

To update a server certificate and a private key for SSL, follow this procedure.

- 1 Click *Management* -  to the right of "SSL".
- 2 Register "server.key" for "Secret Key" and "server.crt" for "Server Certificate (.crt)", then click Import.

### Notes:

Place the SSL key files (server.key, server.crt) directly below the C root drive. The SSL key may not be able to be updated if it is placed in folders or paths that contain multi-byte characters.

Use the provided password for the SSL key.

If Settings cannot be displayed after updating, initialize the TeraStation settings.  
Updating the firmware initializes an SSL key.  
This completes the updating of the SSL key.

## Web Server

The TeraStation can be used as a web server. In addition to HTML files, images, and JavaScript, the TeraStation also allows installation of Perl script and PHP script files. The web server uses version 1.4.23 of lighttpd, version 5.8.8 of Perl, and version 5.2.10 of PHP.

- 1 In Settings, click *Services*.



- 2 Move the Web Server switch to the  position to enable the web server.



- 3 Click  to the right of "Web Server".

- 4 Click *Edit*.

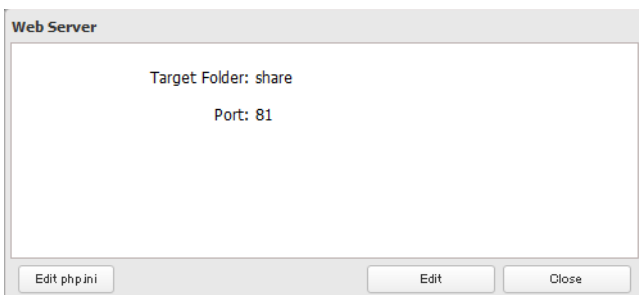

**Note:** The settings of the PHP language interpreter can be changed from "Edit php.ini".

- 5 Click *Browse*.

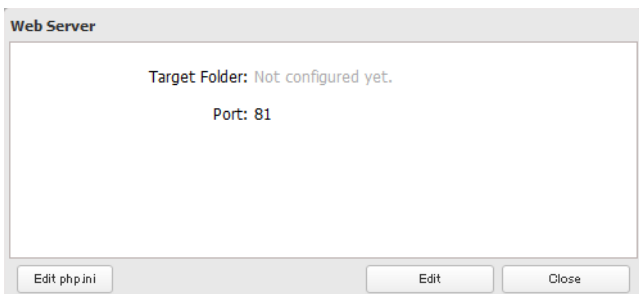

- 6 Choose a shared folder for the web server, then click *OK*.

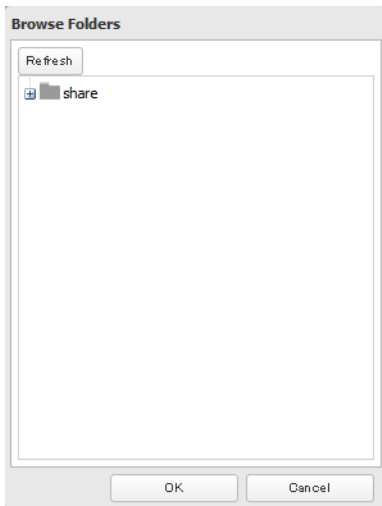

- 7 Choose an external port, then click *OK*.

## MySQL Server

The TeraStation can be used as a MySQL server. A MySQL database may be installed and linked with the web server. The TeraStation uses version 5.0.70 of MySQL server and version 3.2.2 of PhpMyAdmin.

- 1 In Settings, click *Services*



- 2 Move the MySQL Server switch to the  position to enable the MySQL server.

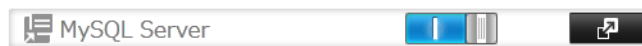

- 3 Click  to the right of "MySQL Server".

- 4 Click *Edit*.

- 5 Click *Browse*.

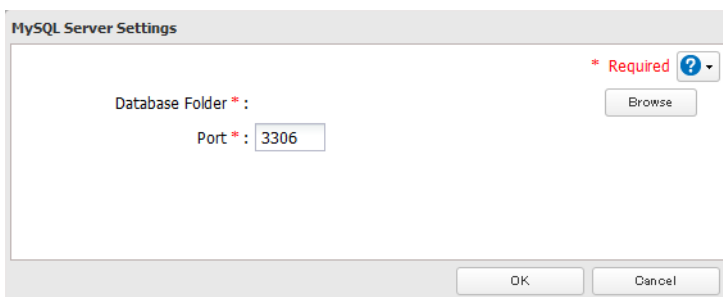

- 6 Choose a shared folder for the MySQL server, then click *OK*.

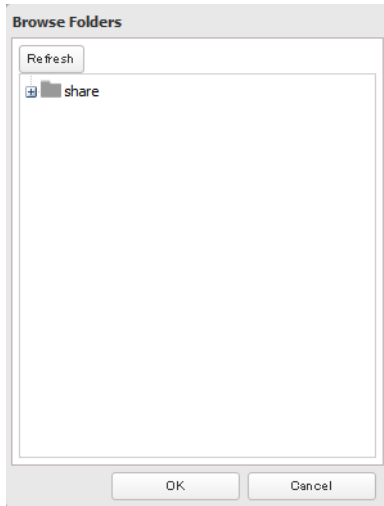

- 7 Choose an external port, then click *OK*.

## SNMP

If SNMP is enabled, you can browse your TeraStation from SNMP-compatible network management software. The specific MIB (management information base) file for Buffalo Technology is available from the Buffalo Technology website ([buffalotech.com](http://buffalotech.com)).

- 1 In Settings, click *Network*.

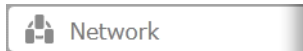

- 2 Move the SNMP switch to the  position to enable SNMP.



- 3 Click  to the right of "SNMP".

- 4 Click *Edit*.

- 5 Configure the desired settings, then click *OK*.

## Saving and Applying Settings

The TeraStation's settings can be saved to a USB memory device and restored to another TeraStation. Use this function to back up and copy settings to a new TeraStation.



Make a note of the hard drive configuration (number of hard drives, RAID, LVM, etc.) of the TeraStation where the

settings were saved. Make sure that any TeraStation that you apply these settings to has exactly the same hard drive configuration before you apply the settings. If the drive configuration is different, you may get unexpected results.

Following settings cannot be saved or recovered:

Category	Settings
File sharing	
USB drive and memory cartridge shared folder information	
All settings in "Drives"	All settings in "RAID" - "Options" - "RAID Array Settings"
	All settings in "LVM"
	All settings in "iSCSI"
	USB drive and memory cartridge information
Network	All settings in "IP address"
	All settings in "port trunking"
Backup	All settings in "Failover"
Management	All settings in "Name"
	All settings in "UPS Sync"
	All settings in "SSL"
	Display language in Settings

## Saving Settings

- 1 In Settings, click *Management*

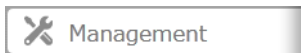

- 2 Click  to the right of "Restore/Erase".



- 3 Insert a USB memory device into a USB port on the TeraStation.

### Notes:

- If your TeraStation model has a USB 3.0 port, use one of the USB 2.0 ports instead.
- Use a USB memory device with at least 1 GB of space.
- Any data on the USB memory device will be deleted.

- 4 From "Target USB drive", select the USB memory device that is connected to the USB 2.0 port of the TeraStation.

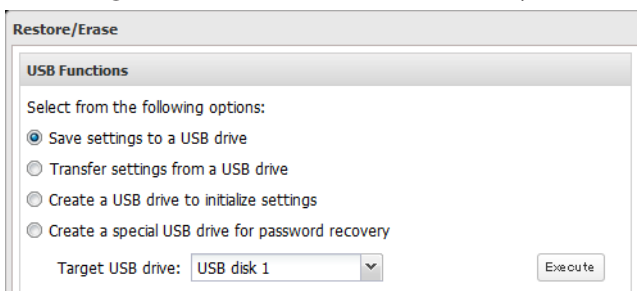

- 5 Select "Save settings to a USB drive". Or, to create a USB memory device that resets the TeraStation administrator



password to the default password, select “Create a special USB drive for password recovery”. Click *Execute*.

## Troubleshooting:

If the settings are not saved to the USB memory device successfully, you may receive the error message “The specified operation cannot be executed”. Verify:

- The device is connected to a USB 2.0 port, not a USB 3.0 port.
- The device has a capacity of 1 GB or larger.
- The device is not write-protected.

## Applying Settings

---

The saved settings can be applied to a different TeraStation.

**1** Connect the USB memory device with the saved settings to a USB 2.0 port of the TeraStation (not a USB 3.0 port).

**2** In Settings, click *Management*.

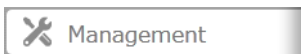

**3** Click  to the right of “Restore/Erase”.



**4** From “Target USB drive”, select the USB memory device that is connected to the USB 2.0 port of the TeraStation.

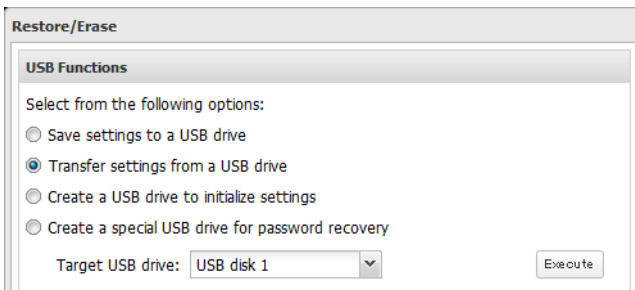

**5** Select “Transfer settings from a USB drive”, then click *Execute*.

## Restoring Factory Defaults

## Initializing from Settings

---

To initialize the TeraStation to its factory defaults from Settings, follow this procedure.

**1** In Settings, click *Management*.



- 2 Click  to the right of “Restore/Erase”.



- 3 Click *Initialize TeraStation*.

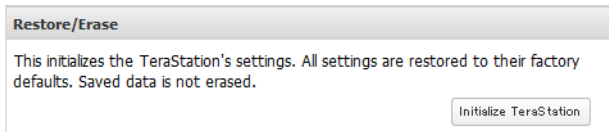

- 4 The “Confirm Operation” screen will open. Enter the displayed number, then click *OK*.

- 5 The TeraStation will be restored to its factory default settings.

## Creating an Initialization Drive

---

A system initialization drive will restore the settings on your TeraStation to their factory defaults. You can initialize them without logging in to Settings. Follow the steps below to create a system initialization drive.

### Notes:

Normally, making and using the system initialization drive will not affect data. However, always back up your data regularly!

This USB drive can use to recover the system if your TeraStation doesn't boot at all. In this case, if the data partition is damaged, then all your data will be deleted by the recovery process.

- 1 In Settings, navigate to *Management-Restore/Erase-USB Options*.
- 2 Select *Create a USB drive for initializing settings*.
- 3 Insert a 1 GB or larger USB flash drive into a USB port on the TeraStation.  
**Note:** All data on the USB flash drive will be erased!
- 4 Select the USB memory device from “Target USB drive”, then click *Execute*.
- 5 Enter the 4 digit confirmation number and click *OK*. The TeraStation will create the initialization drive. This will take about a minute.
- 6 When the “finished” dialog opens, the USB initialization drive is ready to use. Dismount the USB drive before unplugging it. See “Dismounting Drives” in Chapter 4 for the instructions on dismounting drives.

## Initializing with the USB Drive

---

To initialize the settings on your TeraStation with the USB drive as created in above, follow the procedure below.

- 1 Create a USB “initialization drive” as described above.
- 2 Insert the USB drive into a USB 2.0 port (not a USB 3.0 port) on the TeraStation.
- 3 Set the boot mode switch to “USB”.

- 4** Press the power button to turn on the TeraStation.
- 5** When the message “Recovery I41 PushFuncToStart” appears on the LCD panel, press the function button.
- 6** It will take several minutes for initializing the settings. The TeraStation will shut down when it’s finished.
- 7** After shutdown, “Recovery I39 Change Boot” is displayed.
- 8** Set the boot mode switch to “HDD” position.
- 9** Press the power button to start the TeraStation.

## Resetting the Administrator Password

### Creating a Password Reset Drive

---

A password initialization drive can reset the administrator password to its default value (“password”). This could be very useful if you forget your admin password.

- 1** In Settings, navigate to *Management - Restore/Erse - USB Options*.
- 2** Connect a 1 GB or larger USB memory device (not included) to a USB 2.0 port on the TeraStation.
- 3** Select *Create a USB drive for resetting the admin password*.  
**Note:** All data on the USB flash drive will be erased!
- 4** Select the USB memory device from “Target USB drive” list, then click *Execute*.
- 5** Enter the 4 digit confirmation number and click *OK*. The TeraStation will create the password reset drive. This will take about a minute.
- 6** When the “finished” dialog opens, the password reset drive is ready to use. Dismount the USB drive before unplugging it. See “Dismounting Drives” in Chapter 4 for the instructions on dismounting drives.

### Resetting with the USB Drive

---

To reset your admin password, follow the procedure below.

- 1** Create a USB “password initialization” drive as described above.
- 2** Insert the USB drive into a USB 2.0 port (not a USB 3.0 port) on the TeraStation.
- 3** Set the boot mode switch to “USB”.
- 4** Press the power button to turn on the TeraStation.
- 5** When the message “Recovery I41 PushFuncToStart” appears on the LCD panel, press the function button.

- 6 The password will be reset to its factory default. The TeraStation will shut down when it's finished.
- 7 After shutdown, "Recovery I39 Change Boot" is displayed.
- 8 Set the boot mode switch to "HDD" position.
- 9 Press the power button to start the TeraStation.

## Logs

Follow this procedure to check the TeraStation's logs.

- 1 In Settings, click *Management*.

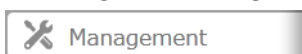

- 2 Click  to the right of "Logs".



- 3 Select a log to view.

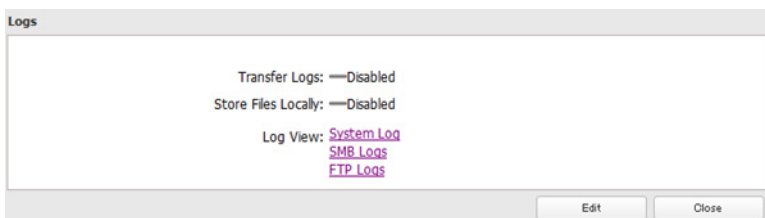

The file operation log stores file operations performed on the internal hard drives. File operations on USB drives are not logged.

### To transfer logs

- 1 Click *Edit*.
- 2 Enable "Syslog Transfer".
- 3 Enter the IP address of the syslog server where you want to transfer the logs to.
- 4 Select the type of log that you want to transfer from "Logs To Transfer".
- 5 Click *OK*.

FTP logs cannot be written to a syslog server.

Logs are in UTF-8 format. Your Syslog server must support UTF-8 encoding.

## To create a link to the logs in the shared folder

- 1 Click *Edit*.
- 2 Enable “Share the link to logs”.
- 3 Select the shared folder where the link will be created in “Target Shared Folder”.
- 4 Click *OK*.

Under the selected shared folder, a folder named “system\_log” will now contain the logs.

## Updating the Firmware

If a new firmware is available, a message is displayed when the TeraStation boots. You can update the firmware by either of the following ways:

### To update from Settings:

- 1 In Settings, click *Management*.

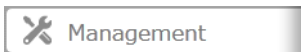

- 2 Choose *Update*.



- 3 Click *Install Update*.

### To update from the Buffalo Technology website

From the <http://www.buffalotech.com> website:

- 1 Click *Support and Downloads*.
- 2 Click *Products*.
- 3 Click *Network Storage (NAS)*.
- 4 Click your TeraStation model.
- 5 Click *Downloads*.
- 6 Click the downloadable file for your OS.

## Name, Date, Time, and Language

Configure the TeraStation's hostname, date, time, and language as follows.

**Note:** If the TeraStation is being used as an iSCSI hard drive, to change the settings, navigate to *Drives - iSCSI* in Settings and set the icon to  .

- 1 In Settings, click *Management*.

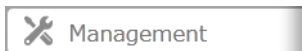

- 2 Open *Name/Time/Language*.



- 3 Click *Edit*.

- 4 Click the *Name* tab, then configure the TeraStation's name and description.

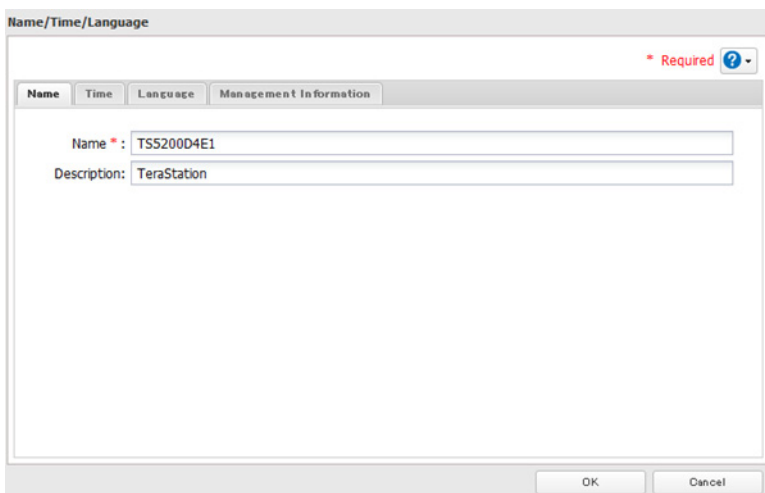

- 5 Click the *Time* tab.  
Click *Use Local Date/Time* to use your computer's time settings for the TeraStation.

By default, the TeraStation adjusts its clock automatically by using a default NTP server.

This NTP server belongs to Internet Multi Feed Inc. For more information, visit [www.jst.mfeed.ad.jp](http://www.jst.mfeed.ad.jp).

You can select a different NTP server by clicking *Name/Time/Language* on the "Management" screen. The "Name/Time/Language" screen opens.

- (1) Click *Time*.
- (2) Click *Edit*.
- (3) Uncheck "Use Default NTP Server" and enter a new NTP IP address.
- (4) Click *OK*.

If NTP is not used, enter the time and date manually. Click *Use Local Date/Time* to import the time and date from your computer.

In certain cases, the DNS server address must be set in order to access the NTP server.

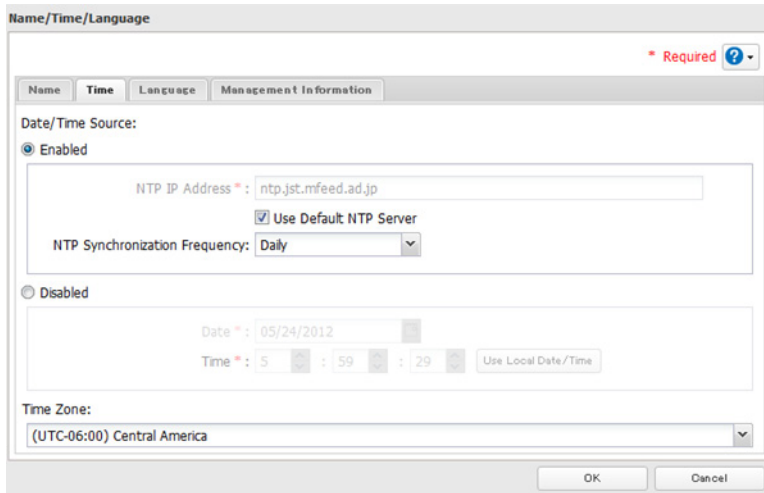

**Note:** The internal clocks of the TeraStation and other devices on your network may run at slightly different speeds. Over a long period of time your network devices may show somewhat different times, which can cause network problems. If clocks on your network vary by more than 5 minutes it may cause unexpected behavior. For best results, keep all clocks on the network set to the same time by adjusting them regularly, or use an NTP server to correct them all automatically.

- 6 Click the *Language* tab.  
Select the language to be used in the Windows client, then click *OK*.

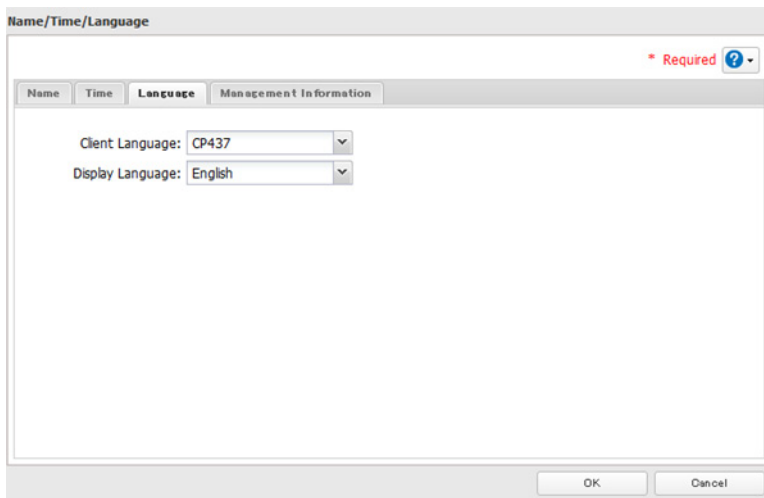

## Beep Alerts

You can set the TeraStation to beep when certain errors occur.

- 1 In Settings, click *Management*.

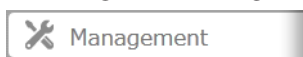

- 2 Select *Notifications*.

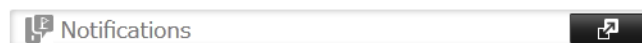

- 3 Click *Edit*.
- 4 Select the conditions to keep the alert, then click *OK*.

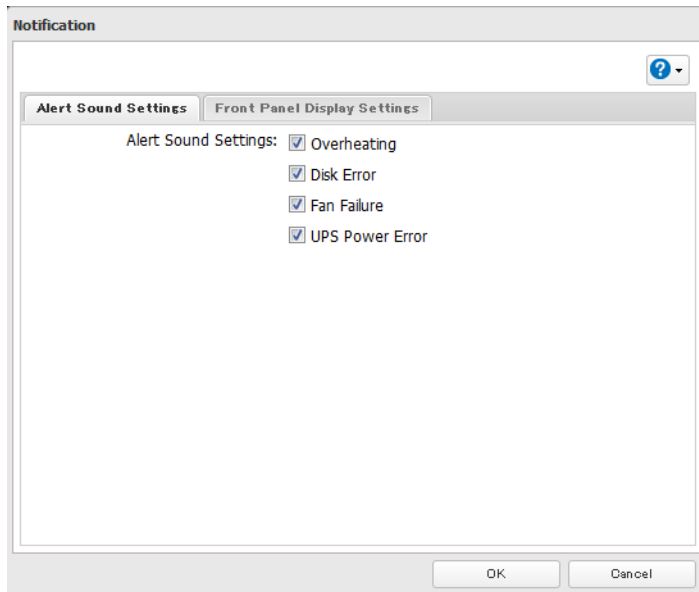

## LCD and LEDs

You may configure the LEDs and LCD on the front of the TeraStation.

- 1 In Settings, click *Management*.

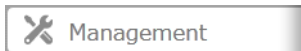

- 2 Click  to the right of "Notifications".



- 3 Click *Edit*.
- 4 Click *Front Panel Display Settings*.
- 5 Configure your settings, then click *OK*.



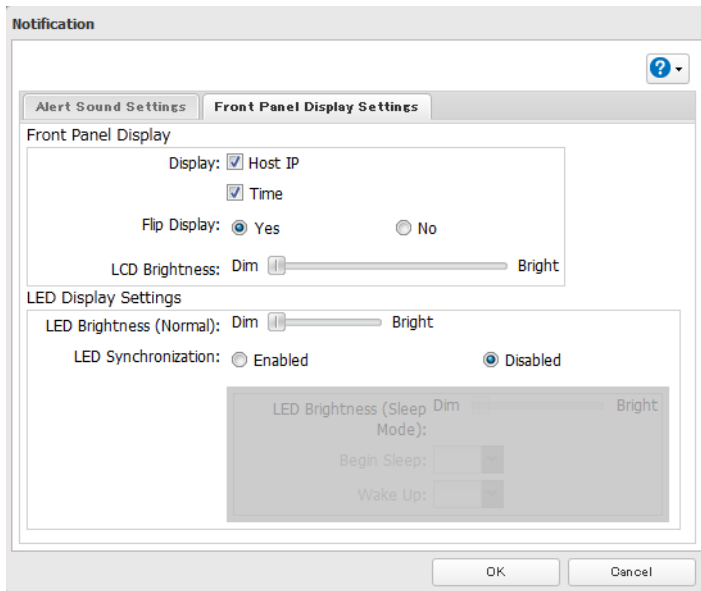



## Jumbo Frames

If your other network devices support it, you may be able to increase network performance with jumbo frames.

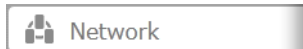
- 1 In Settings, click *Network*.



- 2 Click  to the right of "IP Address".









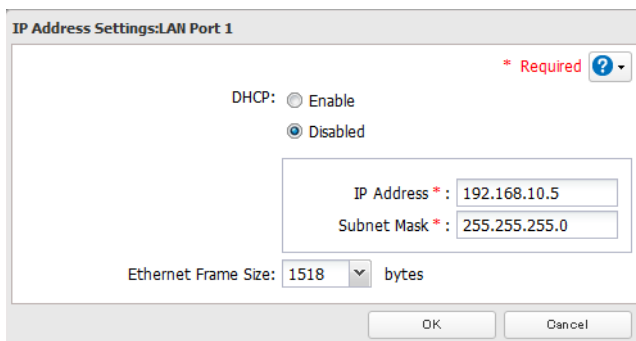





- 3 Click the LAN port where the jumbo frames will be used.

- 4 Click *Edit*.

- 5 Select "Ethernet Frame Size", then click *OK*.





Connection			Transmission	
			○	Transmit Jumbo Frame (4102/7422/9694)
Jumbo Frame (4102/7422/9694)	Jumbo Frame Supported	Jumbo Frame Supported		
			△	Transmit normally(1518)
Jumbo Frame (4102/7422/9694)	Jumbo Frame Supported	Jumbo Frame Not Supported		
			△	Transmit normally(1518)
Jumbo Frame (4102/7422/9694)	Jumbo Frame Not Supported	Jumbo Frame Not Supported		
			×	No transmission
Jumbo Frame (4102/7422/9694)	Jumbo Frame Not Supported	Jumbo Frame Supported		

## Changing the IP Address

Normally, the TeraStation's IP address is set automatically from a DHCP server on your network. If you prefer, you can set it manually. To change the TeraStation's IP address settings, your computer should be connected to the same router (subnet) as the TeraStation and should be running NAS Navigator2.

### Notes:

- NAS Navigator2 can only be used to change LAN ports that are connected to the same network subnet as the computer. To change the LAN port on a different local area side, change the IP address by navigating to *Network - IP Address* in Settings.
- If the TeraStation is being used as an iSCSI hard drive, to change the settings, navigate to *Drives - iSCSI* in Settings and set the icon to . If .

- 1 Double-click the  icon on the desktop. NAS Navigator2 will start.

**Note:** For Mac OS, click the  icon in the Dock.

- 2 Right-click on your TeraStation's icon, then choose *Properties - IP Address*.

**Note:** For Mac OS, click the TeraStation icon while holding down the control key, then click *Configure - IP Address*.

- 3 Enter the desired settings, then click *OK*.

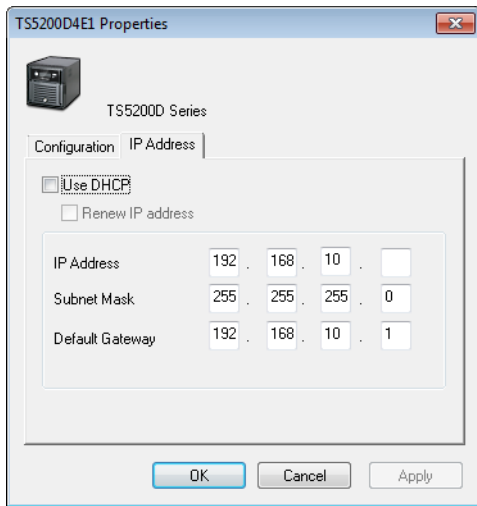

# Chapter 11 Utilities

## NAS Navigator2 for Windows

NAS Navigator2 is a utility program that makes it easy to display Settings, change the TeraStation's IP address, or check its hard drive. If you installed the TeraStation with the TeraNavigator CD, NAS Navigator2 was installed automatically.

To launch NAS Navigator2, double-click the  icon.

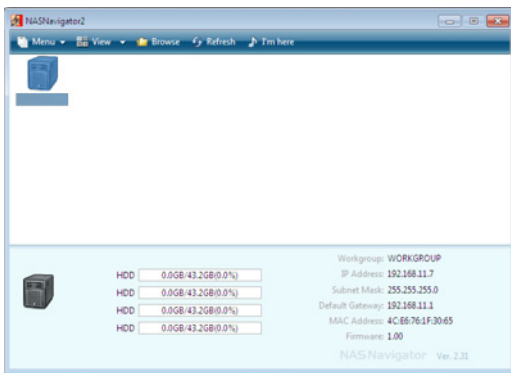

Click your TeraStation's icon to open a share on the TeraStation and display:

- Total capacity
- Capacity in use
- IP address
- Workgroup
- Subnet mask
- Default gateway
- MAC address
- Firmware version

Name	Description	
Menu	Map Share*	Assigns the TeraStation's shared folder as a network drive.
	Disconnect Share*	Unmaps the network drive.
	Map All Remote Shares to Drive Letters	Assigns all the TeraStation's shared folders as network drives.
	Create Desktop Shortcut*	Creates a shortcut to the TeraStation's shared folder (share).
	Launch NAS Navigator2 on Startup	Launches NAS Navigator2 in the system tray when Windows boots.
	Display Errors	If an error occurs, an error message will pop up from the NAS Navigator2 icon in the system tray.
	Properties*	Opens the selected TeraStation's Properties window.
	Close	Closes NAS Navigator2.

Name		Description
View	View	Icons: Displays icon. Details: Displays hostname, product name, workgroup, IP Address, subnet mask, and default gateway.
	Sort by	Selects the sort order from following to display when multiple TeraStations are found: Hostname, product name, workgroup, IP Address, subnet mask, default gateway
Browse*		Opens the TeraStation's shared folder.
Refresh		Searches for NAS devices on the network again.
Displays when you right-click a device's icon.	Browse Shares	Opens the TeraStation's shared folder.
	Settings	Opens Settings of the selected TeraStation.
	Properties	Opens the TeraStation's properties page.
	Map Share	Assigns the TeraStation's shared folder as a network drive.
	Disconnect Share	Unmaps the network drive.
	Create Shortcut	Creates a shortcut icon to the shared folder "share" on the desktop.

\*Click on the TeraStation's icon to display these options.

When NAS Navigator2 is minimized, right-click on the NAS Navigator2 icon in the system tray for the following options.

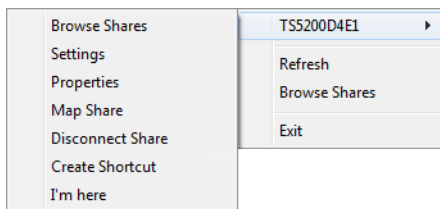

Name		Description
TeraStation Name	Browse Shares	Opens the TeraStation's share folder.
	Settings	Opens Settings of the selected TeraStation.
	Properties	Opens the TeraStation's properties page.
	Map Share	Assigns the TeraStation's shared folder as a network drive.
	Disconnect Share	Unmaps the network drive.
	Create Shortcut	Creates a shortcut icon to the TeraStation's shared folder (share) on the desktop.
Refresh		Refreshes list of NAS devices.
Browse Shares		Displays NAS Navigator2 window.
Exit		Exits NAS Navigator2.

The following tasks may be performed from the TeraStation's Properties window.

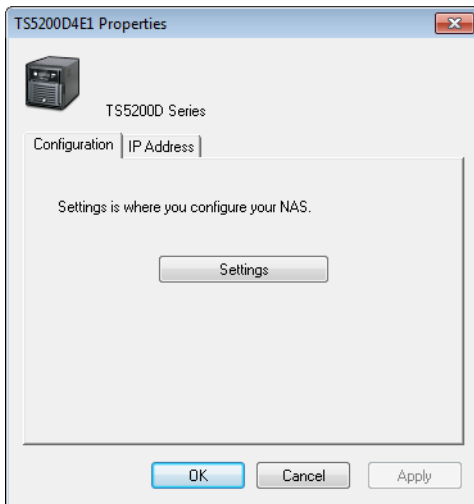

Name	Description
Configuration	Click <i>Settings</i> to open the configuration interface.
IP Address	Check <i>Use DHCP</i> to assign an IP address from the DHCP server automatically. If there is no DHCP server in the network, you cannot use this function. Check <i>Renew IP address</i> to obtain an IP address from the DHCP server. You can manually enter an IP address, subnet mask, and default gateway.

## Mount as Network Drive

You can easily map a shared folder as a network drive using NAS Navigator2.

- 1 Double-click the  icon on the desktop. NAS Navigator2 will start.
- 2 Right-click on the TeraStation's icon, then click *Map Share*.

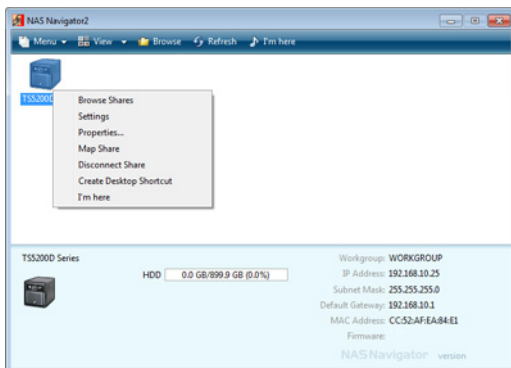

- 3 An icon for the mapped share will appear in Computer or My Computer. You can use this network drive just like any other hard drive.



## NAS Navigator2 for Mac

NAS Navigator2 is a utility program that makes it easy to display Settings, change the TeraStation's IP address, or check its hard drive.

If you installed the TeraStation with the TeraNavigator CD, NAS Navigator2 was installed automatically. To launch it, click

the  icon in the Dock.

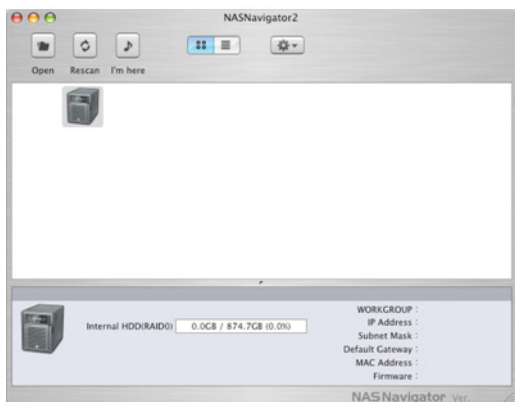

Click on a TeraStation's icon to display:

- Total capacity
- Used capacity
- Workgroup
- IP address
- Subnet mask
- Default gateway
- MAC address
- Firmware version

Double-click it to open a share on the TeraStation.

Name	Description	
Open	Opens the default shared folder for a selected TeraStation.	
Refresh	Searches for NAS devices on the network again.	
The menu is displayed when you click the TeraStation icon while holding down the control key.	Open Folder	Opens the TeraStation's Share folder.
	Settings	Opens Settings of the selected TeraStation.
	Configure	Displays the screen to open Settings or change an IP Address.
	Shutdown	This is displayed when using a LS-XL series LinkStation. The LS-XL series does not have a power switch on the case. Use this command to turn off the power.
	Label Color	Selects the color of the name displayed below the icon. The menu below is displayed when you click the TeraStation icon while holding down the control key.
	View Options	Sets the orders of icon sizes, label positions, and icons.

## Mount as Network Drive

You can map the shared folder as a network drive using NAS Navigator2 on Mac OS.

1 Click the  icon in the Dock. NAS Navigator2 will start.

2 Click the TeraStation icon while holding down the control key, then select *Open Folder*.

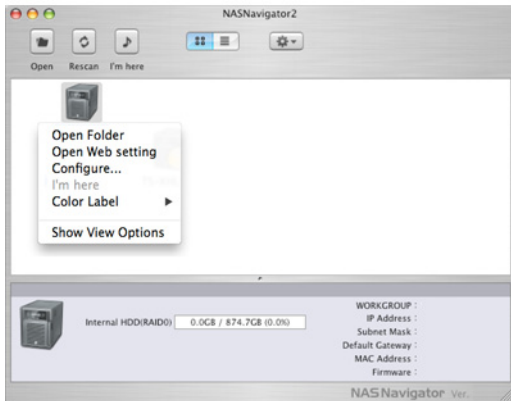

3 Select the shared folder that you want to mount, then click *OK*.



4 A drive icon  will appear on the desktop. The shared folder is now mounted as a network drive.  
**Note:** To dismount the share, drag and drop the share icon to the Trash.

## iSCSI Connection Tool

The iSCSI Connection Tool is a Windows utility that lets you use the TeraStation as an iSCSI drive. To launch it, click *Start - All Programs - BUFFALO - iSCSI Connection Tool - iSCSI Connection Tool*. For Windows 8, click the iSCSI Connection Tool.



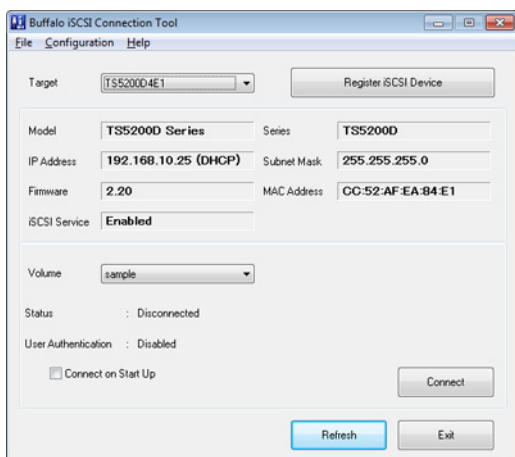

Name	Description
Target	<p>If a TeraStation is selected, clicking <i>Register iSCSI Device</i> will register all the volumes in the TeraStation to the computer for enabling connection to individual volumes.</p> <p>If a volume is already registered, click <i>Unregister iSCSI Device</i> to unregister all volumes, disconnecting them from the TeraStation.</p>
Model	Displays TeraStation's model name.
Series	Displays TeraStation's series name.
IP Address	Displays TeraStation's IP address.
Subnet Mask	Displays TeraStation's subnet mask.
Firmware	Displays TeraStation's firmware version.
MAC Address	TeraStation's MAC address.
iSCSI Service	Shows whether the iSCSI service of the TeraStation is running or stopped.
Volume	<p>Select individual volumes from a registered TeraStation.</p> <p>Select a volume and click <i>Connect</i>, then the selected volume will be recognized as a local drive in My Computer on your computer. If a volume is connected, click <i>Unregister</i> to disconnect it.</p>
Current status	<p>Displays current status of the selected volume.</p> <ul style="list-style-type: none"> <li>- Disconnected: Volume is disconnected.</li> <li>- Connected: Volume is connected.</li> <li>- Connected to another PC: Volume is connected to other computer. Displays other computer's IP address.</li> </ul>
User authorization	<ul style="list-style-type: none"> <li>- <i>Disabled</i>: No authentication.</li> <li>- <i>Enabled</i>: User authentication is needed to connect to a volume.</li> </ul>
Connect on Start Up	If selected, the computer will connect to the volume automatically at boot.
Refresh	Search for network devices on the LAN.
Exit	Exit iSCSI Connection Tool.

## Menu

Name	Description	
File	Refresh	Search for network devices on the LAN.
	Exit	Closes the iSCSI Connection Tool.

Setup	Configuration	Opens Settings for the selected TeraStation.
	Change IP address	You can change the IP address of the selected TeraStation.
	Unregister iSCSI device	If you disconnect the TeraStation without unregistering it or changing its IP address, the registration information stays in your computer and searches will take longer. For better performance, unregister disconnected TeraStations with this command.
	Set mutual CHAP secret	Set the CHAP password on the computer side.
	Persistent Volume	If checked, your computer will reconnect to the TeraStation whenever it's restarted.
	Connect volumes	Connect multiple volume at a time.
	Disconnect volumes	Displays the screen to disconnect multiple volume at a time.
	Disk management	Use Disk Management to format drives.
Help	About	Displays version information.

# Chapter 12 Appendix

## Diagrams

### TS5800D

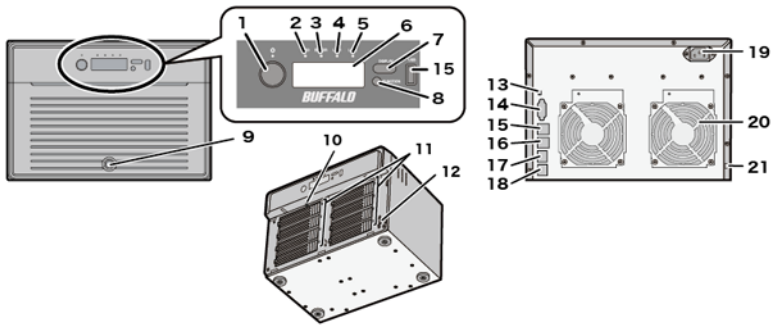

### TS5600D

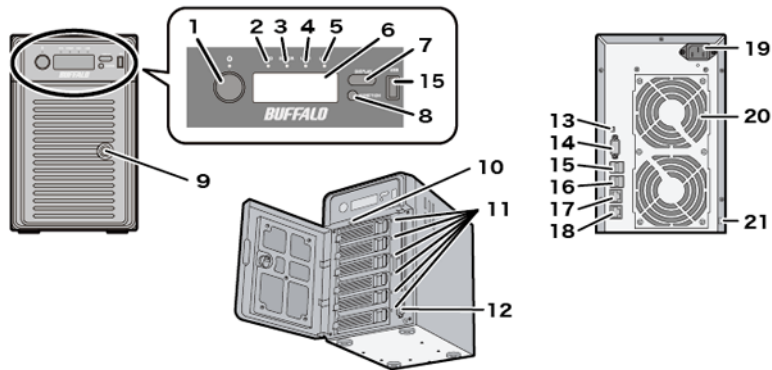

### TS5400D

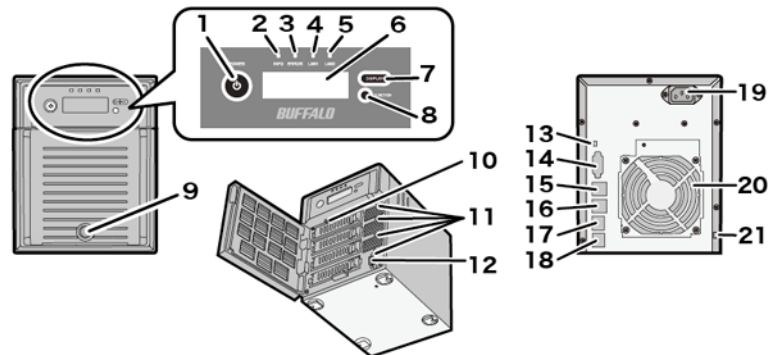

# TS5200D

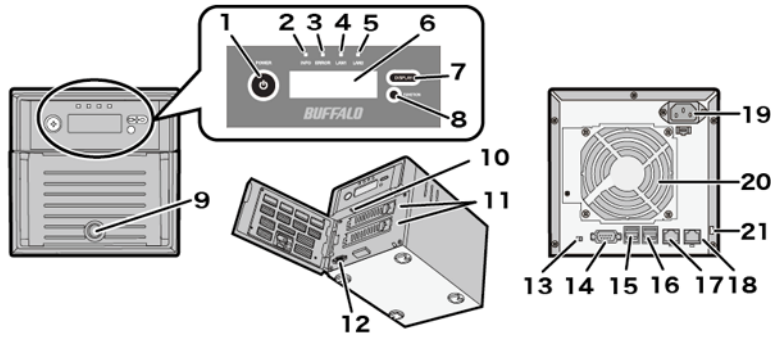

# TS5400R

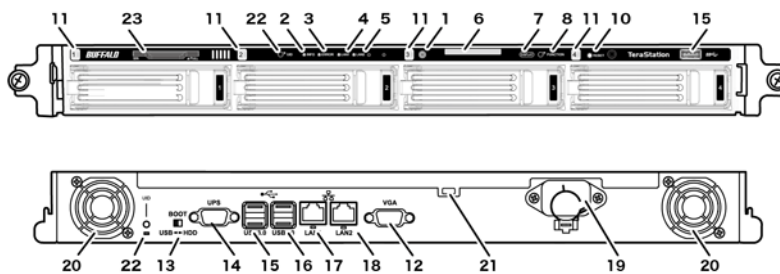

- 1 Power Button**  
To power on, connect the power cable and wait for 10 seconds, then press the power button.
- 2 Info LED**  
If there is a status message, the amber info LED is lit. Check the LCD panel.
- 3 Error LED**  
The red error LED is lit when an error occurs. Check the LCD.
- 4 LAN1 LED**  
When LAN port 1 is connected to a network, it is lit green. The light next to LAN port 1 is also lit.
- 5 LAN2 LED**  
When LAN port 2 is connected to a network, it is lit green. The light next to LAN port 2 is also lit.
- 6 LCD Panel**  
Status of the TeraStation.
- 7 Display Button**  
Switches between the display modes.  
This button stops beeping.
- 8 Function Button**  
Use this button for DirectCopy, dismounting USB devices, rebuilding RAID arrays, and configuring failover.
- 9 Drive Lock**  
Open the front panel with the key to replace hard drives or press the reset button.

## **10 Reset Button**

To shut down and reboot the TeraStation, hold down the Reset button.

## **11 Status LEDs**

LEDs are lit green when hard drives are accessed. If a drive fails, the corresponding LED glows or flashes red. It may also flash amber.

## **12 Factory Use Only**

## **13 Boot Mode Switch**

Leave the switch in the HDD position during normal operation. To recover settings, insert the recovery USB drive into a USB 2.0 port. Move the boot switch to the USB position and press the power button.

## **14 UPS Port**

Connect to a UPS.

## **15 USB 3.0 Port**

Compatible Buffalo USB 3.0 hard drives can be connected. USB hubs are not supported.

## **16 USB 2.0 Port**

Compatible Buffalo USB hard drives, USB flash drives, digital cameras, and USB UPS connection can be connected. USB hubs are not supported.

## **17 LAN Port 1**

Ethernet cable.

## **18 LAN Port 2**

Second Ethernet port for redundancy or backup. For backup, a second TeraStation may be connected directly.

## **19 Power Connector**

Use the included power cable to connect to an UPS, surge protector, or outlet.

## **20 Fan**

Do not block the fan.

## **21 Anti-Theft Security Slot**

Use this slot to secure your TeraStation with a cable lock (not included).

## **22 UID Button**

Press the UID button on the front or the back of the unit to cycle the blue LED between on and off.

## **23 Serial Number**

This sticker shows the TeraStation's serial number.

## LCD Display

The LCD display can be cycled through different modes by pressing the display button on the front of the TeraStation. Also, the items displayed can be configured at *Management - Notifications - Front Panel Display Settings* in Settings.

## Modes

LCD Message		Description	Corrective Action
LINK SPEED <b>Note:</b> When an Ethernet cable is connected to LAN Port 2, "LINK SPEED 2" is displayed.	LINK SPEED No LINK	Not connected to network.	Connect an Ethernet cable to the LAN port.
	LINK SPEED 10 Mbps HALF	Connected at 10 Mbps half duplex.	-
	LINK SPEED 10 Mbps FULL	Connected at 10 Mbps full duplex.	-
	LINK SPEED 100 Mbps HALF	Connected at 100 Mbps half duplex.	-
	LINK SPEED 100 Mbps FULL	Connected at 100 Mbps full duplex.	-
	LINK SPEED 1000 Mbps	Connected at 1000 Mbps full duplex.	-
Hostname / IP Address	TS-xx xxx 192.168.11.150	Displays the hostname and IP address. At the end of the IP address, F (fixed IP address) or D (IP address automatically acquired from a DHCP server) is displayed. <b>Note:</b> When an Ethernet cable is connected to LAN port 2, "NETWORK2" is displayed in the hostname section.	-
Calendar / Clock	DATE TIME 2012/1/1 11:11	Displays the date and time set in the TeraStation.	-

## Errors

LCD Message	Description	Corrective Action
BOOT FAIL	Hard drive not found.	Contact Buffalo technical support for assistance.
SYSTEM Error E04 Can't Load Krnl!	The firmware is corrupted.	Contact Buffalo technical support for assistance.
UPS E10 Dependent Mode	The TeraStation is running on the UPS battery due to a power outage. The system will now be shut down safely.	Check that power is being supplied to the UPS, and if there are no problems, turn on the TeraStation.
SYSTEM I10 TOO HOT!	A rise in the system temperature may have exceeded the allowable safety value.	Move the TeraStation to a cool location. Do not place objects in the area around the TeraStation.

SYSTEM Error E11 Fan Failure	An error occurred in the fan speed.	Check that no foreign objects or dust are clogging the fan. If any foreign objects or dust are found, use a pair of tweezers, air duster, or other tool to remove them. If the error is displayed again, contact Buffalo technical support for assistance.
SYSTEM Error E12 Cooling Failure	A rise in the system temperature may have exceeded the allowable safety value.	Do not place objects in the area around the TeraStation. Also, move the TeraStation to a cool location.
RAID Arrayx E14 Can't Mount	RAID array X cannot be mounted.	Run the RAID array disk check in Settings.
HDx Error E16 HDx Not Found	Unable to find hard drive X.	Hard drive X may be disconnected or may have failed. After shutting down, reinstall the hard drive.
HDx Error E22 HDx Can't Mount	Mounting of hard drive X failed.	Format the hard drive. After formatting, if the error still appears after rebooting, replace the hard drive. If the error is displayed again, contact Buffalo technical support for assistance.
FailOver E27 LostBackupTarget	Unable to find the backup TeraStation.	In the main TeraStation's settings, navigate to <i>Backup - Failover</i> to reconfigure the backup TeraStation for failover.
HDx Broken E30 Replace the DISK	An error occurred, so hard drive X was removed from the RAID array.	Replace hard drive X.

## Status

After you change settings or format a hard drive, the current status is displayed on the LCD.

LCD Message	Description	Corrective Action
HDx Warning I11 Bad Sectors	The bad sectors in hard drive X may have reached a dangerous level.	Replace hard drive X.
Operation I12 DEGRADE MODE	Operating in degraded mode.	-
RAID I13 ARRAYxFormatting	Formatting RAID array X.	-
RAID I14 ARRAYx Checking	Checking RAID array X.	-
RAID I15 ARRAYx Scanning	Examining the error status of RAID array X. <b>Note:</b> Transfer speeds are slower during the examination process.	-
RAID I16 ARRAYx Creating	Creating RAID array X.	-
RAID I17 ARRAYx Resyncing	Resynchronizing RAID array X. <b>Note:</b> Transfer speeds are slower during resynchronization.	-

RAID I18 ARRAYx Rebuilding	Rebuilding RAID array X. <b>Note:</b> Transfer speeds are slower during the rebuilding process.	-
RAID I19 ARRAYx 0 Filling	Writing 0s to RAID array X, erasing all data.	-
RAID I20 DISKx Formatting	Formatting hard drive X.	-
RAID I21 DISKx Checking	Checking hard drive X.	-
RAID I22 DISKx 0 Filling	Erasing the data for hard drive X.	-
SYSTEM I25 F/WUPDATING	Updating the TeraStation firmware. <b>Note:</b> Do not turn off the power during the updating process.	-
Web Setting I26 Initializing	Initializing all settings.	-
USB Diskx I27 Checking	Checking USB hard drive X.	-
USB Diskx I28 Formatting	Formatting USB hard drive X.	-
Press FuncSW I31 New Diskx ready	Displayed when pressing the Function button to rebuild the RAID after replacing hard drive X.	Press the Function button to rebuild the RAID array.
Set From Web I32 New Diskx ready	Displayed after replacing hard drive X when the RAID needs to be rebuilt in Settings or formatting is necessary.	In Settings, either rebuild the RAID array or format the hard drive.
Replication I33 ReplicateFailure	An error occurred in replication, or synchronization between the main TeraStation and the backup TeraStation failed during failover configuration.	In Settings, navigate to Backup - Replication and choose "Resync" to execute resynchronization. If the error is displayed again, contact Buffalo technical support for assistance.
Virus alert I34 Virus detected	A virus scan found a virus.	Once the virus is removed from the quarantine folder, the message is no longer displayed. If the antivirus software is configured to delete viruses from the quarantine folder automatically, then the message will not be displayed.
Cartridgex I35 Location error	A hard drive set as a media cartridge has been installed in the drive 1 slot.	Connect to the slot that was set as a media cartridge.
Cartridgex I36 Decryption error	Media cartridge cannot be decrypted. The media cartridge may have been encrypted by a TeraStation other than this product.	Connect to the TeraStation that performed encryption to decrypt.
Recovery I37 SystemRecovering	System recovery in progress.	-
Recovery I38 RecoveryFinished	System recovery is complete.	-
Recovery I39 Change Boot	System recovery from the USB recovery device is complete.	Change the boot mode switch on the rear to HDD.
Recovery I40 DataWillDeleted	Beginning recovery. All data on the drive in Disk 1 will be deleted.	-



Recovery I41 PushFuncToStart	Pressing the Function button on the front will start the recovery process.	-
Recovery I42 Preparing	Preparing to start the recovery process.	-
Recovery I43 Unsupported HW	The TeraStation was started from the USB recovery device, but the system cannot be recovered from this USB recovery device.	-
Recovery I44 Disk1 not found	Recovery from the USB recovery device was initiated, but Disk 1 was not detected.	Make sure that Disk 1 is present and fully inserted in its slot.
Recovery I45 Recovery Failed	Recovery failed.	-
RAID ARRAY I46 RMM+Processing	Data migration or conversion (RAID migration) is in progress.	Do not turn off the TeraStation power.
SYSTEM I47 Don't Power Off		
FailOver I48 PushFuncToStart	This TeraStation is ready to become the failover backup for the main TeraStation.	Hold down the Function button on the front of the target TeraStation until it stops beeping to accept failover backup status.
FailOver I49 LostMainTarget	The main TeraStation in the failover configuration cannot be found.	Make sure that the main TeraStation is on, working, and connected to the network.
FailOver I50 Maintenance mode	Failover maintenance is in progress.	Do not turn off the TeraStation power.
FailOver I51 Initializing	Initializing the failover configuration.	Do not turn off the TeraStation power.
New Firmware I52 Available	A new firmware version has been released.	Update the firmware.
BackupTask xx I54 Backup Failure	xxth backup task has been failed.	Make sure xxth backup task is configured correctly. ("xx" is backup task number.) The LinkStation or TeraStation may be in standby mode. Start the NAS on. If the backup task still fails, check the status of NAS, network, and backup source or destinations.
Recovery I55 RecoveryAuthFail	Authentication during recovery of settings failed.	Settings can only be restored for the TeraStation whose settings were originally saved. To restore settings, insert the USB memory device, move the Boot Mode switch on the rear of the TeraStation to the USB position, and restart the TeraStation. Or, settings can be restored from Settings with the TeraStation powered on.
Surveillance I56 Lack of License	There are not enough surveillance camera server licenses.	Purchase and register an additional license.
Surveillance I57 No free space	There is not enough space to save additional surveillance video.	Delete or move some of the stored video.
Surveillance I58 Recording Failure	Video not recorded.	Check your settings. Also, use the utilities provided with your camera to check that the camera is operating correctly.

## Default Settings

Administrator's Name	admin
Password	password
Shared folders	"share" (for both Windows and Mac computers). The recycle bin is enabled on "share" by default.
DHCP Client	Normally, the TeraStation will get its IP address automatically from a DHCP server on the network. If no DHCP server is available, then an IP address will be assigned as follows: IP Address: 169.254.xxx.xxx (xxx is assigned randomly when booting the TeraStation.) Subnet Mask: 255.255.0.0
Registered Group	"hdusers", "admin" and "guest" You cannot edit or delete them.
Microsoft Network Group Setting	WORKGROUP
Ethernet Frame Size	1518 bytes (Including 14 bytes of the header and 4 bytes of FCS)
AFP	Enabled
FTP	Disabled
NTP	Enabled
Print Server	Enabled
WebAccess	Disabled
Time Machine	Disabled
TeraSearch	Disabled
RAID Mode	TS5800D, TS5600D: RAID 6 mode TS5400D TS5400R: RAID 5 mode TS5200D: RAID 1 mode

## Specifications

Check [www.buffalotech.com](http://www.buffalotech.com) for information about the latest products and specifications.

LAN port	Interface:	IEEE802.3ab (1000BASE-T) IEEE802.3u (100BASE-TX) IEEE802.3 (10BASE-T)
	Transfer speed:	1000 Mbps Full duplex (auto-negotiation) 100 Mbps Full duplex/Half duplex (auto-negotiation) 10 Mbps Full duplex/Half duplex (auto-negotiation)
	Number of ports	2 ports (supports AUTO-MDIX)
	Connector type	RJ-45 8-pin
	Protocol	TCP/IP
	Access method	CSMA/CD
	File Sharing	SMB/CIFS, AFP, FTP, SFTP, NFS
	Management	HTTP/HTTPS
Jumbo Frame	1518/4102/7422/9216 bytes (Including 14 bytes of the header and 4 bytes of FCS)	
USB Port	TS5800D, TS5600D, TS5400R: USB 2.0 Port (Series A) × 2, USB 3.0 Port (Series A) × 3 TS5400D, TS5200D: USB 2.0 Port (Series A) × 2, USB 3.0 Port (Series A) × 2 <b>Note:</b> Compatible USB devices: supported USB devices includes Buffalo USB hard drives, USB UPS devices, and printers	
UPS Port	UPS Port (D-SUB 9 pin (Male)) × 1 <b>Note:</b> Compatible UPS are manufactured by Omron or APC.	
Internal Hard Drive	If a hard drive in the TeraStation malfunctions, replace it with a Buffalo OP-HDS series drive of the same capacity, available from <a href="http://www.buffalotech.com">www.buffalotech.com</a> .	
Power Supply	AC 100-240 V, 50/60 Hz	
Power Consumption	TS5800D: max ~170 W TS5600D: max ~120 W TS5400D: max ~86 W TS5400R: max ~140 W TS5200D: max ~47 W	
Dimensions (W×H×D) / Weight	TS5800D: 300 x 215 x 230 mm; 11.8" x 8.5" x 9.1" (excluding protruding parts)/ ~ 12 kg (26.5 lb.) TS5600D: 170 x 260 x 230 mm; 6.7" x 10.2" x 9.1" (excluding protruding parts)/ ~ 10 kg (22.1 lb.) TS5400D: 170 x 215 x 230 mm; 6.7" x 8.5" x 9.1" (excluding protruding parts)/ ~ 8 kg (17.7 lb.) TS5400R: 430 x 45 x 430 mm; 16.9" x 1.7" x 16.9" (excluding protruding parts)/ ~ 9 kg (19.8 lb.) TS5200D: 170 x 170 x 230 mm; 6.7" x 6.7" x 9.1" (excluding protruding parts)/ ~ 4.5 kg (10 lb.)	
Operating Environment	Temperature: 5 - 35° C; 41 - 95° F Environment Humidity: 20 - 80% (no condensation)	
Compatibility	Windows and Mac computers with Ethernet interface. <b>Note:</b> The TeraStation requires an Ethernet connection with your computer for operation. It cannot be connected via USB.	

Supported OS	Windows 8*, Windows 7*, Windows Vista*, Windows XP, Windows XP Media Center Edition (2004 or 2005), Windows Server 2008, Windows Server 2003, Windows 2000 Server OS X 10.7, 10.6, 10.5, 10.4, 10.3.9 *32-bit and 64-bit
--------------	--

## Compliance Information

The TeraStation uses GPL code. For source code, visit <http://opensource.buffalo.jp>

### FCC Warning

---

This equipment has been tested and found to comply with the limits for a Class A digital device, pursuant to Part 15 of the FCC Rules. These limits are designed to provide reasonable protection against harmful interference when the equipment is operated in a commercial environment. This equipment generates, uses, and can radiate radio frequency energy and, if not installed and used in accordance with the instruction manual, may cause harmful interference to radio communications. Operation of this equipment in a residential area is likely to cause harmful interference in which case the user will be required to correct the interference at his own expense.

### CE Mark Warning

---

CE Mark Warning

This is a Class A product. In a domestic environment, this product may cause radio interference, in which case the user may be required to take adequate measures.

### Environmental Information

---

- The equipment that you have purchased required the extraction and use of natural resources for its production.
- The equipment may contain hazardous substances that could impact health and the environment.
- In order to avoid the dissemination of those substances in our environment and to diminish the load on natural resources, we encourage you to use the appropriate take-back systems.
- The take-back systems will reuse or recycle most of the materials of your end of life equipment appropriately.
- The crossed-out wheeled bin symbol invites you to use those systems.

If you need more information on the collection, reuse and recycling systems, please contact your local or regional waste administration.



### KC

---

기종별	사 용 자 안 내 문
-----	-------------

A급기기(업무용 정보통신기기)	이 기기는 업무용(A급) 전자파적합기기로서 판매자 또는 사용자는 이 점을 주의하시기 바라며, 가정외의 지역에서 사용하는 것을 목적으로 합니다.
------------------	---

## BSMI

---

警告使用者：

這是甲類的資訊產品，在居住的環境中使用時，可能會造成射頻干擾，在這種情況下，使用者會被要求採取某些適當的對策。

## CCC

---

声明：

此为A级产品，在生活环境中，该产品可能会造成无线电干扰。在这种情况下，可能需要用户对其干扰采取切实可行的措施。

设备的最高使用室内环境温度: 35° C



仅适用于海拔 2000M 以下地区安全使用。

断开装置为电源软线上的插头。插座应当装在设备的附近，而且应当便于触及到。

## 电池警告语

---

1. 电池不得暴露。
2. 使用型号不正确的电池可能导致爆炸。

## Models

---

TS5200D0202, TS5200D0402, TS5200D0602, TS5200D0802, TS5200D  
 TS5400D0404, TS5400D0804, TS5400D1204, TS5400D1604, TS5400D  
 TS5600D2406, TS5600D1806, TS5600D1206, TS5600D0606, TS5600D  
 TS5800D3208, TS5800D2408, TS5800D1608, TS5800D0808, TS5800D  
 TS5400R0404, TS5400R0804, TS5400R1204, TS5400R1604, TS5400R