



Contact SAMSUNG WORLDWIDE

If you have any questions or comments relating to Samsung products, please contact the SAMSUNG customer care centre.

Country	Customer Care Centre ☎	Web Site
ALBANIA	42 27 5755	-
AUSTRIA	0810 - SAMSUNG (7267864, € 0.07/min)	www.samsung.com
BELGIUM	02-201-24-18	www.samsung.com/be (Dutch) www.samsung.com/be_fr (French)
BOSNIA	05 133 1999	-
BULGARIA	07001 33 11	www.samsung.com
CROATIA	062 SAMSUNG (062 726 7864)	www.samsung.com
CZECH	800 - SAMSUNG (800-726786) Samsung Zrt., česká organizační složka, Oasis Florenc, Sokolovská394/17, 180 00, Praha 8	www.samsung.com
DENMARK	70 70 19 70	www.samsung.com
FINLAND	030 - 6227 515	www.samsung.com
FRANCE	01 48 63 00 00	www.samsung.com
GERMANY	01805 - SAMSUNG(726-7864 € 0,14/Min)	www.samsung.com
GREECE	"1. Για προϊόντα πληροφορικής και κινητής τηλεφωνίας Από σταθερό 80111-SAMSUNG (80111 7267864), αστική χρέωση Από κινητό 210 6897691 2. Για φωτογραφικές μηχανές, βιντεοκάμερες, τηλεοράσεις & οικιακές συσκευές Από κινητό και σταθερό 2106293100"	www.samsung.com
HUNGARY	06-80-SAMSUNG(726-7864)	www.samsung.com
ITALIA	800-SAMSUNG(726-7864)	www.samsung.com
KOSOVO	+381 0113216899	-
LUXEMBURG	261 03 710	www.samsung.com
MACEDONIA	023 207 777	-
MONTENEGRO	020 405 888	-
NETHERLANDS	0900-SAMSUNG (0900-7267864) (€ 0,10/Min)	www.samsung.com
NORWAY	815-56 480	www.samsung.com
POLAND	0 801 1SAMSUNG(172678) / 022-607-93-33	www.samsung.com
PORTUGAL	80820-SAMSUNG(726-7864)	www.samsung.com
RUMANIA	"1. 08010 SAMSUNG (72678) – doar din rețeaua Romtelecom, tarif local; 2. 021.206.01.10 – din orice rețea, tarif normal "	www.samsung.com
SERBIA	0700 Samsung (0700 726 7864)	www.samsung.com
SLOVAKIA	0800 - SAMSUNG(0800-726 786)	www.samsung.com/sk
SPAIN	902 - 1 - SAMSUNG (902 172 678)	www.samsung.com
SWEDEN	0771 726 7864 (SAMSUNG)	www.samsung.com
SWITZERLAND	0848 - SAMSUNG(7267864, CHF 0.08/min)	www.samsung.com/ch www.samsung.com/ch_fr(French)
U.K	0330 SAMSUNG (7267864)	www.samsung.com
EIRE	0818 717100	www.samsung.com
LITHUANIA	8-800-77777	www.samsung.com
LATVIA	8000-7267	www.samsung.com
ESTONIA	800-7267	www.samsung.com
TURKEY	444 77 11	www.samsung.com



LED TV User Manual

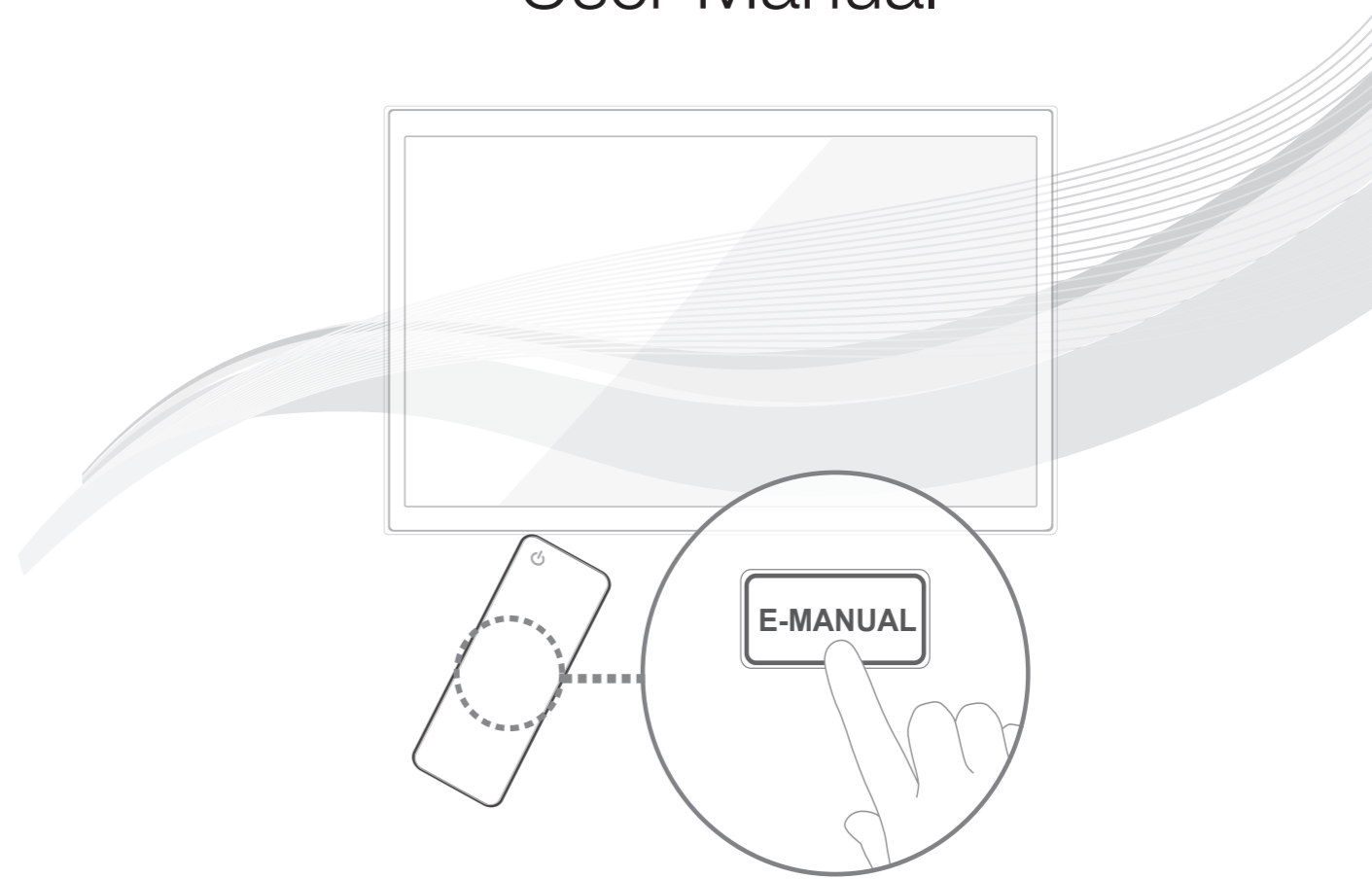

imagine the possibilities

Thank you for purchasing this Samsung product.
To receive more complete service, please register
your product at
www.samsung.com/register

Model _____ Serial No. _____



BN68-03420F-02

For more information on how to use e-Manual (P. 12)

Figures and illustrations in this User Manual are provided for reference only and may differ from actual product appearance. Product design and specifications may be changed without notice.

Important Warranty Information Regarding Television Format Viewing

1. Functionalities related to Digital TV (DVB) are only available in countries/areas where DVB-T (MPEG2 and MPEG4 AVC) digital terrestrial signals are broadcasted or where you are able to access to a compatible DVB-C (MPEG2 and MPEG4 AAC) cable-TV service. Please check with your local dealer the possibility to receive DVB-T or DVB-C signal.
2. DVB-T is the DVB European consortium standard for the broadcast transmission of digital terrestrial television and DVB-C is that for the broadcast transmission of digital TV over cable. However, some differentiated features like EPG (Electric Programme Guide), VOD (Video On Demand) and so on, are not included in this specification. So, they cannot be workable at this moment.
3. Although this TV set meets the latest DVB-T and DVB-C standards, as of [August, 2008], the compatibility with future DVB-T digital terrestrial and DVB-C digital cable broadcasts cannot be guaranteed.
4. Depending on the countries/areas where this TV set is used some cable-TV providers may charge an additional fee for such a service and you may be required to agree to terms and conditions of their business.
5. Some Digital TV functions might be unavailable in some countries or regions and DVB-C might not work correctly with some cable service providers.
6. For more information, please contact your local Samsung customer care centre.

 The reception quality of TV may be affected due to differences in broadcasting method between the countries. Please check the TV performance in the local SAMSUNG Authorized Dealer, or the Samsung Call Centre whether it can be improved by reconfiguring TV setting or not.



Still image warning

Avoid displaying still images (like jpeg picture files) or still image element (like TV programme logo, panorama or 4:3 image format, stock or news bar at screen bottom etc.) on the screen. Constant displaying of still picture can cause ghosting of LED screen, which will affect image quality. To reduce risk of this effect, please follow below recommendations:

- Avoid displaying the same TV channel for long periods.
- Always try to display any image on full screen, use TV set picture format menu for best possible match.
- Reduce brightness and contrast values to minimum required to achieve desired picture quality, exceeded values may speed up the burnout process.
- Frequently use all TV features designed to reduce image retention and screen burnout, refer to proper user manual section for details.

Securing the Installation Space

Keep the required distances between the product and other objects (e.g. walls) to ensure proper ventilation. Failing to do so may result in fire or a problem with the product due to an increase in the internal temperature of the product.

-  When using a stand or wall-mount, use parts provided by Samsung Electronics only.
 - If you use parts provided by another manufacturer, it may result in a problem with the product or an injury due to the product falling.
-  The appearance may differ depending on the product.
-  Be careful when you contact the TV because some parts can be somewhat hot.

Installation with a stand.

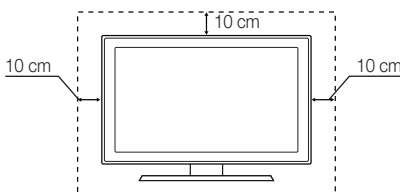

Installation with a wall-mount.

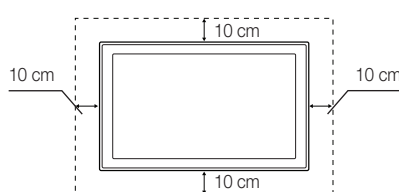

Correct Disposal of This Product (Waste Electrical & Electronic Equipment)

(Applicable in the European Union and other European countries with separate collection systems)

This marking on the product, accessories or literature indicates that the product and its electronic accessories (e.g. charger, headset, USB cable) should not be disposed of with other household waste at the end of their working life. To prevent possible harm to the environment or human health from uncontrolled waste disposal, please separate these items from other types of waste and recycle them responsibly to promote the sustainable reuse of material resources. Household users should contact either the retailer where they purchased this product, or their local government office, for details of where and how they can take these items for environmentally safe recycling. Business users should contact their supplier and check the terms and conditions of the purchase contract. This product and its electronic accessories should not be mixed with other commercial wastes for disposal.



Correct disposal of batteries in this product

(Applicable in the European Union and other European countries with separate battery return systems)

This marking on the battery, manual or packaging indicates that the batteries in this product should not be disposed of with other household waste at the end of their working life. Where marked, the chemical symbols Hg, Cd or Pb indicate that the battery contains mercury, cadmium or lead above the reference levels in EC Directive 2006/66. If batteries are not properly disposed of, these substances can cause harm to human health or the environment. To protect natural resources and to promote material reuse, please separate batteries from other types of waste and recycle them through your local, free battery return system.



Accessories

- ✎ Please make sure the following items are included with your TV. If any items are missing, contact your dealer.
- ✎ The items' colours and shapes may vary depending on the models.
- ✎ Cables not included in the package contents can be purchased separately.

⚠ CAUTION: INSERT SECURELY LEST SHOULD BE DETACHED IN SET

- Remote Control & Batteries (AAA x 2)
- Owner's Instructions
- Warranty Card / Safety Guide (Not available in some locations)
- Power Cord
- Cleaning Cloth

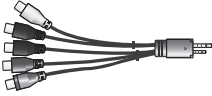

• Component / AV Adapter



• Scart Adapter







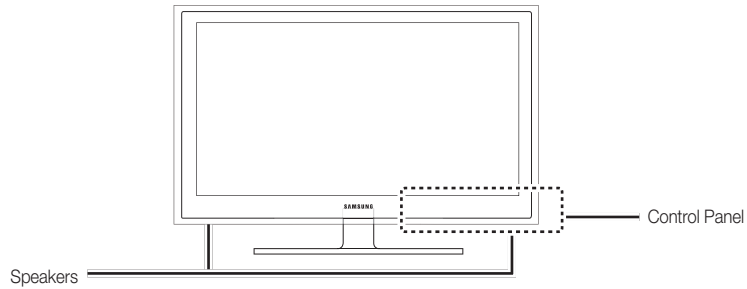

• CI Card Adapter

- ✎ An administration fee may be charged if either
 - (a) an engineer is called out at your request and there is no defect in the product (i.e. where you have failed to read this user manual)
 - (b) you bring the unit to a repair centre and there is no defect in the product (i.e. where you have failed to read this user manual).
- ✎ The amount of such administration charge will be advised to you before any work or home visit is carried out.

Viewing the Control Panel

 The product colour and shape may vary depending on the model.



Remote control sensor	Aim the remote control towards this spot on the TV.
Power Indicator	Blinks and turns off when the power is on and lights up in standby mode.
SOURCE 	Toggles between all the available input sources. In the on-screen menu, use this button as you would use the ENTER  button on the remote control.
MENU	Displays an on-screen menu, the OSD (on screen display) of your TV's features.
-  +	Adjusts the volume. In the OSD, use the -  + buttons as you would use the ◀ and ▶ buttons on the remote control.
▼ CH ▲	Changes the channels. In the OSD, use the ▼ CH ▲ buttons as you would use the ▼ and ▲ buttons on the remote control.
 (Power)	Turns the TV on or off.

Standby mode

Do not leave your TV in standby mode for long periods of time (when you are away on a holiday, for example). A small amount of electric power is still consumed even when the power button is turned off. It is best to unplug the power cord.

Viewing the Remote Control

This is a special remote control for the visually impaired persons and has Braille points on the Power, Channel, and Volume buttons.

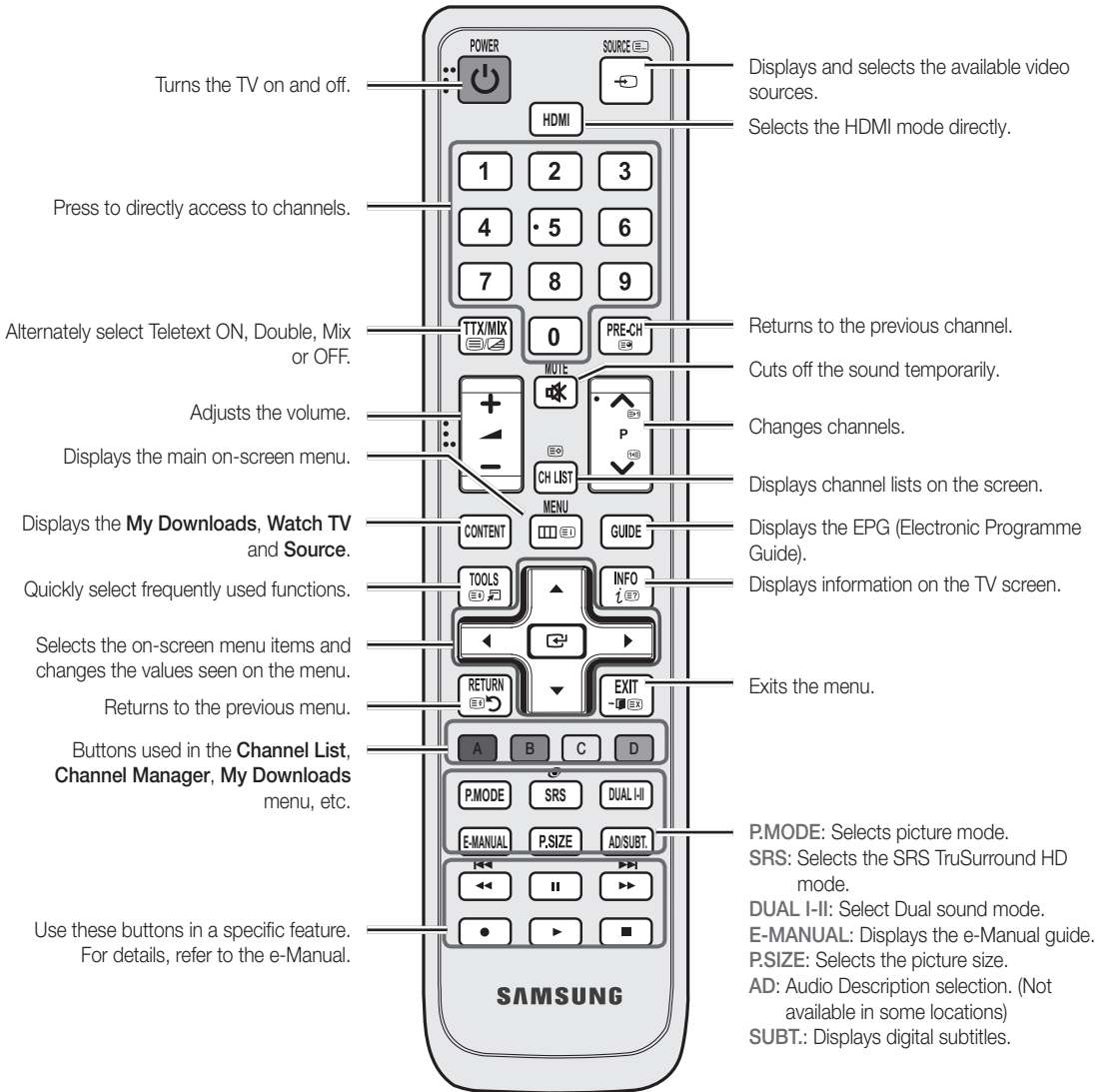

Installing batteries (Battery size: AAA)

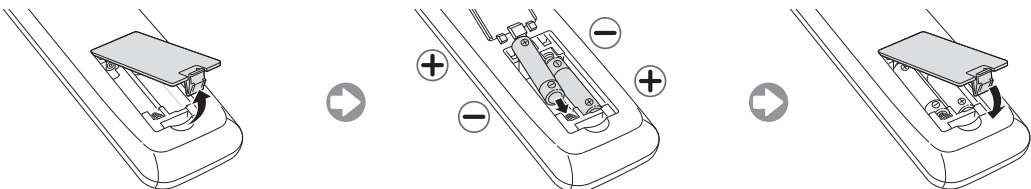

Connecting to an Antenna

When the TV is initially powered on, basic settings proceed automatically.

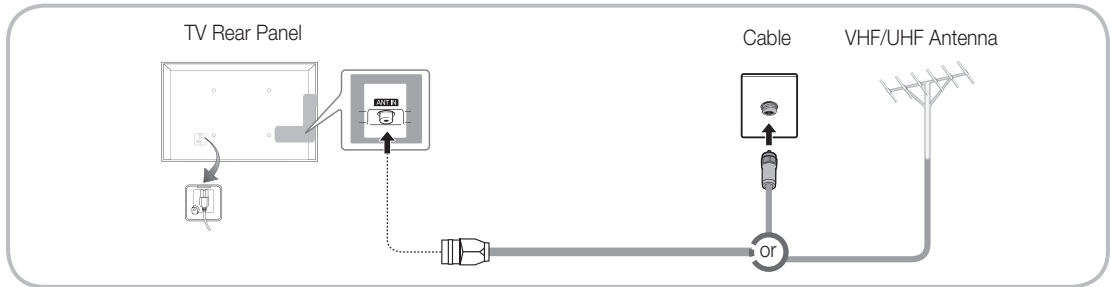

 **Preset:** Connecting the mains and antenna.



Plug & Play (Initial Setup)

When the TV is initially powered on, a sequence of on-screen prompts will assist in configuring basic settings. Press the **POWER** button. **Plug & Play** is available only when the input source is set to TV.

 To return to the previous step, press the Red button.

1	Selecting a language	Press the ▲ or ▼ button, then press the ENTER button. Select the desired OSD (On Screen Display) language.	
2	Selecting Store Demo or Home Use	Press the ◀ or ▶ button, then press the ENTER button. Select the Home Use mode. Store Demo mode is for retail environments. To return the unit's settings from Store Demo to Home Use (standard): Press the volume button on the TV. When the OSD volume is displayed, press and hold MENU for 5 sec. Store Demo is only for shop display. If you select it, several functions are not able to use. Please select Home Use when you watch at home.	
3	Selecting a country	Press the ▲ or ▼ button, then press the ENTER button. Select the appropriate country.  The option may differ depending on country.	
4	Setting the Clock Mode	Set the Clock Mode automatically or manually. Auto: Select the time zone (depending on the country) where you are located. Manual: Allows you to manually set the current date and time.	
5	Selecting an antenna	Press the ▲ or ▼ button, then press the ENTER button. Select the desired broadcasting signal.	
6	Selecting a channel	Press the ▲ or ▼ button, then press the ENTER button. Select the channel source to memorise. When setting the antenna source to Cable , a step appears allowing you to assign numerical values (channel frequencies) to the channels. For more information, refer to Channel → Auto Tuning . Press the ENTER button at any time to interrupt the memorisation process.	
7	Enjoy your TV.	Select the Watch TV . Press the ENTER button.	

If You Want to Reset This Feature...

Select **System - Plug & Play** (Initial Setup). Enter your 4 digit PIN number. The default PIN number is "0-0-0-0". If you want to change the PIN number, use the **Change PIN** function.

You should do **Plug & Play** (MENU → **System**) again at home although you did in shop.

 If you forget the PIN code, press the remote control buttons in the following sequence in Standby mode, which resets the PIN to "0-0-0-0": MUTE → 8 → 2 → 4 → POWER (on).

Connecting to an AV devices

Available devices: DVD, Blu-ray player, HD cable box, HD STB (Set-Top-Box) satellite receiver, VCR, Digital Audio System, Amplifier, DVD Home Theatre, PC

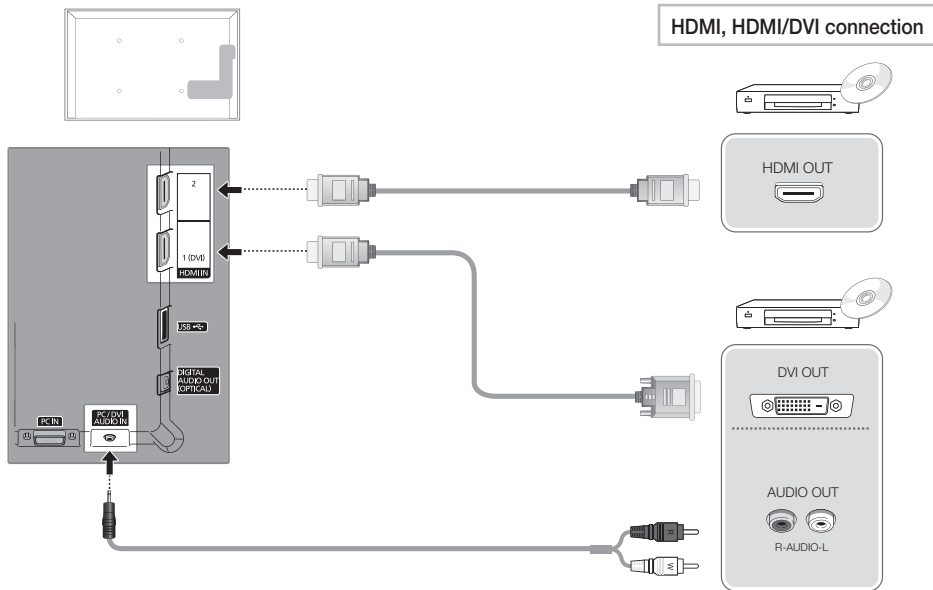



Using an HDMI cable or HDMI to DVI Cable (up to 1080p)

HDMI IN 1(DVI), 2, PC/DVI AUDIO IN

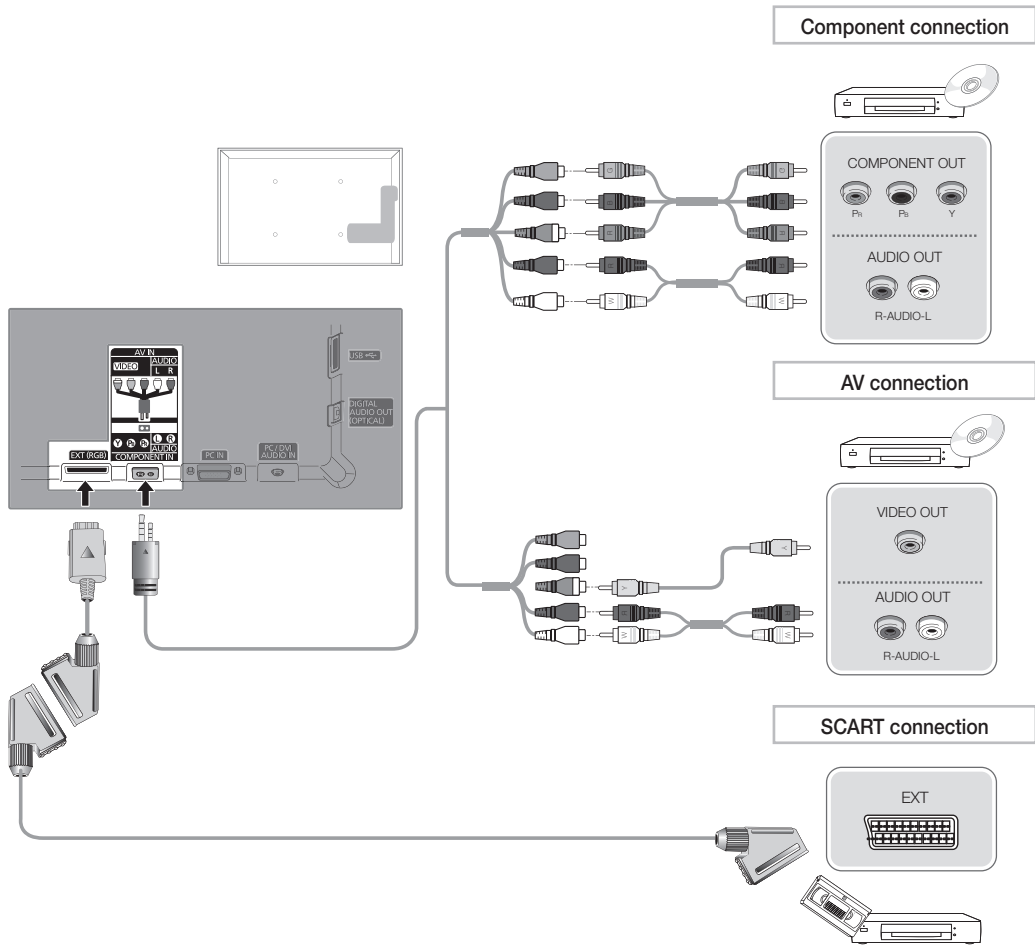
- For better picture and audio quality, connect to a digital device using an HDMI cable.
- An HDMI cable supports digital video and audio signals, and does not require an audio cable.
 - To connect the TV to a digital device that does not support HDMI output, use an HDMI/DVI and audio cables.
- The picture may not display normally (if at all) or the audio may not work if an external device that uses an older version of HDMI mode is connected to the TV. If such a problem occurs, ask the manufacturer of the external device about the HDMI version and, if out of date, request an upgrade.
- Be sure to use an HDMI cable with a thickness of 14 mm or less.
- Be sure to purchase a certified HDMI cable. Otherwise, the picture may not display or a connection error may occur.
- A basic high-speed HDMI cable or one with ethernet is recommended. This product does not support the ethernet function via HDMI.



Using a Component (up to 1080p) or Audio/Video (480i only) and Scart Cable

-  In **Ext.** mode, DTV Out supports MPEG SD Video and Audio only.
-  To obtain the best picture quality, the Component connection is recommended over the A/V connection.

Available devices: Digital Audio System, Amplifier, DVD Home Theatre

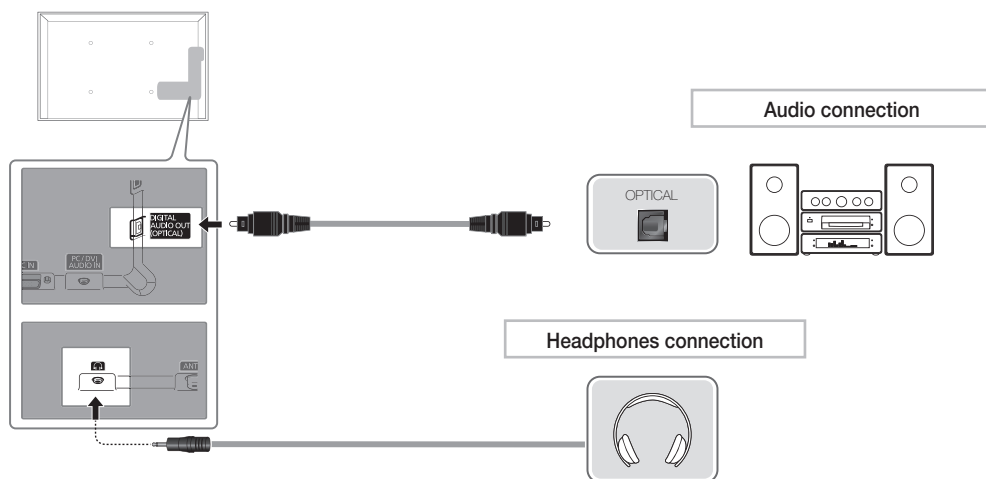

Using an Optical (Digital) or Audio (Analogue) Cable or Headphone Connection

DIGITAL AUDIO OUT (OPTICAL)

- When a digital audio system is connected to the **DIGITAL AUDIO OUT (OPTICAL)** jack, decrease the volume of both the TV and the system.
- 5.1 CH (channel) audio is available when the TV is connected to an external device supporting 5.1 CH.
- When the receiver (home theatre) is set to on, you can hear sound output from the TV's optical jack. When the TV is receiving a DTV signal, the TV will send 5.1 CH sound to the home theatre receiver. When the source is a digital component such as a DVD / Blu-ray player / cable box / STB (Set-Top-Box) satellite receiver and is connected to the TV via HDMI, only 2 CH audio will be heard from the home theatre receiver. If you want to hear 5.1 CH audio, connect the digital audio out jack from your DVD / Blu-ray player / cable box / STB satellite receiver directly to an amplifier or home theatre.

Headphones : You can connect your headphones to the headphones output on your set. While the headphones are connected, the sound from the built-in speakers will be disabled.

- Sound function may be restricted when connecting headphones to the TV.
- Headphone volume and TV volume are adjusted separately.

Using an HDMI cable or HDMI to DVI Cable / a D-sub Cable

- ✎ Connecting through the HDMI cable may not be supported depending on the PC.
- ✎ An HDMI cable supports digital video and audio signals, and does not require an audio cable.

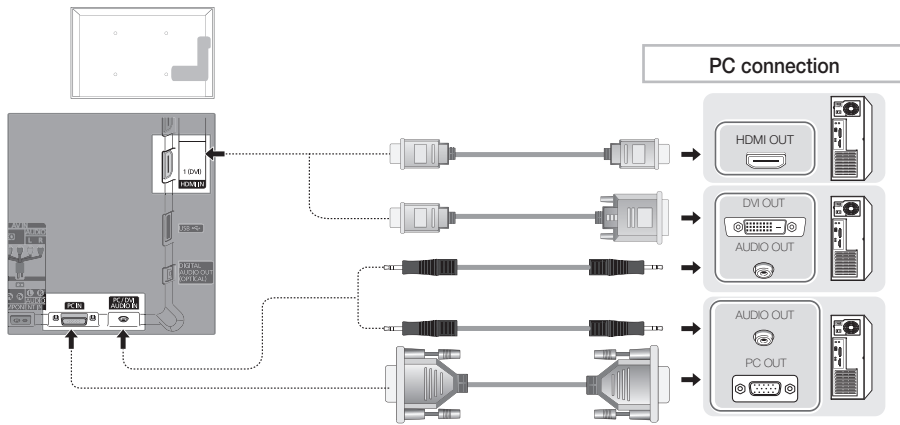

Display Modes (D-Sub and HDMI/DVI Input)

Optimal resolution is 1360 x 768 @ 60Hz.

Mode	Resolution	Horizontal Frequency (KHz)	Vertical Frequency (Hz)	Pixel Clock Frequency (MHz)	Sync Polarity (H / V)
IBM	640 x 350	31.469	70.086	25.175	+ / -
	720 x 400	31.469	70.087	28.322	- / +
MAC	640 x 480	35.000	66.667	30.240	- / -
	832 x 624	49.726	74.551	57.284	- / -
VESA DMT	640 x 480	31.469	59.940	25.175	- / -
		37.861	72.809	31.500	- / -
		37.500	75.000	31.500	- / -
	800 x 600	37.879	60.317	40.000	+ / +
		48.077	72.188	50.000	+ / +
		46.875	75.000	49.500	+ / +
	1024 x 768	48.363	60.004	65.000	- / -
		56.476	70.069	75.000	- / -
		60.023	75.029	78.750	+ / +
	1360 x 768	47.712	60.015	85.500	+ / +

NOTE

- For HDMI/DVI cable connection, you must use the HDMI IN 1 (DVI) jack.
- The interlace mode is not supported.
- The set might operate abnormally if a non-standard video format is selected.
- Separate and Composite modes are supported. SOG(Sync On Green) is not supported.

Changing the Input Source

Source List

Use to select TV or other external input sources such as DVD / Blu-ray players / cable box / STB satellite receiver connected to the TV.

SOURCE

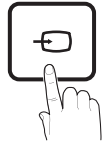

■ TV / Ext. / PC / AV / Component / HDMI1/DVI / HDMI2 / USB

- In the Source List, connected inputs will be highlighted.
- If you want to see connected devices only, move to **Connected** using ◀ or ▶ button.
- Ext.** and **PC** always stay activated.
- If the connected external devices are not highlighted, press the red button. The TV will search for connected devices.

How to use Edit Name

In the Source, press the TOOLS button, and then you can set an external input sources name you want.

■ VCR / DVD / Cable STB / Satellite STB / PVR STB / AV Receiver / Game / Camcorder / PC / DVI PC / DVI Devices / TV / IPTV / Blu-ray / HD DVD / DMA: Name the device connected to the input jacks to make your input source selection easier.

- When connecting a PC to the HDMI IN 1(DVI) port with HDMI cable, you should set the TV to **PC** mode under **Edit Name**.
- When connecting a PC to the HDMI IN 1(DVI) port with HDMI to DVI cable, you should set the TV to **DVI PC** mode under **Edit Name**.
- When connecting an AV devices to the HDMI IN 1(DVI) port with HDMI to DVI cable, you should set the TV to **DVI Devices** mode under **Edit Name**.

Information

You can see detailed information about the selected external device.

- For best cable connection to this product, be sure to use cables with a maximum thickness as below:

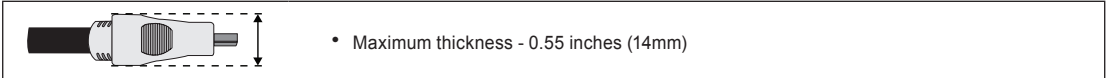

Connecting to a COMMON INTERFACE slot

Attaching the CI Card Adaptor

Attach the adaptor as shown in the right.

To connect the CI CARD Adaptor, follow these steps.

- Make sure that you attach the adaptor before you mount the TV on a wall.
1. Insert the CI CARD Adaptor into the two holes on the product .
 - Please find a two hole on the rear of the TV. A two holes is beside the COMMON INTERFACE port.
 - Press it firmly at center of adaptor to ensure it is fully lock.
 2. Connect the CI CARD Adaptor into the COMMON INTERFACE port.
 3. Insert the "CI or CI+ CARD".

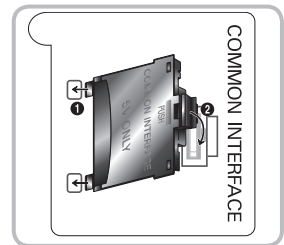

Using the "CI or CI+ CARD"

To watch paid channels, the "CI or CI+ CARD" must be inserted.

- If you do not insert the "CI or CI+ CARD," some channels will display the message "Scrambled Signal".
- The pairing information containing a telephone number, the "CI or CI+ CARD" ID the Host ID and other information will be displayed in about 2-3 minutes. If an error message is displayed, please contact your service provider.
- When the configuration of channel information has finished, the message "Updating Completed" is displayed, indicating the channel list is updated.

NOTE

- You must obtain a "CI or CI+ CARD" from a local cable service provider.
- When removing the "CI or CI+ CARD", carefully pull it out with your hands since dropping the "CI or CI+ CARD" may cause damage to it.
- Insert the "CI or CI+ CARD" in the direction marked on the card.
- The location of the COMMON INTERFACE slot may be different depending on the model.
- "CI or CI+ CARD" is not supported in some countries and regions; check with your authorized dealer.
- If you have any problems, please contact a service provider.
- Insert the "CI or CI+ CARD" that supports the current antenna settings. The screen will be distorted or will not be seen.

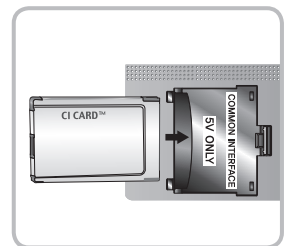

How to view the e-Manual



You can find instructions about your TV's features in the **e-Manual** in your TV. To use, press the **E-MANUAL** button on your remote. Move the cursor using the up/down/right/left buttons to highlight a category, then a topic, and then press the **ENTER** button. The **e-Manual** displays the page you want to see.

You can also access it through the menu:

MENU → **Support** → **e-Manual** → **ENTER**

To return to the **e-Manual** main menu, press the **E-MANUAL** button on the remote.

You cannot use **Try Now** directly if the TV is set to an external input source.

Screen Display

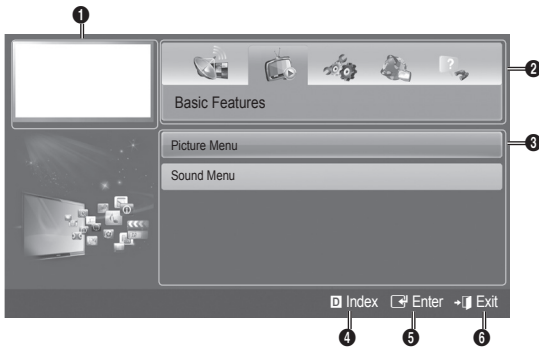

- ❶ Currently displayed video, TV Programme, etc.
- ❷ The category list. Press ◀ or ▶ button to select category you want.
- ❸ Displays the sub-menu list. Use the arrow buttons on your remote to move the cursor. Press **ENTER** button to select the sub-menu you want.
- ❹ **D Blue (Index)**: Displays the index screen.
- ❺ **Enter**: Selects a category or sub-menu.
- ❻ **Exit**: Exit the **e-Manual**.

How to toggle between an e-Manual topic and the corresponding OSD menu(s).

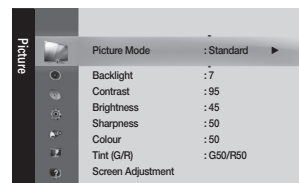
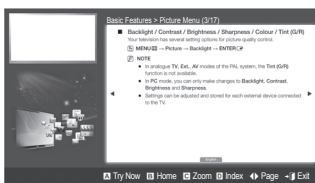

This function is not enabled in some menus.

Method 1

1. If you want to use the menu that corresponds to an **e-Manual** topic, press the red button to select **Try Now**.
2. To return to the **e-Manual** screen, press the **E-MANUAL** button.

Method 2

1. Press the **ENTER** button when a topic is displayed. "**Are you sure?**" appears. Select **Yes**, and then press the **ENTER** button. The OSD window appears.
2. To return to the **e-Manual** screen, press the **E-MANUAL** button.

Viewing the Contents

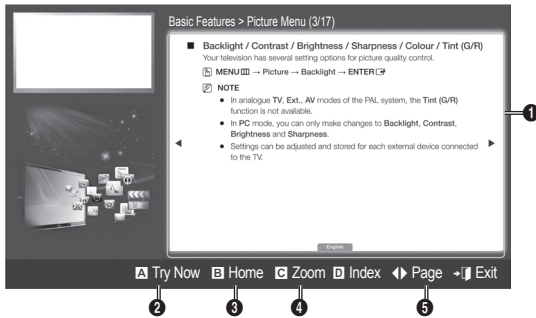

- 1 Contents Area: Contains the topic contents, if you selected a sub-menu. To move previous or next page, press the ◀ / ▶ button.
- 2 Try Now: Displays the OSD menu that corresponds to the topic. To return to the e-Manual screen, press the E-MANUAL button.
- 3 Home: Moves to the e-Manual home screen.
- 4 Zoom: Magnifies a screen. You can scroll through the magnified screen by using ▲ / ▼ buttons.
- 5 ◀▶ (Page): Moves to previous or next page.

Using the Zoom mode

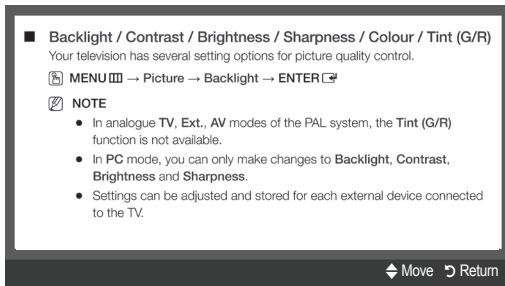

Select the **Zoom**, and then press ENTER [] to magnify the screen. You can scroll through the magnified screen by using the ▲ or ▼ buttons.

To return to the screen to normal size, press the RETURN button.

How to search for a topic on the index page

This function may not be supported depending on the language.

1. If you want to search a keyword, press the blue button to select **Index**.
2. Press the ◀ or ▶ button to select a character order you want.
3. Press the ▲ or ▼ button to select a keyword you want to see, and then press the ENTER [] button.
4. You can view the corresponding e-Manual instruction screen.

To close the **Index** screen, press the RETURN button.

Installing the Wall Mount

The wall mount kit (sold separately) allows you to mount the TV on the wall.

For detailed information on installing the wall mount, see the instructions provided with the wall mount. Contact a technician for assistance when installing the wall mount bracket.

Samsung Electronics is not responsible for any damage to the product or injury to yourself or others if you elect to install the TV on your own.

Wall Mount Kit Specifications (VESA)

Case A. Installing the SAMSUNG Wall-Mount

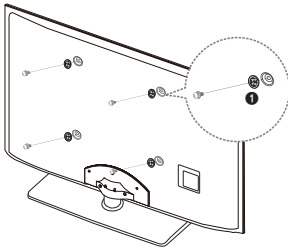

Case B. Installing another company's Wall-Mount

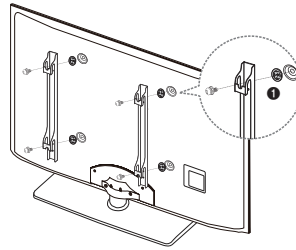

Wall mount kit is not supplied but sold separately.

Install your wall mount on a solid wall perpendicular to the floor. When attaching to other building materials, please contact your nearest dealer. If installed on a ceiling or slanted wall, it may fall and result in severe personal injury.

NOTE

- Standard dimensions for wall mount kits are shown in the table below.
- When purchasing our wall mount kit, a detailed installation manual and all parts necessary for assembly are provided.
- Do not use screws that do not comply with the VESA standard screw specifications.
- Do not use screws longer than the standard dimension, as they may cause damage to the inside of the TV set.
- For wall mounts that do not comply with the VESA standard screw specifications, the length of the screws may differ depending on their specifications.
- Do not fasten the screws too strongly, this may damage the product or cause the product to fall, leading to personal injury. Samsung is not liable for these kinds of accidents.
- Samsung is not liable for product damage or personal injury when a non-VESA or non-specified wall mount is used or the consumer fails to follow the product installation instructions.
- Do not exceed 15 degrees tilt when mounting this TV.

Product Family	inches	VESA Spec. (A * B)	Standard Screw	Quantity
LED-TV	19~22	75 X 75	M4	4
	27	200 X 100		
	32~40	200 X 200	M8	
	46~60	400 X 400		
	65~75	600 X 400		

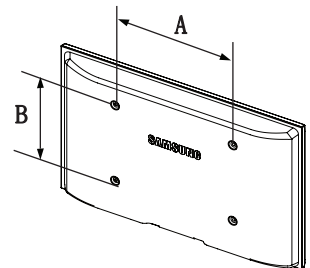

Do not install your Wall Mount Kit while your TV is turned on. It may result in personal injury due to electric shock.

Troubleshooting

If the TV seems to have a problem, first try this list of possible problems and solutions. If none of these troubleshooting tips apply, visit "www.samsung.com," then click on Support, or call Samsung customer service centre.

Issues	Solutions and Explanations
The TV will not turn on.	<ul style="list-style-type: none"> • Make sure the AC power cord is securely plugged in to the wall outlet and the TV. • Make sure the wall outlet is working. • Try pressing the POWER button on the TV to make sure the problem is not the remote. If the TV turns on, refer to "Remote control does not work" below.
There is no picture/video.	<ul style="list-style-type: none"> • Check cable connections (remove and reconnect all cables connected to the TV and external devices). • Set your external device's (Cable/Set top Box, DVD, Blu-ray etc) video outputs to match the connections to the TV input. For example, if an external device's output is HDMI, it should be connected to an HDMI input on the TV. • Make sure your connected devices are powered on. • Be sure to select the TV's correct source by pressing the SOURCE button on the remote control. • Reboot the connected device by reconnecting the device's power cable.
The remote control does not work.	<ul style="list-style-type: none"> • Replace the remote control batteries with the poles (+/-) in the right direction. • Clean the sensor's transmission window on the remote. • Try pointing the remote directly at the TV from 5-6 feet away.
The cable/set top box remote control doesn't turn the TV on or off, or adjust the volume.	<ul style="list-style-type: none"> • Program the Cable/Set top box remote control to operate the TV. Refer to the Cable/Set user manual for the SAMSUNG TV code.

 You can keep your TV as optimum condition to upgrade the latest firmware on web site (samsung.com -> Support -> Downloads) by USB.

 This TFT LED panel uses a panel consisting of sub pixels which require sophisticated technology to produce. However, there may be a few bright or dark pixels on the screen. These pixels will have no impact on the performance of the product.

Licence



List of Features

Excellent Digital Interface & Networking: With a built-in HD digital tuner, nonsubscription HD broadcasts can be viewed without a cable box / STB (Set-Top-Box) satellite receiver.

My Downloads

Allows you to play music files, pictures, and movies saved on a USB device.

Anynet+(HDMI-CEC)

Allows you to control all connected Samsung devices that support Anynet+ with your Samsung TV's remote.

Securing the TV to the Wall



Caution: Pulling, pushing, or climbing onto the TV may cause the TV to fall. In particular, ensure that your children do not hang over or destabilize the TV; doing so may cause the TV to tip over, resulting in serious injuries or death. Follow all safety precautions provided on the included Safety Flyer. For added stability, install the anti-fall device for safety purposes, as follows.

To avoid the TV from falling

1. Put the screws into the clamps and firmly fasten them onto the wall. Confirm that the screws have been firmly installed onto the wall.

- You may need additional material such as an anchor depending on the type of wall.
- Since the necessary clamps, screws, and string are not supplied, please purchase these additionally.

2. Remove the screws from the centre back of the TV, put the screws into the clamps, and then fasten the screws onto the TV again.

- Screws may not be supplied with the product. In this case, please purchase the screws of the following specifications.
- Screw Specifications

- For a 19 Inch LED TV: M4

3. Connect the clamps fixed onto the TV and the clamps fixed onto the wall with a strong string and then tie the string tightly.

NOTE

- Install the TV near to the wall so that it does not fall backwards.
- It is safe to connect the string so that the clamps fixed on the wall are equal to or lower than the clamps fixed on the TV.
- Untie the string before moving the TV.

4. Verify all connections are properly secured. Periodically check connections for any sign of fatigue for failure. If you have any doubt about the security of your connections, contact a professional installer.

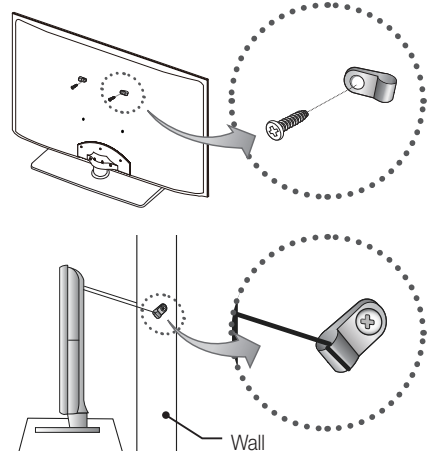

Storage and Maintenance

- If you remove the attached sticker on the TV screen, clean the residues and then watch TV.

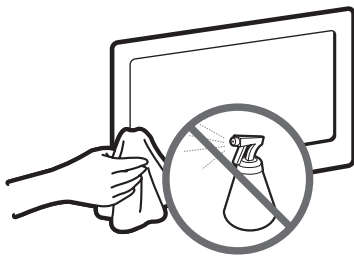

Do not spray water or a cleaning agent directly onto the product. Any liquid that goes into the product may cause a failure, fire, or electric shock.

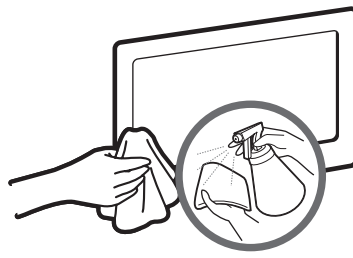

Clean the product with a soft cloth dipped in a small amount of water.

Specifications

Display Resolution	1360 X 768
Environmental Considerations	
Operating Temperature	10°C to 40°C (50°F to 104°F)
Operating Humidity	10% to 80%, non-condensing
Storage Temperature	-20°C to 45°C (-4°F to 113°F)
Storage Humidity	5% to 95%, non-condensing
TV System	Analogue: B/G, D/K, L, I (Depending on your country selection) Digital: DVB-T/DVB-C
Colour/Video System	Analogue: PAL, SECAM, NTSC-4.43, NTSC-3.58, PAL60 Digital: MPEG-2 MP@ML, MPEG-4, H.264/AVC MP@L3, MP@L4.0, HP@L4.0
Sound System	BG, DK, L, NICAM, MPEG1, DD, DD+, HEAAC
HDMI IN	Video: 1080 24p, 1080p, 1080i, 720p, 576p, 480p Audio: 2Ch Linear PCM 32/44.1/48kHz, 16/20/24bits.
Model Name	UE19D4005 / UE19D4015 / UE19D4025
Screen Size	19 inches
Sound (Output)	3 W X 2
Dimensions (WxDxH)	
Body	455.4 X 29.9 X 285.6 (mm)
With stand	455.4 X 144.8 X 339.5 (mm)
Weight	
Without Stand	3.1 kg
With Stand	3.4 kg

 Design and specifications are subject to change without prior notice.

 For information about power supply, and more about power consumption, refer to the label attached to the product.