



User Guide



HP Neverstop Laser 1000 series

Copyright and License

© Copyright 2019 HP Development Company, L.P.

Reproduction, adaptation, or translation without prior written permission is prohibited, except as allowed under the copyright laws.

The information contained herein is subject to change without notice.

The only warranties for HP products and services are set forth in the express warranty statements accompanying such products and services. Nothing herein should be construed as constituting an additional warranty. HP shall not be liable for technical or editorial errors or omissions contained herein.

Trademark Credits

Apple and the Apple logo are trademarks of Apple Inc., registered in the U.S. and other countries.

OS X is a trademark of Apple Inc., registered in the U.S. and other countries.

AirPrint is a trademark of Apple Inc., registered in the U.S. and other countries.

iPhone is a trademark of Apple Inc., registered in the U.S. and other countries.

Microsoft® and Windows® are U.S. registered trademarks of Microsoft Corporation.

Amazon, Kindle, and all related logos are trademarks of Amazon.com, Inc. or its affiliates.

Wi-Fi and Wi-Fi Direct are registered trademarks of the Wi-Fi Alliance. (See <https://www.wi-fi.org/who-we-are/our-brands> for more details.)

Table of contents

1 Get started	1
Printer views	2
Printer front view	2
Printer back view	2
Control panel features	3
Base models	3
Wireless models	4
Use the HP Smart app to print, copy, scan, and troubleshoot	6
2 Connect your printer	7
Connect to a wireless network with a router	8
Connect your printer to a wireless network using Wi-Fi Protected Setup (WPS)	8
Connect your printer to a wireless network using HP printer software	8
Connect wirelessly without a router	10
Wireless settings	13
3 Configure your printer	15
Configure the printer using the HP Embedded Web Server (EWS) and HP Device Toolbox (Windows)	16
Accessing and Using the Embedded Web Server (EWS)	16
Opening the HP Embedded Web Server (EWS) from the software (Windows 7)	16
Opening the HP Embedded Web Server (EWS) from a web browser	16
Opening the HP Embedded Web Server (EWS) when using a Wi-Fi Direct connection ..	17
Navigating the HP Embedded Web Server	17
Configure IP network settings	19
View or change network settings	19
Rename the printer on a network	19
Manually configure IPv4 TCP/IP parameters	19
Assign or change the system password using the HP Embedded Web Server	19
Change energy-conservation settings	20
Set the Sleep/Auto Off After Inactivity setting	20
Set the Shut Down After Inactivity delay and configure the printer to use 1 watt or less of power	20

Set the Delay Shut Down setting	21
Update the firmware	22
Update the firmware using the Firmware Update Utility	22
Change the printer connection type (Windows 7)	23
4 Load media	25
Configure the input tray for different paper sizes	25
Load paper	27
Load and print envelopes	30
Load and print labels	32
5 Print	35
Print using a Windows computer	36
Select the paper type (Windows)	36
Manually print on both sides (Windows)	37
Print multiple pages per sheet (Windows)	37
Print using a Mac computer	38
Print with mobile devices	39
6 Manage toner, media, and parts	41
Check the toner level	42
Reload toner	43
Replace the imaging drum	46
Order supplies, media, and parts	48
7 Solve problems	49
HP support	50
Contact HP	50
Register printer	50
Additional warranty options	50
Additional information	51
Interpret control-panel light patterns	52
Restore the factory-set defaults	55
Printer does not pick up paper or misfeeds	56
Introduction	56
The product does not pick up paper	56
The product picks up multiple sheets of paper	56
Clear paper jams	57
Introduction	57
Jam locations	57

Frequent or recurring paper jams	58
Clear jams from the input tray	59
Clear jams from inside the product	61
Clear jams from the output areas	62
Improve print quality	63
Introduction	63
Reprint the document	63
Check the toner level	63
Update the printer firmware	63
Print from a different software program	63
Check the paper type and print quality settings for the print job	63
Check the paper type loaded in the printer	64
Check the paper type and print quality settings (Windows)	64
Check the paper type and print quality settings (OS X)	64
Visually inspect the imaging drum	65
Check paper and the printing environment	65
Step one: Use paper that meets HP specifications	65
Step two: Check the environment	65
Adjust Print Density	66
Resolving print quality problems	67
Solve wireless network problems	72
Introduction	72
Wireless connectivity checklist	72
Perform a wireless network diagnostic test	73
The printer does not print after the wireless configuration completes	73
The printer does not print, and the computer has a third-party firewall installed	74
The wireless connection does not work after moving the wireless router or printer	74
Cannot connect more devices to the wireless printer (Wi-Fi Direct)	74
The wireless printer loses communication when connected to a VPN	75
The network does not appear in the wireless networks list	75
The wireless network is not functioning	75
Reduce interference on a wireless network	75
Appendix A Printer specifications	77
Technical specifications	77
Supported operating systems	77
Printer dimensions	79
Power consumption, electrical specifications, and acoustic emissions	79
Operating-environment range	79
Warning icons	80
Laser Warning	81

1 Get started

- [Printer views](#)
- [Control panel features](#)
- [Use the HP Smart app to print, copy, scan, and troubleshoot](#)

Printer views

- [Printer front view](#)
- [Printer back view](#)

Printer front view

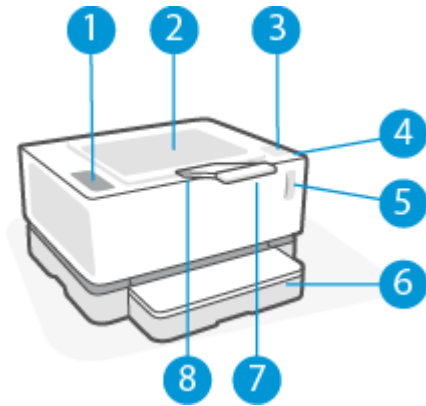

1	Control panel
2	Output bin
3	Reload port
4	Reload Status light
5	Toner level indicator
6	Input tray
7	Output bin extension
8	Finger recess

Printer back view

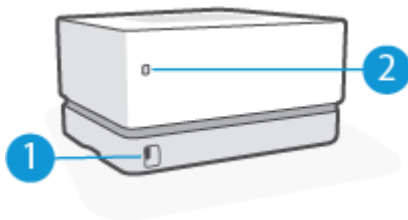





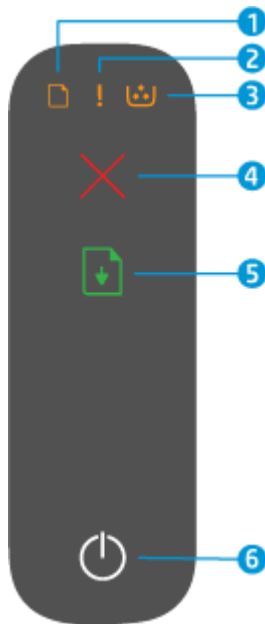

1	Power connection
2	USB port

Control panel features







Base models

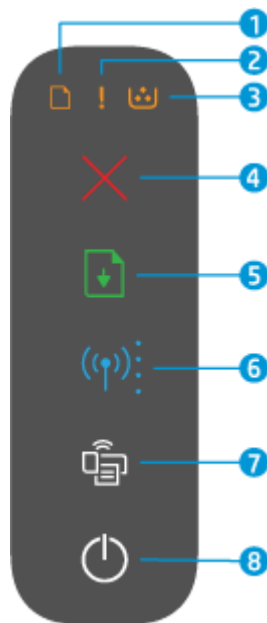



1	Paper light 	The Paper light blinks when the input tray is out of paper, and is on (solid) when there is a paper error.
2	Attention light 	The Attention light blinks when the printer requires user attention. If the Attention light is on solid, there is a service error.
3	Imaging Drum light 	When this light is on (solid), it indicates that the imaging drum is nearing the end of its useful life, or, if the Attention light is blinking at the same time, that there is a problem with the imaging drum. If the Imaging Drum light blinks, you must replace the imaging drum to continue printing.
4	Cancel button 	Press this button to cancel a job.
5	Resume button 	Press this button for the following actions: <ul style="list-style-type: none">• If the printer is in a error or prompt state, with the Resume light on, press the button to clear the error and resume printing.• In manual duplex mode, press this button to print the second side of the document.• Press and hold this button for 3 seconds to print a configuration page.
6	Power button/Ready light 	Use this button to turn the printer on or off. The Ready light is on when the printer is ready to print. It blinks when the printer is receiving print data and dims when the printer is in a low-power state.

Wireless models



1	Paper light 	The Paper light blinks when the input tray is out of paper, and is on (solid) when there is a paper error.
2	Attention light 	The Attention light blinks when the printer requires user attention. If the Attention light is on solid, there is a service error.
3	Imaging Drum light 	When this light is on (solid), it indicates that the imaging drum is nearing the end of its useful life, or, if the Attention light is blinking at the same time, that there is a problem with the imaging drum. If the Imaging Drum light blinks, you must replace the imaging drum to continue printing.
4	Cancel button 	Press this button to cancel a job.
5	Resume button 	Press this button for the following actions: <ul style="list-style-type: none"> • If the printer is in a error or prompt state, with the Resume light on, press the button to clear the error and resume printing. • In manual duplex mode, press this button to print the second side of the document. • Press and hold this button for 3 seconds to print a configuration page.
6	Wireless button and light 	Press this button to turn the wireless feature on or off. Press and hold this button to configure a WPS connection. If the Wireless button light glows steady blue, there is a stable wireless connection. If it is blinking blue, the printer is in wireless connection setup mode or WPS configuration is in progress. If the light glows amber, the printer cannot connect to the wireless network, or there is a WPS error.

7	Wi-Fi Direct button		Press this button to turn Wi-Fi Direct on or off. Press this button to complete a Wi-Fi Direct connection if it is blinking.
8	Power button/Ready light		Use this button to turn the printer on or off. The Ready light is on when the printer is ready to print. It blinks when the printer is receiving print data and dims when the printer is in a low-power state.

Use the HP Smart app to print, copy, scan, and troubleshoot

HP Smart helps you to set up, copy, scan, print, share, and manage your HP printer. You can share documents and images through email, text messages, and popular cloud and social media services (such as iCloud, Google Drive, Dropbox, and Facebook). You can also set up new HP printers, as well as monitor and order supplies.

The HP Smart app is compatible with the following mobile device and computer operating systems:

- iOS
- Android
- Windows 10
- Mac OS X 10.11 and later



NOTE: The HP Smart app might not be available in all languages. Some features might not be available with all printer models.

To install the HP Smart app

- ▲ To install the app on your device, go to 123.hp.com and follow the onscreen instructions to access your device's app store.

To open the HP Smart app on a Windows 10 computer

- ▲ After installing the HP Smart app, from the device desktop, click **Start**, and then select **HP Smart** from the app list.

Connect to your printer

- ▲ Make sure that your device is connected to the same network as the printer. Then HP Smart will automatically detect the printer.

Get more information about the HP Smart app

For more information about using HP Smart for printing, accessing printer features, and troubleshooting issues, go to:

- **iOS/Android:** www.hp.com/go/hpsmart-help
- **Windows 10:** www.hp.com/go/hpsmartwin-help
- **Mac:** <http://www.hp.com/go/hpsmartmac-help>

2 Connect your printer

The most up-to-date information for connecting your printer, and troubleshooting connection issues is available online from the HP Support sites. For example, the following topics can be found there:

- Learn more about configuring your network and the printer for wireless printing. [Click here to go online for more information.](#)
- Learn how to find your network security settings. [Click here to go online for more information.](#)
- Learn about the HP Print and Scan Doctor. [Click here to go online for more information.](#)



NOTE: This utility is only available for Windows operating system.

- Learn how to work with your firewall and antivirus programs during printer setup. [Click here to go online for more information.](#)

Connect to a wireless network with a router

 **NOTE:** This section is applicable to wireless printer models only.

Connect your printer to a wireless network using Wi-Fi Protected Setup (WPS)

Before you can connect your printer to a wireless network using WPS, make sure you have the following:

- A wireless 802.11b/g/n network that includes a WPS-enabled wireless router or access point.

 **NOTE:** The printer only supports connections using 2.4 GHz.

- A computer connected to the wireless network that you intend to connect the printer to. Be sure you have installed the HP printer software on the computer.

If you have a WPS router with a WPS push button, follow the **Push Button method**.

To use the Push Button Configuration (PBC) method

1. Press and hold the Wireless button () for at least three seconds to start WPS Push Button method.
2. Press the WPS button on your router.

 **NOTE:** The product begins a timer for approximately two minutes while a wireless connection is established.

Connect your printer to a wireless network using HP printer software

To connect the printer to an integrated wireless WLAN 802.11 network, you will need the following:

- A wireless 802.11b/g/n network that includes a wireless router or access point.

 **NOTE:** The printer only supports connections using 2.4 GHz.

- A computer connected to the wireless network that you intend to connect the printer to.
- Network name (SSID).
- WEP key or WPA Passphrase (if needed).

To connect your printer using HP printer software

1. Depending on whether you have installed the HP printer software or not, do one of the following:

If you have not installed the HP printer software on your computer

- a. Visit www.support.hp.com to download and install the printer software.
- b. Follow the onscreen instructions.

If you have the HP printer software installed on your computer

- a. Open the printer software.
- b. In the printer software, click **Tools**.

- c. Click **Device Setup & Software**.
 - d. Click **Connect a new device**, and then follow the onscreen instructions.
2. After the printer connects successfully, the Wireless button  glows blue.

Connect wirelessly without a router

 **NOTE:** This section is applicable to wireless printer models only.

With Wi-Fi Direct, you can print wirelessly from a computer, smart phone, tablet, or other wireless-capable device—without connecting to an existing wireless network.

Guidelines for using Wi-Fi Direct

- Make sure your computer or mobile device has the necessary software.
 - If you are using a computer, make sure you have installed the HP printer software.

If you have not installed the HP printer software on the computer, connect to Wi-Fi Direct first and then install the printer software. Select **Wireless** when prompted by the printer software for a connection type.
 - If you are using a mobile device, make sure you have installed a compatible printing app. For more information, visit the HP Mobile Printing website at www.hp.com/go/mobileprinting. If a local version of this website is not available in your country/region or language, you might be directed to the HP Mobile Printing website in another country/region or language.
- Make sure Wi-Fi Direct for your printer is turned on.
- Up to five computers and mobile devices can use the same Wi-Fi Direct connection.
- Wi-Fi Direct can be used regardless of whether the printer is connected to a network using a wireless connection or not.
- Wi-Fi Direct cannot be used to connect a computer, mobile device, or printer to the Internet.
- To learn more about setting up a Wi-Fi Direct connection, visit www.hp.com/go/wifidirectprinting.

To turn Wi-Fi Direct on or off from the control panel

- ▲ On the printer control panel, press the Wi-Fi Direct button .

When Wi-Fi Direct is turned on, the Wi-Fi Direct button  glows steady white.

Wi-Fi Direct connection security setting

- If the Wi-Fi Direct connection security for the printer is **Automatic**, the Wi-Fi Direct password is set to 12345678 and cannot be changed.
- If the Wi-Fi Direct connection security for the printer is set to **Manual**, you need to do one of the following to connect to the printer on your mobile device or computer.
 - If the Wi-Fi Direct button  is blinking, press it.
 - If the printer prints out a page with a PIN code, use the PIN to complete the connection to the device.

 **TIP:**

- You can also turn on Wi-Fi Direct or change the Wi-Fi Direct connection security setting from the EWS.
 - To find the Wi-Fi Direct name and password, press and hold the Resume button  on the printer for 3 seconds to print a Configuration Report.
-

To print from a wireless-capable mobile device that supports Wi-Fi Direct

 **NOTE:** Available wireless connection methods vary depending on the operating system of your mobile device. For more information, visit www.hp.com/go/wifidirectprinting.

Make sure you have installed the latest version of HP Print Service Plugin on your mobile device (if using an Android device). You can download this plugin from the Google Play application store.

1. Make sure you have turned on Wi-Fi Direct on the printer.
2. Turn on Wi-Fi Direct on your mobile device. For more information, see the documentation provided with the mobile device.
3. From your mobile device, select a document from a print enabled application, and then select the option to print the document.

The list of available printers appears.

4. From the list of available printers, choose the Wi-Fi Direct name.
5. Print your document.

To print from a wireless-capable mobile device that does not support Wi-Fi Direct

 **NOTE:** Available wireless connection methods vary depending on the operating system of your mobile device. For more information, visit www.hp.com/go/wifidirectprinting.

Make sure you have installed a compatible printing app on your mobile device. For more information, visit the HP Mobile Printing website at www.hp.com/go/mobileprinting. If a local version of this website is not available in your country/region or language, you might be directed to the HP Mobile Printing website in another country/region or language.

1. Make sure you have turned on Wi-Fi Direct on the printer.
2. Turn on the Wi-Fi connection on your mobile device. For more information, see the documentation provided with the mobile device.

 **NOTE:** If your mobile device does not support Wi-Fi, you are not able to use Wi-Fi Direct.

3. From the mobile device, connect to a new network. Use the process you normally use to connect to a new wireless network or hotspot. Choose the Wi-Fi Direct name from the list of wireless networks shown. The network name is based on the name of your printer.

Enter the Wi-Fi Direct password when prompted.

4. Print your document.

To print from a wireless-capable computer

1. Make sure you have turned on Wi-Fi Direct on the printer.
2. Turn on the computer's Wi-Fi connection. For more information, see the documentation provided with the computer.



NOTE: If your computer does not support Wi-Fi, you are not able to use Wi-Fi Direct.

3. From the computer, connect to a new network. Use the process you normally use to connect to a new wireless network or hotspot. Choose the Wi-Fi Direct name from the list of wireless networks shown. The network name is based on the name of your printer.

Enter the Wi-Fi Direct password when prompted.



4. Print your document.

Wireless settings



You can set up and manage your printer wireless connection. This includes printing information about network settings, turning the wireless function on or off, and restoring wireless settings.

To turn on or off the wireless capability of the printer

Press the Wireless button  to turn on or off the printer wireless capabilities.

- If the printer has an active connection to a wireless network, the Wireless button  is blue.
- If wireless is turned off, the Wireless button  will not be lit.

To restore network settings to default settings

- Press and hold the Wireless button  and the Cancel button  at the same time for at least three seconds. The printer restarts and then the Wireless light  starts blinking blue, indicating the printer is in Auto Wireless Connect (AWC) setup mode. You can now set up a wireless connection between the printer and your device.

3 Configure your printer

- [Configure the printer using the HP Embedded Web Server \(EWS\) and HP Device Toolbox \(Windows\)](#)
- [Update the firmware](#)
- [Change the printer connection type \(Windows 7\)](#)

Configure the printer using the HP Embedded Web Server (EWS) and HP Device Toolbox (Windows)

Use the HP Embedded Web Server to manage printing functions from your computer.

- View printer status information
- Determine the remaining life for all supplies and order new ones
- Receive notification of printer and supplies events
- View and change network configuration

The HP Embedded Web Server works when the printer is connected to your computer via an IP-based network or USB. The HP Embedded Web Server does not support IPX-based printer connections. You do not have to have Internet access to open and use the HP Embedded Web Server.

When the printer is connected to the network, you can connect to the HP Embedded Web Server directly, and it is automatically available.

When the printer is connected via USB (not connected to the network) you use the HP Device Toolbox software to connect to the HP Embedded Web Server.

 **NOTE:** If the printer is connected to a Windows computer via USB, you must use the HP Device Toolbox software application to connect to the HP Embedded Web Server (EWS). HP Device Toolbox is available only if you installed the full printer software. Depending on how the printer is connected, some features might not be available. If the printer is connected to a Windows computer via a network, or to a Mac computer, additional software is not needed to connect to the EWS.

 **NOTE:** The HP Embedded Web Server is not accessible beyond the network firewall.

Accessing and Using the Embedded Web Server (EWS)

The following sections provide instructions for accessing and navigating the HP Embedded Web Server.

Opening the HP Embedded Web Server (EWS) from the software (Windows 7)

 **NOTE:** HP Printer Assistant is part of the HP printer software for Windows 7 operating systems. Visit the [product support site](#) to find the software available for your printer and operating system.



1. Open the HP Printer Assistant.

From the computer desktop, click **Start**, select **All Programs**, click **HP**, click the folder for the printer, and then select the printer name.

2. In the HP Printer Assistant, select **Print**, and then select **HP Device Toolbox**.

Opening the HP Embedded Web Server (EWS) from a web browser

The following requires a network connection.

1. Print a configuration page to determine the IP address or host name.
 - a. Press and hold the Resume button  for three seconds.
 - b. Release the Resume button .

2. Open a web browser, and in the address line, type the IP address or host name exactly as it displays on the printer configuration page. Press the Enter key on the computer keyboard. The EWS opens.

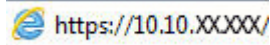

 **NOTE:** If the web browser displays a message indicating that accessing the website might not be safe, select the option to continue to the website. Accessing this website will not harm the computer.

Opening the HP Embedded Web Server (EWS) when using a Wi-Fi Direct connection

1. Set up a Wi-Fi Direct connection between your device and the printer.
2. Open a web browser, type the IP address 192.168.223.1 in the address line, and press the Enter key. The EWS opens.

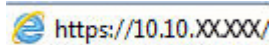

 **NOTE:** If the web browser displays a message indicating that accessing the website might not be safe, select the option to continue to the website. Accessing this website will not harm the computer.

Navigating the HP Embedded Web Server

The table below provides a summary of the features available through the HP Embedded Web Server.

Table 3-1 HP Embedded Web Server Options

Tab or section	Description
Home tab Provides printer, status, and configuration information.	<ul style="list-style-type: none"> • Device Status: Shows the printer status and shows the approximate percent life remaining of HP supplies. • Supplies Status: Shows the approximate percent life remaining of HP supplies. Actual supply life remaining can vary. Consider having a replacement supply available to install when print quality is no longer acceptable. The supply does not need to be replaced unless the print quality is no longer acceptable. • Device Configuration: Shows the information found on the printer configuration page and other device configuration settings. • Network Summary: Shows the information found on the printer network configuration page and other network configuration settings. • Event Log: Shows a list of all printer events and errors. • Open Source Licenses: Shows a summary of the licenses for open source software programs that can be used with the printer.

Table 3-1 HP Embedded Web Server Options (continued)

Tab or section	Description
<p>System tab</p> <p>Provides the ability to configure the printer from your computer.</p>	<ul style="list-style-type: none">• Device Information: Provides basic printer and company information.• Paper Setup: Change the default paper-handling settings for the printer.• Energy Settings: Change the default times for entering Sleep/Auto Off mode or automatic shut down.• System Setup: Change the system defaults for the printer.• Service: Make adjustments for environmental factors such as humidity and altitude, control archive print mode, change the USB speed, and restore factory default settings.• Administration: Set or change the printer password, enable or disable PjL device access commands, specify signature check preference for firmware updates. <p>NOTE: The System tab can be password-protected. If this printer is on a network, always consult with the administrator before changing settings on this tab.</p>
<p>Networking tab</p> <p>(Wireless models only)</p> <p>Provides the ability to change network settings from your computer or mobile device.</p>	<p>Network administrators can use this tab to control network-related settings for the printer when it is connected to an IP-based network. It also allows the network administrator to set up Wireless Direct and Google Cloud Print functionality.</p> <p>NOTE: The Network tab can be password-protected. If this printer is on a network, always consult with the administrator before changing settings on this tab.</p>

Configure IP network settings

Use the following sections to configure the printer network settings.

View or change network settings

Use the HP Embedded Web Server to view or change IP configuration settings.

1. Open the HP Embedded Web Server (EWS).
2. Click the **Networking** tab to obtain network information. Change settings as needed.

Rename the printer on a network

To rename the printer on a network so that it can be uniquely identified, use the HP Embedded Web Server.

1. Open the HP Embedded Web Server (EWS).
2. Open the **System** tab.
3. On the **Device Information** page, the default printer name is in the **Device Description** field. You can change this name to uniquely identify this printer.



NOTE: Completing the other fields on this page is optional.

4. Click the **Apply** button to save the changes.

Manually configure IPv4 TCP/IP parameters

Use the EWS to manually set an IPv4 address, subnet mask, and default gateway.

1. Open the HP Embedded Web Server (EWS).
2. On the **Networking** tab, click **IPv4 Configuration** in the left navigation pane.
3. From the **IP Preferred Address Method** drop-down, select **Manual**, and then edit the IPv4 configuration settings.
4. Click the **Apply** button.

Assign or change the system password using the HP Embedded Web Server

Assign an administrator password for access to the printer and the HP Embedded Web Server so that unauthorized users cannot change the printer settings.

1. Open the HP Embedded Web Server (EWS).
2. On the **System** tab, click the **Administration** link in the left navigation pane.
3. In the area labeled **Product Security**, enter the password in the **Password** field.
4. Re-enter the password in the **Confirm Password** field.
5. Click the **Apply** button.



NOTE: Make note of the password and store it in a safe place.

Change energy-conservation settings

The printer includes several economy features to conserve energy and supplies.

Set the Sleep/Auto Off After Inactivity setting

Use the EWS to set the amount of idle time before the printer enters sleep mode.

Complete the following procedure to change the Sleep/Auto Off After Inactivity setting:

1. Open the HP Embedded Web Server (EWS).
 - Use the HP Smart app to access the EWS, if available.
 - Use the HP Printer Assistant for Windows 7 systems.
 - Press and hold the Resume button  to print a configuration page, then navigate to the IP address shown on the printer configuration page.

 <https://10.10.XX.XXX/>

 **NOTE:** If you receive a message indicating that accessing the website might not be safe, select the option to continue to the website. Accessing this website will not harm the computer.

2. Click the **System** tab, and then select **Energy Settings**.
3. From the **Sleep/Auto Off After Inactivity** drop-down, select the time for the delay.
4. Click the **Apply** button.

Set the Shut Down After Inactivity delay and configure the printer to use 1 watt or less of power

Use the EWS to set the amount of time before the printer shuts down.

 **NOTE:** After the printer shuts down, the power consumption is 1 watt or less.

Complete the following procedure to change the Shut Down After Inactivity setting:

1. Open the HP Embedded Web Server (EWS).
 - Use the HP Smart app to access the EWS, if available.
 - Use the HP Printer Assistant for Windows 7 systems.
 - Press and hold the Resume button  to print a configuration page, then navigate to the IP address shown on the printer configuration page.

 <https://10.10.XX.XXX/>

 **NOTE:** If you receive a message indicating that accessing the website might not be safe, select the option to continue to the website. Accessing this website will not harm the computer.

2. Click the **System** tab, and then select **Energy Settings**.
3. From the **Shut Down After Inactivity** drop-down, select the time for the delay.

 **NOTE:** The default value is **4 hours**.

4. Click the **Apply** button.

Set the Delay Shut Down setting

Use the EWS to select whether or not the printer delays shutting down after the Power button  is pressed.

Complete the following procedure to change the Delay Shut Down setting:

1. Open the HP Embedded Web Server (EWS).
 - Use the HP Smart app to access the EWS, if available.
 - Use the HP Printer Assistant for Windows 7 systems.
 - Press and hold the Resume button  to print a configuration page, then navigate to the IP address shown on the printer configuration page.

 <https://10.10.XXXXX/>

 **NOTE:** If you receive a message indicating that accessing the website might not be safe, select the option to continue to the website. Accessing this website will not harm the computer.

2. Click the **System** tab, and then select **Energy Settings**.
3. Select or clear the **Delay when ports are active** option.

 **NOTE:** When this option is selected the printer will not shut down unless all ports are inactive. An active network link will prevent the printer from shutting down.

Update the firmware

HP offers periodic printer updates. Follow these steps to update the printer firmware for a single printer.

Update the firmware using the Firmware Update Utility

Use these steps to manually download and install the Firmware Update Utility from HP.com.

 **NOTE:** This method is the only firmware update option available for printers connected to the computer via a USB cable. It also works for printers connected to a network.

 **NOTE:** You must have a print driver installed in order to use this method.

1. Go to www.hp.com/go/support, select your country/region or language, and then click the **Software and Drivers** link.
2. Type the printer name in the search field, press the Enter button, and then select the printer from the list of search results.
3. Select the operating system.
4. Under the **Firmware** section, locate the **Firmware Update Utility**.
5. Click **Download**, click **Run**, and then click **Run** again.
6. When the utility launches, select the printer from the drop-down list, and then click **Send Firmware**.

 **NOTE:** To print a configuration page to verify the installed firmware version before or after the update process, click **Print Config**.

7. Follow the on-screen instructions to complete the installation, and then click the **Exit** button to close the utility.

Change the printer connection type (Windows 7)

 **NOTE:** This section is applicable to wireless printer models only.

If you have been using the printer on a USB (cable) connection, and you are using HP Printer Assistant software, you can change the connection type to a wireless connection.

 **NOTE:** HP Printer assistant is part of the HP printer software for Windows 7 operating systems. Visit the [product support site](#) to find the software available for your printer and operating system.

1. Open the HP Printer Assistant.
 - From the computer desktop, click **Start**, select **All Programs**, click **HP**, click the folder for the printer, and then select the printer name.
2. In the HP Printer Assistant, select **Tools** from the navigation bar, and then select **Device Setup & Software**.

4 Load media

- [Configure the input tray for different paper sizes](#)
- [Load paper](#)
- [Load and print envelopes](#)
- [Load and print labels](#)

Configure the input tray for different paper sizes

 **NOTE:** This section is applicable only to printer models that support Legal and Oficio paper sizes.

Some printer models support Legal and Oficio paper sizes. If your printer model supports these paper sizes, you will need to change the orientation of the paper-length guide when you switch between large and small paper sizes.

To determine if your printer supports Legal/Oficio paper, compare the paper-length guide on your printer to the following images.

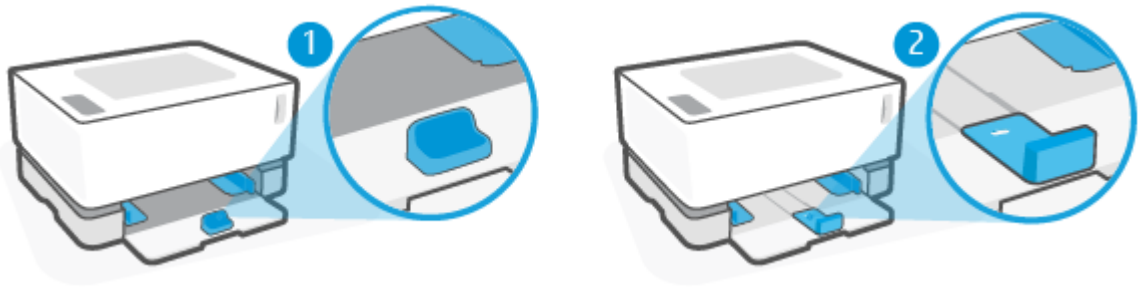

1	Printer does not support Legal/ Oficio paper.
2	Printer supports Legal/ Oficio paper.

Paper-guide orientation

- To load A4/Letter or larger paper, envelopes or labels, the paper-length guide must be in this orientation:

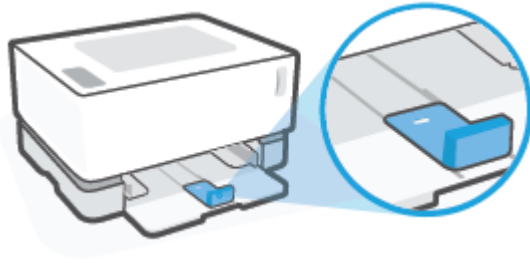

- To load paper smaller than A4/Letter, the paper-length guide must be in this orientation:

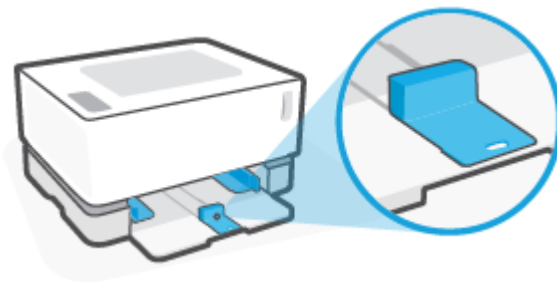

To turn the paper-length guide

1. Remove the input tray cover, if needed.

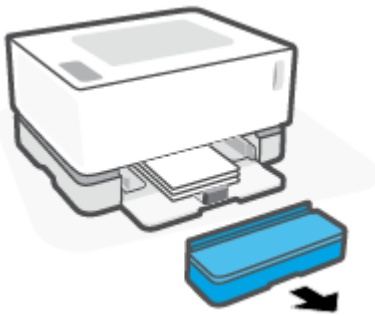

2. Remove all paper from the input tray.
3. Slide the paper-length guide to the outside edge of the input tray.

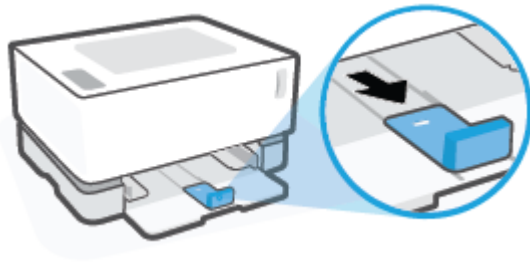

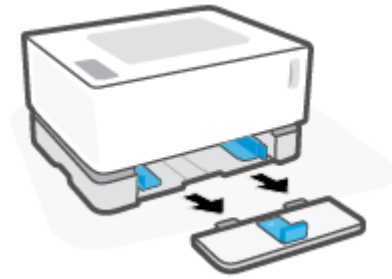

 **NOTE:** The guide is shown here in the correct orientation for A4/Letter or larger paper.

4. Remove the input tray.

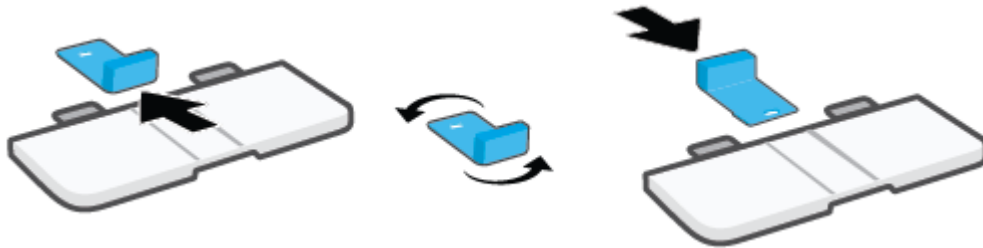

5. Slide the paper-length guide off the input tray, turn it around, and then slide it back onto the track in the tray.



 **NOTE:** The guide is shown being turned for loading paper smaller than A4/Letter. To load larger paper, turn the guide in the opposite direction.

6. Reinstall the input tray.

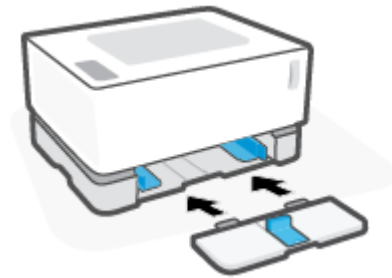

Load paper

The following information describes how to load paper into the input tray.

 **NOTE:** To avoid paper jams:

- Never add or remove paper from the input tray during printing.
- Before loading the input tray, remove all of the paper from the input tray and straighten the stack.
- Use paper that is not wrinkled, folded, or damaged.

To load paper

1. Remove the input tray cover.

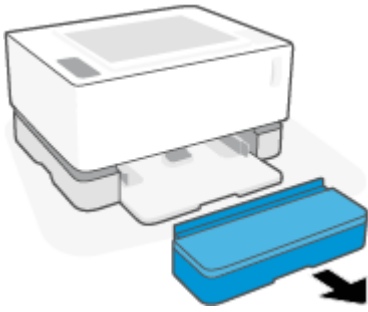

2. Remove paper from the input tray, if any.
3. Check that the paper-length guide is in the proper orientation for the paper size you are loading. For more information, see [Configure the input tray for different paper sizes on page 25](#).
4. Slide the paper guides outward to make room for the paper.

 **NOTE:** For Legal size paper, extend the paper-length guide off the edge of the tray and check that “LGL” shows in the window.

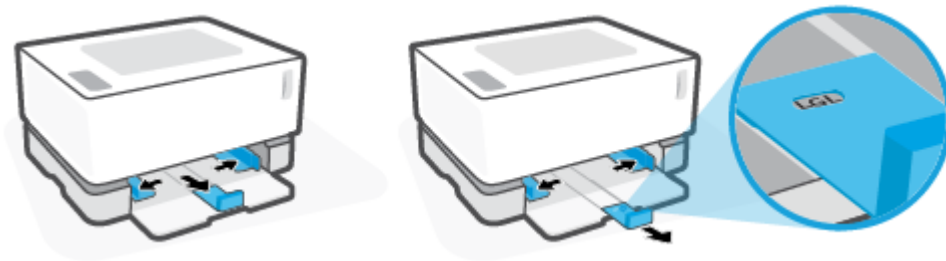

 **NOTE:** The paper-length guide is shown here in the proper orientation for A4/Letter or larger paper. To load smaller paper, the guide must be turned in the opposite direction. For more information, see [Configure the input tray for different paper sizes on page 25](#).

5. Flex or fan the edge of the paper stack to separate the pages before loading.

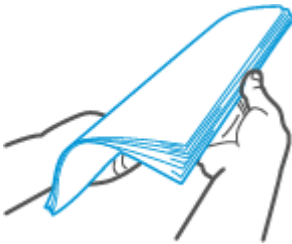

6. Insert the stack of paper into the input tray with the top forward and the side to be printed on facing up. Push the paper all the way in until it contacts the rear stop.

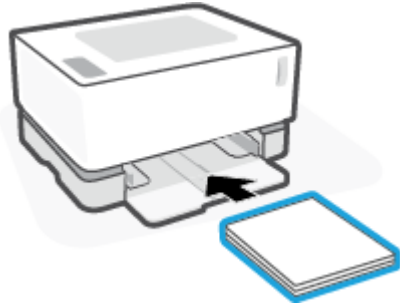

7. Slide the paper guides to the edges of the paper stack until they stop.

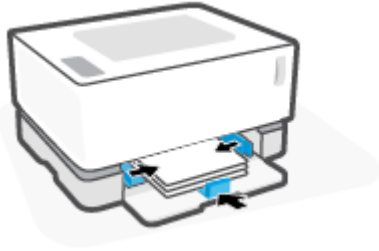

8. Replace the input tray cover.

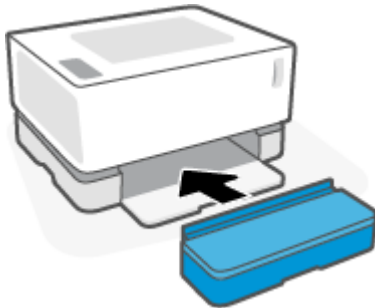

 **NOTE:** The cover cannot be used when paper larger than A4/Letter is loaded.

Load and print envelopes

To load envelopes

1. Remove the input tray cover.

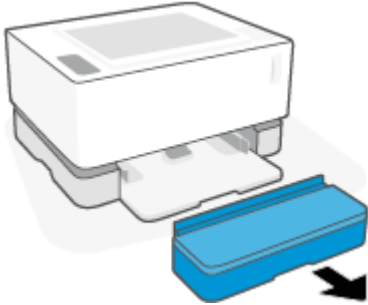

2. Slide the paper guides to the edges of the input tray.

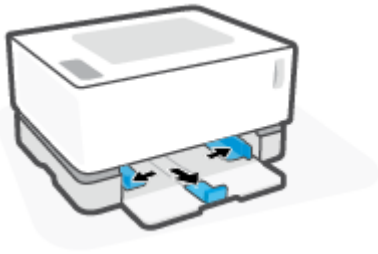

3. Remove all paper from the input tray.
4. Check that the paper-length guide is in the proper orientation for loading envelopes. For more information, see [Configure the input tray for different paper sizes on page 25](#).
5. Insert the envelope into the middle of the input tray, with the short, postage end toward the back of the tray. The side to be printed on should face up.
6. Slide the paper guides to the edges of the envelope until they stop.

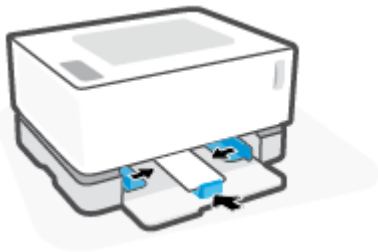

7. Replace the input tray cover.

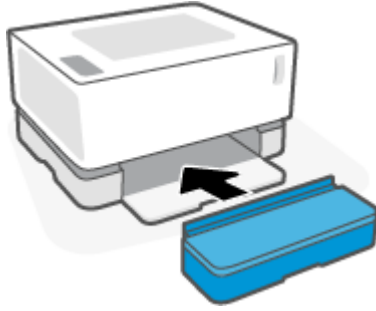

To print envelopes

1. From the software program, select the **Print** option.
2. Select the printer from the list of printers.
3. Click the button that opens the Properties dialog box. Depending on your software application, this button might be called **Properties**, **Preferences**, **Options**, **Printer Setup**, **Printer Properties**, or **Printer**.
4. Click or tap the **Paper/Quality** tab.
5. In the **Media** drop-down list, select **Envelope**.
6. Click the **OK** button to close the **Document Properties** dialog box.
7. In the **Print** dialog box, click the **OK** button to print the job.

Load and print labels

To load labels

1. Remove the input tray cover.

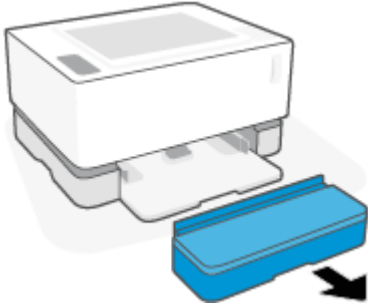

2. Slide the paper guides to the edges of the input tray.

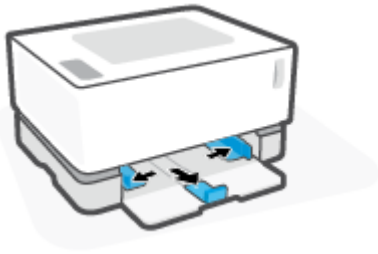

3. Remove all paper from the input tray.
4. Check that the paper-length guide is in the proper orientation for loading labels. For more information, see [Configure the input tray for different paper sizes on page 25](#).
5. Insert the sheet of labels into the middle of the input tray, with the top edge of the sheet toward the back of the tray. The side to be printed on should face up.



6. Slide the paper guides to the edges of the sheet until they stop.

7. Replace the input tray cover.

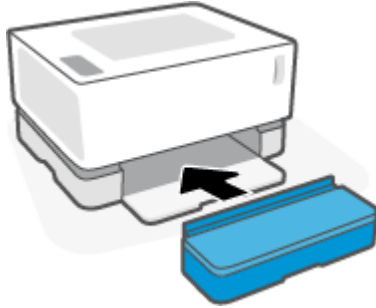

To print labels

1. From the software program, select the **Print** option.
2. Select the printer from the list of printers.
3. Click the button that opens the Properties dialog box. Depending on your software application, this button might be called **Properties**, **Preferences**, **Options**, **Printer Setup**, **Printer Properties**, or **Printer**.
4. Click the **Paper/Quality** tab.
5. In the **Media** drop-down list, select **Labels**.
6. Click the **OK** button to close the **Document Properties** dialog box.
7. In the **Print** dialog box, click the **OK** button to print the job.

5 Print

- [Print using a Windows computer](#)
- [Print using a Mac computer](#)
- [Print with mobile devices](#)



NOTE: When the Power light  is blinking and all other control panel lights are off, the printer is initializing, cooling down, performing automatic cleaning routines, or shutting down. When the printer is cooling down, print jobs might pause. Print jobs will continue when the engine is ready. This might take several minutes.

To provide productive printing, this printer may automatically enter cool down mode under certain environmental conditions when required.

Print using a Windows computer

The following procedure describes the basic printing process for Windows.

1. For wireless printing, make sure your printer is connected to the same network as your computer or device. If you want to print without connecting to a router, use Wi-Fi Direct.
2. From the software program, select the **Print** option.
3. Select the printer from the list of printers.
4. Click the button that opens the **Properties** dialog box.

Depending on your software application, this button might be called **Properties, Options, Printer Setup, Printer Properties, Printer, or Preferences.**

5. Click or tap the tabs in the print driver to configure the available options.
6. Click or tap the **OK** button to return to the **Print** dialog box. Select the number of copies to print from this screen.
7. Click or tap the **OK** button to print the job.

Select the paper type (Windows)

1. From the software program, select the **Print** option.
2. Select the printer from the list of printers.
3. Click the button that opens the **Properties** dialog box.

Depending on your software application, this button might be called **Properties, Options, Printer Setup, Printer Properties, Printer, or Preferences.**

4. Click or tap the **Printing Shortcuts** tab.
5. From the **Paper Type** drop-down list, select the correct paper type, and then click or tap the **OK** button to close the **Properties** or **Preferences** dialog box.
6. In the **Print** dialog box, click the **OK** button to print the job.

Manually print on both sides (Windows)

1. From the software program, select the **Print** option.
2. Select the printer from the list of printers.
3. Click the button that opens the **Properties** dialog box.

Depending on your software application, this button might be called **Properties, Options, Printer Setup, Printer Properties, Printer, or Preferences.**

4. Click the **Layout** tab.
5. Select the appropriate duplex option from the **Print on Both Sides Manually** drop-down list, and then click the **OK** button.
6. In the **Print** dialog box, click the **OK** button to print the job. The printer will print the first side of all the pages in the document first.
7. Retrieve the printed stack from the output bin, and place it with the printed-side facing down, top edge first in the input tray.
8. At the computer, click the **OK** button to print the second side of the job.
9. If prompted, select the appropriate control panel button to continue.

Print multiple pages per sheet (Windows)

1. From the software program, select the **Print** option.
2. Select the printer from the list of printers.
3. Click the button that opens the **Properties** dialog box.

Depending on your software application, this button might be called **Properties, Options, Printer Setup, Printer Properties, Printer, or Preferences.**

4. Click or tap the **Layout** tab.
5. Select the correct **Orientation** option.
6. Select the number of pages you want to print on each sheet from the **Pages per Sheet** option.
7. **Windows 7 only:** Click or tap the **Advanced** button.
8. Select how you want the pages to be arranged on each sheet from the **Pages per Sheet Layout** option.
9. **Windows 7 only:** Click or tap the **OK** button to close the **Advanced Options** dialog box.
10. Click or tap the **OK** button to close the **Properties** or **Preferences** dialog box.

Print using a Mac computer

Instructions for HP AirPrint-compatible printers and Mac computers with macOS and OS X 10.7 (Lion) and later.

You can print from a Mac computer that is running AirPrint as long as the printer is connected to the computer through a Wi-Fi network connection. When you use AirPrint, you do not need to download a driver to your computer.

To connect the printer

1. Connect the printer and the computer:
 - For wireless printing, verify that the printer has a good wireless connection and is connected to the same network as the computer.
 - For USB-connected printers, connect the printer to the computer via USB cable.
2. Open **System Preferences** on the computer, and select **Printers and Scanners**.
3. Click **(+)** and choose the printer from the displayed list of printers, and then click **Add**.

To print

- ▲ Once connected, use the Print command from your application or program to display the printing options. Select your printer from the list of printers available for your computer and applications. Refer to the documentation or help provided with your application for additional information.

To monitor supply levels

- ▲ Go to 123.hp.com to download and install additional applications compatible with your printer, including utilities you can use to monitor supply levels.

Print with mobile devices

 **NOTE:** This section is applicable to wireless printer models only.

You can print documents and photos directly from your mobile devices, including iOS, Android, Windows Mobile, Chromebook and Amazon Kindle.

 **NOTE:** You can also use the HP Smart app to print from mobile devices.

1. Make sure your printer is connected to the same network as your mobile device. If you want to print without connecting to a router, use Wi-Fi Direct to print from a mobile device.

2. Enable printing on your mobile device:

- **iOS:** Use the **Print** option from the **Share** menu.

 **NOTE:** Devices running iOS 4.2 or later have AirPrint preinstalled.

- **Android:** Download the HP Print Service Plugin (supported by most Android devices) from the Google Play Store and enable it on your device.

 **NOTE:** Devices running Android 4.4 or later are supported by the HP Print Service Plugin. Devices running Android 4.3 or earlier can print using the HP ePrint app, available in the Google Play Store.

- **Windows Mobile:** Tap **Print** from the **Device** menu.

 **NOTE:** If your printer is not listed, you might need to do a one-time setup of the printer using the **Add Printer** wizard.

- **Chromebook:** Download and install the **HP Print for Chrome** app from the Chrome Web Store to enable Wi-Fi printing.
- **Amazon Kindle Fire HD9 and HDX:** The first time you select **Print** on your device, the HP Print Service Plugin is automatically downloaded to enable mobile printing.

 **NOTE:** For detailed information about enabling printing from your mobile devices, visit the HP Mobile Printing website (www.hp.com/go/mobileprinting). If a local version of this website is not available in your country/region or language, you might be directed to the HP Mobile Printing website in another country/region or language.

3. Make sure the loaded paper matches the paper settings of the printer. Accurately setting the paper size for the paper that is loaded enables your mobile device to know what paper size it is printing.

6 Manage toner, media, and parts

- [Check the toner level](#)
- [Reload toner](#)
- [Replace the imaging drum](#)
- [Order supplies, media, and parts](#)

Check the toner level

When the toner in the printer runs low, you will need one or two HP Toner Reload Kits to add toner. You can purchase original HP Toner Reload Kits from www.hp.com/buy/supplies or your local HP reseller.

Check the toner level indicator on the front of the printer to determine when to add toner.



NOTE: Always check the Reload Status light  next to the reload port to determine whether or not toner can be added.

Toner can be added when the Reload Status light  next to the reload port glows white. Toner cannot be added when the light is off. If the light is off, there may still be too much toner to accept a full reload, or the imaging drum may need to be replaced soon.



Full: Toner level is high and more toner cannot be added at this time.



Fill: Toner level is low. "+1" means one Toner Reload Kit can be added.



Low: Toner level is low. "+2" means two Toner Reload Kits can be added.



Very Low: Toner is depleted. Printer will not print until toner is added.

Reload toner

Use the Reload Status light  (near the reload port) and the toner level indicator (on the front of the printer) to determine when to add toner.

To reload toner

1. Verify that the Reload Status light  is on (white). Toner cannot be added when the light is off.
2. Shake the Toner Reload Kit for at least 10 seconds. You should hear the ball inside mixing the toner.



3. Remove the ring and the cap.

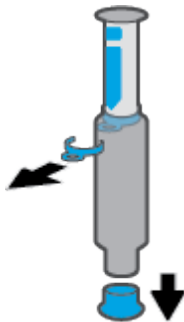

4. Uncover the reload port.

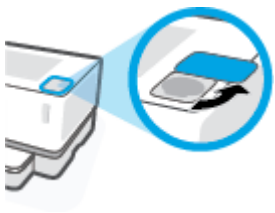

5. Insert the Toner Reload Kit into the reload port and rotate it clockwise 180° until it stops.

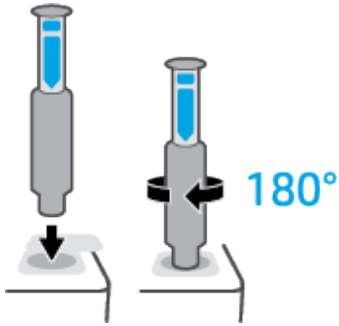

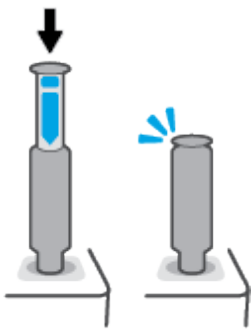

6. Push the plunger down completely until you hear a click. If the plunger does not go all the way down as shown, pull it up and push it down again until it does.

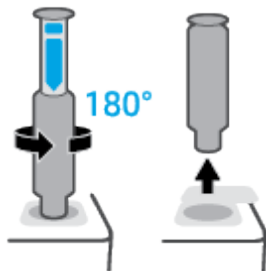

7. Rotate the Toner Reload Kit counterclockwise 180° to disengage it from the port. Remove the kit from the port and recycle it.



 **NOTE:** If you are unable to rotate the kit, the plunger is not all the way down. Repeat steps 6 and 7. If you still cannot undock the kit, press the **Cancel** button  on the control panel, remove and thoroughly shake the kit, and then try again.

8. Cover the reload port.

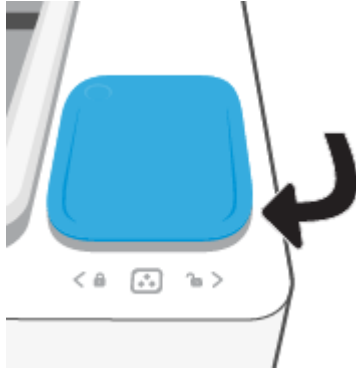

Replace the imaging drum

To replace the imaging drum

1. Lift the top cover.

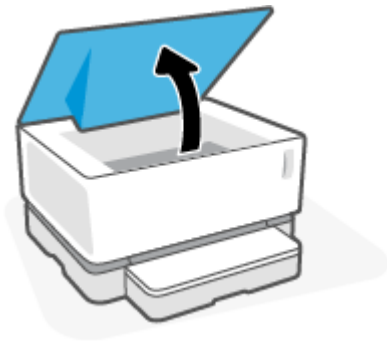

2. Remove and recycle the used imaging drum.

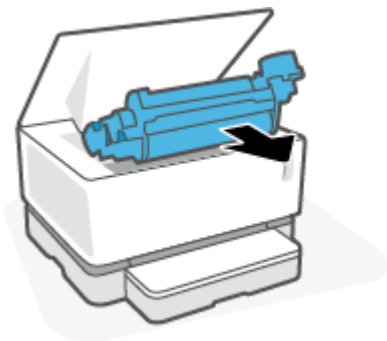

3. Remove the orange cover from the new imaging drum, while carefully pulling the two tabs out of the imaging drum as you remove the cover.

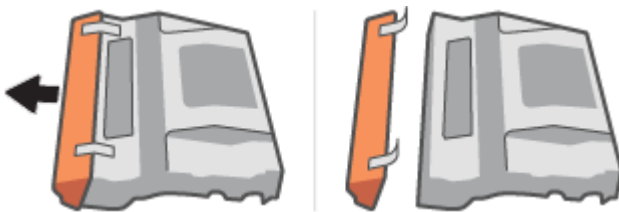

4. Shake the new imaging drum.

5. Insert the new imaging drum in the printer.

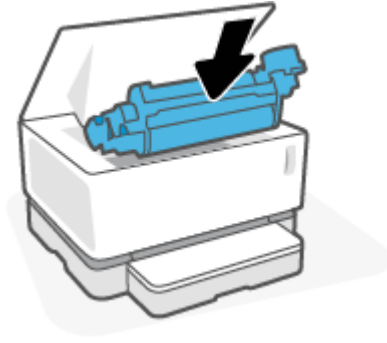

6. Lower the top cover.



Order supplies, media, and parts

Table 6-1 Ordering information

Order supplies and paper	www.hp.com/go/suresupply
Order genuine HP parts or accessories	www.hp.com/buy/parts
Order through service or support providers	Contact an HP-authorized service or support provider.
General information	www.hp.com/support/Neverstop1000
Order using the HP Embedded Web Server (EWS)	To access, in a supported Web browser on the computer, enter the printer IP address or host name in the address/URL field. The EWS contains a link to the HP SureSupply Web site, which provides options for purchasing Original HP supplies.

Table 6-2 Supplies

Item	Description
HP 103A Black Original Neverstop Laser Toner Reload Kit	One toner reload kit
HP 103AD Dual Pack Black Original Neverstop Laser Toner Reload Kit	Package of two toner reload kits.
HP 104A Black Original Laser Imaging Drum	Replacement imaging drum

7 Solve problems

- [HP support](#)
- [Interpret control-panel light patterns](#)
- [Restore the factory-set defaults](#)
- [Printer does not pick up paper or misfeeds](#)
- [Clear paper jams](#)
- [Improve print quality](#)
- [Resolving print quality problems](#)
- [Solve wireless network problems](#)

HP support

For the latest product updates and support information, visit the product support website at www.support.hp.com. HP online support provides a variety of options for help with your printer:



Get software and drivers: Download software, drivers, and firmware you need for the printer.



Ask the community: Join the community forums to find solutions, ask questions, and share tips.



HP Diagnostic Tools: Use HP online tools to detect your printer and find recommended solutions.

Contact HP

If you need help from an HP technical support representative to solve a problem, visit the [Contact Support website](#). The following contact options are available at no cost for in-warranty customers (HP agent-assisted support for out-of-warranty customers may require a fee):



Chat with an HP support agent or the HP Virtual Agent online.



Call an HP support agent.

When contacting HP support, be prepared to provide the following information:

- Product name (located on the printer)
- Product number (located on the label on the back of the printer)
- Serial number (located on the back or bottom of the printer)

Register printer

By taking just a few minutes to register, you can enjoy quicker service, more efficient support, and product support alerts. If you did not register your printer while installing the software, you can register now at <http://www.register.hp.com>.

Additional warranty options

Extended service plans are available for the printer at additional costs. Go to www.support.hp.com, select your country/region and language, then explore the extended warranty options available for your printer.

Additional information

Go to www.hp.com/support/Neverstop1000 , or go to www.hp.com/support. Select your country/region. Enter the product name, and then select **Search**

Instructions are available for performing various tasks, such as the following:

- Troubleshooting your printer
- Printing from various applications, and from various devices
- Obtaining support

You will find documents, videos, and many other resources to help you get the most from your printer.

Interpret control-panel light patterns

Table 7-1 Status-light legend



	Example symbol for "light blinking"
	Example symbol for "light on"

Table 7-2 Control-panel light patterns

















Light status	State of the printer	Action
Resume light and Cancel light are on. 	The printer is in manual-feed mode for printing envelopes or labels.	Load an envelope or sheet of labels into the input tray, and then press the Resume button  to continue. Or press the Cancel button  to cancel the current job.
	The printer is processing a manual duplex job.	Load the pages into the input tray to print the second sides, and then press the Resume button  to continue. Or press the Cancel button  to cancel the current job.
	The printer received a request for Google Cloud Print registration.	Press the Resume button  to continue or press the Cancel button  to stop.
Attention light is blinking. Paper light, Resume light, and Cancel light are on. 	The paper type or size loaded in the input tray is different than the paper type or size specified in the print job settings.	Load the paper type and size that matches the print job settings into the input tray, or press the Resume button  to continue with the currently loaded paper. Alternately, you can press the Cancel button  to cancel the current job.
Wi-Fi Direct light and Attention light are blinking. Cancel light is on. 	The printer has received a request to connect to this printer using Wi-Fi Direct.	Press the Wi-Fi Direct button  to connect or press the Cancel button  to stop.
Attention light and Paper light are blinking. 	The input tray is empty.	Load the input tray.
Attention light is blinking. 	A door is open.	Verify that the top cover is fully closed.
Attention light is blinking. Paper light, Resume light, and Cancel light are on. 	Paper is jammed in the input tray.	Clear the jam. Press the Resume button  to continue.

Table 7-2 Control-panel light patterns (continued)



















Light status	State of the printer	Action
Attention light is blinking. Paper light and Cancel light are on. 	Paper is jammed in the imaging drum area.	Clear the jam.
Toner Warning light (on the toner level indicator) is blinking (amber). Reload Status light (next to the reload port) is on (white). 	The toner level is too low for printing.	Add toner using a Toner Reload Kit.
Attention light and Imaging Drum light are blinking. 	The imaging drum has reached the end of its service life and must be replaced.	Replace the imaging drum.
Reload Status light (next to the reload port) is amber and blinking rapidly. 	There is a problem with the Toner Reload Kit.	Use a different Toner Reload Kit. You must wait until the Reload Status light  turns white before attempting to reload toner.
Attention light is blinking and Imaging Drum Light is on. 	The imaging drum is missing or incorrectly installed.	Install or reinstall the imaging drum.
	There is a problem with the imaging drum.	Use a different imaging drum.
	There is a problem reading the toner level.	Remove and shake the imaging drum, and then reinstall it.
	Imaging drum seal in place.	Remove the seal on the imaging drum.
Attention light is on. 	There is a problem detected by the imaging drum sensor.	
	There is an issue with the flatbed scanner.	Turn off the device and then turn it on. If the problem persists, contact HP support.
	Paper wrap jam.	Contact HP support. A service call is required to clear the jam without damaging the print engine.
	There is an issue with the print engine.	Turn off the device and then turn it on. If the problem persists, contact HP support.
	There is a problem with the wireless hardware.	Turn off the device and then turn it on. If the problem persists, contact HP support.
Reload Status light is amber and blinking rapidly. 	The toner level is full and the printer cannot accept additional toner at this time.	Remove the Toner Reload Kit and wait until the Reload Status light  turns white before attempting to reload toner.
	The printer cannot accept additional toner at this time either because it is busy, or the imaging drum is too close to the end of its useful life.	Remove the Toner Reload Kit and wait until the Reload Status light  turns white before attempting to reload toner.

Table 7-2 Control-panel light patterns (continued)

Light status	State of the printer	Action
	The previous Toner Reload Kit was not completely emptied into the printer.	Remove the current Toner Reload Kit, reinstall the previous Toner Reload Kit, and make sure that the toner is dispensed completely into the printer.
	There is a problem with the Toner Reload Kit in the reload port.	Use a different Toner Reload Kit to add toner. You must wait until the Reload Status light  turns white before attempting to reload toner.
Toner Warning light (on the toner level indicator) and Reload Status light (next to the reload port) are blinking amber.	There is a problem with the Toner Reload Kit docking motor.	Clear any debris from the reload port.
		
Wireless light is on (amber) and the Cancel light is blinking.	An error occurred when attempting a wireless WPS connection.	Press the Cancel button  to continue.
		
Attention light is blinking and Resume light is on.	The wireless hardware is not detected.	Press the Resume button  to continue without the wireless hardware.
		
	Incorrect firmware has been loaded.	Press the Resume button  to continue. Load the correct firmware.

Restore the factory-set defaults

Restoring the factory-set defaults returns all of the printer and network settings to the factory defaults. It will not reset the page count. To restore the printer to the factory-default settings, follow these steps.

 **CAUTION:** Restoring the factory-set defaults returns all of the settings to the factory defaults, and it also deletes any pages that are stored in the memory.

1. Open the HP Embedded Web Server (EWS). For more information, see the Accessing and Using the Embedded Web Server (EWS) section of this User Guide.
2. On the **System** tab, click **Service**.
3. In the **Restore Defaults** area, click the **Restore defaults** button.

The printer automatically restarts.

Printer does not pick up paper or misfeeds

Introduction

The following solutions can help solve problems if the printer is not picking up paper from the input tray or is picking up multiple sheets of paper at one time. Either of these situations can result in paper jams.

- [The product does not pick up paper](#)
- [The product picks up multiple sheets of paper](#)

The product does not pick up paper

If the product does not pick up paper from the input tray, try these solutions.

1. Open the product and remove any jammed sheets of paper.
2. Load the correct size of paper for your job.
3. Make sure you select the correct paper size and type when setting up the print job.
4. Make sure the paper guides in the input tray are adjusted correctly for the size of paper.
5. The rollers above the input tray might be contaminated. Clean the rollers with a lint-free cloth dampened with warm water.

The product picks up multiple sheets of paper

If the product picks up multiple sheets of paper from the input tray, try these solutions.

1. Remove the stack of paper from the input tray and flex it, rotate it 180 degrees, and flip it over. Return the stack of paper to the input tray.
2. Use only paper that meets HP specifications for this product.
3. Use paper that is not wrinkled, folded, or damaged. If necessary, use paper from a different package.
4. Make sure the input tray is not overfilled. If it is, remove the entire stack of paper from the tray, straighten the stack, and then return some of the paper to the input tray.
5. Make sure the paper guides in the tray are adjusted correctly for the size of paper.
6. Make sure the printing environment is within recommended specifications.

Clear paper jams

Introduction

The following information includes instructions for clearing paper jams from the printer.

- [Jam locations](#)
- [Frequent or recurring paper jams](#)
- [Clear jams from the input tray](#)
- [Clear jams from inside the product](#)
- [Clear jams from the output areas](#)

Jam locations

Jams can occur at the following locations in the product.

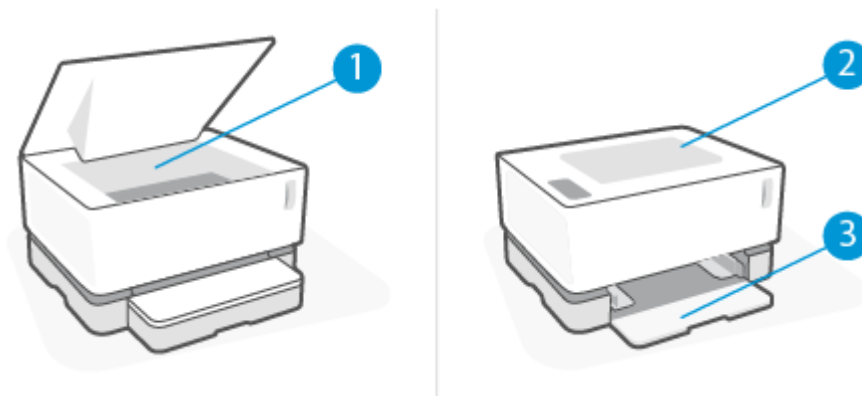



1	Internal areas
2	Output bin
3	Input tray

 **NOTE:** Jams can occur in more than one location.

Frequent or recurring paper jams

Follow these steps to solve problems with frequent paper jams. If the first step does not resolve the problem continue with the next step until you have resolved the problem.



1. If paper has jammed in the printer, clear the jam and then print a configuration page to test the printer.
2. Check that the input tray is configured for the correct paper size and type. Adjust paper settings if necessary.
 - a. Print a configuration page to determine the IP address or host name.
 - i. Press and hold the Resume  button for three seconds.
 - ii. Release the Resume  button.
 - b. Open a web browser, and in the address line, type the IP address or host name exactly as it displays on the printer configuration page. Press the Enter key on the computer keyboard. The EWS opens.

 <https://10.10.XX.XXX/>

 **NOTE:** If the web browser displays a message indicating that accessing the website might not be safe, select the option to continue to the website. Accessing this website will not harm the computer.

- c. Click the **System** tab, and then click the **Paper Setup** page.
- d. From the **Tray 1 Type** drop-down list, select the type of paper that is in the input tray.
- e. From the **Tray 1 Size** drop-down list, select the size of paper that is in the input tray.

 **NOTE:** You can also use the **Default Paper Type** and **Default Paper Size** options to change the default settings to match the paper you use most frequently.

3. Turn the printer off, wait 30 seconds, and then turn it on again.
4. Print a configuration page to test the printer.
 - a. Press and hold the Resume  button for three seconds.
 - b. Release the Resume  button.

If none of these steps resolves the problem, the printer might need service. Contact HP customer support.

Clear jams from the input tray

⚠ CAUTION: Do not use sharp objects, such as tweezers or needle-nose pliers, to remove jams. Damage caused by sharp objects will not be covered by the warranty.

When removing jammed media, pull the jammed media straight away from the product. Pulling jammed media out of the product at an angle can damage the product.

📝 NOTE: Depending on where the jam is located, some of the following steps might not be necessary.

1. Lift the top cover, and then remove the imaging drum.

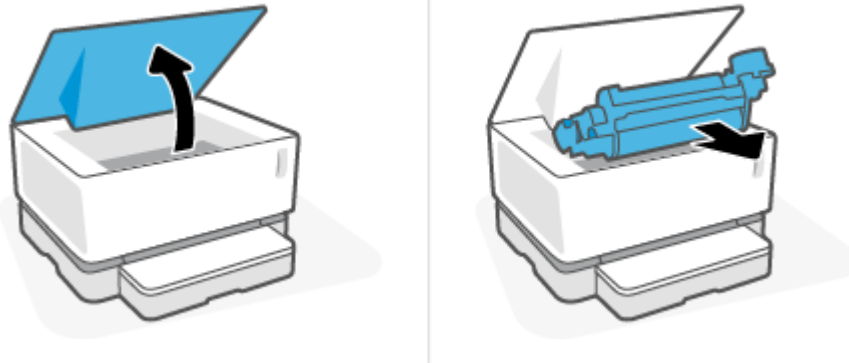

⚠ CAUTION: To prevent damage, do not expose the imaging drum to light. Cover it with a piece of paper.

2. Remove the media stack from the input tray.

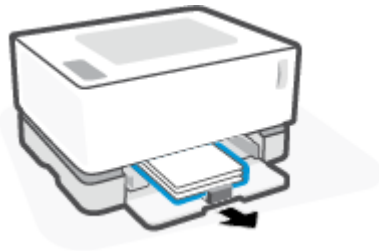

3. With both hands, grasp the side of the jammed media that is most visible (this includes the middle), and carefully pull it free from the product.



4. Reinstall the imaging drum, and then lower the top cover.

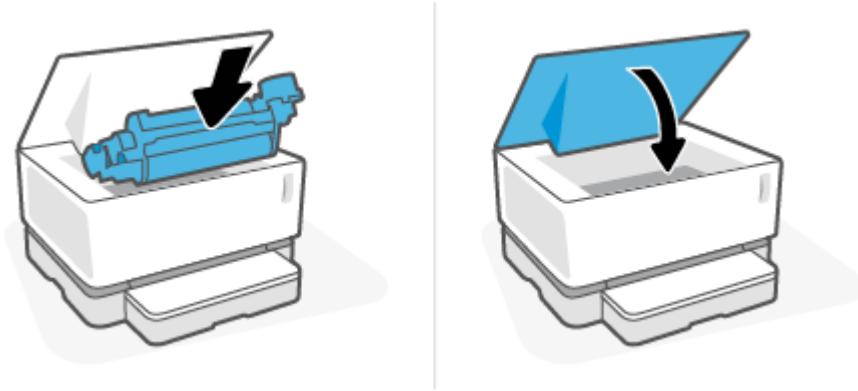

Clear jams from inside the product

⚠ CAUTION: Do not use sharp objects, such as tweezers or needle-nose pliers, to remove jams. Damage caused by sharp objects will not be covered by the warranty.

When removing jammed media, pull the jammed media straight away from the product. Pulling jammed media out of the product at an angle can damage the product.

1. Lift the top cover, and then remove the imaging drum.

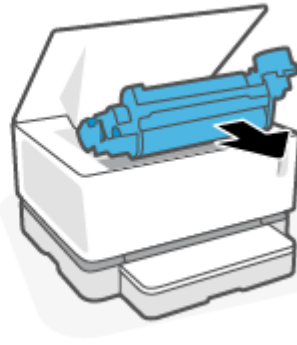

⚠ CAUTION: To prevent damage, do not expose the imaging drum to light. Cover it with a piece of paper.

2. If you can see the jammed paper, carefully grasp the jammed paper, and slowly pull it out of the product.



3. Reinstall the imaging drum, and then lower the top cover.

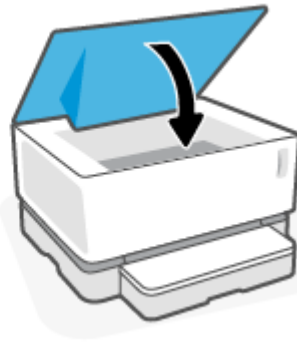
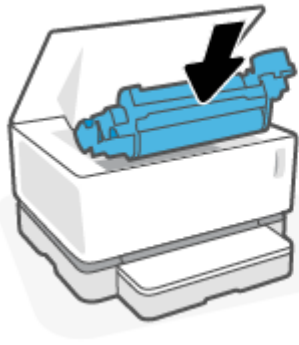

Clear jams from the output areas

⚠ CAUTION: Do not use sharp objects, such as tweezers or needle-nose pliers, to remove jams. Damage caused by sharp objects will not be covered by the warranty.

- ▲ Carefully grasp the jammed paper in the output bin area, and slowly pull it out of the product.

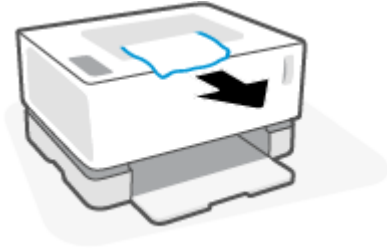

Improve print quality

- [Introduction](#)
- [Reprint the document](#)
- [Check the toner level](#)
- [Update the printer firmware](#)
- [Print from a different software program](#)
- [Check the paper type and print quality settings for the print job](#)
- [Visually inspect the imaging drum](#)
- [Check paper and the printing environment](#)
- [Adjust Print Density](#)

Introduction

Print-quality problems, such as smears, streaks, missing toner, and so on, can often be resolved using the same steps, no matter the specific symptoms. Try the following steps in the order presented as a starting point for resolving print quality issues.

For information about resolving specific image defects, see the Resolving print quality problems section of this User Guide.

Reprint the document

Reprint the document. Print quality defects can be intermittent in nature or can go away completely with continued printing.

Check the toner level

If the toner level is low, reload toner. For more information, see the Check the toner level section of this User Guide.

Update the printer firmware

Try upgrading the printer firmware. For more information, see the Update the firmware section of this User Guide.

Print from a different software program

Try printing from a different software program. If the page prints correctly, the problem is with the software program from which you were printing.

Check the paper type and print quality settings for the print job

Check the paper type and print quality settings when printing from a software program and the printed pages have smears, fuzzy or dark print, curled paper, scattered dots of toner, loose toner, or small areas of missing toner. Make sure the paper type setting matches the type of paper loaded in the printer.

Check the paper type loaded in the printer

1. Remove the input tray cover.

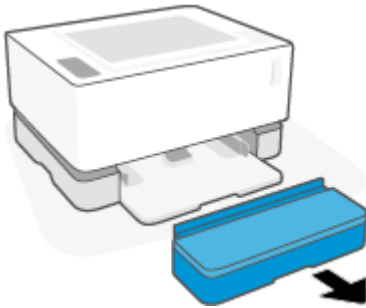

2. Verify that the input tray is loaded with the correct type of paper.
3. Replace the input tray cover.

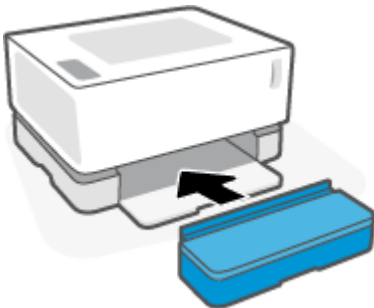

Check the paper type and print quality settings (Windows)

1. From the software program, select the **Print** option.
2. Select the printer, and then click the **Properties** or **Preferences** button.
3. Click the **Paper/Quality** tab.
4. Expand the **Paper Type** option to see the paper types that are available.
5. Select the option for the type of paper you are using.
6. From the **Print Quality** drop-down list, select an option. Select lower quality to print faster and save ink, or higher quality to obtain sharper prints.
7. Click the **OK** button to close the **Document Properties** dialog box. In the **Print** dialog box, click the **OK** button to print the job.

Check the paper type and print quality settings (OS X)

1. Click the **File** menu, and then click the **Print** option.
2. In the **Printer** menu, select the printer.
3. Choose paper type from the **Media & Quality** option..

4. Select a print quality option. Select lower quality to print faster and save ink, or higher quality to obtain sharper prints.
5. Click the **Print** button.

Visually inspect the imaging drum

Follow these steps to inspect the imaging drum.

1. Remove the imaging drum from the printer, and verify that the sealing tape has been removed.
2. Check the memory chip for damage (for example, broken edges or a scratched surface). The memory chip is located on the part of the imaging drum that is closest to the reload port when the drum is installed.
3. Examine the surface of the green roller on the imaging drum.

 **CAUTION:** Do not touch the green roller on the imaging drum. Fingerprints on this surface can cause print-quality problems.

4. If you see any scratches, fingerprints, or other damage on the imaging drum, replace the imaging drum.
5. Reinstall the imaging drum, and print a few pages to see if the problem has resolved.

Check paper and the printing environment

Step one: Use paper that meets HP specifications

Some print-quality problems arise from using paper that does not meet HP specifications.

- Make sure that the paper type, size, and weight are supported by the printer. See the printer support page at support.hp.com for a list of the supported paper sizes and types for the printer.
- Use paper that is of good quality and free of cuts, nicks, tears, spots, loose particles, dust, wrinkles, voids, staples, and curled or bent edges.
- Use paper that has not been previously printed on.
- Use paper that does not contain metallic material, such as glitter.
- Use paper that is designed for use in laser printers. Do not use paper that is designed only for use in Inkjet printers.
- Use paper that is not too rough. Using smoother paper generally results in better print quality.

If print quality issues persist on good quality paper that is within the HP specifications, and you have also tried the other recommended solutions, try using paper from a different package.

Step two: Check the environment

The environment can directly affect print quality and is a common cause for print-quality or paper-feeding issues. Try the following solutions:

- Move the printer away from drafty locations, such as open windows or doors, or air-conditioning vents.
- Make sure the printer is not exposed to temperatures or humidity outside of printer specifications.
- Do not place the printer in a confined space, such as a cabinet.

- Place the printer on a sturdy, level surface.
- Remove anything that is blocking the vents on the printer. The printer requires good air flow on all sides, including the top.
- Protect the printer from airborne debris, dust, steam, grease, or other elements that can leave residue inside the printer.

Adjust Print Density

Complete the following steps to adjust the print density.

1. Open the HP Embedded Web Server (EWS).
 - Use the HP Smart app to access the EWS, if available.
 - Use the HP Printer Assistant for Windows 7 systems.
 - Press and hold the Resume button  to print a configuration page, then navigate to the IP address shown on the printer configuration page.

 <https://10.10.XX.XXX/>



NOTE: If you receive a message indicating that accessing the website might not be safe, select the option to continue to the website. Accessing this website will not harm the computer.

2. Click the **System** tab, and then select **System Setup** from the left navigation pane.
3. Select the correct density settings.
4. Click **Apply** to save the changes.

Resolving print quality problems

The following information provides troubleshooting steps for solving specific image defect issues, including the following defects:

- Light print
- Gray background or dark print
- Blank pages
- Black pages
- Dark or light bands
- Dark or light streaks
- Missing toner
- Skewed images
- Curled paper

Find the example in this section that matches the print quality issue you are experiencing and follow the provided solution steps.

The following examples depict letter-size paper that has passed through the printer short-edge first.



NOTE: The term “fusing” refers to the part of the printing process where toner is affixed to paper.

Table 7-3 Light print

Description	Sample	Possible solutions
<p>Light print:</p> <p>The printed content on the entire page is light or faded.</p>		<ol style="list-style-type: none">1. Reprint the document.2. Remove the imaging drum, and then shake it to redistribute the toner.3. Make sure that the imaging drum is installed correctly.4. Print a configuration report and check for life and usage of the imaging drum.5. If the toner is low, reload toner.6. If the problem persists, go to support.hp.com.

Table 7-4 Gray background or dark print

Description	Sample	Possible solutions
<p>Gray background or dark print:</p> <p>The image or text is darker than expected.</p>		<ol style="list-style-type: none"> 1. Make sure that the paper in the input tray has not already been run through the printer. 2. Use a different paper type. 3. Reprint the document. 4. From the printer EWS, go to the Adjust Toner Density menu, and then adjust the toner density to a lower level. 5. Make sure that the printer is in within the supported operating temperature and humidity range. 6. If the toner is low, reload toner. 7. If the problem persists, go to support.hp.com.

Table 7-5 Blank page — No print

Description	Sample	Possible solutions
<p>Blank page — No print:</p> <p>The page is completely blank and contains no printed content.</p>		<ol style="list-style-type: none"> 1. Make sure that the imaging drum is installed correctly. 2. Check the paper type in the input tray and adjust the printer settings to match. If necessary, select a lighter paper type. 3. If the problem persists, go to support.hp.com.

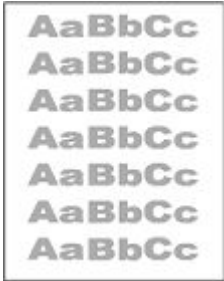
Table 7-6 Black page

Description	Sample	Possible solutions
<p>Black page:</p> <p>The entire printed page is black.</p>		<ol style="list-style-type: none"> 1. Visually inspect the imaging drum to check for damage. 2. Make sure that the imaging drum is installed correctly. 3. Replace the imaging drum. 4. If the problem persists, go to support.hp.com.

Table 7-7 Banding defects

Description	Sample	Possible solutions
<p>Repetitive wide-pitch banding and impulse bands:</p> <p>Dark or light lines which repeat down the length of the page. They might be sharp or soft in nature. The defect displays only in areas of fill, not in text or sections with no printed content.</p>		<ol style="list-style-type: none"> 1. Reprint the document. 2. If the toner is low, reload toner. 3. Use a different paper type. 4. If the problem persists, go to support.hp.com.

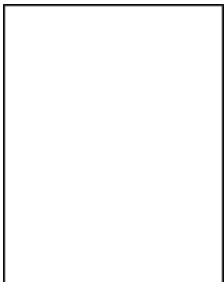
Table 7-8 Streak defects

Description	Sample	Possible solutions
<p>Light vertical streaks:</p> <p>Light streaks that usually span the length of the page. The defect displays only in areas of fill, not in text or sections with no printed content.</p>		<ol style="list-style-type: none"> 1. Reprint the document. 2. Remove the imaging drum, and then shake it to redistribute the toner. 3. If the problem persists, go to support.hp.com. <p>NOTE: Both light and dark vertical streaks can occur when the printing environment is outside the specified range for temperature or humidity. Refer to your printer's environmental specifications for allowable temperature and humidity levels.</p>
<p>Dark vertical streaks:</p> <p>Dark lines which occur down the length of the page. The defect might occur anywhere on the page, in areas of fill or in sections with no printed content.</p>		<ol style="list-style-type: none"> 1. Reprint the document. 2. Remove the imaging drum, and then shake it to redistribute the toner. 3. If the toner level is low, reload toner. 4. If the problem persists, go to support.hp.com.

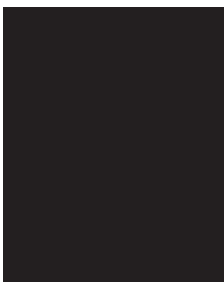
Table 7-9 Fixing/fuser defects

Description	Fixing/fuser	Possible solutions
<p>Hot fuser offset (shadow):</p> <p>Slight shadows, or offsets, of the image repeated down the page. The repeated image might fade with each recurrence.</p>		<ol style="list-style-type: none"> 1. Reprint the document. 2. Check the paper type in the input tray and adjust the printer settings to match. If necessary, select a lighter paper type. 3. If the problem persists, go to support.hp.com.
<p>Poor fusing:</p> <p>Toner rubs off along either edge of page. This defect is more common at the edges of high-coverage jobs and on light media types but can occur anywhere on the page.</p>		<ol style="list-style-type: none"> 1. Reprint the document. 2. Check the paper type in the input tray and adjust the printer settings to match. If necessary, select a heavier paper type. 3. If the problem persists, go to support.hp.com.

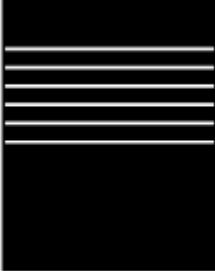
Table 7-10 Image placement defects

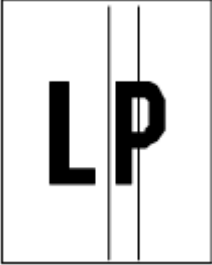

Description	Sample	Possible solutions
<p>Margins and skew:</p> <p>The image is not centered, or is skewed on the page. The defect occurs when the paper is not positioned properly as it is pulled from the input tray and moves through the paper path.</p>		<ol style="list-style-type: none"> 1. Reprint the document. 2. Remove the paper and then reload the input tray. Make sure that all the paper edges are even on all sides. 3. Make sure that the top of the paper stack is below the input tray full indicator. Do not overfill the input tray. 4. Make sure that the paper guides are adjusted to the correct size for the paper. Do not adjust the paper guides tightly against the paper stack. 5. If the problem persists, go to support.hp.com.

Table 7-11 Output defects

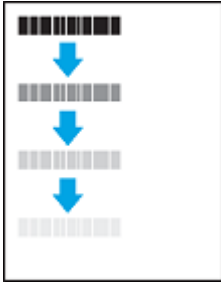
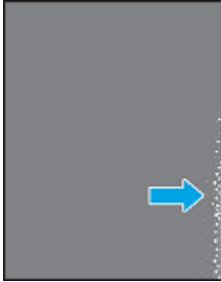
Description	Sample	Possible solutions
<p>Output curl:</p> <p>Printed paper has curled edges. The curled edge can be along the short or long side of the paper. Two types of curl are possible:</p> <ul style="list-style-type: none">• Positive curl: The paper curls toward the printed side. The defect occurs in dry environments or when printing high coverage pages.• Negative curl: The paper curls away from the printed side. The defect occurs in high-humidity environments or when printing low coverage pages.		<ol style="list-style-type: none">1. Reprint the document.2. Positive curl: From the printer EWS, select a heavier paper type. The heavier paper type creates a higher temperature for printing. Negative curl: From the printer EWS, select a lighter paper type. The lighter paper type creates a lower temperature for printing. Try storing the paper in a dry environment prior or use freshly opened paper.3. From the printer EWS, turn on the Less Paper Curl option. (Click the System tab, select Service, and then select Less Paper Curl.)4. If the problem persists, go to support.hp.com.
<p>Output stacking:</p> <p>The paper does not stack well in the output tray. The stack might be uneven, skewed, or the pages might be pushed out of the tray and onto the floor. Any of the following conditions can cause this defect:</p> <ul style="list-style-type: none">• Extreme paper curl• The paper in the tray is wrinkled or deformed• The paper is a non-standard paper type, such as envelopes• The output tray is too full		<ol style="list-style-type: none">1. Reprint the document.2. Extend the output bin extension.3. If the defect is caused by extreme paper curl, complete the troubleshooting steps for Output curl.4. Use a different paper type.5. Use freshly opened paper.6. Remove the paper from the output tray before the tray gets too full.7. If the problem persists, go to support.hp.com.

Solve wireless network problems

- [Introduction](#)
- [Wireless connectivity checklist](#)
- [Perform a wireless network diagnostic test](#)
- [The printer does not print after the wireless configuration completes](#)
- [The printer does not print, and the computer has a third-party firewall installed](#)
- [The wireless connection does not work after moving the wireless router or printer](#)
- [Cannot connect more devices to the wireless printer \(Wi-Fi Direct\)](#)
- [The wireless printer loses communication when connected to a VPN](#)
- [The network does not appear in the wireless networks list](#)
- [The wireless network is not functioning](#)
- [Reduce interference on a wireless network](#)

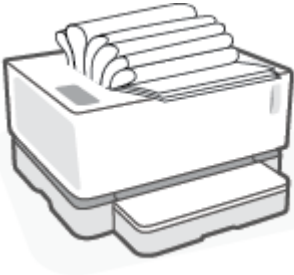
Introduction

Use the troubleshooting information to help resolve issues.

Wireless connectivity checklist

- Verify that the printer and the wireless router are turned on and have power. Also make sure that the wireless radio in the printer is turned on. The Wireless light (📶) should be blue to indicate that the printer is connected. (If the light is blinking, the printer is in setup mode or attempting to connect.)
- Verify that the network name (service set identifier, or SSID) is correct. Print a configuration page to determine the SSID.
 - a. Press and hold the Resume (📄) button for three seconds.
 - b. Release the Resume (📄) button.

If you are not sure the SSID is correct, run the wireless setup again.

- With secured networks, verify that the security information is correct. If the security information is incorrect, run the wireless setup again.
- Verify that the encryption method (AES or TKIP) is the same for the printer as it is for the wireless access point (on networks using WPA security).
- Check the Wi-Fi Signal Strength indicator (📶 or 📶) on the control panel. If only one or two bars or dots are showing, the wireless signal is weak. Verify that the printer is within the range of the wireless network. For most networks, the printer must be within 30 m (100 ft) of the wireless access point (wireless router).

- Verify that obstacles do not block the wireless signal. Remove any large metal objects between the access point and the printer. Make sure poles, walls, or support columns containing metal or concrete do not separate the printer and wireless access point.
- Verify that the printer is located away from electronic devices that might interfere with the wireless signal. Many devices can interfere with the wireless signal including motors, cordless phones, security system cameras, other wireless networks, and some Bluetooth devices.
- Verify that your router is set for 2.4 GHz operation. The printer only supports connections using this frequency.
- Verify that the print driver is installed on the computer.
- Verify that you have selected the correct printer port.
- Verify that the computer and printer connect to the same wireless network.
- For OS X, verify that the wireless router supports Bonjour.

Perform a wireless network diagnostic test

A wireless network diagnostic test can be performed using the printer control panel or the Embedded Web Server (EWS). The wireless network diagnostic test provides information about the wireless network settings.

Method one: Perform a wireless network diagnostic test using the printer control panel

- ▲ From the printer control panel, press and hold the Wireless button  for 10 seconds.

Method two: Perform wireless network diagnostic test using the EWS

1. Open the HP Embedded Web Server (EWS).
 - Use the HP Smart app to access the EWS, if available.
 - Use the HP Printer Assistant for Windows 7 systems.
 - Press and hold the Resume button  to print a configuration page, then navigate to the IP address shown on the printer configuration page.

 <https://10.10.XXXXX/>

 **NOTE:** If you receive a message indicating that accessing the website might not be safe, select the option to continue to the website. Accessing this website will not harm the computer.

2. Select the **Networking** tab.
3. On the **Wireless Configuration** page, verify that the On option is selected.
4. Click the **Print Test Report** button to print a test page that shows test results.

The printer does not print after the wireless configuration completes



1. Make sure that the printer is turned on and in the ready state.
2. Make sure that the wireless network is working correctly.

3. Make sure that your computer or mobile device is working correctly. If necessary, restart your computer or mobile device.
4. Make sure that the correct printer driver is installed (Windows).
5. Verify that you can open the printer HP Embedded Web Server from a computer or mobile device on the network.
6. Print a configuration page to verify the printer successfully connected to the wireless network and is assigned an IP address.

The printer does not print, and the computer has a third-party firewall installed



1. Update the firewall with the most recent update available from the manufacturer.
2. If programs request firewall access when you install the printer or try to print, make sure you allow the programs to run.
3. Temporarily turn off the firewall, and then install the wireless printer on the computer. Enable the firewall when you have completed the wireless installation.

The wireless connection does not work after moving the wireless router or printer

1. Check the Wi-Fi Signal Strength indicator ( or ) on the printer control panel. If only one or two bars or dots are showing, the wireless signal is weak. Verify that the printer is within the range of the wireless network. For most networks, the printer must be within 30 m (100 ft) of the wireless access point (wireless router). Also, make sure there are no large obstacles between the printer and the network router that could be blocking the signal and remove any electronic devices near the printer that could be interfering with the wireless signal.
2. Print a configuration page.
3. Compare the network name (SSID) on the configuration report to the SSID of the network the computer is on.

If the SSIDs are not the same, the devices are not connecting to the same network. Reconfigure the wireless setup for the printer.

Cannot connect more devices to the wireless printer (Wi-Fi Direct)

1. Make sure that each device is within the wireless range and that no obstacles block the signal. (For Wi-Fi Direct printing, the device must be within wireless range of the printer.)
2. Make sure that the printer is turned on and in the ready state.
3. Make sure that Wi-Fi Direct light  on the printer control panel is on. If it is off, press the Wi-Fi Direct button .
4. Make sure that you have turned on Wi-Fi Direct or Wi-Fi on your device. If your device supports neither, you cannot set up a Wi-Fi Direct connection with that device.
5. Make sure there are not more than 5 concurrent Wi-Fi Direct users.
6. Make sure that your computer is working correctly. If necessary, restart the computer.



The wireless printer loses communication when connected to a VPN

- Typically, you cannot connect to a VPN and other networks at the same time.

The network does not appear in the wireless networks list

- Make sure the wireless router is turned on and has power.
- The network might be hidden.
- Make sure that the printer is within wireless range of the wireless router, and that there are no obstacles blocking the signal.
- The printer operates on the 2.4 GHz wireless band. Any 5 GHz networks will not show up in the list.
- Refresh the wireless networks list.
- Try restarting the printer.

The wireless network is not functioning

1. To verify if the network has lost communication, try connecting other devices to the network.
2. Test network communication by pinging the network.
 - a. Open a command-line prompt on your computer.
 - For Windows, click **Start**, click **Run**, type `cmd`, and then press **Enter**.
 - For OS X, go to **Applications**, then **Utilities**, and open **Terminal**.
 - b. Type `ping` followed by the router IP address.
 - c. If the window displays round-trip times, the network is working.
3. Make sure that the router or printer connects to the same network that the computer connects to.
 - a. Print a configuration page.
 - i. Press and hold the Resume  button for three seconds.
 - ii. Release the Resume  button.
 - b. Compare the network name (SSID) on the configuration report to the SSID of the network the computer is on.

If the SSIDs are not the same, the devices are not connecting to the same network. Reconfigure the wireless setup for the printer.
4. Perform a wireless network diagnostic test. For more information, see the Perform a wireless network diagnostic test section of this User Guide.

Reduce interference on a wireless network

The following tips can reduce interference in a wireless network:

- Keep the wireless devices away from large metal objects, such as filing cabinets, and other electromagnetic devices, such as microwaves and cordless telephones. These objects can disrupt radio signals.
- Keep the wireless devices away from large masonry structures and other building structures. These objects can absorb radio waves and lower signal strength.
- Position the wireless router in a central location in line of sight with the wireless printers on the network.

A Printer specifications

 **IMPORTANT:** The following specifications are correct at the time of publication, but they are subject to change. For current information, see www.hp.com/support/Neverstop1000.

- [Technical specifications](#)
- [Supported operating systems](#)
- [Printer dimensions](#)
- [Power consumption, electrical specifications, and acoustic emissions](#)
- [Operating-environment range](#)
- [Warning icons](#)
- [Laser Warning](#)

Technical specifications

See www.hp.com/support/Neverstop1000 for current information.

Supported operating systems

The following information applies to the printer-specific Windows PCLmS and OS X print drivers.

Windows: The HP Software Installer installs the PCLmS, or PCLm-S driver depending on the Windows operating system, along with optional software when using the software installer. For more information, visit the product support website at www.hp.com/support/Neverstop1000.

OS X: Mac computers are supported with this printer. Download HP Easy Start either from 123.hp.com or from the product support website at www.hp.com/support/Neverstop1000, and then use HP Easy Start to install the HP print driver. HP Easy Start is not included in the HP Software Installer.

1. Go to 123.hp.com.
2. Follow the steps provided to download the printer software.

Linux: For information and print drivers for Linux, go to www.hp.com/go/linuxprinting.

Table A-1 Supported operating systems and print drivers

Windows 7, 32-bit and 64-bit	The HP PCLmS printer-specific print driver is installed for this operating system as part of the software installation.
------------------------------	---

Table A-1 Supported operating systems and print drivers (continued)

Windows 8, 32-bit and 64-bit	The HP PCLmS printer-specific print driver is installed for this operating system as part of the software installation.	Windows 8 RT support is provided through Microsoft IN OS Version 4, 32-bit driver.
Windows 8.1, 32-bit and 64-bit	The HP PCLm-S V4 printer-specific print driver is installed for this operating system as part of the software installation.	Windows 8.1 RT support is provided through Microsoft IN OS Version 4, 32-bit driver.
Windows 10, 32-bit and 64-bit	The HP PCLm-S V4 printer-specific print driver is installed for this operating system as part of the software installation.	
Windows Server 2008 R2, 64-bit	The HP PCLm.S printer-specific print driver is available for download from the printer-support website. Download the driver, and then use the Microsoft Add Printer tool to install it.	Microsoft retired mainstream support for Windows Server 2008 in January 2015. HP will continue to provide best effort support for the discontinued Server 2008 operating system.
Windows Server 2008 R2, SP1, 64-bit	The HP PCLmS printer-specific print driver is installed for this operating system as part of the software installation.	
Windows Server 2012	The HP PCLmS printer-specific print driver is installed for this operating system as part of the software installation.	
Windows Server 2012 R2	The HP PCLm-S printer-specific print driver is installed for this operating system as part of the software installation.	
Windows Server 2016, 64-bit	The HP PCLm-S printer-specific print driver is installed for this operating system as part of the software installation.	
OS X 10.11 El Capitan and later.	To install the print driver, download HP Easy Start from 123.hp.com . Follow the steps provided to install the printer software and print driver.	



NOTE: For a current list of supported operating systems, go to www.hp.com/support/Neverstop1000 for HP's all-inclusive help for the printer.

Printer dimensions

Figure A-1 Dimensions for the printer

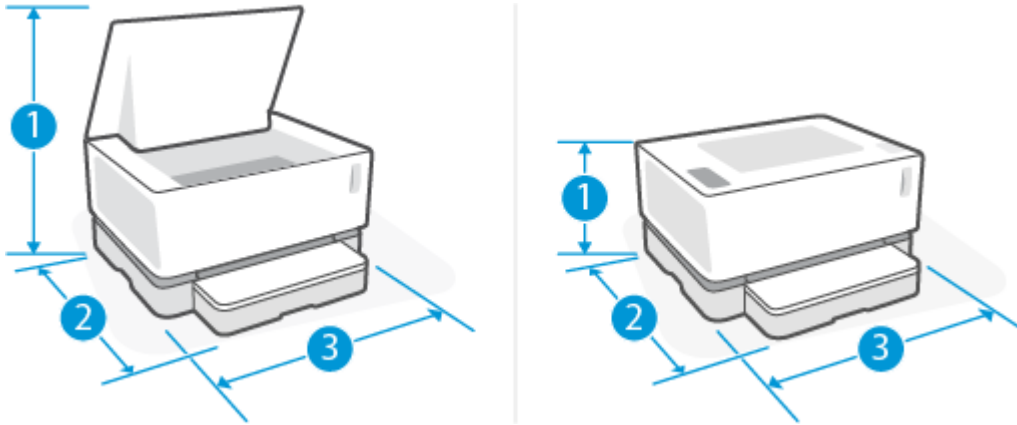

	Printer fully open	Printer fully closed
1. Height	445 mm (17.5 in)	211 mm (8.3 in)
2. Depth	465 mm (18.3 in)	371.5 mm (14.6 in)
2. Width	380.5 mm (14.9 in)	380.5 mm (14.9 in)
Weight (with imaging drum)	6.96 kg (15.34 lbs) (base models)	
	7.01 kg (15.45 lbs) (wireless models)	

Power consumption, electrical specifications, and acoustic emissions

See www.hp.com/support for current information.

CAUTION: Power requirements are based on the country/region where the printer is sold. Do not convert operating voltages. This will damage the printer and void the printer warranty.

Operating-environment range

Environment	Recommended	Allowed
Temperature	17.5° to 25°C (63.5° to 77°F)	15° to 32°C (59° to 89.6°F)
Relative humidity	20% to 70% relative humidity (RH), non-condensing	10% to 80% (RH), non-condensing
Altitude	Not applicable	0 to 5000 m (0 to 16,404 ft)

Warning icons

Warning icon definitions: The following warning icons may appear on HP products. Apply appropriate caution where applicable.

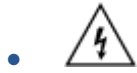

Caution: Electric shock



Caution: Hot surface



Caution: Keep body parts away from moving parts



Caution: Sharp edge in close proximity



Warning

Laser Warning



CAUTION - CLASS 3B INVISIBLE LASER RADIATION WHEN OPEN. AVOID EXPOSURE TO THE BEAM.

ATTENTION - RAYONNEMENT LASER INVISIBLE DE CLASSE 3B EN CAS D'OUVERTURE. ÉVITEZ L'EXPOSITION AU FAISCEAU.

VORSICHT - UNSICHTBARE LASERSTRAHLUNG KLASSE 3B, WENN ABDECKUNG GEÖFFNET. NICHT DEM STRAHL AUSSETZEN.

PRECAUCIÓN – RADIACIÓN LÁSER INVISIBLE DE CLASE 3B PRESENTE AL ABRIR. EVITE LA EXPOSICIÓN AL HAZ.

VARNING - OSYNLIG LASERSTRÅLNING KLASSE 3B VID ÖPPEN LUCKA UNDVIK EXPONERING FÖR LASERSTRÅLNINGEN.

VAROITUS - LUOKAN 3B NÄKYMÄTTÖMÄLLE LASER-SÄTEILYÄ AVATTUNA. VÄLTÄ ALTISTUMISTA SÄTEELLE.

注意 - 打开时，存在不可见的 3B 类激光辐射，请避免接触该激光束。

주의 - 열리면 등급 3B 비가시레이저방사선이 방출됩니다. 광선에 노출을 피하십시오.

注意 - ここを開くとクラス 3B 不可視レーザー放射が出ます。ビームに身をさらさないこと。

Index

A

acoustic specifications 79

B

bin, output

 jams, clearing 62

bins, output

 locating 2

browser requirements

 HP Embedded Web Server 16

buttons, control panel 3

C

checklist

 wireless connectivity 72

clearing jams

 locations 57

control panel

 buttons 3

 features 3

 LED light patterns 52

 locating 2

covers, locating 2

customer support

 warranty 50

D

defaults, restoring 55

dimensions, printer 79

double-sided printing 37

drivers, supported 77

duplexing 37

E

economy settings 20

electrical specifications 79

Embedded Web Server (EWS)

 assigning passwords 19

 features 16

envelope, loading 30

envelope, orientation 30

Explorer, versions supported

 HP Embedded Web Server 16

F

factory-set defaults, restoring 55

H

HP Device Toolbox, using 16

HP Embedded Web Server (EWS)

 features 16

HP EWS, using 16

I

image quality issues

 examples and solutions 67

input tray

 jams, clearing 59

 locating 2

interface ports

 locating 2

Internet Explorer, versions supported

 HP Embedded Web Server 16

J

jams

 locations 57

 output-bin, clearing 62

 tray, clearing 59

L

label

 orientation 32

labels

 printing on 32

labels, loading 32

M

manual duplex

 Windows 37

media

 ordering 48

memory

 included 77

mobile printing solutions 77

multiple pages per sheet

 printing (Windows) 37

N

network connection

 wireless connection 8

network installation 23

network port

 locating 2

networks

 installing the printer 23

 supported 77

O

on/off button, locating 2

operating systems (OS)

 supported 77

operating systems, supported 77

ordering

 supplies and accessories 48

OS (operating system)

 supported 77

output bin

 locating 2

P

pages per minute 77

pages per sheet

 selecting (Windows) 37

- paper
 - loading 25, 27
 - selecting 65
- paper jams. *See* jams
- paper pickup problems
 - solving 56
- paper type
 - selecting (Windows) 36
- paper, ordering 48
- power
 - consumption 79
- power connection
 - locating 2
- power switch, locating 2
- power-down delay
 - setting 21
- print drivers, supported 77
- print on both sides
 - manually, Windows 37
- product and serial number label
 - locating 2

R
restoring factory-set defaults 55

S
serial number label

- locating 2

- settings
- factory-set defaults, restoring 55
- shut down after delay
- setting 20
- single-sheet priority feed slot
- loading labels 32
- sleep delay
- disabling 20
- enabling 20
- specifications
- electrical and acoustic 79
- status
- control panel lights 52
- supplies
- ordering 48
- system requirements
- HP Embedded Web Server 16

T
tray

- capacity 77
- included 77

- troubleshooting
 - LED, errors 52
 - LED, light patterns 52
 - paper feed problems 56
 - wireless network 72

U
USB port

- locating 2

W
warranty 50
web browser requirements

- HP Embedded Web Server 16

- weight, printer 79
- wireless network
- troubleshooting 72
- wireless network interference 75