

PIN OUT

CN1	CN2	COLOR
3	2	BLACK
4	3	RED
5	4	GREEN
6	5	YELLOW

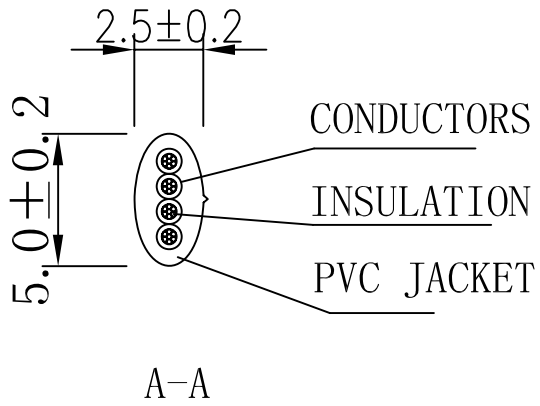

③	CONNECTER	1PCS	RJ11(6P4C) MALE TYPE CLEAR POLYESTER, UL94V-2. BRASS, GOLD PLATED
②	CONNECTER	1PCS	RJ45(8P4C) MALE TYPE CLEAR POLYESTER, UL94V-2. BRASS, GOLD PLATED
①	CABLE	1PCS	28AWG*4C+PVC+PVC JACKET WHITE PVC JACKET OD:2.5*5.0±0.2mm
NO.	PARTS NAME	Q'TY	SPECIFICATION

NOTES:
 1. TESTING: 100% OPEN AND SHORT TEST.
 2. ALL MATERIAL BE RoHS COMPLIANT.

APPROVED	CHECKED	DRAWN	CUSTOMER:	DESCRIPTION: RJ45(8P4C)MALE/RJ11(6P4C)MALE	
			ITEM NO. DEL-1705		
			DRAW NO.		
			UNIT mm		
			SCALE NONE		