

**TOSHIBA**  
**Satellite A300 / A300D**  
**Satellite Pro A300 / A300D**  
Portable Personal Computer  
User's Manual

## Copyright

© 2008 by TOSHIBA Corporation. All rights reserved. Under the copyright laws, this manual cannot be reproduced in any form without the prior written permission of TOSHIBA. No patent liability is assumed, with respect to the use of the information contained herein.

*TOSHIBA Satellite A300/A300D, Satellite Pro A300/A300D Series Portable Personal Computer User's Manual*

First edition January 2008

Ownership and copyright of music, video, computer programs, databases, etc. are protected by the copyright laws. These copyrighted materials may be copied for private use at home only. If, beyond the limitation above, you copy (including to transform data formats) or modify these materials, transfer them or distribute them via the Internet without approval of copyright owners, you may be subject to claims for compensation for damage and/or criminal penalties due to infringements of copyrights or personal rights. Please remember to observe the copyright laws when you use this product to copy the copyrighted works or perform other actions.

Please note that you may infringe the owner's rights protected by the copyright laws if you use the screen mode switching functions (e.g. Wide mode, Wide Zoom mode, etc.) of this product to display enlarged images/video at coffee shops or hotels for the purposes of profits or providing these to the public.



*This product incorporates copyright protection technology that is protected by U.S. patents and other intellectual property rights. Use of this copyright protection technology must be authorized by Macrovision, and is intended for home and other limited viewing uses only unless otherwise authorized by Macrovision. Reverse engineering or disassembly is prohibited.*

## Disclaimer

This manual has been validated and reviewed for accuracy. The instructions and descriptions it contains are accurate for the TOSHIBA Satellite A300/A300D, Satellite Pro A300/A300D Series Portable Personal Computer at the time of this manual's production. However, succeeding computers and manuals are subject to change without notice. TOSHIBA assumes no liability for damages incurred directly or indirectly from errors, omissions or discrepancies between the computer and the manual.

## Trademarks

Microsoft, Windows® and Windows Vista are either registered trademarks or trademarks of Microsoft Corporation in the United States and/or other countries.

DirectX, AcriveDesktop, DirectShow, and Windows Media are registered trademarks of Microsoft Corporation.

Intel, Intel Core, Celeron, Centrino and Pentium are trademarks or registered trademarks of Intel Corporation or its subsidiaries in the United States and other countries.

AMD, the AMD Arrow logo, AMD Athlon, AMD Turion, Radeon, and combinations thereof, ATI Mobility Radeon are trademarks of Advanced Micro Devices, Inc.

Adobe and Photoshop are either registered trademarks or trademarks of Adobe Systems Incorporated in the United States and/or other countries.

Bluetooth™ is a registered trademark owned by its proprietor and used by TOSHIBA under license.

ConfigFree is a trademark of TOSHIBA Corporation.

HD DVD Logo is a Trademark of DVD Format/Logo Licensing Corporation.

DVD MovieFactory is trademarks of the Ulead Systems. Inc.

BizCard is a trademark of NewSoft Technology Corporation.

Dolby is a registered trademark of Dolby Laboratories.

ExpressCard is a trade mark of PCMCIA.

HDMI, the HDMI logo and High-Definition Multimedia Interface are trademarks or registered trademarks of HDMI Licensing LLC.

Labelflash(TM) is a trademark of YAMAHA CORPORATION.

Memory Stick, Memory Stick PRO, and i.LINK are registered trademark and i.LINK is a trademark of SonyCorporation.

MultiMediaCard and MMC are trademarks of MultiMediaCard Association.

Photo CD is a trademark of Eastman Kodak.

Secure Digital and SD are trademarks of SD Card Association.

xD-Picture Card is a trademark of Fuji Photo Film, Co., Ltd.

Wi-Fi is as registered trademark of the Wi-Fi Alliance.

Other trademarks and registered trademarks not listed above may be used in this manual.

## Safety Instructions

Use the following safety guidelines to help protect yourself and your computer.

### When Using Your Computer



*Do not operate your portable computer for an extended period of time with the base resting directly on your body. With extended operation, heat can potentially build up in the base. Allowing sustained contact with the skin could cause discomfort or, eventually, a burn.*

- Do not attempt to service the computer yourself. Always follow installation instructions closely.
- Do not carry a battery in your pocket, purse, or other container where metal objects (such as car keys) could short-circuit the battery terminals. The resulting excessive current flow can cause extremely high temperatures and may result in damage from burns.
- Be sure that nothing rests on your AC adapter's power cable and that the cable is not located where it can be tripped over or stepped on.
- Place the AC adapter in a ventilated area, such as a desk top or on the floor, when you use it to run the computer or to charge the battery. Do not cover the AC adapter with papers or other items that will reduce cooling; also, do not use the AC adapter while it is inside a carrying case.
- Use only the AC adapter and batteries that are approved for use with this computer. Use of another type of battery or AC adapter may risk fire or explosion.
- Before you connect the computer to a power source, ensure that the voltage rating of the AC adapter matches that of the available power source. 115V/60 Hz in most of North and South America and some Far Eastern countries such as Taiwan. 100 V/50 Hz in eastern Japan and 100 V/60 Hz in western Japan. 230 V/50 Hz in most of Europe, the Middle East, and the Far East.
- If you use an extension cable with your AC adapter, ensure that the total ampere rating of the products plugged in to the extension cable does not exceed the ampere rating of the extension cable.
- To remove power from the computer, turn it off, remove the battery, and disconnect the AC adapter from the electrical outlet.
- To help avoid the potential hazard of electric shock, do not connect or disconnect any cables or perform maintenance or reconfiguration of this product during an electrical storm.
- When setting up the computer for work, place it on a level surface.

## FCC information

### FCC notice “Declaration of Conformity Information”

This equipment has been tested and found to comply with the limits for a Class B digital device, pursuant to part 15 of the FCC rules. These limits are designed to provide reasonable protection against harmful interference in a residential installation. This equipment generates, uses and can radiate radio frequency energy and, if not installed and used in accordance with the instructions, may cause harmful interference to radio communications. However, there is no guarantee that interference will not occur in a particular installation. If this equipment does cause harmful interference to radio or television reception, which can be determined by turning the equipment off and on, the user is encouraged to try to correct the interference by one or more of the following measures:

- Reorient or relocate the receiving antenna.
- Increase the separation between the equipment and receiver.
- Connect the equipment into an outlet on a circuit different from that to which the receiver is connected.
- Consult the dealer or an experienced radio/TV technician for help.



*Only peripherals complying with the FCC class B limits may be attached to this equipment. Operation with non-compliant peripherals or peripherals not recommended by TOSHIBA is likely to result in interference to radio and TV reception. Shielded cables must be used between the external devices and the computer's external monitor port, USB port, serial port, parallel port, PS/2 mouse/keyboard port and microphone jack. Changes or modifications made to this equipment, not expressly approved by TOSHIBA or parties authorized by TOSHIBA could void the user's authority to operate the equipment.*

### FCC conditions

This device complies with part 15 of the FCC Rules. Operation is subject to the following two conditions:

1. This device may not cause harmful interference.
2. This device must accept any interference received, including interference that may cause undesired operation.

### Contact

Address: TOSHIBA America Information Systems, Inc.  
9740 Irvine Boulevard  
Irvine, California 92618-1697

Telephone: (949) 583-3000

## EU Declaration of Conformity



TOSHIBA declares that this product conforms to the following Standards:

Supplementary Information:	“The product complies with the requirements of the Low Voltage Directive 2006/95/EC, the EMC Directive 2004/108/EC and/or the R&TTE Directive 1999/5/EC.”
----------------------------	---

This product is carrying the CE-Mark in accordance with the related European Directives. Responsible for CE-Marking is TOSHIBA Europe, Hammfelddamm 8, 41460 Neuss, Germany.

## VCCI Class B Information

この装置は、情報処理装置等電波障害自主規制協議会（VCCI）の基準に基づくクラスB情報技術装置です。この装置は、家庭環境で使用することを目的としていますが、この装置がラジオやテレビジョン受信機に近接して使用されると、受信障害を引き起こすことがあります。  
取扱説明書に従って正しい取り扱いをして下さい。

## Canadian Regulatory Information (Canada Only)

This digital apparatus does not exceed the Class B limits for radio noise emissions from digital apparatus as set out in the Radio Interference Regulation of the Canadian Department of Communications.

Note that Canadian Department of Communications (DOC) regulations provide, that changes or modifications not expressly approved by TOSHIBA Corporation could void your authority to operate this equipment.

This Class B digital apparatus meets all requirements of the Canadian Interference-Causing Equipment Regulations.

Cet appareil numérique de la class B respecte toutes les exigences du Règlement sur le matériel brouilleur du Canada.

## Modem warning notice

### Conformity Statement

The equipment has been approved to [Council Decision 98/482/EC - "TBR 21"] for pan-European single terminal connection to the Public Switched Telephone Network (PSTN).

However, due to differences between the individual PSTNs provided in different countries/regions the approval does not, of itself, give an unconditional assurance of successful operation on every PSTN network termination point.

In the event of problems, you should contact your equipment supplier in the first instance.

### Network Compatibility Statement

This product is designed to work with, and is compatible with the following networks. It has been tested to and found to conform with the additional requirements conditional in EG 201 121.

Germany	ATAAB AN005, AN006, AN007, AN009, AN010 and DE03, 04, 05, 08, 09,12,14,17
Greece	ATAAB AN005, AN006 and GR01, 02, 03, 04
Portugal	ATAAB AN001, 005, 006, 007, 011 and P03, 04, 08, 10
Spain	ATAAB AN005, 007, 012, and ES01
Switzerland	ATAAB AN002
All other countries/ regions	ATAAB AN003, 004

Specific switch settings or software setup are required for each network, please refer to the relevant sections of the user guide for more details.

The hookflash (timed break register recall) function is subject to separate national type approvals. It has not been tested for conformity to national type regulations, and no guarantee of successful operation of that specific function on specific national networks can be given.

## Japan regulations

### *Region selection*

If you are using the computer in Japan, technical regulations described in the Telecommunications Business Law require that you select the Japan region mode. It is illegal to use the modem in Japan with any other selection.

### *Redial*

Up to two redial attempts can be made. If more than two redial attempts are made, the modem will return Black Listed. If you are experiencing problems with the Black Listed code, set the interval between redials at one minute or longer.

Japan's Telecommunications Business Law permits up to two redials on analogue telephones, but the redials must be made within a total of three minutes.

The internal modem is approved by Japan Approvals Institute for Telecommunications Equipment.



A06-5003201

## Pursuant to FCC CFR 47, Part 68:

When you are ready to install or use the modem, call your local telephone company and give them the following information:

- The telephone number of the line to which you will connect the modem.
- The registration number that is located on the device  
US : CXSMM01BRD02D450

The FCC registration number of the modem will be found on either the device which is to be installed, or, if already installed, on the bottom of the computer outside of the main system label.

- The Ringer Equivalence Number (REN) of the modem, which can vary.  
For the REN of your modem, refer to your modem's label.

The modem connects to the telephone line by means of a standard jack called the USOC RJ11C.

### *Type of service*

Your modem is designed to be used on standard-device telephone lines. Connection to telephone company-provided coin service (central office implemented systems) is prohibited. Connection to party lines service is subject to state tariffs.

If you have any questions about your telephone line, such as how many pieces of equipment you can connect to it, the telephone company will provide this information upon request.



## **Telephone company procedures**

The goal of the telephone company is to provide you with the best service it can. In order to do this, it may occasionally be necessary for them to make changes in their equipment, operations, or procedures. If these changes might affect your service or the operation of your equipment, the telephone company will give you notice in writing to allow you to make any changes necessary to maintain uninterrupted service.

### **If problems arise**

If any of your telephone equipment is not operating properly, you should immediately remove it from your telephone line, as it may cause harm to the telephone network. If the telephone company notes a problem, they may temporarily discontinue service. When practical, they will notify you in advance of this disconnection. If advance notice is not feasible, you will be notified as soon as possible. When you are notified, you will be given the opportunity to correct the problem and informed of your right to file a complaint with the FCC. In the event repairs are ever needed on your modem, they should be performed by TOSHIBA Corporation or an authorized representative of TOSHIBA Corporation.

### **Disconnection**

If you should ever decide to permanently disconnect your modem from its present line, please call the telephone company and let them know of this change.

### **Fax branding**

The Telephone Consumer Protection Act of 1991 makes it unlawful for any person to use a computer or other electronic device to send any message via a telephone fax machine unless such message clearly contains in a margin at the top or bottom of each transmitted page or on the first page of the transmission, the date and time it is sent and an identification of the business, other entity or individual sending the message and the telephone number of the sending machine or such business, other entity or individual. In order to program this information into your fax modem, you should complete the setup of your fax software before sending messages.



*Use only No.26AWG or larger telecommunication line cord.*

## Instructions for IC CS-03 certified equipment

1. The Industry Canada label identifies certified equipment. This certification means that the equipment meets certain telecommunications network protective, operational and safety requirements as prescribed in the appropriate Terminal Equipment Technical Requirements document(s). The Department does not guarantee the equipment will operate to the user's satisfaction.

Before installing this equipment, users should ensure that it is permissible to be connected to the facilities of the local telecommunications company. The equipment must also be installed using an acceptable method of connection.

The customer should be aware that compliance with the above conditions may not prevent degradation of service in some situations. Repairs to certified equipment should be coordinated by a representative designated by the supplier. Any repairs or alterations made by the user to this equipment, or equipment malfunctions, may give the telecommunications company cause to request the user to disconnect the equipment.

Users should ensure for their own protection that the electrical ground connections of the power utility, telephone lines and internal metallic water pipe system, if present, are connected together. This precaution may be particularly important in rural areas.



*Users should not attempt to make such connections themselves, but should contact the appropriate electric inspection authority, or electrician, as appropriate.*

2. The user manual of analog equipment must contain the equipment's Ringer Equivalence Number (REN) and an explanation notice similar to the following:

The Ringer Equivalence Number (REN) of the modem, which can vary. For the REN of your modem, refer to your modem's label.



*The Ringer Equivalence Number (REN) assigned to each terminal device provides an indication of the maximum number of terminals allowed to be connected to a telephone interface. The termination on an interface may consist of any combination of devices subject only to the requirement that the sum of the Ringer Equivalence Numbers of all the devices does not exceed 5.*

3. The standard connecting arrangement (telephone jack type) for this equipment is jack type(s): USOC RJ11C.

The IC registration number of the modem is shown below.

Canada: 3652B-RD02D450

## Notes for Users in Australia and New Zealand

### ***Modem warning notice for Australia***

Modems connected to the Australian telecoms network must have a valid Austel permit. This modem has been designed to specifically configure to ensure compliance with Austel standards when the country/region selection is set to Australia. The use of other country/region setting while the modem is attached to the Australian PSTN would result in you modem being operated in a non-compliant manner. To verify that the country/region is correctly set, enter the command ATI9 which displays the currently active setting.

To set the country/region permanently to Australia, enter the following command sequence:

```
AT+GCI=09
```

Failure to set the modem to the Australia country/region setting as shown above will result in the modem being operated in a non-compliant manner. Consequently, there would be no permit in force for this equipment and the Telecoms Act 1991 prescribes a penalty of \$12,000 for the connection of non-permitted equipment.

### ***Notes for use of this device in New Zealand***

- The grant of a Telepermit for a device in no way indicates Telecom acceptance of responsibility for the correct operation of that device under all operating conditions. In particular the higher speeds at which this modem is capable of operating depend on a specific network implementation which is only one of many ways of delivering high quality voice telephony to customers. Failure to operate should not be reported as a fault to Telecom.
- In addition to satisfactory line conditions a modem can only work properly if:
  - a/ it is compatible with the modem at the other end of the call and
  - b/ the application using the modem is compatible with the application at the other end of the call - e.g., accessing the Internet requires suitable software in addition to a modem.
- This equipment shall not be used in any manner which could constitute a nuisance to other Telecom customers.
- Some parameters required for compliance with Telecom's PTC Specifications are dependent on the equipment (PC) associated with this modem. The associated equipment shall be set to operate within the following limits for compliance with Telecom Specifications:
  - a/ There shall be no more than 10 call attempts to the same number within any 30 minute period for any single manual call initiation, and
  - b/ The equipment shall go on-hook for a period of not less than 30 seconds between the end of one attempt and the beginning of the next.
  - c/ Automatic calls to different numbers shall be not less than 5 seconds apart.

- Immediately disconnect this equipment should it become physically damaged, and arrange for its disposal or repair.
- The correct settings for use with this modem in New Zealand are as follows:
  - ATB0 (CCITT operation)
  - AT&G2 (1800 Hz guard tone)
  - AT&P1 (Decadic dialling make-break ratio = 33%/67%)
  - ATS0=0 (not auto answer)
  - ATS10=less than 150 (loss of carrier to hang up delay, factory default of 15 recommended)
  - ATS11=90 (DTMF dialling on/off duration=90 ms)
  - ATX2 (Dial tone detect, but not (U.S.A.) call progress detect)
- When used in the Auto Answer mode, the S0 register must be set with a value of 3 or 4. This ensures:
  - a person calling your modem will hear a short burst of ringing before the modem answers. This confirms that the call has been successfully switched through the network.
  - caller identification information (which occurs between the first and second ring cadences) is not destroyed.
- The preferred method of dialling is to use DTMF tones (ATDT...) as this is faster and more reliable than pulse (decadic) dialling. If for some reason you must use decadic dialling, your communications program must be set up to record numbers using the following translation table as this modem does not implement the New Zealand "Reverse dialling" standard.
  - Number to be dialled: 0 1 2 3 4 5 6 7 8 9
  - Number to program into computer: 0 9 8 7 6 5 4 3 2 1Note that where DTMF dialling is used, the numbers should be entered normally.
- The transmit level from this device is set at a fixed level and because of this there may be circumstances where the performance is less than optimal. Before reporting such occurrences as faults, please check the line with a standard Telepermitted telephone, and only report a fault if the phone performance is impaired.
- It is recommended that this equipment be disconnected from the Telecom line during electrical storms.
- When relocating the equipment, always disconnect the Telecom line connection before the power connection, and reconnect the power first.
- This equipment may not be compatible with Telecom Distinctive Alert cadences and services such as FaxAbility.

**NOTE THAT FAULT CALLOUTS CAUSED BY ANY OF THE ABOVE CAUSES MAY INCUR A CHARGE FROM TELECOM**

### General conditions

As required by PTC 100, please ensure that this office is advised of any changes to the specifications of these products which might affect compliance with the relevant PTC Specifications.

The grant of this Telepermit is specific to the above products with the marketing description as stated on the Telepermit label artwork. The Telepermit may not be assigned to other parties or other products without Telecom approval.

A Telepermit artwork for each device is included from which you may prepare any number of Telepermit labels subject to the general instructions on format, size and color on the attached sheet.

The Telepermit label must be displayed on the product at all times as proof to purchasers and service personnel that the product is able to be legitimately connected to the Telecom network.

The Telepermit label may also be shown on the packaging of the product and in the sales literature, as required in PTC 100.

The charge for a Telepermit assessment is \$337.50. An additional charge of \$337.50 is payable where an assessment is based on reports against non-Telecom New Zealand Specifications. \$112.50 is charged for each variation when submitted at the same time as the original.

An invoice for \$NZ1237.50 will be sent under separate cover.

### Following information is only for EU-member states:

The symbol indicates that this product may not be treated as household waste. Please ensure this product is properly disposed as inappropriate waste handling of this product may cause potential hazards to the environment and human health. For more detailed information about recycling of this product, please contact your local city office, your household waste disposal service or the shop where you purchased the product.



*This symbol may not stick depending on the country and region where you purchased.*

## ENERGY STAR® Program



Your computer model may be Energy Star® Compliant. If the model you purchased is compliant, it is labeled with the ENERGY STAR logo on the computer and the following information applies. TOSHIBA is a partner in the Environmental Protection Agency's (EPA) Energy Star Program and has designed this computer to meet the latest Energy Star guidelines for energy efficiency. Your computer ships with the power management options preset to a configuration that will provide the most stable operating environment and optimum system performance for both AC power and battery modes.

To conserve energy, your computer is set to enter the low-power Sleep Mode which shuts down the system and display within 15 minutes of inactivity in AC power mode. We recommend that you leave this and other energy saving features active, so that your computer will operate at its maximum energy efficiency. You can wake the computer from Sleep Mode by pressing the power button.

According to the EPA, a computer meeting the new ENERGY STAR specifications will use between 20% and 50% less energy depending on how it is used. If all U.S. household and businesses replaced old computers with new ENERGY STAR qualified models, we would save more than \$1.8 billion in energy costs over the next five years and avoid greenhouse gas emissions equivalent to more than 2.7 million cars. If every computer purchased by businesses next year met the new ENERGY STAR requirements, businesses would save more than \$210 million over the lifetime of those models. That is equivalent to lighting 120 million square feet of U.S. commercial building space each year.

Visit <http://www.energystar.gov> or <http://www.energystar.gov/powermanagement> for more information regarding the ENERGY STAR Program.

## Optical disc drive safety instructions



*Be sure to check the international precautions at the end of this section.*

## Hitach-LG Data Storage

### DVD Super Multi GSA-T40F/GSA-T40N



- *The DVD Super Multi drive employs a laser system. To ensure proper use of this product, please read this instruction manual carefully and retain for future reference. Should the unit ever require maintenance, contact an authorized service location.*
- *Use of controls, adjustments or the performance of procedures other than those specified may result in hazardous radiation exposure.*
- *To prevent direct exposure to the laser beam, do not try to open the enclosure.*

### Location of the required label

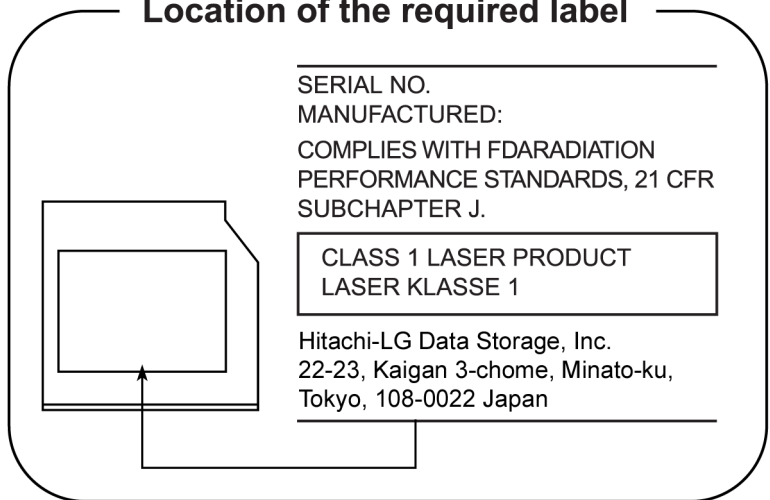

## Panasonic

### DVD Super Multi UJ-870B



- *The DVD Super Multi drive employs a laser system. To ensure proper use of this product, please read this instruction manual carefully and retain for future reference. Should the unit ever require maintenance, contact an authorized service location.*
- *Use of controls, adjustments or the performance of procedures other than those specified may result in hazardous radiation exposure.*
- *To prevent direct exposure to the laser beam, do not try to open the enclosure.*

### Location of the required label

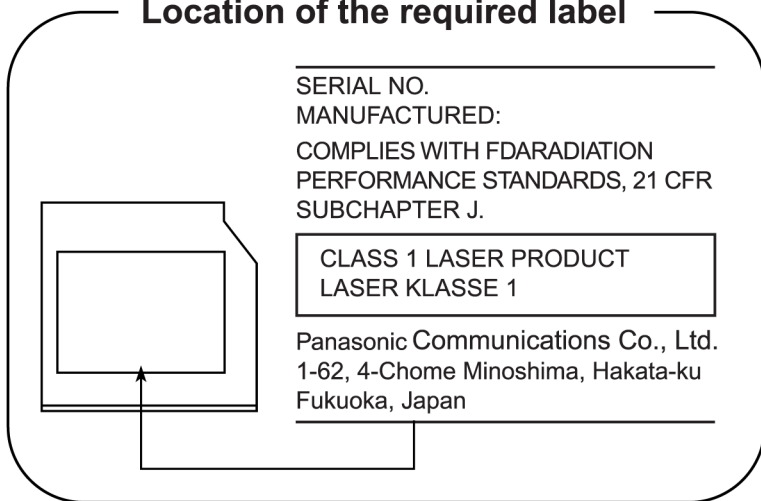



## Pioneer

### DVD Super Multi DVR-KD08



- *The DVD Super Multi drive employs a laser system. To ensure proper use of this product, please read this instruction manual carefully and retain for future reference. Should the unit ever require maintenance, contact an authorized service location.*
- *Use of controls, adjustments or the performance of procedures other than those specified may result in hazardous radiation exposure.*
- *To prevent direct exposure to the laser beam, do not try to open the enclosure.*

#### Location of the required label

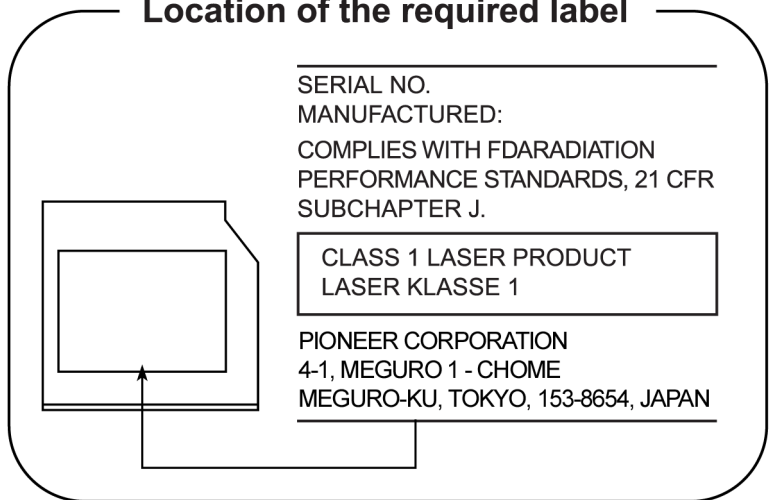

# TOSHIBA SAMSUNG STORAGE TECHNOLOGY

## CD-RW/DVD-ROM Drive TS-L462D



- *The CD-RW/DVD-ROM drive employs a laser system. To ensure proper use of this product, please read this instruction manual carefully and retain for future reference. Should the unit ever require maintenance, contact an authorized service location.*
- *Use of controls, adjustments or the performance of procedures other than those specified may result in hazardous radiation exposure.*
- *To prevent direct exposure to the laser beam, do not try to open the enclosure.*

### Location of the required label

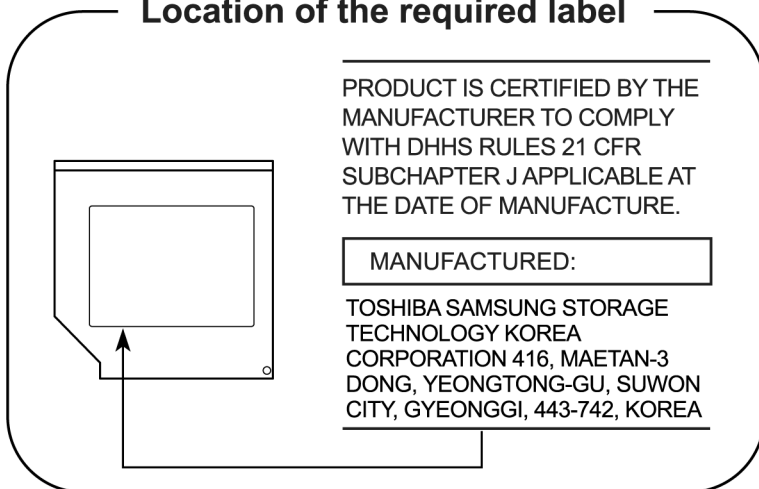

## TOSHIBA SAMSUNG STORAGE TECHNOLOGY

### 8x slim DVD Writable Drive TS-L632H



- *THIS DVD WRITABLE DRIVE EMPLOY A LASER SYSTEM TO ENSURE PROPER USE OF THIS PRODUCT, PLEASE READ THIS INSTRUCTION MANUAL CAREFULLY AND RETAIN FOR FUTURE REFERENCE. SHOULD THE UNIT EVER REQUIRE MAINTENANCE, CONTACT AN AUTHORIZED SERVICE LOCATION-SEE SERVICE PROCEDURE.*
- *USE OF CONTROLS OR ADJUSTMENTS OR THE PERFORMANCE OF PROCEDURES OTHER THAN THOSE SPECIFIED HEREIN MAY RESULT IN HAZARDOUS RADIATION EXPOSURE.*
- *TO PREVENT DIRECT EXPOSURE TO LASER BEAM, DO NOT TRY TO OPEN THE ENCLOSURE.*

### Location of the required label

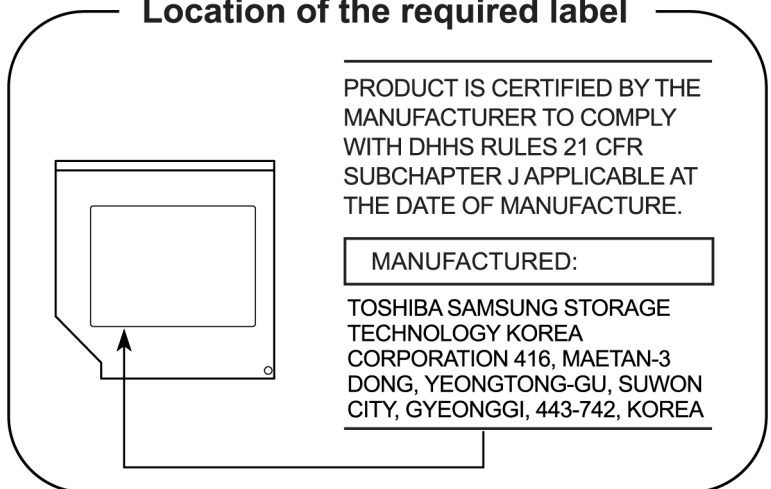

# TOSHIBA

## HD DVD-ROM Drive SD-L802B



- *THIS HD DVD-ROM DRIVE EMPLOY A LASER SYSTEM TO ENSURE PROPER USE OF THIS PRODUCT, PLEASE READ THIS INSTRUCTION MANUAL CAREFULLY AND RETAIN FOR FUTURE REFERENCE. SHOULD THE UNIT EVER REQUIRE MAINTENANCE, CONTACT AN AUTHORIZED SERVICE LOCATION-SEE SERVICE PROCEDURE.*
- *USE OF CONTROLS OR ADJUSTMENTS OR THE PERFORMANCE OF PROCEDURES OTHER THAN THOSE SPECIFIED HEREIN MAY RESULT IN HAZARDOUS RADIATION EXPOSURE.*
- *TO PREVENT DIRECT EXPOSURE TO LASER BEAM, DO NOT TRY TO OPEN THE ENCLOSURE.*

### Location of the required label

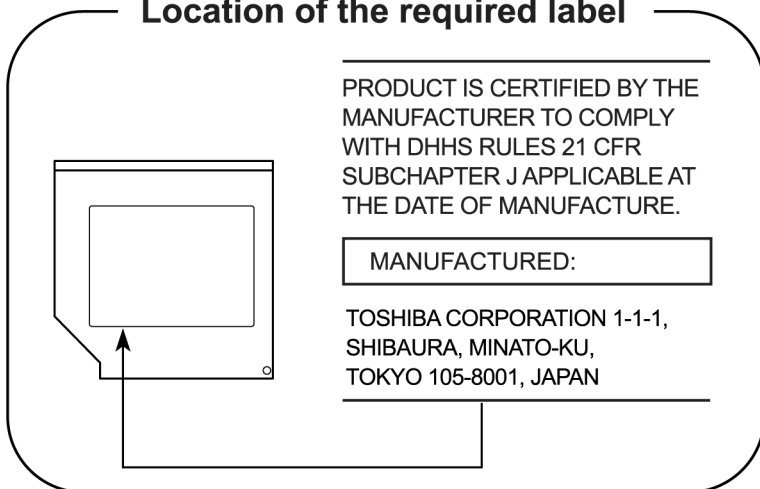

# TOSHIBA

## HD DVD-RW Drive SD-L912A



- *THIS DVD WRITABLE DRIVE EMPLOY A LASER SYSTEM TO ENSURE PROPER USE OF THIS PRODUCT, PLEASE READ THIS INSTRUCTION MANUAL CAREFULLY AND RETAIN FOR FUTURE REFERENCE. SHOULD THE UNIT EVER REQUIRE MAINTENANCE, CONTACT AN AUTHORIZED SERVICE LOCATION-SEE SERVICE PROCEDURE.*
- *USE OF CONTROLS OR ADJUSTMENTS OR THE PERFORMANCE OF PROCEDURES OTHER THAN THOSE SPECIFIED HEREIN MAY RESULT IN HAZARDOUS RADIATION EXPOSURE.*
- *TO PREVENT DIRECT EXPOSURE TO LASER BEAM, DO NOT TRY TO OPEN THE ENCLOSURE.*

### Location of the required label

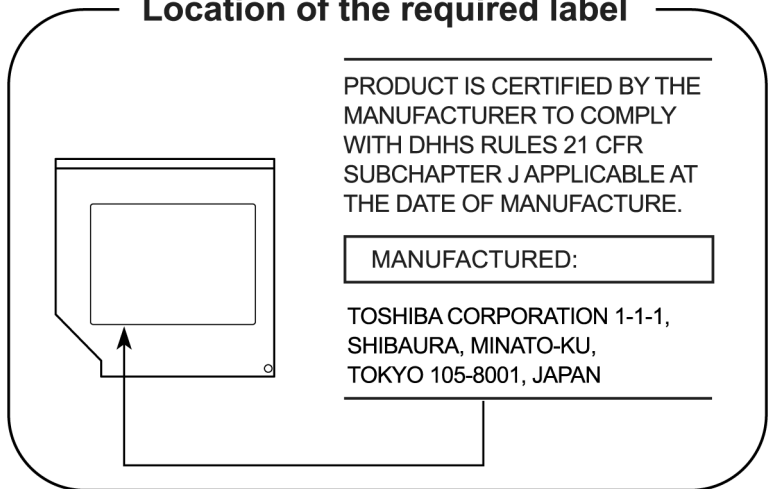

## International Precautions

CLASS 1 LASER PRODUCT  
LASER KLASSE 1 PRODUKT  
TO EN 60825-1  
クラス 1 レーザ 製品

**CAUTION:** This appliance contains a laser system and is classified as a "CLASS 1 LASER PRODUCT." To use this model properly, read the instruction manual carefully and keep this manual for your future reference. In case of any trouble with this model, please contact your nearest "AUTHORIZED service station." To prevent direct exposure to the laser beam, do not try to open the enclosure.

CLASS 1 LASER PRODUCT  
LASERSCHUTZKLASSE 1  
PRODUKT  
TOEN60825

**VORSICHT:** Dieses Gerät enthält ein Laser-System und ist als "LASERSCHUTZKLASSE 1 PRODUKT" klassifiziert. Für den richtigen Gebrauch dieses Modells lesen Sie bitte die Bedienungsanleitung sorgfältig durch und bewahren diese bitte als Referenz auf. Falls Probleme mit diesem Modell auftreten, benachrichtigen Sie bitte die nächste "autorisierte Service-Vertretung". Um einen direkten Kontakt mit dem Laserstrahl zu vermeiden darf das Gerät nicht geöffnet werden.

ADVERSEL: USYNLIG  
LASERSTRÅLING VED  
ÅBNING, NÅR  
SIKKERHEDSAF-BRYDER  
ER UDE AF FUNKTION.  
UNDGÅ UDSÆTTSELSE FOR  
STRÅLING

**ADVARSEL:** Denne mærkning er anbragt udvendigt på apparatet og indikerer, at apparatet arbejder med laserstråler af klasse 1, hvilket betyder, at der anvendes laserstråler af svageste klasse, og at man ikke på apparatets yderside kan bilve udsat for utilladellig kraftig stråling.

APPARATET BOR KUN ÅBNES AF  
FAGFOLK MED SÆRLIGT KENDSKAB  
TIL APPARATER MED LASERSTRÅLER!

Indvendigt i apparatet er anbragt den her gengivne advarselsmærkning, som advarer imod at foretage sådanne indgreb i apparatet, at man kan komme til at udsatte sig for laserstråling.

**OBS!** Apparaten innehåller laserkomponent som avger laserstråning överstigande gränsen för laserklass 1.

**VAROITUS.** Suojakoteloja si saa avata. Laite sisältää laserdiodin, joka lähettää näkymätöntä silmilie vaarallista lasersäteilyä.

**CAUTION:** USE OF CONTROLS OR ADJUSTMENTS OR PERFORMANCE OF PROCEDURES OTHER THAN THOSE SPECIFIED IN THE OWNER'S MANUAL MAY RESULT IN HAZARDOUS RADIATION EXPOSURE.

**VORSICHT:** DIE VERWENDUNG VON ANDEREN STEURUNGEN ODER EINSTELLUNGEN ODER DAS DURCHFÜHREN VON ANDEREN VORGÄNGEN ALS IN DER BEDIENUNGSANLEITUNG BESCHRIEBEN KÖNNEN GEFÄHRLICHE STRAHLENEXPOSITIONEN ZUR FOLGE HABEN.

## Important Notice

Copyrighted works including, but not limited to music, video, computer program, databases are protected by copyright laws. Unless specifically permitted under applicable copyright laws, you cannot copy, modify, assign, transmit or otherwise dispose of any copyrighted work with the consent of the owner of the copyright. Please take notice that unauthorized copying, modification, assignment, transmission and disposition may be subject to claims for damages and penalties.

- Avoid using a telephone (other than a cordless type) during an electrical storm. There may be a remote risk of electric shock from lightning.
- Do not use the telephone to report a gas leak in the vicinity of the leak.
- Use only the power cord indicated in this manual.
- Replace only with the same or equivalent type battery recommended by the manufacturer.
- Dispose of used batteries according to the manufacturer's instructions.



*Use only the battery pack that came with the computer or an optional battery pack. Use of wrong battery could damage your computer.*

TOSHIBA assumes no liability for any damage in such case.





## General Precautions

TOSHIBA computers are designed to optimize safety, minimize strain and withstand the rigors of portability. However, certain precautions should be observed to further reduce the risk of personal injury or damage to the computer.

Be certain to read the general precautions below and to note the cautions included in the text of the manual.

### Creating a computer-friendly environment

Place the computer on a flat surface that is large enough for the computer and any other items you are using, such as a printer.

Leave enough space around the computer and other equipment to provide adequate ventilation. Otherwise, they may overheat.

To keep your computer in prime operating condition, protect your work area from:

- Dust, moisture, and direct sunlight.
- Equipment that generates a strong electromagnetic field, such as stereo speakers (other than speakers that are connected to the computer) or speakerphones.
- Rapid changes in temperature or humidity and sources of temperature change such as air conditioner vents or heaters.
- Extreme heat, cold, or humidity.
- Liquids and corrosive chemicals.

### Stress injury

Carefully read the *Instruction Manual for Safety and Comfort*. It contains information on the prevention of stress injuries to your hands and wrists that can be caused by extensive keyboard use. Chapter 3, [Getting Started](#), also includes information on work space design, posture and lighting that can help reduce physical stress.

## Heat injury

- Avoid prolonged physical contact with the computer. If the computer is used for long periods, its surface can become very warm. While the temperature will not feel hot to the touch, if you maintain physical contact with the computer for a long time, for example if you rest the computer on your lap or if you keep your hands on the palm rest, your skin might suffer a low-heat injury.
- If the computer has been used for a long time, avoid direct contact with the metal plate supporting the various interface ports as this can become hot.
- The surface of the AC adaptor can become hot when in use but this condition does not indicate a malfunction. If you need to transport the AC adaptor, you should disconnect it and let it cool before moving it.
- Do not lay the AC adaptor on a material that is sensitive to heat as the material could become damaged.

## Pressure or impact damage

Do not apply heavy pressure to the computer or subject it to any form of strong impact as this can damage the computer's components or otherwise cause it to malfunction.

## ExpressCard overheating

Some PC and ExpressCards can become hot during prolonged use which may result in errors or instability in the operation of the device in question. In addition, you should also be careful when you remove a PC or ExpressCard that has been used for a long time.

## Mobile phones

Please be aware that the use of mobile phones can interfere with the audio system. The operation of the computer will not be impaired in any way, but it is recommended that a minimum distance of 30cm is maintained between the computer and a mobile phone that is in use.

## Instruction Manual for Safety and Comfort

All important information on the safe and proper use of this computer is described in the enclosed Instruction Manual for Safety and Comfort. Be sure to read it before using the computer.

## Table of Contents

### Preface

<b>Manual contents</b> .....	<b>xxxiii</b>
<b>Conventions</b> .....	<b>xxxiv</b>
Abbreviations .....	xxxiv
Icons .....	xxxiv
Keys .....	xxxiv
Key operation .....	xxxv
Display .....	xxxv
Messages .....	xxxv

### Chapter 1 Introduction

<b>Equipment checklist</b> .....	<b>1-1</b>
Hardware .....	1-1
Software .....	1-2
<b>Features</b> .....	<b>1-3</b>
<b>Special features</b> .....	<b>1-12</b>
<b>TOSHIBA Value Added Package</b> .....	<b>1-14</b>
<b>Utilities and Applications</b> .....	<b>1-15</b>
<b>Options</b> .....	<b>1-18</b>

### Chapter 2 The Grand Tour

<b>Front with the display closed</b> .....	<b>2-1</b>
<b>Left side</b> .....	<b>2-3</b>
<b>Right side</b> .....	<b>2-4</b>
<b>Backside</b> .....	<b>2-5</b>
<b>Underside</b> .....	<b>2-6</b>
<b>Front with the display open</b> .....	<b>2-7</b>
<b>Optical Disc Drive</b> .....	<b>2-9</b>
Region codes for DVD drive and media .....	2-9
About the HD DVD .....	2-10
Writable discs .....	2-11

CDs	2-11
DVDs	2-11
HD DVDs (supported by HD DVD-RW drive only)	2-11
DVD Super Multi drive (Supporting DVD±R DL)	2-12
HD DVD ROM drive	2-12
HD DVD-RW drive	2-13
<b>AC adaptor</b>	<b>2-14</b>
<b>Remote controller</b>	<b>2-15</b>
Using the remote controller	2-17
Installing/Removing batteries	2-19
Placing slim size remote controller	2-21

**Chapter 3 Getting Started**

<b>Installing the battery pack</b>	<b>3-2</b>
<b>Connecting the AC adaptor</b>	<b>3-3</b>
<b>Opening the display</b>	<b>3-4</b>
<b>Turning on the power</b>	<b>3-5</b>
<b>Windows Vista™ setup</b>	<b>3-5</b>
<b>Turning off the power</b>	<b>3-6</b>
Shut Down mode (Boot mode)	3-6
Sleep Mode	3-6
Hibernation Mode	3-8
<b>Restarting the computer</b>	<b>3-9</b>
<b>System Recovery Options</b>	<b>3-9</b>
System Recovery Options	3-10
<b>Restoring the preinstalled software from the Recovery HDD</b>	<b>3-10</b>
<b>Restoring the preinstalled software from Recovery Media</b>	<b>3-11</b>

**Chapter 4 Operating Basics**

<b>Using the TouchPad</b>	<b>4-1</b>
<b>Using the fingerprint sensor</b>	<b>4-2</b>
How to swipe the finger	4-3
Points to note about the fingerprint sensor	4-4
How to delete the fingerprint data	4-5
Fingerprint sensor limitations	4-5
Points to note about the fingerprint utility	4-6
Set up procedure	4-6
Windows logon via fingerprint authentication	4-7
Fingerprint system boot authentication	4-7
Fingerprint Single Sign-On feature	4-8
<b>USB Sleep and Charge function</b>	<b>4-9</b>
How to enable/disable USB sleep and charge function	4-10
<b>Using the Web Camera</b>	<b>4-11</b>
Using the software	4-11

<b>Using the microphone</b> .....	<b>4-12</b>
<b>Using the optical disc drive</b> .....	<b>4-13</b>
Loading discs .....	4-13
Removing discs .....	4-16
<b>Writing CD/DVD with the DVD Super Multi drive or HD DVD-ROM drive supporting DVD±R DL</b> .....	<b>4-17</b>
Important message (DVD Super Multi drive or HD DVD-ROM drive supporting DVD±R DL) .....	4-17
Before writing or rewriting .....	4-18
When writing or rewriting .....	4-20
Disclaimer (DVD Super Multi drive or HD DVD-ROM drive supporting DVD±R DL) .....	4-20
<b>Writing CD/DVD/HD DVDs on HD DVD-RW drives</b> .....	<b>4-21</b>
Important message .....	4-21
Legal Footnotes .....	4-22
Before writing or rewriting .....	4-22
When writing or rewriting .....	4-25
<b>TOSHIBA Disc Creator</b> .....	<b>4-26</b>
<b>Data Verification</b> .....	<b>4-27</b>
How to learn more about TOSHIBA Disc Creator .....	4-27
<b>Video</b> .....	<b>4-27</b>
<b>When using Ulead DVD MovieFactory® for TOSHIBA:</b> .....	<b>4-28</b>
How to make a Labelflash DVD .....	4-28
<b>When Using Ulead MediaFactory for TOSHIBA</b> .....	<b>4-28</b>
How to make a DVD-Video .....	4-28
How to learn more about Ulead MediaFactory .....	4-29
Important information for use .....	4-29
<b>Media care</b> .....	<b>4-30</b>
CD/DVD/HD DVD .....	4-30
<b>Modem</b> .....	<b>4-31</b>
Region selection .....	4-31
Properties menu .....	4-32
Settings .....	4-32
Modem Selection .....	4-32
Dialing Properties .....	4-32
Connecting .....	4-33
Disconnecting .....	4-33
<b>Using the FM tuner</b> .....	<b>4-34</b>
<b>Wireless communications</b> .....	<b>4-34</b>
Wireless LAN .....	4-35
Security .....	4-35
Bluetooth Stack for Windows by TOSHIBA (depends on the model purchased) .....	4-35

Wireless communication switch	4-36
Wireless activity LED	4-36
<b>LAN</b>	<b>4-37</b>
LAN cable types	4-37
Connecting LAN cable	4-37
Disconnecting LAN cable	4-38
<b>Cleaning the computer</b>	<b>4-38</b>
<b>Moving the computer</b>	<b>4-39</b>

*Chapter 5* **The Keyboard**

<b>Typewriter keys</b>	<b>5-1</b>
<b>F1 ... F12 function keys</b>	<b>5-2</b>
<b>Soft keys: Fn key combinations</b>	<b>5-2</b>
Emulating keys on enhanced keyboard	5-2
<b>Hot keys</b>	<b>5-3</b>
Fn Sticky key (Depends on the model you purchased)	5-5
<b>Windows® special keys</b>	<b>5-5</b>
<b>Keypad overlay</b>	<b>5-6</b>
Turning on the overlays	5-6
Temporarily using normal keyboard (overlay on)	5-7
<b>Generating ASCII characters</b>	<b>5-7</b>

*Chapter 6* **Power and Power-Up Modes**

<b>Power conditions</b>	<b>6-1</b>
<b>Power indicators</b>	<b>6-2</b>
Battery indicator	6-2
Power indicator	6-2
<b>Battery types</b>	<b>6-4</b>
Battery pack	6-4
Real Time Clock battery	6-5
<b>Care and use of the battery pack</b>	<b>6-6</b>
Safety precautions	6-6
Charging the batteries	6-8
Monitoring battery capacity	6-10
Maximizing battery operating time	6-10
Retaining data with power off	6-11
Extending battery life	6-11
<b>Replacing the battery pack</b>	<b>6-12</b>
Removing the battery pack	6-12
Installing the battery pack	6-13
<b>Starting the computer by password</b>	<b>6-13</b>
<b>Power-up modes</b>	<b>6-14</b>
Hot keys	6-14
<b>Panel power off/on</b>	<b>6-14</b>

	<b>System Auto Off</b> .....	<b>6-14</b>
<i>Chapter 7</i>	<b>HW Setup</b>	
	<b>Accessing HW Setup</b> .....	<b>7-1</b>
	<b>HW Setup Window</b> .....	<b>7-1</b>
<i>Chapter 8</i>	<b>Optional Devices</b>	
	<b>ExpressCard</b> .....	<b>8-2</b>
	Inserting an ExpressCard .....	8-2
	Removing an ExpressCard .....	8-3
	<b>SD/SDHC/MMC/MEMORY STICK / MEMORY STICK PRO/xD</b>	
	<b>Memory cards</b> .....	<b>8-4</b>
	Installing a memory card .....	8-5
	Removing a memory card .....	8-5
	Memory card care .....	8-6
	<b>Memory expansion</b> .....	<b>8-7</b>
	Installing a memory module .....	8-7
	Removing a memory module .....	8-9
	<b>Additional battery pack</b> .....	<b>8-10</b>
	<b>Additional AC adaptor</b> .....	<b>8-10</b>
	<b>External monitor</b> .....	<b>8-11</b>
	<b>Television</b> .....	<b>8-11</b>
	<b>HDMI</b> .....	<b>8-12</b>
	Setting for display video on HDMI .....	8-12
	Settings for audio on HDMI .....	8-12
	<b>i.LINK (IEEE1394)</b> .....	<b>8-13</b>
	Precautions .....	8-13
	Connecting .....	8-14
	Disconnecting .....	8-14
	<b>Security lock</b> .....	<b>8-15</b>
<i>Chapter 9</i>	<b>Troubleshooting</b>	
	<b>Problem solving process</b> .....	<b>9-1</b>
	Preliminary checklist .....	9-2
	Analyzing the problem .....	9-2
	<b>Hardware and system checklist</b> .....	<b>9-3</b>
	System start-up .....	9-3
	Self test .....	9-4
	Power .....	9-4
	Disposing of PC and PC batteries .....	9-6
	Real Time Clock .....	9-7
	Keyboard .....	9-7
	LCD panel .....	9-8
	Hard disk drive .....	9-8
	DVD Super Multi drive (Supporting DVD±R DL) .....	9-9

HD DVD ROM drive . . . . .	9-10
HD DVD-RW drive . . . . .	9-12
Pointing device . . . . .	9-14
USB . . . . .	9-16
USB Sleep and Charge function. . . . .	9-17
Memory expansion . . . . .	9-18
Sound system . . . . .	9-19
Monitor . . . . .	9-19
Modem . . . . .	9-19
LAN. . . . .	9-20
Wireless LAN . . . . .	9-20
Fingerprint sensor. . . . .	9-21
ExpressCard. . . . .	9-21
<b>TOSHIBA support. . . . .</b>	<b>9-22</b>
Before you call . . . . .	9-22
Where to write . . . . .	9-22

*Appendix A* **Specifications**

*Appendix B* **Display Controller and Modes**

*Appendix C* **Wireless LAN**

*Appendix D* **AC Power Cord and Connectors**

*Appendix E* **Legal Footnotes**

**Glossary**

**Index**



## Preface

Congratulations on your purchase of the TOSHIBA Satellite A300/A300D, Satellite Pro A300/A300D Series computer. This powerful notebook computer provides excellent expansion capability, including multimedia devices, and it is designed to provide years of reliable, high-performance computing.

This manual tells how to set up and begin using your TOSHIBA Satellite A300/A300D, Satellite Pro A300/A300D Series computer. It also provides detailed information on configuring your computer, basic operations and care, using optional devices and troubleshooting.

If you are a new user of computers or if you're new to portable computing, first read over the *Introduction* and *The Grand Tour* chapters to familiarize yourself with the computer's features, components and accessory devices. Then read *Getting Started* for step-by-step instructions on setting up your computer.

If you are an experienced computer user, please continue reading the preface to learn how this manual is organized, then become acquainted with this manual by browsing through its pages. Be sure to look over the *Specifications* section of the Introduction, to learn about features that are uncommon or unique to the computer. If you are going to install ExpressCards or connect external devices such as a monitor, be sure to read Chapter 8, *Optional Devices*.

## Manual contents

This manual is composed of the following nine chapters, five appendixes, a glossary and an index.

Chapter 1, *Introduction*, is an overview of the computer's features, capabilities, and options.

Chapter 2, *The Grand Tour*, identifies the components of the computer and briefly explains how they function.

Chapter 3, *Getting Started*, provides a quick overview of how to begin operating your computer and gives tips on safety and designing your work area.

Chapter 4, *Operating Basics*, includes instructions on using the following devices: TouchPad, Sound System, optical media drives, modem, wireless communication and LAN. It also provides tips on care of the computer, and CD/DVDs.

Chapter 5, *The Keyboard*, describes special keyboard functions including the keypad overlay and hot keys.

Chapter 6, *Power and Power-Up Modes*, gives details on the computer's power resources and battery save modes.

Chapter 7, *HW Setup* explains how to configure the computer using the HW Setup program.

Chapter 8, *Optional Devices*, describes the optional hardware available.

Chapter 9, *Troubleshooting*, provides helpful information on how to perform some diagnostic tests, and suggests courses of action if the computer doesn't seem to be working properly.

The *Appendices* provide technical information about your computer.

The *Glossary* defines general computer terminology and includes a list of acronyms used in the text.

The *Index* quickly directs you to the information contained in this manual.

## Conventions

This manual uses the following formats to describe, identify, and highlight terms and operating procedures.

### Abbreviations

On first appearance, and whenever necessary for clarity, abbreviations are enclosed in parentheses following their definition. For example: Read Only Memory (ROM). Acronyms are also defined in the Glossary.

### Icons

Icons identify ports, dials, and other parts of your computer. The indicator panel also uses icons to identify the components it is providing information on.

### Keys

The keyboard keys are used in the text to describe many computer operations. A distinctive typeface identifies the key top symbols as they appear on the keyboard. For example, **Enter** identifies the Enter key.

## Key operation

Some operations require you to simultaneously use two or more keys. We identify such operations by the key top symbols separated by a plus sign (+). For example, **Ctrl + C** means you must hold down **Ctrl** and at the same time press **C**. If three keys are used, hold down the first two and at the same time press the third.

**ABC**

When procedures require an action such as clicking an icon or entering text, the icon's name or the text you are to type in is represented in the type face you see to the left.

## Display



**ABC**

Names of windows or icons or text generated by the computer that appears on its display screen is presented in the type face you see to the left.

## Messages

Messages are used in this manual to bring important information to your attention. Each type of message is identified as shown below.



*Pay attention! A caution informs you that improper use of equipment or failure to follow instructions may cause data loss or damage your equipment.*



*Please read. A note is a hint or advice that helps you make best use of your equipment.*



*Indicates a potentially hazardous situation, which could result in death or serious injury, if you do not follow instructions.*

## Terminology

This term is defined in this document as follows:

**Start**

The word "Start" refers to the  button in Microsoft® Windows Vista™.



# Chapter 1

## Introduction

This chapter provides an equipment checklist, and it identifies the computer's features, options and accessories.



*Some of the features described in this manual may not function properly if you use an operating system that was not pre-installed by TOSHIBA.*

## Equipment checklist

Carefully unpack your computer. Save the box and packing materials for future use.

### Hardware

Check to make sure you have all the following items:

- TOSHIBA Satellite A300/A300D, Satellite Pro A300/A300D Series Portable Personal Computer
- Universal AC adaptor and power cord



*It is necessary to install the battery to use this computer. Refer to Installing the battery pack section in Chapter 3, [Getting Started](#).*

## Software

### **Microsoft® Windows Vista™**

The following software is preinstalled:

- Microsoft® Windows Vista™
- Microsoft Internet Explorer
- TOSHIBA Value Added Package
- TOSHIBA Hardware Setup
- TOSHIBA Supervisor Password
- TOSHIBA Assist
- TOSHIBA ConfigFree
- TOSHIBA DVD PLAYER
- TOSHIBA HD DVD PLAYER (HD DVD model only)
- TOSHIBA FingerPrint Utility (FingerPrint support model only)
- TOSHIBA SD Memory Utilities
- TOSHIBA Disc Creator
- TOSHIBA Face Recognition
- TOSHIBA Acoustic Silencer
- Ulead MediaFactory® for TOSHIBA
- Presto! BizCard 5 (Provided with some models)
- Online Manual

Other software may be preinstalled dependant on the model purchased.

### **Documentation**

- TOSHIBA Satellite A300/A300D, Satellite Pro A300/A300D Series Personal Computer User Information Guide
- Microsoft® Windows Vista™ manual package (Provided with some models)
- International Limited Warranty (ILW) Instruction (This instruction is included only with computers sold in ILW supported areas.)



*If any of the items are missing or damaged, contact your dealer immediately.*

## Features

Please visit your region's web site for the configuration details of the model that you have purchased.

### **Processor**

<b>Built-in</b>	Depend on the model you purchased. Please visit your region's website for the configuration details of the model that you have purchased.
<b>Chipset</b>	Depend on the model you purchased. Mobile Intel® PM965/GM965/GL960 Express Chipset or AMD M690G Chipset

### **Memory**

<b>Slots</b>	PC2-5300(PM965/GM965/RS690M)/PC2-4200(GL960) 512 MB, 1024 MB or 2048 MB. Up to 2GB memory module can be installed in the memory slot for a maximum of 4GB (PM965/GM965/M690G), 2GB (GL960) system memory total, depending on the model you purchased.
<b>Main Memory Disclaimer</b>	Part of the main system memory may be used by the graphics system for graphics performance and therefore reduce the amount of main system memory available for other computing activities. The amount of main system memory allocated to support graphics may vary depending on the graphics system, applications utilized, system memory size and other factors. For PC's configured with 4 GB of system memory, the full system memory space for computing activities will be considerably less and will vary by model and system configuration.

---

**Video RAM**

Depending on the model you purchased.

Mobile Intel® GM965 Express Chipset/Mobile Intel® GL960 Express Chipset model:

Video RAM capacity shares with main memory, and the proportion depends on Dynamic Video Memory Technology.

Mobile Intel® GM965 Express Chipset/Mobile Intel® PM965 Express Chipset model in graphic chip by ATI Mobility Radeon™ HD 3470:

External 64/128/256 MB.

Mobile Intel® GM965 Express Chipset/Mobile Intel® PM965 Express Chipset model in graphic chip by ATI Mobility Radeon™ HD 3650:

External 256/512 MB.

AMD M690G Chipset Chipset model:

Video RAM capacity shares with main memory, and the proportion depends on ATI HyperMemory™.

AMD M690G Chipset model in graphic chip by ATI Mobility Radeon™ HD 3470:

External 64/128/256 MB.

AMD M690G Chipset model in graphic chip by ATI Mobility Radeon™ HD 3650:

External 256/512 MB.

---

**Power**

---

**Battery Pack**

Your computer is powered by a rechargeable lithium-ion battery pack.

---

**RTC Battery**

The internal RTC battery backs up the Real Time Clock and calendar.

---

**AC Adaptor**

The universal AC adaptor provides power to the system and recharges the batteries when they are low. It comes with a detachable power cord.

Because it is universal, it can receive a range of AC voltage from 100 to 240 volts; however, the output current varies among different models.

Using the wrong model can damage your computer. Refer to the *AC adaptor* section in Chapter 2, *The Grand Tour*.

---



## Disks

---

**Hard disk Disclaimer** 1 Gigabyte (GB) means  $10^9 = 1,000,000,000$  bytes using powers of 10. The computer operating system, however, reports storage capacity using powers of 2 for the definition of 1 GB =  $2^{30} = 1,073,741,824$  bytes, and therefore shows less storage capacity. Available storage capacity will also be less if the product includes one or more pre-installed operating systems, such as Microsoft Operating System and/or pre-installed software applications, or media content. Actual formatted capacity may vary.

---

**Hard disk Drive** Depend on the model you purchased.

- 120GB
- 160GB
- 200GB
- 250GB
- 320GB
- 400GB
- 500GB

Other hard disk drives may be introduced in the future.



*Computers in this series can be configured with a fixed optical media drive. The available optical media drives are described below.*

**DVD Super Multi drive (Supporting DVD±R DL)**

Some models are equipped with a full-size DVD Super Multi drive module that lets you record data to rewritable CD/DVDs as well as run either 12cm (4.72") or 8cm (3.15") CD/DVDs without using an adaptor. It reads DVD-ROM's at maximum 8 speed and CD-ROM's at maximum 24 speed. It writes CD-R's at up to 24 speed, CD-RW's at up to 16 speed, DVD-R's at maximum 8 speed, DVD-RW's at maximum 6 speed. DVD+R's at maximum 8 speed, DVD+RW's at maximum 8 speed, DVD+R(DL) discs at maximum 4 speed and DVD-R(DL) discs at maximum 4 speed.

DVD-RAM at maximum 5 speed.

- DVD-ROM
  - DVD-Video
  - DVD-R
  - DVD-RW
  - DVD+R
  - DVD+RW
  - DVD-RAM
  - DVD+R DL
  - DVD-R DL
  - CD-DA
  - CD-Text
  - Photo CD (single/multi-session)
  - CD-ROM Mode 1, Mode 2
  - CD-ROMXA Mode 2 (Form1, Form2)
  - Enhanced CD (CD-EXTRA)
  - CD-G (Audio CD only)
  - Addressing Method 2
-

---

**HD DVD-ROM**

Some models are equipped with a full-size HD DVDROM drive module that lets you run CD's or DVD's without using an adaptor. The drive reads DVD-ROM's at a maximum 8x speed and CD-ROM's at a maximum 24x speed, and HD DVD's at a maximum 1x speed and writes CD-R's at up to 16x speed, CD-RW's at up to 10x speed, DVD-R's and DVD+R's at up to 4x speed, DVDRW's and DVD+RW's at up to 4x speed, DVD-R (Dual layer) at up to 2x speed, DVD+R (Double Layer) at up to 2.4x speed and DVD-RAM at up to 3x speed, and supports the following formats:

- CD-R
  - CD-RW
  - DVD-ROM
  - DVD-Video
  - CD-DA
  - CD-Text
  - Photo CD. (single/multi-session)
  - CD-ROM Mode 1, Mode 2
  - CD-ROM XA Mode 2 (Form1, Form2)
  - Enhanced CD (CD-EXTRA)
  - Addressing Method 2
  - DVD-R
  - DVD-R (Dual Layer)
  - DVD-RW
  - DVD+R
  - DVD+R (Double Layer)
  - DVD+RW
  - DVD-RAM
  - HD DVD-ROM
-

**HD DVD-RW drive**

Some models are equipped with a full-size HD DVD-R drive module that lets you run CD's or DVD's without using an adaptor. The drive reads DVD-ROM's at a maximum 8x speed and CD-ROM's at a maximum 24x speed, and HD DVD's at a maximum 1x speed and writes CD-R's at up to 16x speed, CD-RW's at up to 4x speed, DVD-R's and DVD+R's at up to 4x speed, DVDRW's and DVD+RW's at up to 4x speed, DVD-R (Dual layer) at up to 2x speed, DVD+R (Double Layer) at up to 2.4x speed and DVD-RAM at up to 3x speed, HD DVD-R and HD DVD-RW at up to 1x speed, and supports the following formats:



- CD-R
  - CD-RW
  - DVD-ROM
  - DVD-Video
  - CD-DA
  - CD-Text
  - CD-DA
  - CD-Text
  - Photo CD. (single/multi-session)
  - CD-ROM Mode 1, Mode 2
  - CD-ROM Mode 1, Mode 2
  - CD-ROM XA Mode 2 (Form1, Form2)
  - Enhanced CD (CD-EXTRA)
  - Addressing Method 2
  - DVD-R
  - DVD-R (Dual Layer)
  - DVD-RW
  - DVD+R
  - DVD+R (Double Layer)
  - DVD+RW
  - DVD-RAM
  - HD DVD-ROM
  - HD DVD-R
  - HD DVD-RW
-

## Display

The computer's LCD panel supports high-resolution video graphics. The screen can be set at a wide range of viewing angles for maximum comfort and readability.

<b>Built-In</b>	15.4" WXGA 16 M colors, with the following resolution: 1280 horizontal × 800 vertical pixels
<b>Graphics Controller</b>	Graphics controller maximizes display performance. Refer to <a href="#">Display Controller and Modes</a> section in Appendix B, <a href="#">Display Controller and Modes</a> for more information.

## Keyboard

<b>Built-In</b>	TOSHIBA Vista keyboard, 86 keys or 87 keys, compatible with IBM enhanced keyboard, embedded numeric overlay, dedicated cursor control,  and  keys. Refer to Chapter 5, <a href="#">The Keyboard</a> , for details.
-----------------	--

## Pointing Device

<b>Built-In TouchPad</b>	A TouchPad and control buttons in the palm rest enable control of the on-screen pointer and scrolling of windows.
--------------------------	---

## Ports

<b>External Monitor</b>	This 15-pin port lets you connect an external video display.
<b>HDMI</b>	This HDMI jack allows you to connect external display/audio devices. (Provided with some models)
<b>Universal Serial Bus (USB 2.0)</b>	The computer has Universal Serial Bus ports that comply with the USB 2.0 standard, which enables data transfer speeds 40 times faster than the USB 1.1 standard. (The ports also support USB 1.1.
<b>i.LINK (IEEE1394a)</b>	This port enables high-speed data transfer directly from external devices such as digital video cameras.

---

<b>TV Out</b>	The 4-pin S-Video port is compatible with PAL or NTSC TV standard, supporting Macrovision 7.02 copy protection.
---------------	---

---

<b>Infrared receiver window</b>	This window receives signals from the remote control which is provided with your computer.
---------------------------------	--

---

### **Slots**

---

<b>ExpressCard</b>	The ExpressCard expansion slot that can accommodate two standard module formats; an ExpressCard/34 module and an ExpressCard/54 module. An ExpressCard module is a small add-in card technology based on the PCI Express and Universal Serial Bus (USB) interfaces.
--------------------	---

---

<b>Multiple Digital Media Card Slot</b>	Supports SD/SDHC memory card, MMC, MEMORY STICK, MEMORY STICK PRO and xD Picture card.
---	--

---

### **Multimedia**

---

<b>Web Camera</b>	Record/Send still or video images with this integrated webcam. (provided with some models)
-------------------	---

---

<b>Sound System</b>	A Windows® Sound System that provides speakers as well as jacks for an external microphone and headphones.
---------------------	--

---

<b>Headphone(S/P DIF) jack</b>	This jack outputs analog audio signals. This jack can be used also as S/P DIF jack and enables connection of optical digital correspondence apparatus.
--------------------------------	--

---

<b>Microphone Jack</b>	A 3.5 mm mini microphone jack enables connection of a three-conductor mini jack for monaural microphone input.
------------------------	--

---

---

## Communications

---

<b>Modem</b>	<p>The internal modem feature is not available on all models. Where present, it provides capability for data and fax communication. It supports V.90 (V.92). The speed of data transfer and fax communication depends on the analog telephone line conditions. The computer has a modem jack for connection to a telephone line. Both V.90 and V.92 are supported only in the USA, Canada. V.90 is available in other regions. (Provided with some models)</p>
<b>LAN</b>	<p>The computer is equipped with a LAN card that supports Fast Ethernet LAN (100 Mbit/s, 100BASE-TX) or Gigabit Ethernet LAN (1 Gbit/s, 1000BASE-T). It is preinstalled as a standard device in some markets. (depending on model you purchased)</p>
<b>Wireless LAN</b>	<p>Where present, it supports the A,B,G and draft N standards but it is compatible with other LAN systems based on Direct Sequence Spread Spectrum / Orthogonal Frequency Division Multiplexing radio technology that complies with the IEEE 802.11 Standard.</p> <ul style="list-style-type: none"><li>■ Automatic Transmit Rate Select mechanism in the transmit range of 54, 48, 36, 24, 18, 12, 9 and 6 Mbit/s. (IEEE 802.11a/g)</li><li>■ Automatic Transmit Rate Select mechanism in the transmit range of 11, 5.5, 2 and 1 Mbit/s. (IEEE 802.11b)</li><li>■ Roaming over multiple channels</li><li>■ Card Power Management</li><li>■ Wired Equivalent Privacy (WEP) data encryption, based on 128 bit encryption algorithm.</li><li>■ Advanced Encryption Standard (AES) data encryption, based on 128 bit encryption algorithm.</li></ul>
<b>Bluetooth</b>	<p>Some computers in this series are equipped with Bluetooth functions. Bluetooth wireless technology eliminates the need for cables between electronic devices such as computers and printers. Bluetooth provides fast, reliable, and secure wireless communication in a small space. (Provided with some models)</p>

---

---

<b>Wireless Communication Switch</b>	This switch turns the Wireless LAN and Bluetooth function on and off. (Provided with some models)
--------------------------------------	--

---

## Security

---

<b>Security lock slot</b>	Connects an optional security lock to anchor the computer to a desk or other large object.
<b>Password</b>	Power-on password protection HDD password protection Two level password architecture Fingerprint authentication (not available on all models)

---

## Special features

The following features are either unique to TOSHIBA computers or are advanced features, which make the computer more convenient to use.

---

<b>Hot Keys</b>	Key combinations let you quickly modify the system configuration directly from the keyboard without running a system configuration program.
<b>Keypad Overlay</b>	A ten-key pad is integrated into the keyboard. Refer to the <a href="#">Keypad overlay</a> section in Chapter 5, The Keyboard, for instructions on using the keypad overlay.
<b>Instant Security</b>	The hot key function <b>Fn + F1</b> blanks the screen and disables the computer, providing data security.
<b>Display Automatic Power Off *1</b>	This feature automatically cuts off power to the internal display when there is no keyboard input for a specified time. Power is restored when any key is pressed. This can be specified in the Power Options.
<b>HDD Automatic Power Off *1</b>	This feature automatically cuts off power to the hard disc drive when it is not accessed for a specified time. Power is restored when the hard disc is accessed. This can be specified in the Power Options.

---



<b>System Automatic Sleep Mode/ Hibernation</b> *1	<p>This feature automatically shuts down the system into Sleep Mode or Hibernation Mode when there is no input or hardware access for a specified time.</p> <p>This can be specified in the Power Options.</p>
<b>Intelligent Power Supply</b> *1	<p>A microprocessor in the computer's intelligent power supply detects the battery's charge and calculates the remaining battery capacity. It also protects electronic components from abnormal conditions, such as voltage overload from an AC adaptor.</p> <p>This can be specified in the Power Options.</p>
<b>Battery Save Mode</b> *1	<p>This feature lets you save battery power.</p> <p>This can be specified in the Power Options.</p>
<b>Panel Power On/Off</b> *1	<p>This feature turns power to the computer off when the display panel is closed and turns it back on when the panel is opened.</p> <p>This can be specified in the Power Options.</p>
<b>Low Battery Automatic Hibernation</b> *1	<p>When battery power is exhausted to the point that computer operation cannot be continued, the system automatically enters Hibernation Mode and shuts down.</p> <p>This can be specified in the Power Options.</p>
<b>Hibernation</b>	<p>This feature lets you turn off the power without exiting from your software. The contents of main memory are saved to the hard disk so that when you turn on the power again, you can continue working right where you left off. Refer to the <a href="#">Turning off the power</a> section in Chapter 3, <a href="#">Getting Started</a>, for details.</p>
<b>Sleep Mode</b>	<p>If you have to interrupt your work, you can turn off the power without exiting from your software. Data is maintained in the computer's main memory so that when you turn on the power again, you can continue working right where you left off.</p>



\*1 Click , **Control Panel, System and Maintenance**, and then click **Power Options**.

## TOSHIBA Value Added Package

This section describes the TOSHIBA Component features pre-installed on the computer.

<b>TOSHIBA Power Saver</b>	TOSHIBA Power Saver provides you with the features of more various power supply managements.
<b>TOSHIBA Zooming Utility</b>	This utility allows you to enlarge or reduce the icon size on the Windows Desktop, or the zoom factor associated with specific supported applications.
<b>TOSHIBA PC Diagnostic Tool</b>	The TOSHIBA PC Diagnostic Tool will display basic system configuration information and allow the functionality of some of the computer's built-in hardware devices to be tested.
<b>TOSHIBA Flash Cards</b>	This utility supports the following functions. <ul style="list-style-type: none"><li>■ Hot key function</li><li>■ TOSHIBA utility launcher function</li></ul>
<b>TOSHIBA Components Common Driver</b>	TOSHIBA Components Common Driver contains the module required for the utility which TOSHIBA offers.
<b>TOSHIBA Accessibility</b>	The TOSHIBA Accessibility utility provides support to movement impaired users when they need to use the TOSHIBA Hot-key functions. In use, the utility allows you to make the <b>Fn</b> key 'sticky', that is you can press it once, release it, and then press one of the ' <b>F</b> ' keys in order to access its specific function. When set, the <b>Fn</b> key will remain active until another key is pressed.
<b>TOSHIBA Button Support</b>	This utility controls the button operation of the computer. The starting application from the button can be changed.

## Utilities and Applications

This section describes pre-installed utilities and tells how to start them. For details on operations, refer to each utility's online manual, help files or readme.txt files.

<b>TOSHIBA Assist</b>	TOSHIBA Assist is a graphical user interface that provides easy access to help and services.
<b>HW Setup</b>	This program lets you customize your hardware settings according to the way you work with your computer and the peripherals you use. To start the utility, double click the <b>TOSHIBA Assist</b> on your desktop, select <b>OPTIMIZE</b> tab, and click <b>TOSHIBA Hardware Settings</b> .
<b>Power On Password</b>	<p>Two levels of password security, supervisor and user, are available to prevent unauthorized access to your computer.</p> <p>To register a supervisor password, double click the <b>TOSHIBA Assist</b> on your desktop select the <b>SECURE</b> tab and start the <b>Supervisor password</b> utility.</p> <p>To set a user password, select the <b>SECURE</b> tab on TOSHIBA Assist, then start the <b>User password</b> utility. On the <b>Password</b> tab you can register a user password.</p>
<b>TOSHIBA Disc Creator</b>	You can create discs in several formats including audio CDs that can be played on a standard stereo CD player and data discs to store the files and folders on your hard disk drive. This software can be used on a model with a CD-RW/DVD-ROM drive, DVD Super Multi drive, HD DVD drive.
<b>TOSHIBA DVD-RAM Utility</b>	<p>TOSHIBA DVD-RAM Utility has a Physical Format function and Write-Protect function to DVD-RAM.</p> <p>This utility is contained in the TOSHIBA Disc Creator setup module.</p> <p>To run TOSHIBA DVD-RAM Utility, click , select <b>All Programs, TOSHIBA, CD&amp;DVD Applications</b>, and then click <b>DVD-RAM Utility</b>.</p>

---

**CD/DVD Drive  
Acoustic Silencer**

This utility allows you to configure the read speed of CD drive. You can either configure Normal Mode, which operates the drive at its maximum speed for quick data access, or Quiet Mode, which runs at single speed for CD audio and which can lessen operational noise. It is ineffective in DVD.

---

**Ulead DVD  
MovieFactory® for  
TOSHIBA**

You can edit digital video and make a DVD-Video and support Label Flash function.



*The availability of Label Flash function depends on the model you purchased.*

---

**FingerPrint utility**

This product has a fingerprint utility installed for the purpose of enrolling and recognizing fingerprints. (depending on the model purchased.) By enrolling the ID and password to the fingerprint authentication device, it is no longer necessary to input the password from the keyboard. Just by swiping the finger against the fingerprint sensor, the following functions will be enabled:

- Log-on to Windows and access a security enabled homepage through IE (Internet Explorer).
- Files and folders can be encrypted/decrypted and third party access to them prevented.
- Disable the password-protected screensaver when returning from power-saving (Sleep) mode.
- System boot authentication and Single Touch Boot feature.
- Power on Security and Single Sign On feature.

---

**TOSHIBA DVD  
PLAYER**

The DVD PLAYER is used to play DVD Video. It has an on-screen interface and functions.

---

**TOSHIBA HD DVD  
PLAYER**

The HD DVD PLAYER is used to play HD DVD Video. It has an on-screen interface and functions. (Provided with some models)

---

---

<b>TOSHIBA ConfigFree</b>	<p>ConfigFree is a suite of utilities to allow easy control of communication device and network connections. ConfigFree also allows you to find communication problems and create profiles for easy switching between location and communication networks.</p> <p>To run ConfigFree, click , select <b>All Programs, TOSHIBA, Networking</b> and then click <b>ConfigFree</b>.</p>
<b>TOSHIBA Face Recognition</b>	<p>TOSHIBA Face Recognition uses a face verification library to verify the face data of users when they log in to Windows. If the verification is successful, the user will be logged into Windows automatically. The user can thus avoid having to enter a password or the like, which makes the login process easier.</p>
<b>Presto! BizCard 5</b>	<p>Presto! BizCard keeps track of names, companies, mailing addresses, phone/fax numbers, e-mail addresses, and more. Simply scan your business cards and Presto! BizCard automatically saves the data and image for each card. Different viewing modes are available for easy searching, editing, creating, and sorting. You can share information with desktop organizers, contact managers, personal information managers (PIMs), and personal digital assistants (PDAs). You can also print ID badges, mailing labels, and stickers.</p>
<b>Windows Mobility Center</b>	<p>This section describes the Windows Mobility Center. Mobility Center is a utility for accessing several mobile PC settings quickly in one window. A maximum of eight tiles are prepared as the operating system default. Two additional tiles are also added to your Mobility Center.</p> <p>Installing the "TOSHIBA Extended Tiles for Windows Mobility Center" package will add the following functions.</p> <ul style="list-style-type: none"><li data-bbox="520 1193 1037 1299">■ <b>Lock Computer:</b> Lock your computer without turning it off. This has the same function as the Lock button at the bottom of the right pane of the start menu.</li><li data-bbox="520 1310 1037 1385">■ <b>TOSHIBA Assist:</b> Open the TOSHIBA Assist if it is already installed in your computer.</li></ul>

---

## Options

You can add a number of options to make your computer even more powerful and convenient to use. Refer to Chapter 8 *Optional Devices*, for details. The following options are available:

---

<b>Memory expansion</b>	Two memory modules can be installed in this computer.
-------------------------	---

---



*Use only PC5300\* compatible DDRII memory modules. See your TOSHIBA dealer for details.*

*\* The availability of DDRII depends on the model you purchased.*

---

<b>Battery pack</b>	An additional battery pack can be purchased from your TOSHIBA dealer. Use it as a spare to increase your computer operating time.
---------------------	---

---

<b>AC Adaptor</b>	If you use your computer at more than one site frequently, it may be convenient to purchase an additional AC adaptor for each site so you will not have to carry the adaptor with you.
-------------------	--

---

## Chapter 2

### The Grand Tour

This chapter identifies the various components of your computer. Become familiar with each component before you operate the computer.

#### Front with the display closed

The following figure shows the computer's front with its display panel in the closed position.

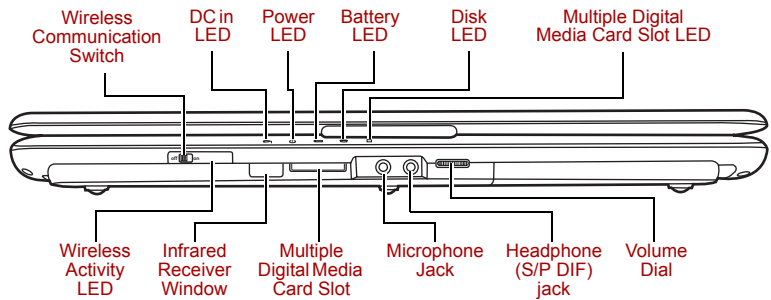

*Front of the computer with display closed*



#### Wireless Communication Switch

The Wireless Communication Switch turns on the wireless networking transceiver.



Set the switch to off in airplanes and hospitals. Check the wireless activity indicator. It will stop glowing when the wireless communication function is off.

	<b>DC IN LED</b>	The DC IN LED indicates the computer is connected to the AC adaptor and it is plugged into an AC power source.
	<b>Power LED</b>	The Power indicator glows blue when the computer is on. If you select Sleep Mode from Turn Off Computer, this indicator flashes orange (one second on, two seconds off) while the computer enters Sleep Mode.
	<b>Battery LED</b>	The Battery indicator shows the condition of the battery's charge: Blue indicates a full charge, orange indicates that the battery is charging and flashing orange indicates a low battery charge. Refer to Chapter 6, <i>Power and Power-Up Modes</i> .
	<b>Disk LED</b>	Disk LED indicates that the hard disk drive or optical disc drive is being accessed.
	<b>Multiple Digital Media Card Slot LED</b>	Multiple Digital Media Card Slot LED lights up when the Multiple Digital Media Card Slot is accessed. (Provided with some models)
	<b>Wireless Activity LED</b>	Indicates whether the wireless LAN or Bluetooth is active or not. (Provided with some models)
	<b>Infrared Receiver Window</b>	An infrared receiver window is provided with some models. This is a sensor window that receives signals from the remote control which is provided with your computer.
	<b>Multiple Digital Media Card Slot</b>	Supports SD/SDHC memory card, MMC, MEMORY STICK, MEMORY STICK PRO and xD Picture card.
	<b>Microphone Jack</b>	A 3.5 mm mini microphone jack enables connection of a three-conductor mini jack for monaural microphone input.
	<b>Headphone (S/P DIF) jack</b>	This jack outputs analog audio signals. This jack can be used also as S/P DIF jack and enables connection of optical digital correspondence apparatus.
	<b>Volume Dial</b>	Use this dial to adjust the volume of the stereo speakers or headphones.



## Left side

The following figure shows the computer's left side.

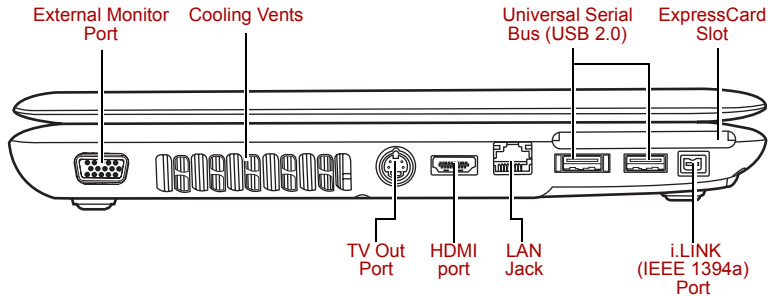

*The left side of the computer*



### External Monitor Port

This 15-pin port lets you connect an external video display.

### Cooling Vents

Cooling vents help prevent the CPU from overheating.



*Do not block the cooling vents. Also ensure that foreign objects are kept out of the vents as items such as pins or similar objects, which can damage the computer's circuitry.*



### Universal Serial Bus (USB 2.0)

Universal Serial Bus ports which comply to the USB 2.0 standard, are provided. The ports with the icon (⚡) has USB Sleep and Charge function.



### ExpressCard Slot

This slot allows you to insert an ExpressCard. An ExpressCard is a small, modular add-in card technology based on PCI Express and the Universal Serial Bus (USB) interface. The max. transmission rate is 2.5Gbps. ExpressCard/34 and ExpressCard/54 types are supported.



### TV Out Port

Connect a 4-pin S- video cable into this connector in order to output either an NTSC or PAL television signal.



### HDMI port

This port allows you to connect digitally to an HDTV or home theater receiver.



**LAN Jack** This jack lets you connect to a LAN. The adaptor has built-in support for Fast Ethernet LAN or Giga bit Ethernet. (Depend on the model you purchased). Refer to Chapter 4, *Operating Basics*, for details.



**i.LINK (IEEE1394a) Port** This port allows you to connect an external device, such as a digital video camera, for highspeed data transfer. (Provided with some models)

## Right side

The following figure shows the computer's right side.

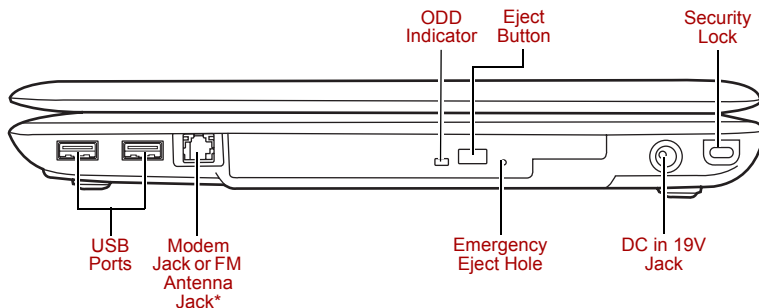

*The right side of the computer*

\* The figure shows Modem Jack.

**ODD Indicator** The ODD indicator glows amber when the computer accesses the optical disc drive.

**Eject Button** Press this button to open the ODD tray.



**Security Lock** A security cable attaches to this port. The optional security cable anchors your computer to a desk or other large object to deter theft.



**Universal Serial Bus (USB 2.0) ports** Universal Serial Bus port which comply to the USB 2.0 standard, are provided. The ports with the icon (⚡) has USB Sleep and Charge function.



### Modem Jack

The modem jack allows you to use a modular cable to connect the modem directly to a telephone line. (Depends on the model you purchased.)

- In case of a lightning storm, unplug the modem cable from the telephone jack.
- Do not connect the modem to a digital telephone line. A digital line will damage the modem.



### FM Antenna Jack

A jack enables the connection of FM antenna. (Depends on the model you purchased.)

### Emergency Eject Hole

In the event that the disc drive becomes inexplicably locked or stops responding press this button to force a manual ejection of the ODD tray.



### DC IN 19V Jack

The AC adaptor connects to this socket. Use only the model of AC adaptor that comes with the computer. Using the wrong adaptor can damage your computer.

## Backside

The following figure shows the computer's back panel.

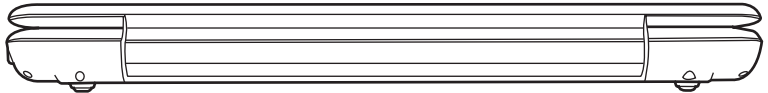



*The backside of the computer*

## Underside

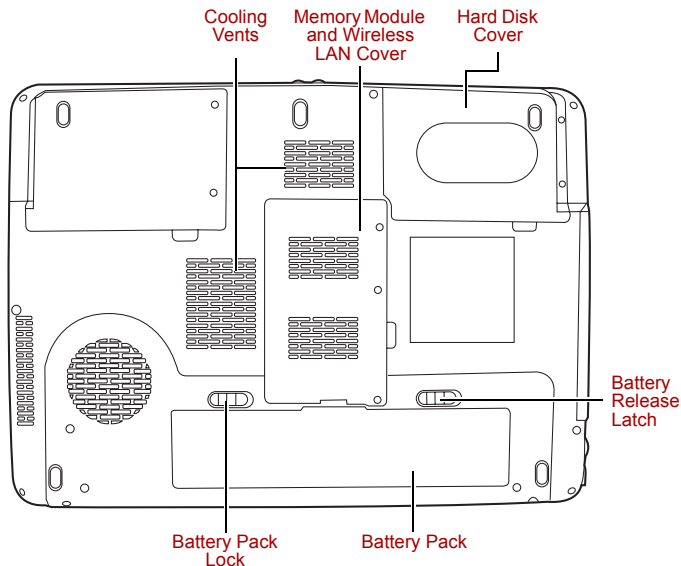
The following figure shows the underside of the computer. Make sure the display is closed before turning over your computer.



*The underside of the computer*

<p><b>Cooling Vents</b></p>	<p>Cooling vents help prevent the CPU from overheating.</p>
<p> <b>Memory Module and Wireless LAN Cover</b></p>	<p>This cover protects two memory module sockets -- one or two modules are pre-installed. Refer to the <a href="#">Memory expansion</a> section in Chapter 8, <i>Optional Devices</i>.</p>
<p><b>Hard Disk Cover</b></p>	<p>This cover protects the hard disk.</p>
<p> <b>Battery Pack Lock</b></p>	<p>Slide this lock to prepare the battery pack for removal.</p>
<p><b>Battery Pack</b></p>	<p>The battery pack powers the computer when the AC adaptor is not connected. For detailed information on the battery pack, refer to Chapter 6, <i>Power and Power-Up Modes</i>.</p>
<p> <b>Battery Release Latch</b></p>	<p>Slide and hold this latch to release the battery pack for removal. For detailed information on removing the battery pack, refer to Chapter 6, <i>Power and Power-Up Modes</i>.</p>

## Front with the display open

This section shows the front of the computer with the display open. Refer to the appropriate illustration for details. To open the display, lift the front of the display. Position the display at a comfortable viewing angle.

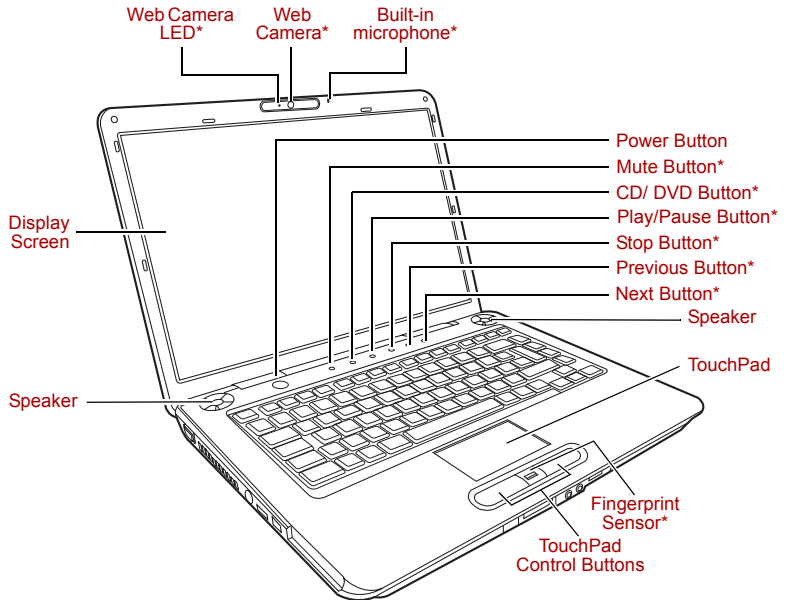

*The front of the computer with the display open*

\* Provided with some models



*Please handle your computer carefully to avoid scratching or damaging the surface.*

---

### Speakers

The speakers emit sound generated by your software as well as audio alarms, such as low battery condition, generated by the system.

---

### Display Screen







The LCD displays high-contrast text and graphics. Refer to Appendix B, [Display Controller and Modes](#). When the computer operates on the AC adaptor the display screen's image will be somewhat brighter than when it operates on battery power. The lower brightness level is intended to save battery power.

---

### Web Camera LED

Web Camera LED indicates web camera is working or not. (Provided with some models)

---

	<b>Web Camera</b>	Take your picture or send your image to web contacts. (Provided with some models)
	<b>Built-in microphone</b>	The Microphone is used with the Web Camera to talk to other Web Camera users and to record messages on windows media.
	<b>Power Button</b>	Turns the computer on and off and puts it into Hibernation mode and wakes it up from Sleep mode.
	<b>Mute Button</b>	Press this button to mute / un-mute sound.
	<b>CD/ DVD Button</b>	Pressing this button will launch an application program that allows for playing of CDs or DVDs. The application that is launched differs by model: Windows Media Player/TOSHIBA DVD PLAYER/TOSHIBA HD DVD PLAYER. (Provided with some models)
	<b>Play/Pause Button</b>	Press this button to begin playing an audio CD, a DVD movie or digital audio file. This button also acts as a Pause button. (Provided with some models)
	<b>Stop Button</b>	Stops playing of the CD, DVD or digital audio. (Provided with some models)
	<b>Previous Button</b>	Skips backwards to the previous track, chapter or digital file. Refer to Chapter 4, <i>Operating Basics</i> , for details. (Provided with some models)
	<b>Next Button</b>	Skips forward to the next track, chapter or digital file. Refer to Chapter 4, <i>Operating Basics</i> , for details. (Provided with some models)
	<b>TouchPad</b>	A TouchPad located in the centre of the palm rest is used to control the on-screen pointer.

<b>Fingerprint Sensor</b>	Just by swiping the finger against the fingerprint sensor, the following functions will be enabled: Log-on to Windows and access a security-enabled homepage through IE (Internet Explorer) Files and folders can be encrypted/decrypted and third party access to them prevented. Disable the password-protected screensaver when returning from power-saving (Sleep) mode. System boot authentication and Single Touch Boot feature. Authentication of the User Password and Hard Disk Drive Password when booting up the computer. Refer to the <a href="#">Using the fingerprint sensor</a> section in Chapter 4, <a href="#">Operating Basics</a> . (Provided with some models)
<b>TouchPad Control Buttons</b>	These let you select menu items or manipulate text and graphics designated by the on-screen pointer. Refer to the <a href="#">Using the TouchPad</a> section in Chapter 4, <a href="#">Operating Basics</a> .

## Optical Disc Drive

An ATAPI interface controller is used for optical disc operation. When the computer is accessing a optical disc, an indicator on the drive glows.

### Region codes for DVD drive and media

Optical disc drive and their associated media are manufactured according to the specifications of six marketing regions. When you purchase DVD-Video, make sure it matches your drive, otherwise it will not play properly.

Code	Region
1	Canada, United States
2	Japan, Europe, South Africa, Middle East
3	Southeast Asia, East Asia
4	Australia, New Zealand, Pacific Islands, Central America, South America, Caribbean
5	Russia, Indian Subcontinent, Africa, North Korea, Mongolia
6	China

## About the HD DVD

This section describes the features, use of HD DVD and HD DVD Media.

### Summary

HD DVD allows users to enjoy video, concerts and other packaged content by taking advantage of its large amount of storage space and high-quality audio and video. HD DVD also allows for the storage of long video when combined with the latest video compression technologies.

The storage capacity and data transfer rate of HD DVD is superior to standard DVD, with two types of playback-only discs in single-sided singlelayer 15 GB and single-sided dual-layer 30 GB (Gigabyte) formats.



- *Unfinalized DVDs created on home DVD recorders may not be playable on the computer.*
- *When inserting an unfinalized DVD-R DL disc into the computer, Windows Vista may automatically finalize the disc and prevent further writing.*

### Notes on use

- Because HD DVD is a new format there is a possibility of new features being added at a later date. As such, it is important that the purchaser understands that software and other updates may be necessary after purchase. Please be sure to complete user registration in order to receive timely product updates.
- This product can play existing DVD and CD formats, however, playback may not be possible with some software. This product cannot play Blu-ray DISC™ format software.
- HD DVD is a new standard which makes use of new technologies. As such, there is a possibility of problems occurring related to connection, compatibility or operation with some discs and other digital devices. The HD DVD-ROM logo signifies that this drive complies with the HD DVD physical standard, and does not signify compliance with the HD DVD Video standard. This device does not support advanced features of the HD DVD Video standard as defined by the DVD Forum, including picture-in-picture and network download features. Screen movement may not be smooth, and performance may be lowered with some HD DVD content.
- Playback of high bit rate content may cause frame dropping, audio skipping or decrease in computer performance.
- Viewing of HD DVD content on an external display requires a HDCP capable HDMI™ or DVI input on the external display.
- Make sure to connect the computer's AC adaptor when playing a HD DVD.
- CPU power is concentrated on HD DVD playback when playing a HD DVD, so make sure to exit all other applications.



- Dolby Digital audio enhancements are only supported by Microsoft® Windows® operating system. Content with high sample rates of 48kHz or more are downsampled when output through either the built-in speakers or headphone jack.
- This device supports AACS (Advanced Access Content System) nextgeneration copy protection technology. Renewal of the AACS key integrated into this device is required for uninterrupted enjoyment of HD DVD. An Internet connection is required when renewing the key.
- For more information on AACS keys, visit the AACS website ([www.aacsla.com/home](http://www.aacsla.com/home)).

## Writable discs

This section describes the types of writable CD discs. Check the specifications of your drive for the type of discs it can write. Refer to Chapter 4, *Operating Basics*.

### CDs

- CD-R discs can be written only once. The recorded data cannot be erased or changed.
- CD-RW discs can be recorded more than once. Use either 1, 2, or 4 multi speed CD-RW discs or high-speed 4- to 10-speed discs. The write speed of the ultra-speed CD-RW discs (Ultra-speed is available on the DVD-ROM & CD-R/RW drive only) is a maximum of 24-speed.

### DVDs

- DVD-R, DVD+R, DVD-R DL and DVD+R DL discs can be written only once. The recorded data cannot be erased or changed.
- DVD-RW, DVD+RW and DVD-RAM discs can be recorded more than once.

### HD DVDs (supported by HD DVD-RW drive only)

- HD DVD-R discs can be written only once. The recorded data cannot be erased or changed.
- HD DVD-RW discs can be recorded more than once.

## DVD Super Multi drive (Supporting DVD±R DL)

The full-size DVD Super Multi drive module lets you record data to writable CD/DVDs as well as run either 12 cm (4.72") or 8 cm (3.15") CD/DVDs without using an adaptor.



*The read speed is slower at the centre of a disc and faster at the outer edge.*

<b>DVD read</b>	8 speed (maximum)
<b>DVD-R write</b>	8 speed (maximum)
<b>DVD-RW write</b>	6 speed (maximum)
<b>DVD+R write</b>	8 speed (maximum)
<b>DVD+RW write</b>	8 speed (maximum)
<b>DVD-R(DL) write</b>	4 speed (maximum)
<b>DVD+R(DL) write</b>	4 speed (maximum)
<b>DVD-RAM write</b>	5 speed (maximum)
<b>CD read</b>	24 speed (maximum)
<b>CD-R write</b>	24 speed (maximum)
<b>CD-RW write</b>	16 speed (maximum, Ultra-speed media)

## HD DVD ROM drive

The full-size HD DVD ROM drive module lets you record data to s as rewritable CDs as well as run either 12 cm (4.72") HD DVD, 12 cm (4.72") or 8 cm (3.15") CD/DVDs without using an adaptor.



*The read speed is slower at the center of a disc and faster at the outer edge.*

<b>CD read</b>	24 speed (maximum)
<b>DVD read</b>	8 speed (maximum)
<b>HD DVD read</b>	1 speed (maximum)
<b>DVD-R write</b>	4 speed (maximum)
<b>DVD-R DL write</b>	2 speed (maximum)
<b>DVD-RW write</b>	4 speed (maximum)
<b>DVD+R write</b>	4 speed (maximum)
<b>DVD+R DL write</b>	2.4 speed (maximum)
<b>DVD+RW write</b>	4 speed (maximum)
<b>DVD-RAM write</b>	3 speed (maximum)
<b>CD-R write</b>	16 speed (maximum)
<b>CD-RW write</b>	10 speed (maximum, ultra-speed media)

## HD DVD-RW drive

The full-size HD DVD-RW drive module lets you record data to s as rewritable CDs as well as run either 12 cm (4.72") HD DVD, 12 cm (4.72") or 8 cm (3.15") CD/DVDs without using an adaptor.



*The read speed is slower at the center of a disc and faster at the outer edge.*

<b>CD read</b>	24 speed (maximum)
<b>DVD read</b>	8 speed (maximum)
<b>HD DVD read</b>	1 speed (maximum)
<b>HD DVD-R write</b>	1 speed (maximum)
<b>HD DVD-R DL write</b>	1 speed (maximum)
<b>HD DVD-RW write</b>	1 speed (maximum)
<b>DVD-R write</b>	4 speed (maximum)
<b>DVD-RW write</b>	4 speed (maximum)
<b>DVD+R write</b>	4 speed (maximum)
<b>DVD+RW write</b>	4 speed (maximum)
<b>DVD+R DL write</b>	2.4 speed (maximum)
<b>DVD-R DL write</b>	2 speed (maximum)
<b>DVD-RAM write</b>	3 speed (maximum)
<b>CD-R write</b>	16 speed (maximum)
<b>CD-RW write</b>	10 speed (maximum, ultra-speed media)

## AC adaptor

The AC adaptor converts AC power to DC power and reduces the voltage supplied to the computer. It can automatically adjust to any voltage from 100 to 240 volts and to a frequency of either 50 or 60 hertz, enabling you to use the computer in almost any country/region.

To recharge the battery, simply connect the AC adaptor to a power source and the computer. Refer to Chapter 6, *Power and Power-Up Modes*, for details.

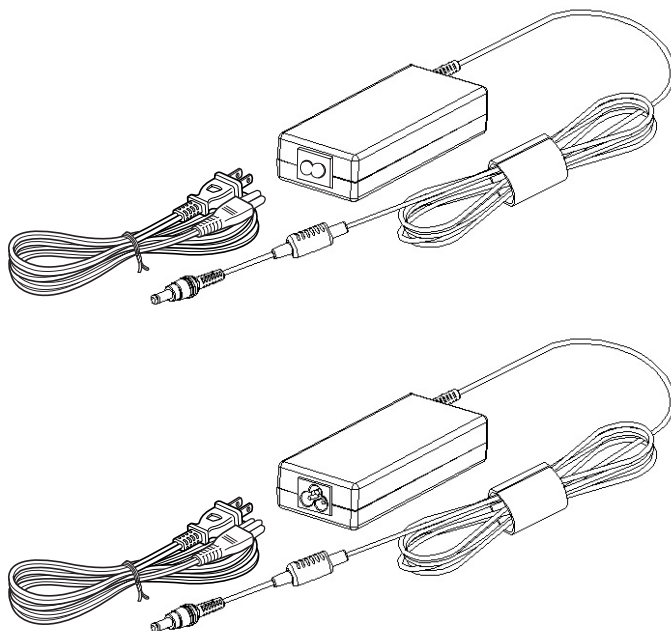

*The AC adaptor*



- *Use only the AC adaptor that came with the computer or an equivalent optional adaptor. Use of the wrong adaptor could damage your computer. TOSHIBA assumes no liability for any damage in such case.*
- *Use only the AC Adaptor supplied with your computer or an equivalent adaptor that is compatible. Use of any incompatible adaptor or other types of AC Adaptors may have a different voltage which could cause damage to your computer, computer failure and/or possible data loss. TOSHIBA assumes no liability for any damage, computer failure and/or data loss caused by use of an incompatible adaptor.*



*Use only the AC adaptor supplied as an accessory. Other AC adaptors have different voltage and terminal polarities and use of them may produce heat and smoke or even result in fire or rupture.*

## Remote controller

A remote controller, which is provided with some models, enables you to perform some functions of your computer from a distant location.

You can use your remote controller with Media Center to play CDs, DVDs and videos, to view pictures.

The remote controller helps you to control the playback of a movie through Media Center.

Using the remote controller, you can:

- Navigate and control all Media Center windows.
- Control the video.
- Place the computer in and out of Sleep mode.

### *Slim size remote controller*

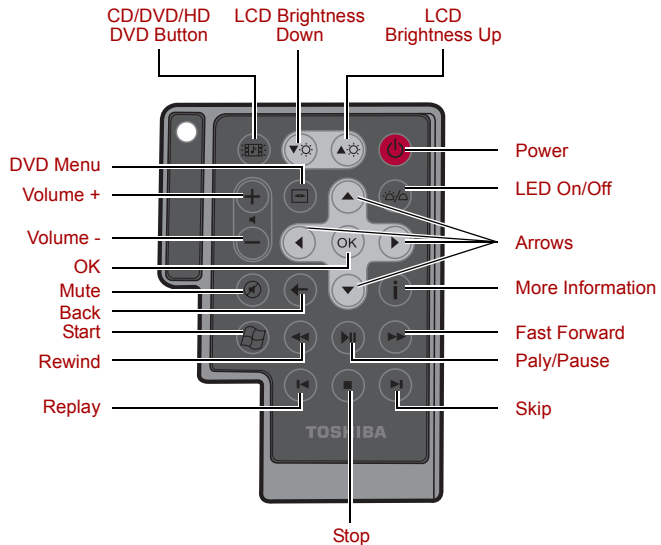

#### **CD/DVD/HD DVD button**



Press this button to launch an application program that allows Windows Media Player / DVD Video Player / HD DVD Video Player.

#### **Brightness down**















Decreases the computer's display panel brightness in individual steps.

#### **Brightness up**



Increases the computer's display panel brightness in individual steps.

<b>Power</b> 	<p>Starts or terminate the operating system. This button functions like the power button of your computer. By default, the Sleep mode is equivalent to the power off state of your computer. To change the setting, click <b>Start</b> → <b>Control panel</b> → <b>System and Maintenance</b> → <b>Power Options</b> → <b>Choose what the Power button does</b>. The following four options are available: Do nothing, Sleep, Hibernate and Shut down.</p>
<b>Volume +</b>	<p>Increases the volume while viewing DVDs or replaying CDs.</p>
<b>Volume -</b>	<p>Decreases the volume while viewing DVDs or replaying CDs.</p>
<b>DVD menu</b> 	<p>Opens the main menu on a DVD movie, if available.</p>
<b>Arrows</b>	<p>Moves the cursor to navigate within Media Center windows.</p>
<b>OK</b> <b>OK</b>	<p>Selects the desired action or window option. It acts like the <b>ENTER</b> Key.</p>
<b>LED on/off</b> 	<p>Pressing this button to switch the lighting of indicators.</p>
<b>Mute</b> 	<p>Turns your computer sound off.</p>
<b>Back</b> 	<p>Displays the previous window.</p>
<b>More information</b> <b>i</b>	<p>The button provides more detail information.</p>
<b>Start</b> 	<p>Opens Media Center to the main window.</p>
<b>Rewind</b> 	<p>Moves the media (video, DVD, music, and so on) backwards.</p>
<b>Play/Pause</b> 	<p>Plays the selected media. This button also acts as a pause button.</p>

<b>Fast forward</b> 	Moves the media (video, DVD, music, and so on) forwards.
<b>Replay</b> 	Moves media backward (seven seconds for videos, one music track or one DVD chapter at a time).
<b>Stop</b> 	Stops the media currently playing.
<b>Skip</b> 	Moves media forward (30 seconds for videos , one music track or one DVD chapter).

## Using the remote controller

Some computers include a remote control unit, which allows you to control some of your computer's functions from a distant location.



- *The remote controller is designed specifically for this computer.*
- *Some application programs may not support remote control functions.*

### **Operational range of the remote controller**

Point the remote controller at your computer and press a button. The operational angle and distance are described below.

<b>Distance</b>	Within 5 meters from the infrared receiver window.
<b>Angle</b>	Within about 30 degrees horizontally and about 15degrees vertically of perpendicular to the infrared receiver window.

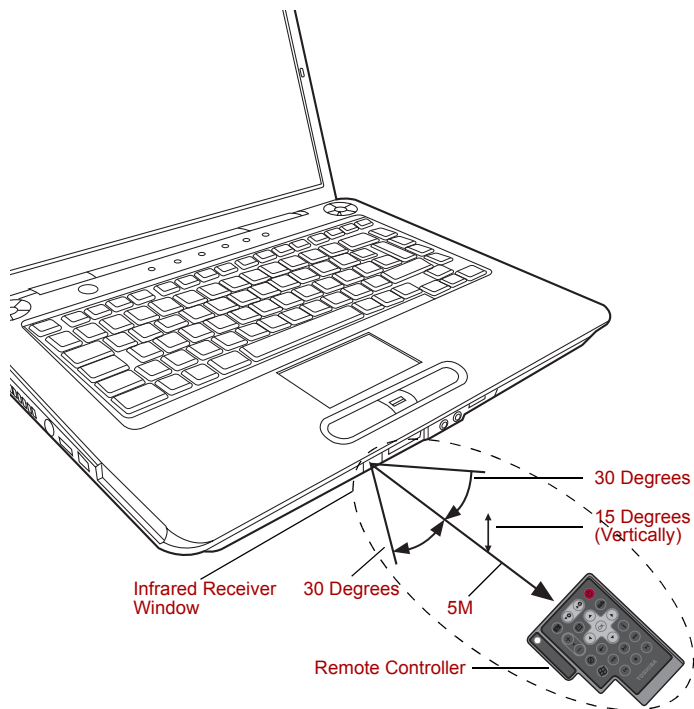

*Operational range of the remote controller*



*Even if within the effective scope as described above, the remote controller may malfunction or not work correctly in the following cases.*

- *When an obstacle stands between the infrared receiver window of your computer and the remote controller.*
- *When direct sunlight or strong fluorescent light strikes the infrared receiver window.*
- *When the infrared receiver window or the infrared emission part of the remote controller is dirty.*
- *When other computers which use an infrared remote controller are used near to your computer.*
- *When a low battery condition is present.*



## Installing/Removing batteries

Be sure to install the provided CR2016 type batteries before using the remote controller. The procedures for installing and removing the batteries vary depending on the type of the remote controller. Check the type and then install or remove the batteries as instructed.



*Store the battery for the remote controller beyond the reach of children. If a child swallows a battery, this might result in choking. If it happens, contact a doctor immediately.*



*Observe the following precautions when using the battery of the remote controller.*

- *Do not use batteries other than those specified.*
- *Ensure that you insert the batteries with their polarities correctly aligned (+ or -).*
- *Do not recharge, heat, disassemble or short the battery, or put it into a fire or flame.*
- *Do not use a battery whose “recommended expiration date” has been reached, or which is completely discharged.*
- *Do not use different types of batteries or old and new batteries at the same time.*
- *Do not carry the battery together with metal necklaces, hairpins or other metal accessories.*
- *When storing or disposing of used batteries, make sure to put some insulation tape on their terminals (+ and -) to avoid short-circuits.*

*If these precautions are not followed, heating, fluid leakage or explosion may occur. This may cause burns or personal injury. If battery fluid gets on your skin or clothes, wash immediately with clean water. If battery fluid gets in your eyes, rinse your eyes with clean water immediately and see a doctor. Do not touch the battery fluid on instruments or devices with bare hands. Wipe off with a cloth or paper towel.*

### **Type of battery that can be used for the remote controller**

When the provided batteries run down, please replace them with adequate ones. CR2016 type battery is available. Other types or battery should not be used.

### ***Installing the batteries***

1. Open the battery cover on the back side of the remote controller.

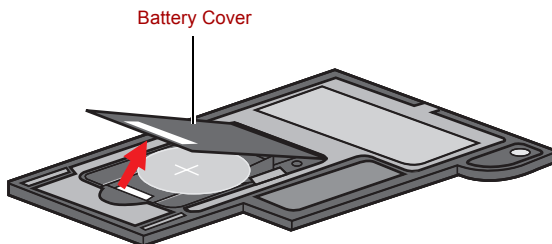

*Opening the battery cover*

2. Be sure to place the batteries with correct polarities. Press the battery down to the stopper then push it forward to fit into the battery case.

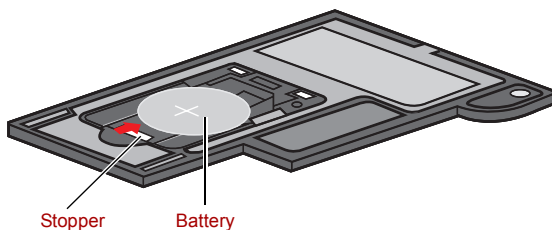

*Inserting the batteries*

3. Close the battery cover. Close the cover securely until it clicks.

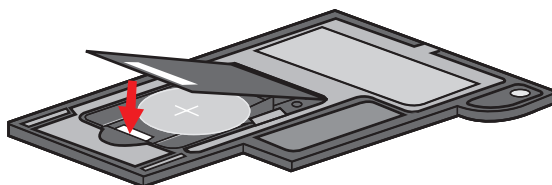

*Closing the battery cover*

### ***Replacing the batteries***

When the batteries in the remote controller reach the end of their life, the remote controller may not operate correctly or work only within a short distance from your computer. In this instance, you should purchase new batteries and replace the discharged ones.

### ***Slim size remote controller***

1. Open the battery cover on the back side of the remote controller.
2. Hold down the stopper and slide the battery out of battery case.

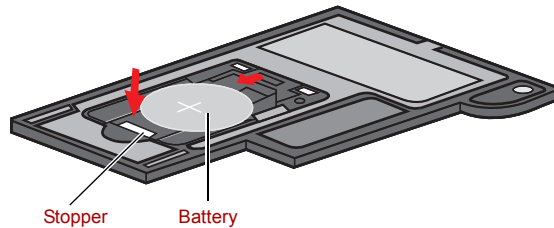

#### ***Removing the batteries***

3. Insert the battery in place. Be sure to place the batteries with correct polarities. Press the battery down to the stopper then push it forward to fit into the battery case.
4. Close the battery cover. Close the cover securely until it clicks.

## **Placing slim size remote controller**

### ***Inserting a slim size remote controller***

To insert the slim size remote controller, follow the steps below.

1. Make sure the ExpressCard slot is empty.
2. Set the front side upward and insert the slim size remote controller.

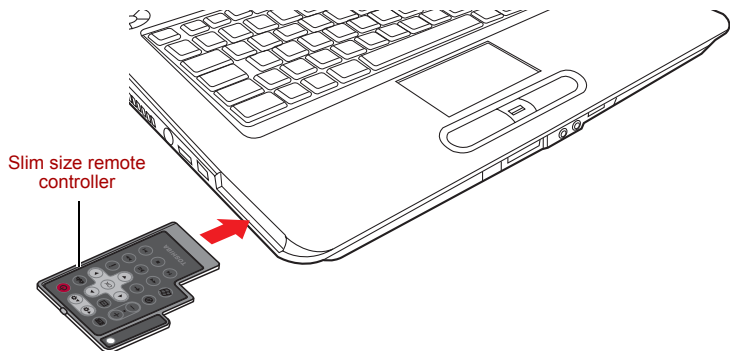

#### ***Inserting the slim size remote controller***

3. Press gently to ensure a firm connection.

### ***Remove a slim size remote controller***

To remove the slim size remote controller, follow the steps below.

1. Press the slim size remote controller slightly to make it stretch out.
2. Grasp the slim size remote controller and pull it out from the slot.



# Chapter 3

## Getting Started

This chapter provides basic information to get you started using your computer. It covers the following topics:



*Be sure also to read the Safety Instruction Manual. This guide, which is included with the computer, explains product liability.*

- Installing the battery pack
- Connecting the AC adaptor
- Opening the display
- Turning on the power
- Windows Vista™ setup
- Turning off the power
- Restarting the computer
- System Recovery Options
- Restoring the preinstalled Software from the Recovery HDD
- Restoring the Preinstalled Software from Recovery Media



*All users should be sure to read the section Windows® Vista setup.*

## Installing the battery pack

To install a battery, follow the steps below.



- *The battery pack is a lithium ion battery, which can explode if not properly replaced, used, handled or disposed of. Dispose of the battery as required by local ordinances or regulations. Use only batteries recommended by TOSHIBA as replacements.*
- *Do not touch the latch while holding the computer. Or you may get injured by the dropped battery by unintentional release of the latch.*
- *Please do not push the power button before installing the battery pack.*

1. Turn the computer's power off.
2. Disconnect all cables connected to the computer.
3. Insert the battery pack. The Battery Release Latch clicks into place.
4. Secure the Battery Pack Lock to ensure the battery is locked into place. Later, when you want to remove the battery you must disengage this lock first.

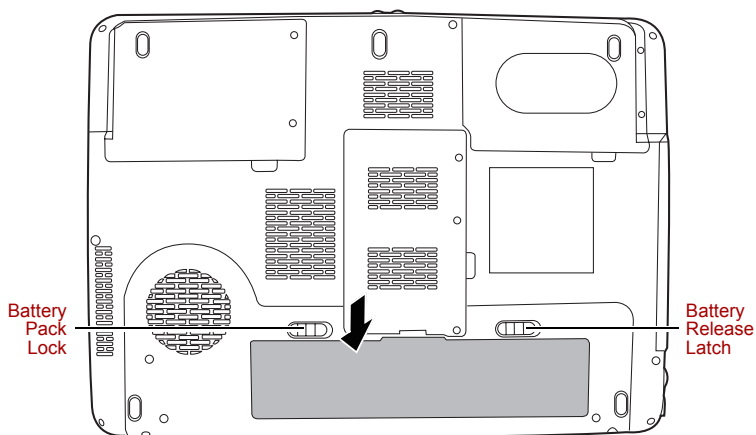

*Securing the battery pack*



Refer to [Removing the battery pack](#) section in Chapter 6, [Power and Power-Up Modes](#), for removing the battery pack.

## Connecting the AC adaptor

Attach the AC adaptor when you need to charge the battery or you want to operate from AC power. It is also the fastest way to get started, because the battery pack will need to be charged before you can operate from battery power.

The AC adaptor can be connected to any power source supplying from 100 to 240 volts and 50 or 60 hertz. For details on using the AC adaptor to charge the battery pack, refer to Chapter 6, [Power and Power-Up Modes](#).



*Use only the AC adaptor supplied as an accessory. Other AC adaptors have different voltage and terminal polarities and use of them may produce heat and smoke or even result in fire or rupture.*



■ *Use only the AC adaptor supplied with your computer or an equivalent adaptor that is compatible. Use of any incompatible adaptor could damage your computer. TOSHIBA assumes no liability for any damage caused by use of an incompatible adaptor.*

■ *When you connect the AC adaptor to the computer, always follow the steps in the exact order as described in the User's Manual. Connecting the power cable to a live electrical outlet should be the last step otherwise the adaptor DC output plug could hold an electrical charge and cause an electrical shock or minor bodily injury when touched. As a general safety precaution, avoid touching any metal parts.*

1. Connect the power cord to the AC adaptor.

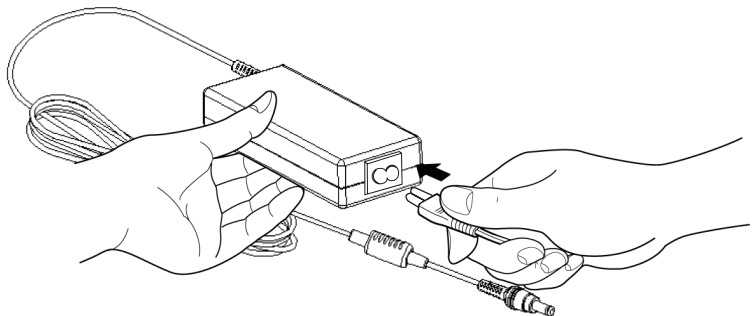

*Connecting the power cord to the AC adaptor*

2. Connect the AC adaptor's DC output plug to the **DC IN 19V** jack on the back of the computer.

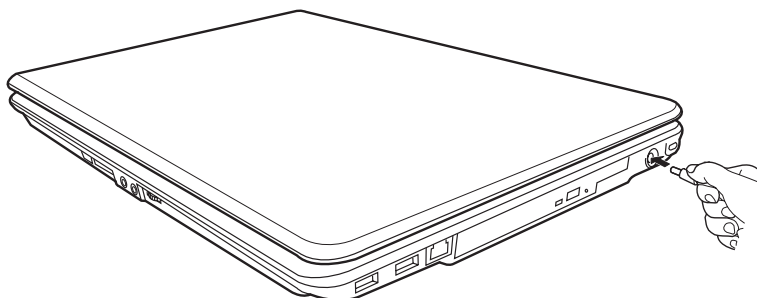

*Connecting the adaptor to the computer*

3. Plug the power cord into a live wall outlet.

## Opening the display

The display panel can be rotated in a wide range of angles for optimal viewing.

1. Lift the panel up and adjust it to the best viewing angle for you.



*Use reasonable care when opening and closing the display panel. Opening it vigorously or slamming it shut could damage the computer.*

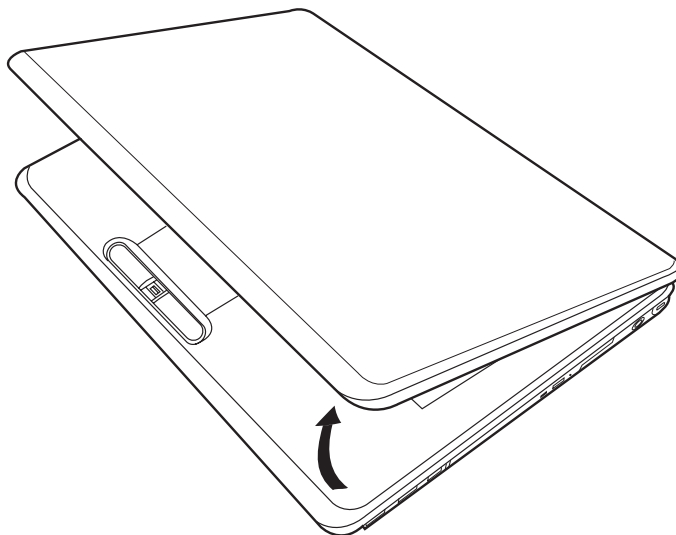

*Opening the display*



## Turning on the power

This section describes how to turn on the power.



*After you turn on the power for the first time, do not turn it off until you have set up the operating system. Refer to the section [Windows Vista™ setup](#).*

Press and hold the computer's power button for two or three seconds.

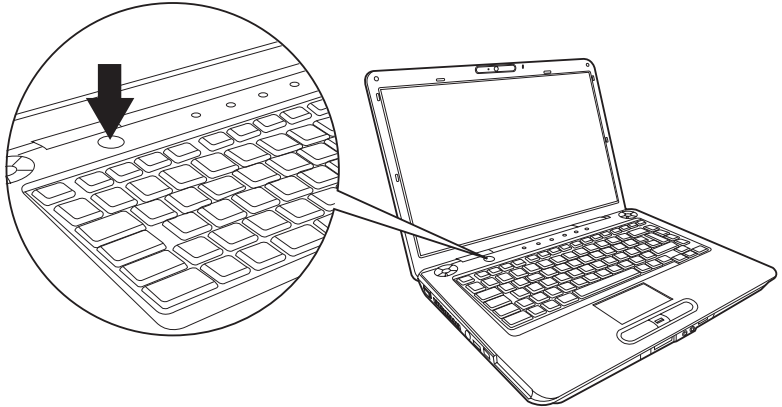

*Turning on the power*

## Windows Vista™ setup

When you first turn on the power, the computer's initial screen is the Microsoft® Windows Vista™ Startup Screen Logo.

Follow the on-screen directions.



*Be sure to read the [Windows End User License Agreement](#) display carefully.*

## Turning off the power

The power can be turned off in one of the following modes: Shut down (Boot), Hibernation or Sleep Mode.



### Shut Down mode (Boot mode)

When you turn off the power in Shut Down mode no data is saved and the computer will boot to the operating system's main screen.

1. If you have entered data, save it to the hard disk.
2. Make sure all disk (disc) activity has stopped, then remove the CD/ DVDs.



*Make sure the **Disk LED and ODD indicator** indicators are off. If you turn off the power while a disk (disc) is being accessed, you can lose data or damage the disk (disc).*

3. Click  then click the arrow icon  located in the power management button . From the pull down menu, choose **Shut Down**.
4. Turn off the power to any peripheral devices.



*Do not turn the computer or devices back on immediately. Wait a moment to let all capacitors fully discharge.*

### Sleep Mode

If you have to interrupt your work, you can turn off the power without exiting from your software. Data is maintained in the computer's main memory. When you turn on the power again, you can continue working right where you left off.



- *When the AC adaptor is connected, the computer will go into Sleep Mode according to the settings in the Power Options.*
- *To restore operation from Sleep Mode, press the power button or press any key. The latter action works only if Wake-up on Keyboard is enabled in HW Setup.*
- *If the computer automatically enters Sleep Mode while a network application is active, the application might not be restored when the computer wakes up from Sleep Mode.*
- *To prevent the computer from automatically entering Sleep Mode, disable Sleep Mode in the Power Options. That action, however, will nullify the computer's Energy Star compliance.*



- *Before entering Sleep Mode, be sure to save your data.*
- *Do not install or remove a memory module while the computer is in Sleep Mode. The computer or the module could be damaged.*
- *Do not remove the battery pack while the computer is in Sleep Mode (unless the computer is connected to an AC power source). Data in memory will be lost.*









### **Benefits of Sleep Mode**

The Sleep Mode feature provides the following benefits:

- Restores the previous working environment more rapidly than does Hibernation Mode.
- Saves power by shutting down the system when the computer receives no input or hardware access for the duration set by the System Sleep Mode feature.
- You can use the panel power off feature.

### **Entering Sleep Mode**

You can enter Sleep Mode in one of three ways:

- Click Start then click the power button () located in the power management buttons ().  
Please note that this feature must be enabled within the Power Options (to access it, click  → **Control Panel** → **System and Maintenance** → **Power Options**).
- Click , click power button  located in the power management buttons , or click arrow button  and select **Sleep** from the menu.
- Close the display panel. This feature must be enabled. Please refer to the Power Options (to access it, click  → **Control Panel** → **System and Maintenance** → **Power Options**).

When you turn the power back on, you can continue where you left when you shut down the computer.



*You can also enable Sleep Mode by pressing **Fn + F3**. Refer to Chapter 5, [The Keyboard](#), for details.*



- *When the computer is shut down in Sleep Mode, the power indicator flashes orange.*
- *If you are operating the computer on battery power, you can lengthen the operating time by turning it off into Hibernation Mode, as Sleep Mode consumes more power.*

## Sleep Mode limitations

Sleep Mode will not function under the following conditions:

- Power is turned back on immediately after shutting down.
- Memory circuits are exposed to static electricity or electrical noise.

## Hibernation Mode

The hibernation feature saves the contents of memory to the hard disk when the computer is turned off. The next time the computer is turned on, the previous state is restored. The hibernation feature does not save the status of peripheral devices.



- *Save your data. While entering Hibernation Mode, the computer saves the contents of memory to the HDD. However, for safety sake, it is best to save your data manually.*
- *Data will be lost if you remove the battery or disconnect the AC adaptor before the save is completed. Wait for the disk indicator to go out.*
- *Do not install or remove a memory module while the computer is in Hibernation Mode. Data will be lost.*

## Benefits of Hibernation Mode

The Hibernation Mode feature provides the following benefits:



- Saves data to the hard disk when the computer automatically shuts down because of a low battery.
- You can return to your previous working environment immediately when you turn on the computer.
- Saves power by shutting down the system when the computer receives no input or hardware access for the duration set by the System hibernate feature.
- You can use the panel power off feature.

## Starting Hibernation Mode



*You can also enable Hibernation Mode by pressing **Fn + F4**. Refer to Chapter 5, [The Keyboard](#), for details.*

To enter Hibernation Mode, follow the steps below.

1. Click .
2. Click the arrow icon  located in the power management button .
3. From the pull down menu, select **Hibernate**.

## Automatic Hibernation Mode

The computer will enter Hibernation mode automatically when you press the power button or close the Display Screen. First, however, make the appropriate settings according to the steps below.

1. Open the **Control Panel**.
2. Open **System and Maintenance** and open **Power Options**.
3. Select the **Choose what the power button does**.
4. Enable the desired Hibernation settings for **When I press the power button** and **When I close the lid**.
5. Click the **Save changes** button.

## Data saving in Hibernation Mode

When you turn off the power in Hibernation Mode, the computer takes a moment to save current memory data to the hard disk. During this time, the **disk** indicator will light.

After you turn off the computer and memory is saved to the hard disk, turn off the power to any peripheral devices.





*Do not turn the computer or devices back on immediately. Wait a moment to let all capacitors fully discharge.*

## Restarting the computer

Certain conditions require that you reset the system. For example, if:

- You change certain computer settings.
- An error occurs and the computer does not respond to your keyboard commands.
- There are three ways to reset the computer system:

1. Click  then click the arrow icon  located in the power management button , and select **Restart** from pull down menu.
2. Press **Ctrl + Alt + Del** to display the menu window, then select **Restart** from the **Shut down** options.
3. Press the power button and hold it down for five seconds. Once the computer has turned itself off, wait between ten and fifteen seconds before turning it on again with the power button.

## System Recovery Options

About 1.5GB hidden partition is allocated on the hard drive for the System Recovery Options.



*The System Recovery Options feature will be unusable if this partition is deleted.*

## System Recovery Options

The System Recovery Options feature is installed on the hard disk when shipped from the factory. The System Recovery Options menu includes some tools to repair startup problems, run diagnostics or restore the system.

You can see the more information about “Startup Repair” in “Windows Help and Support” content.

The System Recovery Options can also be run manually to repair problems.

The procedure is as follows. Follow the instructions shown on the onscreen menu.

1. Turn off the computer.
2. While holding the **F8** key, turn the computer on.
3. The **Advanced Boot Options** menu will be displayed.  
Use the arrow keys to select **Repair Your Computer** and press **Enter**.
4. Follow the on-screen instructions.



*The Windows Vista CompletePC Backup feature can be used on Windows Vista™ Business Edition and Ultimate Edition.*

## Restoring the preinstalled software from the Recovery HDD

Part of the space on the hard disk drive is reserved as recovery partition for restoring the pre-installed software from the hard disk drive.

When re-setting up your hard disk, do not change, delete or add partitions in a manner other than specified in the manual. Otherwise, space for software may be destroyed.

In addition, if you use a third-party partitioning program to reconfigure partitions on your hard disk, it may become impossible to re-setup your computer.

1. Turn off your computer.
2. Hold down the 0 (zero) key on the keyboard and turn on your computer.  
When “TOSHIBA Leading Innovation >>>” appears, release the 0 (zero) key on the keyboard.
3. A menu appears. Follow the on-screen instructions.



*You can not use System Recovery Options if restoring the pre-installed software without System Recovery Options.*



*When you reinstall the Windows operating system, the hard disk will be reformatted and all data will be lost.*

## Restoring the preinstalled software from Recovery Media

If the preinstalled files are damaged, use the Recovery Media you created, or HDD recovery to restore them. To restore the operating system and all preinstalled software, follow the steps below.



*When you reinstall the Windows operating system, the hard disk will be reformatted and all data will be lost.*

1. Load the Recovery Media in the optional optical media drive and turn off the computer's power.
2. Hold down the **F12** key and turn on the power. When **TOSHIBA Leading Innovation >>>** appears, release the **F12** key.
3. Use the upper or lower cursor key to select the CD/DVD in the display menu. For details, refer to the [Boot Priority](#) section in Chapter 7, [HW Setup](#).
4. A menu appears. Follow the on-screen instructions.



*When you removed pre-installed drivers/ utilities or when installing, you can setup the respective drivers/ utilities from the following folder.  
C:\TOSAPINS\\*\*\**





## Chapter 4

### Operating Basics

This chapter gives information on basic operations including using the TouchPad, optical media drives, sound system, modem, the wireless LAN and LAN. It also provides tips on caring for your computer.

#### Using the TouchPad

To use the TouchPad, simply touch and move your finger tip across it in the direction you want the on-screen pointer to go.

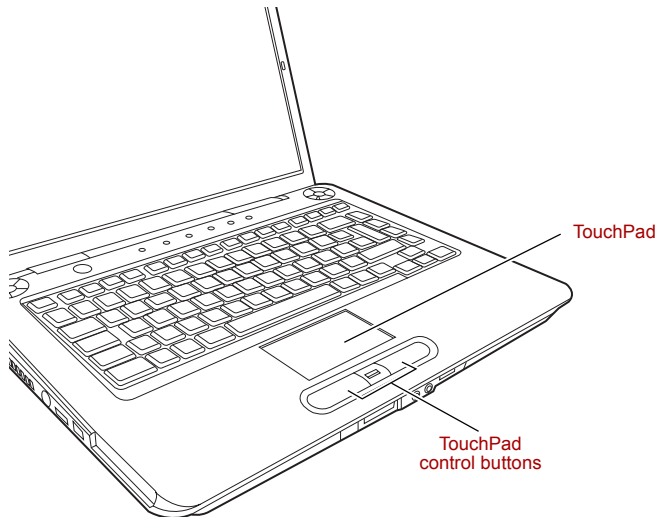

*TouchPad and TouchPad control buttons*

Two buttons below the keyboard are used like the buttons on a mouse pointer. Press the left button to select a menu item or to manipulate text or graphics designated by the pointer. Press the right button to display a menu or other function depending on the software you are using.



*Do not press on the TouchPad too hard or press a sharp object such as a ball point pen against the TouchPad. The TouchPad could be damaged.*

For some functions, you can tap the TouchPad instead of pressing a control button.



**Click:** Tap the TouchPad once

**Double-click:** Tap the TouchPad twice

**Drag and drop:**

1. Hold down the left control button and move the cursor to drag the item you want to move.
2. Lift your finger to drop the item where you want it.

**Scroll:**

*Vertical:* Move your finger up or down the right edge of the TouchPad.

*Horizontal:* Move your finger left or right along the bottom edge of the TouchPad.

## Using the fingerprint sensor

This product has a fingerprint utility installed for the purpose of enrolling and recognizing fingerprints. By enrolling the ID and password to the fingerprint authentication device, it is no longer necessary to input the password from the keyboard. Just by swiping the finger against the fingerprint sensor, the following functions will be enabled:

- Logon to Windows and access a security-enabled homepage through IE (Internet Explorer).
- Files and folders can be encrypted/decrypted and third party access to them prevented.
- Disable the password-protected screen-saver when returning from power-saving (Sleep) mode.
- Pre-OS feature and Single Sign-On feature.
- Authentication of the User Password and Hard Disk Password when booting up the computer.



*To “swipe” refers to the action of reading a fingerprint using the fingerprint sensor.*

## How to swipe the finger

Using the following steps when swiping fingers for fingerprint registration or authentication will help to minimize authentication failures:

1. Align the first joint of the finger to the center of the sensor. Lightly touch the sensor and swipe finger levelly towards you.
2. While lightly touching the sensor, swipe the finger towards you until the sensor surface becomes visible.
3. Ensure the center of the fingerprint is on the sensor when swiping the finger.

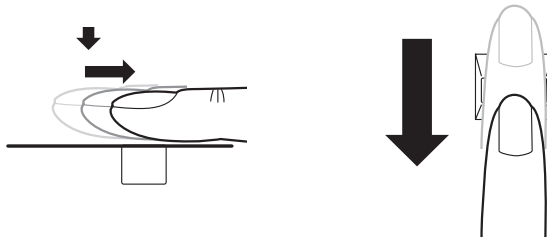

*Slide the finger over the recognition sensor*



- **Avoid swiping with the finger stiff or pressed-on too hard:**  
*Fingerprint reading may fail if the center of the fingerprint is not touching on the sensor, or when finger is swiped while pressing hard. Make sure that the center of the fingerprint is touching the sensor before swiping.*
- **Confirm the center of the fingerprint whirl before swiping:**  
*The thumb's fingerprint has a bigger whirl, which is prone to misalignment and distortions. This will cause difficulty in registration and a drop in the authentication success rate. Always confirm the center of the fingerprint whirl so that it is swiped along the centerline of the sensor.*
- **When fingerprint reading is not successful:**  
*There is a possibility of authentication failures if the finger is swiped too quickly or too slowly. Follow the onscreen instructions to adjust the speed of the swipe.*

## Points to note about the fingerprint sensor

Failure to follow these guidelines might result in (1) damage to the sensor or cause sensor failure, (2) finger recognition problems, or lower finger recognition success rate.

- Do not scratch or poke the sensor with your nails or any hard or sharp objects.
- Do not press the sensor strongly.
- Do not touch the sensor with a wet finger or any wet objects. Keep sensor surface dry and free of water vapor.
- Do not touch the sensor with a soiled finger. Minute foreign particles on a soiled or dirty finger may scratch the sensor.
- Do not paste stickers or write on the sensor.
- Do not touch the sensor with a finger or any object with built-up static electricity.

Observe the following before you place your finger on the sensor whether for fingerprint enrollment/registration or recognition.

- Wash and dry your hands thoroughly.
- Remove static electricity from your fingers by touching any metal surface. Static electricity is a common cause of sensor failures, especially when the weather is dry.
- Clean the sensor with a lint-free cloth. Do not use detergent to clean the sensor.
- Avoid the following finger conditions for enrollment or recognition as they may result in fingerprint enrollment errors or a drop in the fingerprint recognition success rate.
  - Soaked or swollen finger (e.g. after taking bath)
  - Injured finger
  - Wet finger
  - Soiled or oily finger
  - Extremely dry skin condition on finger

Observe the following to improve the fingerprint recognition success rate.

- Enroll two or more fingers.
- Enroll additional fingers if recognition failure occurs often using enrolled fingers.
- Check your finger condition. Changed conditions, such as injured, rough, extremely dry, wet, soiled, dirty, oily, soaked, swollen fingers, may lower the recognition success rate. Also if the fingerprint is worn down or the finger becomes thinner or fatter, the recognition success rate may be lowered.

- The fingerprint for each finger is different and unique. Please ensure that only the registered or enrolled fingerprint or fingerprints are used for identification.
- Check sliding position and speed.
- Fingerprint data is enrolled up to 30~34.
- Fingerprint data is stored into the nonvolatile memory in the fingerprint sensor. Deleting fingerprint data with Delete menu on Fingerprint Software Management before you dispose the computer is recommended.

## How to delete the fingerprint data

Saved fingerprint data is stored in the Non-volatile memory inside the fingerprint sensor. If you hand over the PC to others, or dispose of it, to do the following operations is recommended.

1. Click **Start**, point to **All Programs**, point to **TrueSuite Access Maganer** and click it.
2. The **TrueSuite Access Maganer** Fingerprint Software screen is displayed.
3. Enter your Windows Password and click **Next** to enter the Control Center. Or swipe your enrolled finger to enter the Control Center.
4. Click **Delete All Fingerprints**.

## Fingerprint sensor limitations

- The fingerprint sensor compares and analyzes the unique characteristics in a fingerprint.
- A warning message will be displayed when recognition is abnormal or recognition is not successful within a fixed duration.
- The recognition success rate may differ from user to user.
- Toshiba does not guarantee that this fingerprint recognition technology will be error-free.
- Toshiba does not guarantee that the fingerprint sensor will recognize the enrolled user or accurately screen out unauthorized users at all times. Toshiba is not liable for any failure or damage that might arise out of the use of this fingerprint recognition software or utility.

## Points to note about the fingerprint utility

- If Windows Vista™'s file encryption function EFS (Encryption File System) is used to encrypt a file, the file cannot be further encrypted using the encryption function of this software.
- You can back up the fingerprint data or the information registered to Password Bank.
- Please use Import/Export menu on Fingerprint Software Management.
- Please also refer to the fingerprint utility **Help** file for more information. You can start it using the following method:
  - Click **Start**, point to **All Programs**, point to **TrueSuite Access Maganer** and click **Document**.
  - Click **Start**, point to **All Programs**, point to **TrueSuite Access Maganer** and click it. The main screen is displayed. Click **Help** in the upper right corner of the screen.

## Set up procedure

Please use the following procedure when first using fingerprint authentication.

### *Fingerprint registration*

Enroll the required authentication data using the Fingerprints Enrollment Wizard.



- *The fingerprint authentication uses the same Windows logon ID and password. If the Windows logon password has not been setup, please do so before registration.*
- *Up to 30~34 fingerprint patterns can be registered.*

1. Click **Start**, point to **All Programs**, point to **TrueSuite Access Maganer** and click it. Or double click the icon in the Task Bar.
2. The Enter Windows Password screen is displayed. Enter a password into the **Enter Windows Password** field. Click **Next**.
3. The Control Center screen is displayed. Click the non-enrolled finger icon above the finger.
4. The Fingerprint Enrollment screen is displayed. Confirm the message and click **Next**.
5. The Scanning Practice screen is displayed. You can practice swiping your finger. When you have finished practicing swiping your finger, click **Next**.
6. The Fingerprint Image Capture screen is displayed. Follow the onscreen instructions and use the same finger you have selected under the Control Center to swipe your finger with good images three times for the fingerprint template to be created.

7. In case of finger injury or authentication failure, it is recommended that another fingerprint also be enrolled. The following message will be displayed: [We recommended enrolling at least two fingerprint images.] Click **OK** and repeat steps 3, 4, 5 and 6 with another finger.

## Windows logon via fingerprint authentication

In place of the usual Windows logon by ID and password, fingerprint authentication also allows logon to Windows.

This is useful especially when many users are using the PCs, as user selection can be skipped.

### *Fingerprint authentication procedure*

1. Start up the computer.
2. The **Logon Authorization** screen is displayed. Choose any of the enrolled fingers and swipe the fingerprint on the sensor. If authentication is successful, the user will be logged on to Windows.



- *If the fingerprint authentication fails, please logon using the Windows logon password.*
- *Please logon using the Windows logon password if the fingerprint authentication failed for five times. To logon using the Windows logon password, enter the Windows logon password at the [Welcome] screen as normal.*
- *A warning message will be displayed when authentication is abnormal or authentication is not successful within a fixed duration.*

## Fingerprint system boot authentication

### *General*

The fingerprint authentication system can be used to replace the keyboard-based User Password authentication system when booting up.

If you do not want to use the fingerprint authentication system for password authentication when booting up, but prefer to use the keyboard-based system instead, press the **BACK SPACE** key when the Fingerprint System Bootjuhu Authentication screen is displayed. This will switch the password input screen to the keyboard-based one.



- *It is necessary to register the User Password before using the fingerprint Pre-OS feature and its extended function, the fingerprint Single Sign-On feature. Please use TOSHIBA HW Setup to register the User Password.*
- *If you fail fingerprint authentication more than five times, you must enter the User Password or Supervisor Password manually to start the computer.*
- *When swiping, please do it slowly and at a constant speed. If this does not improve the authentication rate, please adjust the speed.*
- *If there are any changes in the environment or settings related to authorization, you will be required to provide authorization information such as a User Password and HDD password.*

### **How to enable fingerprint system boot authentication settings**

It is necessary to first enroll your fingerprint with the TrueSuite Access Maganer application prior to enabling and configuring the fingerprint Pre-OS feature.

Check that your fingerprint is enrolled before configuring the settings.

1. Swipe your finger across the fingerprint sensor. Or enter Windows password and click **Next**.
2. Click **settings**.
3. The **Administrator Settings** screen is displayed. Place a checkmark in “Enable Pre-OS Fingerprint Authentication” and click **OK**.

The modified configuration for fingerprint Pre-OS feature becomes effective the next time the system is booted up.

## **Fingerprint Single Sign-On feature**

### **General**

This is a feature that allows the user to complete the authentication for both the User Password (and optionally, the HDD user and Supervisor passwords) and logging on to Windows using only one fingerprint authentication when booting up. It is necessary to register the User Password and Windows Logon password before using the fingerprint Pre-OS feature and this fingerprint Single Sign-On feature. Please use TOSHIBA HW Setup to register your User Password.

Only one fingerprint authentication is required to replace the User Password (and, if selected, the HDD user and Supervisor passwords) and Windows Logon password.



## ***How to enable fingerprint Single Sign-On feature***

It is necessary to first enroll your fingerprint with the TrueSuite Access Maganer application prior to enabling and configuring the fingerprint Single Sign-On feature. Check that the fingerprint is enrolled before configuring the settings.

1. Swipe your finger across the fingerprint sensor. Or enter Windows password and click **Next**.
2. Click **settings**.
3. The **Administrator Settings** screen is displayed. Place a checkmark in "Enable Pre-OS Fingerprint Authentication".
4. Then, place a checkmark in "Enable Single Sign-On Fingerprint Authentication" and click **OK**.

The modified configuration for the fingerprint Single Sign-On feature becomes effective the next time the system is booted up.

## ***Fingerprint utility limitations***

TOSHIBA does not guarantee that the fingerprint utility technology will be completely secure or error-free. TOSHIBA does not guarantee that the fingerprint utility will accurately screen out unauthorized users at all times. TOSHIBA is not liable for any failure or damage that might arise out of the use of the fingerprint software or utility.

## **USB Sleep and Charge function**

Your computer can supply USB bus power (DCSV) to the USB port even when the power of the computer is turned OFF. "Power OFF" includes Sleep Mode, Hibernation Mode or shutdown state.

This function can only be used for ports that support the USB Sleep and Charge function (hereinafter called "compatible ports").

Compatible ports are USB ports that have the (⚡) symbol icon.

You can use the "USB Sleep and Charge function" to charge certain USB-compatible external devices such as mobile phones or portable digital music players.

However, the "USB Sleep and Charge function" may not work with certain external devices even if they are compliant with the USB specification. In those cases, turn the power of the computer ON to charge the device.



- *The "USB Sleep and Charge function" only works for compatible ports. This function is disabled in the default setting. To enable it, you must change [Disabled] to [Enabled] in the HW setup.*
- *When "USB Sleep and Charge function" is set to [Enabled] in HW Setup, USB bus power (DC5V) will be supplied to compatible ports even when the power of the computer is turned "OFF". USB bus power (DC5V) is similarly supplied to the external devices which are connected to the compatible ports. However, some external devices cannot be charged solely by supplying USB bus power (DC5V). As for the specifications of the external devices, please contact the device manufacturer or check the specifications of the external devices thoroughly before use.*
- *Using the USB sleep and charge function to charge external devices will take longer than charging the devices with their own chargers.*
- *If external devices are connected to compatible ports when the AC adaptor is not connected to the computer, the battery of the computer will be depleted even when the power of the computer is turned OFF. As such, we recommend that you connect the AC adaptor to the computer when using the USB sleep and charge function.*
- *External devices connected to the USB bus power (DC5V) function that interfaces with the power ON/OFF of the computer may always be in an operational state.*
- *When there is a current overflow of the external devices connected to the compatible ports, USB bus power (DC5V) supply may be stopped for safety reasons.*



*Metal paper clips or hair pins/clips will generate heat if they come into contact with USB ports. Do not allow USB ports to come into contact with metal products, for example when carrying the computer in your bag.*

## **How to enable/disable USB sleep and charge function**

You can set enable/disable USB sleep and charge function in HW setup. Refer to the [USB Sleep and Charge function](#) in Chapter7, *HW Setup*.

## Using the Web Camera

This section describes the bundled webcam utility, which can capture still and video images. The web camera will auto-run when Windows starts.



*Please unstick the protective plastic-film before using the Web Camera*

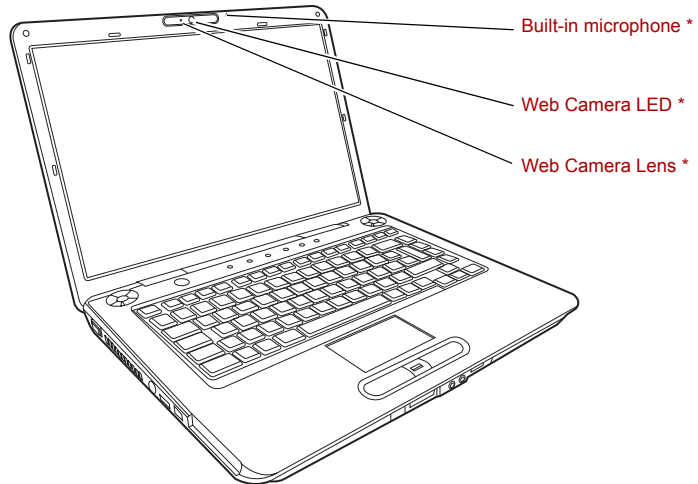

\* Provided with some models

## Using the software

The web camera software is pre-configured to start when you turn on Windows Vista; if you need to restart it go to **Start** → **All Programs** → **Camera Assistant Software** → **Camera Assistant Software**.

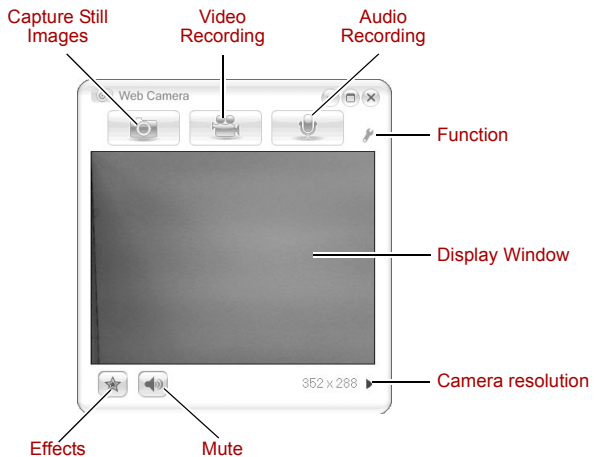

<b>Capture Still Images</b>	Click to see a preview of the captured image; you can also e-mail the image.
<b>Video Recording</b>	Click to prepare for recording. Click again to start recording. One more to stop recording and see preview of the video.
<b>Audio Recording</b>	Click to start recording, click again to stop and listen to a preview of the audio.
<b>Function</b>	Access additional functions: About, Player, Effects, Properties, Settings and Help.
<b>About</b>	Displays software manufacturer details.
<b>Player</b>	Play video files.
<b>Effects</b>	Choose images to be displayed on the capture screen.
<b>Properties</b>	Choose from the <b>Options</b> tab to flip, zoom, flicker rate, night mode and backlight compensation; in the <b>Image</b> tab change the color settings; in the <b>Profiles</b> tab change the lighting conditions.
<b>Settings</b>	Choose from the: <b>Options</b> tab to change the tool bar position; the <b>Picture</b> tab to select picture output options such as size, export file and save path; the <b>Video</b> tab to choose video output settings such as Frame Rate, Size, Compression and the frame rate, size, record compressor, and save path; the <b>Audio</b> tab to change the audio device, audio compressor, audio volume and save path.
<b>Help</b>	Displays the help files for the software.

## Using the microphone

Your computer has a built-in microphone that can be used to record monaural sounds into your applications. It can also be used to issue voice commands to applications that support such functions. (Built-in microphone is provided with some models)

Since your computer has a built-in microphone and speaker, “feedback” may be heard under certain conditions. Feedback occurs when sound from the speaker is picked up in the microphone and amplified back to the speaker, which amplifies it again to the microphone.

This feedback occurs repeatedly and causes a very loud, high-pitched noise. It is a common phenomenon that occurs in any sound system when the microphone input is output to the speaker (throughput) and the speaker volume is too loud or too close to the microphone. You can control throughput by adjusting the volume of your speaker or through the Mute function in the Master Volume panel. Refer to your Windows documentation for details on using the Master Volume panel.

## Using the optical disc drive

The text and illustrations in this section refer primarily to the optical disc drive. However, operation is the same for all other optical media drives. The full-size drive provides high-performance execution of CD/DVD-based programs. You can run either 12 cm (4.72") or 8 cm (3.15") CDs without an adaptor. An ATAPI interface controller is used for CD/DVD operation. When the computer is accessing a CD/DVD, an indicator on the drive glows.

Refer also to the [Writing CD/DVD with the DVD Super Multi drive or HD DVD-ROM drive supporting DVD±R DL](#) section for precautions on writing to CD/DVD.

### Loading discs

To load a disc, follow the steps below and refer to the figures.

1. a. When the power is on, press the eject button to open the drawer slightly.



*Pressing the eject button*

- b. Pressing the eject button will not open the drawer when the disc drive's power is off. If the power is off, you can open the drawer by inserting a slender object (about 15 mm) such as a straightened paper clip into the eject hole just to the right of the eject button.

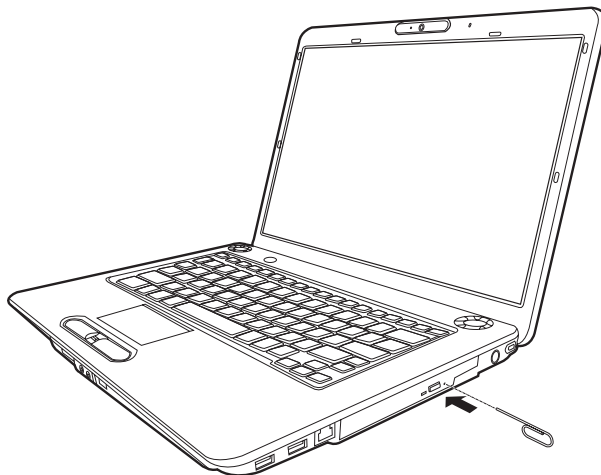

*Manual release with the eject hole*

- 2. Grasp the drawer gently and pull until it is fully opened.

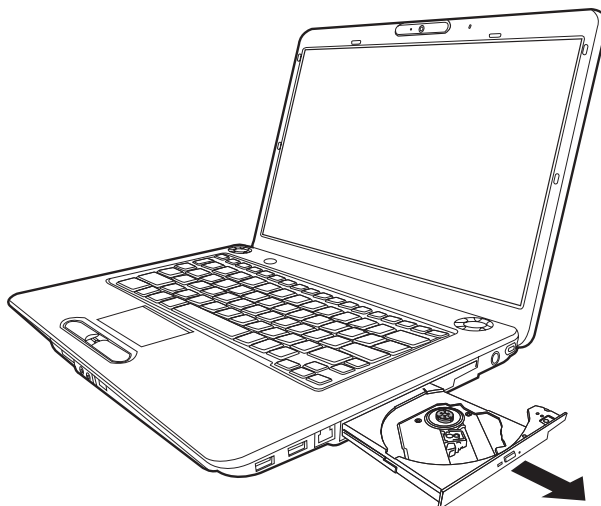

*Pulling the drawer open*

3. Place the disc, label side up, in the drawer.

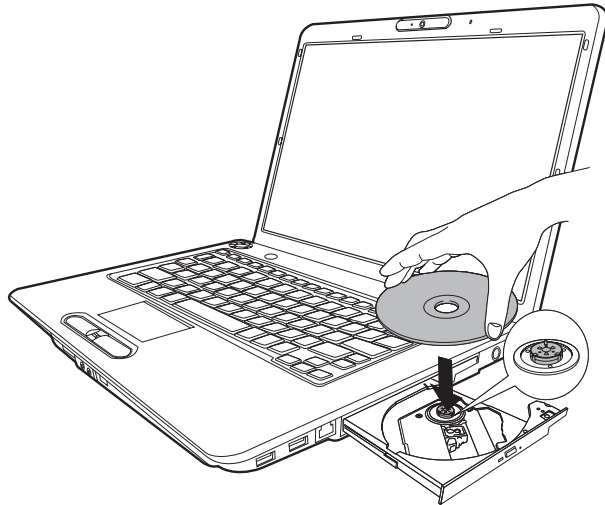

*Inserting a disc*



*When the drawer is fully opened, the edge of the computer will extend slightly over the disc tray. Therefore, you will need to turn the disc at an angle when you place it in the tray. After seating the disc, however, make sure it lies flat, as shown in the figure above.*



- *Do not touch the laser lens. Doing so could cause misalignment.*
- *Keep foreign matter from entering the drive. Check the back edge of the tray to make sure it carries no debris before closing the drive.*

4. Press gently at the centre of the disc until you feel it click into place. The disc should lie below the top of the spindle, flush with the spindle base.
5. Push the center of the drawer to close it. Press gently until it locks into place.



*If the disc is not seated properly when the drawer is closed, the disc might be damaged. Also, the drawer might not open fully when you press the eject button.*

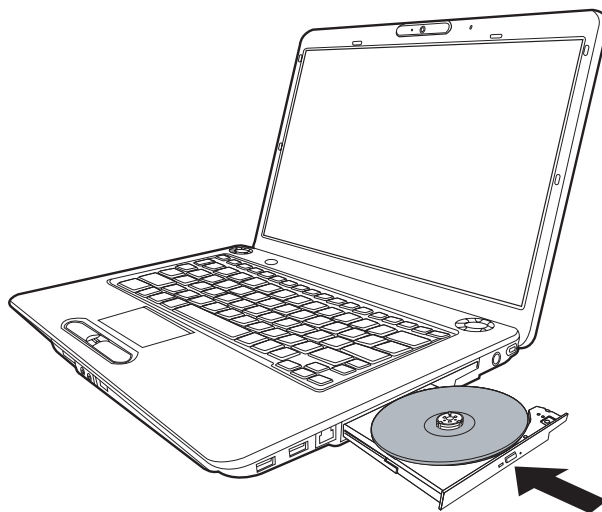

*Closing the disc drawer*

## Removing discs

To remove the disc, follow the steps below and refer to the figure.



*Do not press the eject button while the computer is accessing the disc drive. Wait for the optical media drive indicator to go out before you open the drawer. Also, if the disc is spinning when you open the drawer, wait for it to stop before you remove it.*

1. To pop the drawer partially open, press the eject button. Gently pull the drawer out until it is fully opened.



- *When the drawer pops open slightly, wait a moment to make sure the disc has stopped spinning before pulling the drawer fully open.*
- *Turn off the power before you use the eject hole. If the disc is spinning when you open the drawer, the disc could fly off the spindle and cause injury.*



2. The disc extends slightly over the sides of the drawer so you can hold it. Hold the disc gently by its edges and lift it out.

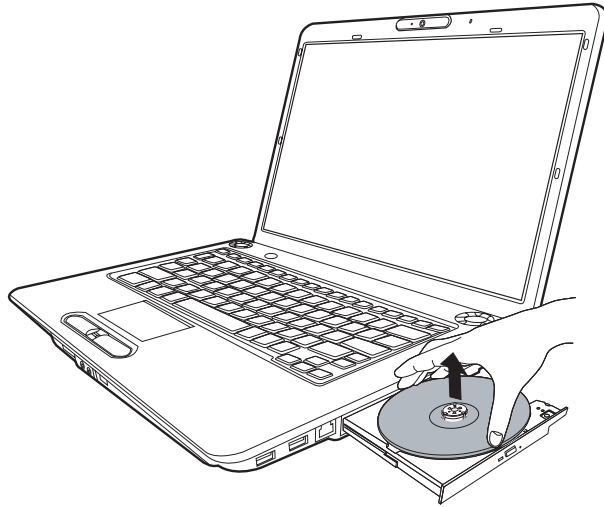

*Removing a disc*

3. Push the centre of the drawer to close it. Press gently until it locks into place.

## Writing CD/DVD with the DVD Super Multi drive or HD DVD-ROM drive supporting DVD±R DL



*Some models in this series are equipped with Writing CD/DVD with the DVD Super Multi drive or HD DVD-ROM drive (Supporting DVD±R DL).*

You can use the DVD Super Multi drive or HD DVD-ROM drive to write data to either CD-R/RW or DVD-R/-RW/+R/+RW/-RAM discs. The following applications for writing are preinstalled: TOSHIBA Disc Creator and TOSHIBA Direct Disc Writer. Ulead Movie factory for TOSHIBA.

### **Important message (DVD Super Multi drive or HD DVD-ROM drive supporting DVD±R DL)**

Before you write or rewrite to CD-R/RW or DVD-R/-RW/+R/+RW/-RAM discs, read and follow all setup and operating instructions in this section. If you fail to do so, the DVD Super Multi drive or HD DVD-ROM drive may not function properly, and you may fail to write or rewrite, lose data or incur other damage.

## Before writing or rewriting

- Based on TOSHIBA's limited compatibility testing, we suggest the following manufacturers of CD-R/RW and DVD-R/+R/-RW/+RW/-RAM discs. However, in no event does TOSHIBA guarantee the operation, quality or performance of any disc. Disc quality can affect write or rewrite success rates.

CD-R: TAIYO YUDEN Co., Ltd.  
 MITSUBISHI KAGAKU MEDIA CO, LTD.  
 Ricoh Co., Ltd.  
 Hitachi Maxell Ltd.

CD-RW: MITSUBISHI KAGAKU MEDIA CO, LTD.  
 Ricoh Co., Ltd.

High Speed CD-RW: MITSUBISHI KAGAKU MEDIA CO, LTD.  
 Ricoh Co., Ltd.

Ultra Speed CD-RW: MITSUBISHI KAGAKU MEDIA CO, LTD.

DVD-R: **DVD Specifications for Recordable disc for General Version2.0**

TAIYO YUDEN Co., Ltd.  
 Matsushita Electric Industrial Co., Ltd.

DVD-R(DL): MITSUBISHI KAGAKU MEDIA CO, LTD.

DVD+R: MITSUBISHI KAGAKU MEDIA CO, LTD.  
 Ricoh Co., Ltd.

DVD+R(DL): MITSUBISHI KAGAKU MEDIA CO, LTD.

DVD-RW: **DVD Specifications for Recordable Disc for Version 1.1 or 1.2**

Victor Company of Japan, Ltd. (JVC)  
 MITSUBISHI KAGAKU MEDIA CO, LTD.

DVD+RW: MITSUBISHI KAGAKU MEDIA CO, LTD.

DVD-RAM: **DVD Specifications for DVD-RAM Disc for Version2.0, 2.1 or 2.2**

Hitachi Maxell Ltd.  
 Matsushita Electric Industrial Co., Ltd.



*This drive cannot use discs that allow writing of 8speeds or more (DVD-R, DVD+R, DVD+RW ), or 6 speeds or more (DVD-RW)*

- If the disc is poor in quality, dirty or damaged, writing or rewriting errors may occur. Be careful to check the disc for dirt or damage before you use it.
- The actual number of rewrites to CD-RW, DVD-RW, DVD+RW or DVD-RAM is affected by the quality of the disc and the way it is used.

- There are two types of DVD-R discs: authoring and general use discs. Do not use authoring discs. Only general use discs can be written to by a computer drive.
- We can support only Format1 of DVD-R DL. Therefore you cannot do the additional writing. If your data is under 4.7GB, we suggest to use DVD-R (SL) media.
- You can use DVD-RAM discs that can be removed from a cartridge and DVD-RAM discs designed without a cartridge. You can not use a disc with a 2.6GB single-sided capacity and 5.2GB double-sided capacity.
- Other DVD-ROM drives for computers or other DVD players may not be able to read DVD-R/-RW or DVD+R/+RW discs.
- Data written to a CD-R/DVD-R/DVD+R disc cannot be deleted either in whole or in part.
- Data deleted (erased) from a CD-RW, DVD-RW, DVD+RW and DVD-RAM disc cannot be recovered. Check the content of the disc carefully before you delete it. If multiple drives that can write data to discs are connected, be careful not to delete data from the wrong drive.
- In writing to a DVD-R/-RW, DVD+R/+RW or DVD-RAM disc, some disc space is required for file management, so you may not be able to write the full capacity of the disc.
- Since the disc is based on the DVD standard, it might be filled with dummy data if the written data is less than about 1 GB. Even if you write only a small amount of data, it might take time to fill in the dummy data.
- DVD-RAM formatted by FAT32 cannot be read in WindowsR 2000 without DVD-RAM Driver Software.
- When multiple drives that can write data to discs are connected, be careful not to write to the wrong drive.
- Be sure to connect the AC adaptor before you write or rewrite.
- Before you enter Sleep Mode/Hibernation Mode, be sure to finish DVD-RAM writing. Writing is finished if you can eject DVD-RAM media.
- Be sure to close all other software programs except the writing software.
- Do not run software such as a screen saver, which can put a heavy load on the CPU.
- Operate the computer under the power scheme **High Performance**. Do not use power-saving features.
- Do not write while virus check software is running. Wait for it to finish and then disable virus detection programs including any software that checks files automatically in the background.
- Do not use hard disc utilities, including those intended to enhance HDD access speed. They may cause unstable operation and data damage.
- Write from the computer's hard disc drive to the CD/DVD. Do not try to write from shared devices such as a LAN server or any other network device.
- Writing with software other than TOSHIBA Disc Creator is not recommended.

## When writing or rewriting

Please observe/consider the following when you write or rewrite to a CD-R/-RW, DVD-R/-RW/-RAM or DVD+R/+RW disc.

- Do not perform any of the following actions when writing or rewriting:
  - Change users in the Windows® Vista operating system.
  - Operate the computer for any other function, including using a mouse or TouchPad or closing/opening the LCD panel.
  - Start a communication application such as a modem.
  - Apply impact or vibration to the computer.
  - Install, remove or connect external devices, including the following: ExpressCard, USB devices, external display, optical digital devices.
  - Use the audio/video control buttons to reproduce music or voice.
  - Open the DVD Super Multi drive or HD DVD-ROM drive.
- Do not use shut down/log off and Sleep Mode/Hibernation Mode while writing or rewriting.
- Make sure writing or rewriting is completed before going into Sleep Mode/Hibernation Mode. Writing is completed if you can open the DVD Super Multi drive tray or HD DVD-ROM drive tray.
- Set the computer on a level surface and avoid places subject to vibration such as airplanes, trains, or cars. Do not use an unstable surface such as a stand.
- Keep mobile phones and other wireless communication devices away from the computer.
- Always copy data from the hard disk drive to the CD-R/-RW,DVD-R/-RW/-RAM or DVD+R/+RW disc. Do not use cut-and-paste. The original data will be lost if there is a write error.

## Disclaimer (DVD Super Multi drive or HD DVD-ROM drive supporting DVD±R DL)

TOSHIBA does not bear responsibility for the following:

- Damage to any CD-R/RW or DVD-R/-RW/+R/+RW/-RAM disc that may be caused by writing or rewriting with this product.
- Any change or loss of the recorded contents of CD-R/RW or DVD-R/-RW/+R/+RW/-RAM disc that may be caused by writing or rewriting with this product, or for any business profit loss or business interruption that may be caused by the change or loss of the recorded contents.
- Damage that may be caused by using third party equipment or software. Given the technological limitations of current optical disc writing drives, you may experience unexpected writing or rewriting errors due to disc quality or problems with hardware devices. Also, it is a good idea to make two or more copies of important data, in case of undesired change or loss of the recorded contents.

## Writing CD/DVD/HD DVDs on HD DVD-RW drives



*The optical drive installed on this computer cannot write multiple sessions on HD DVD-RW disc sessions. Once a disc has been written to once, it will be finalized. Once finalized, no further writing to the disc will be possible regardless of what portion of the total disc capacity was used.*

You can use the HD DVD-RW drive to write data to either CD-R or CD-RW, DVD-R, DVD-R (Dual Layer), DVD-RW, DVD+R, DVD+R (Double Layer), DVD-RAM, HD DVD-R, HD DVD-R(Dual layer) discs. This computer is provided with TOSHIBA Disc Creator and Ulead® DVD MovieFactory® to allow for the writing to CD, DVD and HD DVD media.

For further information on TOSHIBA Disc Creator and Ulead® DVD MovieFactory®, please refer to each software's online manual or online help. Refer to HD DVD Guide for information on accessing the online manual or online help.



- *Please refer to the Writable discs, Chapter 2 for details about the types of writable CD, DVD and HD DVD discs that can be supported by this computer.*
- *Do not turn off the power to the optical disc drive while the computer is accessing it as this may cause you to lose data.*
- *CD-R/RW media cannot be accessed using the Create CD/DVD option in Media Center.*
- *To write data to CD-R/RW media, use the TOSHIBA Disc Creator feature that is installed on your computer.*



*When writing information to media using an optical drive, you should always ensure that you connect the AC adaptor to a live power socket. It is possible that, if data is written while powered by the battery pack, the write process may sometimes fail due to low battery power - these instances data loss may occur.*

### Important message

Before you write or rewrite to any of the media supported by the HD DVD-RW drive, please read and follow all of the setup and operating instructions in this section. If you fail to do so, you may find that the HD DVD-RW drive may not function properly, and you may fail to write or rewrite information successfully this may cause you to either lose data or incur other damage to the drive or media.

## Legal Footnotes

TOSHIBA does not bear responsibility for the following:

- Damage to any CD-R, CD-RW, DVD-R, DVD-R (Dual Layer), DVD-RW, DVD+R, DVD+R (Double Layer), DVD+RW, DVD-RAM. HD DVD-R. HD DVD-R(Dual Layer) or HD DVD-RW disc that may be caused by writing or rewriting with this product.
- Any change or loss of the recorded contents of CD-R, CD-RW, DVD-R, DVD-R (Dual Layer), DVD-RW, DVD+R, DVD+R (Double Layer), DVD+RW, DVD-RAM. HD DVD-R. HD DVD-R(Dual Layer) or HD DVD-RW media that may be caused by writing or rewriting with this product, or for any business profit loss or business interruption that may be caused by the change or loss of the recorded contents.
- Damage that may be caused by using third party equipment or software.

Given the technological limitations of current optical disc writing drives, you may experience unexpected writing or rewriting errors due to disc quality or problems with hardware devices. In view of this, it is good practice to make two or more copies of important data, in case of any undesired change or loss of the recorded contents.

## Before writing or rewriting

- Based on TOSHIBA's limited compatibility testing, we suggest the following manufacturers of CD-R, CD-RW, DVD-R, DVD-R (Dual Layer), DVD-RW, DVD+R, DVD+R (Double Layer), DVD+RW, DVD-RAM. HD DVD-R. HD DVD-R(Dual Layer) or HD DVD-RW media, however, it must be noted that disc quality can affect write or rewrite success rates. Please also be aware that in no event does TOSHIBA guarantee the operation, quality or performance of any disc.

CD-R: TAIYO YUDEN CO., LTD.

MITSUBISHI KAGAKU MEDIA CO., LTD.

RICOH Co., Ltd.

Hitach Maxell Ltd.

CD-RW: (High-Speed, Multi Speed)

MITSUBISHI KAGAKU MEDIA CO., LTD.

RICOH Co., Ltd.

CD-RW: (Ultra-Speed)

MITSUBISHI KAGAKU MEDIA CO., LTD.

DVD-R: DVD Specifications for Recordable Disc for  
General Version 2.0

TAIYO YUDEN CO., LTD.

Matsushita Electric Industrial Co., Ltd.

DVD+R: MITSUBISHI KAGAKU MEDIA CO., LTD.

RICOH Co., Ltd.

- DVD-RW: DVD Specifications for Recordable Disc for General Version 1.1 or 1.2  
VICTOR COMPANY OF JAPAN.LIMITED  
MITSUBISHI KAGAKU MEDIA CO., LTD.
- DVD+RW: MITSUBISHI KAGAKU MEDIA CO., LTD.  
RICOH Co., Ltd.
- DVD-RAM: DVD Specifications for DVD-RAM Disc for General Version 2.0, 2.1 or 2.2  
Matsushita Electric Industrial Co., Ltd.  
Hitachi Maxell Ltd.
- DVD+R DL: MITSUBISHI KAGAKU MEDIA CO., LTD.
- DVD-R DL: MITSUBISHI KAGAKU MEDIA CO., LTD.
- HD DVD-R: MITSUBISHI KAGAKU MEDIA CO., LTD.  
Hitachi Maxell Ltd.
- HD DVD-R DL: MITSUBISHI KAGAKU MEDIA CO., LTD.
- HD DVD-RW RITEK Co.



- *This drive cannot use discs that allow writing faster than 8x speed (DVD-R, DVD+R and DVD+RW media), 6x speed (DVD-RW media), 5x speed (DVD-RAM media), 4x speed (DVD-R (Dual Layer) media and DVD+R (Double Layer media).*
- *Some types and formats of DVD-R (Dual Layer) and DVD+R (Double Layer) discs may be unreadable.*
- *2.6GB and 5.2GB DVD-RAM media cannot be read from or written to.*
- *DISC created in DVD-R (Dual Layer) format4 (Layer Jump Recording) cannot be read.*
- If the disc is poor in quality, or is dirty or damaged, writing or rewriting errors may be noted - ensure that you check all discs for dirt or damage before you use them.
- The actual number of rewrites to CD-RW, DVD-RW, DVD+RW, DVD-RAM or HD DVD-RW media will be affected by the quality of the disc itself and the way in which it is used.
- There are two types of DVD-R media available, authoring discs and general use discs. Do not attempt to use authoring discs as only general use discs can be written to by a computer drive.
- You can use both DVD-RAM discs that can be removed from a cartridge and DVD-RAM discs designed without a cartridge.

- You may find that other computer DVD-ROM drives or other DVD players may not be able to read DVD-R, DVD-R (Dual Layer), DVD-RW, DVD+R, DVD+R (Double Layer), DVD+RW, HD DVD-R or HD DVD-R(Dual Layer) discs.
- Data written to a CD-R, DVD-R, DVD-R (Dual Layer), DVD+R, DVD+R (Double Layer), HD DVD-R or HD DVD-R(Dual Layer) discs cannot be deleted either in whole or in part.
- Data deleted/erased from a CD-RW, DVD-RW, DVD+RW, DVD-RAM or HD DVD-RW disc cannot be recovered. You must check the content of the disc carefully before you delete it, taking care that, if multiple drives that can write data to discs are connected, you do not delete data from the wrong one.
- In writing to DVD-R, DVD-R (Dual Layer), DVD-RW, DVD+R, DVD+R (Double Layer), DVD+RW, DVD-RAM, HD DVD-R, HD DVD-R(Dual Layer) or HD DVD-RW media, some space is required for file management, so you may not be able to write to the full capacity of the disc.
- Since the disc is based on the DVD standard, it might be filled with dummy data if the written data is less than about 1GB. Therefore, in these circumstance, even if you write only a small amount of data, it might take additional time to fill in the dummy data.
- When multiple drives that can write data to discs are connected, be sure that you do not write to or delete data from the wrong drive.
- Be sure to connect the AC adaptor to the computer before you write or rewrite any information.
- Before you enter either Sleep Mode or Hibernation Mode, take care to ensure that any DVD-RAM writing has been completed. In this instance, writing is finished if you can eject the DVD-RAM media.
- Be sure to close all other software programs except for the writing software itself.
- Do not run software such as a screen saver which can put a heavy load on the processor.
- Operate the computer at its full power settings - do not use any power-saving features.
- Do not write information while virus checking software is running, instead wait for it to finish, then disable the virus protection applications, including any software that checks files automatically in the background.
- Do not use any hard disk utilities, including those that are intended to enhance hard disk drive access speeds, as they may cause unstable operation and damage data.
- CD-RW (Ultra Speed +) media should not be used as data may be lost or damaged.
- You should always write from the computer's hard disk drive onto the CD/DVD/HD DVD - do not try to write from shared devices such as a server or any other network device.



- Writing with software other than TOSHIBA Disc Creator has not been confirmed, therefore operation with other software applications cannot be guaranteed.

## When writing or rewriting

Please observe the following points while you write or rewrite data to CD-R, CD-RW, DVD-R, DVD-R (Dual Layer), DVD-RW, DVD+R, DVD+R (Double Layer), DVD+RW, DVD-RAM, HD DVD-R, HD DVD-R(Dual Layer) or HD DVD-RW media:

- Always copy data from the hard disk drive to the optical disc - do not use the cut-and-paste function as the original data will be lost if there is a write error.
- Do not perform any of the following actions:
  - Change users in the Windows Vista™ operating system.
  - Operate the computer for any other function, including such tasks as using a mouse or Touch Pad, or closing/opening the display panel.
  - Start a communication application such as a modem.
  - Apply impact or vibration to the computer.
  - Install, remove or connect external devices, including such items as a ExpressCard, SD/SDHC memory card, ExpressCard, Memory Stick/Memory Stick Pro, xD picture card, MultiMediaCard, USB device, external monitor, i.LINK device, or an optical digital device.
  - Use the audio/video control button to reproduce music or voice.
  - Open the optical disc drive.
- Do not use shut down, log off, Sleep Mode or Hibernation Mode functions while writing or rewriting.
- Make sure that the write/rewrite operation is completed before going into either Sleep Mode or Hibernation Mode (writing is completed if you can remove an optical disc on the HD DVD-R drive).
- If the media is of poor quality, or is dirty or damaged, writing or rewriting errors may occur.
- Set the computer on a level surface and avoid places subject to vibration such as airplanes, trains or cars. In addition, do not use the computer on an unstable surface such as a stand.
- Keep mobile phones and other wireless communication devices away from the computer.

## TOSHIBA Disc Creator

Note the following limitations when you use TOSHIBA Disc Creator:

- DVD-Video cannot be created using TOSHIBA Disc Creator.
- DVD-Audio cannot be created using TOSHIBA Disc Creator.
- You cannot use TOSHIBA Disc Creator's 'Audio CD for Car or Home CD Player' function to record music to DVD-R, DVD-R (Dual Layer), DVD-RW, DVD+R, DVD+R (Double Layer), DVD+RW, HD DVD-R, HD DVD-R (Dual Layer) or HD DVD-RW media.
- Do not use the 'Disc Backup' function of TOSHIBA Disc Creator in order to copy DVD Video, DVD-ROM, HD DVD Video or HD DVD-ROM material that has copyright protection.
- DVD-RAM discs cannot be backed up using the 'Disc Backup' function of TOSHIBA Disc Creator.
- You cannot back up CD-ROM, CD-R or CD-RW media to DVD-R, DVD-R (Dual Layer), DVD-RW, HD DVD-R, HD DVD-R (Dual Layer) or HD DVD-RW media using the 'Disc Backup' function of TOSHIBA Disc Creator.
- You cannot back up CD-ROM, CD-R or CD-RW media to DVD+R, DVD+R (Double Layer) or DVD+RW media using the 'Disc Backup' function of TOSHIBA Disc Creator.
- You cannot back up DVD-ROM, DVD Video, DVD-R, DVD-R (Dual Layer), DVD-RW, DVD+R, DVD+R (Double Layer), DVD+RW, HD DVD-ROM, HD DVD-R, HD DVD-R (Dual Layer) or HD DVD-RW to CD-R or CD-RW media using the 'Disc Backup' function of TOSHIBA Disc Creator.
- TOSHIBA Disc Creator cannot record in packet format.
- You might not be able to use the 'Disc Backup' function of TOSHIBA Disc Creator to back up a DVD-R, DVD-R (Dual Layer), DVD-RW, DVD+R, DVD+R (Double Layer), DVD+RW, HD DVD-R, HD DVD-R (Dual Layer) or HD DVD-RW disc that was made with other software on a different optical media recorder.
- If you add data to a DVD-R, DVD-R (Dual Layer), DVD+R, DVD+R (Double Layer), HD DVD-R or HD DVD-R (Dual Layer) disc that you have already recorded to, you might not be able to read the added data under some circumstances. For example, it cannot be read under 16-bit operating systems, such as Windows 98SE and Windows Me, while in Windows NT4 you will need Service Pack 6 or later, and in Windows 2000, you will need Service Pack 2. In addition to this, some DVD-ROM and DVD-ROM / CD-R/RW drives cannot read this added data regardless of the operating system.
- TOSHIBA Disc Creator does not support recording to DVD-RAM discs - to achieve this you should use Windows Explorer or another similar utility.

- When you back up a DVD disc, be sure that the source drive supports recording to DVD-R, DVD-R (Dual Layer), DVD-RW, DVD+R, DVD+R (Double Layer) or DVD+RW media - if this is not the case then the source disc might not be backed up correctly.
- When you back up a DVD-R, DVD-R (Dual Layer), DVD-RW, DVD+R, DVD+R (Double Layer), DVD+RW, HD DVD-R, HD DVD-R (Dual Layer) or HD DVD-RW disc, be sure to use the same type of disc.
- You cannot partially delete any data written to a CD-RW, DVD-RW, DVD+RW, HD DVD-RW disc.

## Data Verification

To verify that data has been written or rewritten correctly to a data CD/DVD/HD DVD you should follow the steps below before you begin the write/rewrite process:

1. Display the setting dialog box by one of the following two steps:
  - Click the Recording settings button () for writing on the main toolbar in the Data Disc mode.
  - Select Setting for Each Mode → Data Disc in the Setting menu.
2. Mark the Verify written data check box.
3. Select File Open or Full Compare mode.
4. Click the OK button.

## How to learn more about TOSHIBA Disc Creator

Please refer to the Help files for additional TOSHIBA Disc Creator information.

## Video

You can record video using Ulead DVD MovieFactory® for TOSHIBA.

## When using Ulead DVD MovieFactory® for TOSHIBA:

### How to make a Labelflash DVD

Simplified steps for making a Labelflash DVD:

1. Insert a Labelflash disc in DVD drive.



Set **PRINTING SIDE** for underside.

2. Click **Start** → **All Programs** → **DVD MovieFactory for TOSHIBA** → **Ulead DVD MovieFactory for TOSHIBA Launcher** to launch DVD MovieFactory.
3. Click **Print Disc Label** → **Label Printing**. Ulead Label@Once is started.
4. Click the **General** tab.
5. Choose **DVD Drive** for Printer. e.g. <E:> PIONEER DVD....
6. Add and customize the look of your images and text.
7. Click **Labelflash setting** and choose **Draw Quality**.
8. Click **Print**.

## When Using Ulead MediaFactory for TOSHIBA

### How to make a DVD-Video

Simplified steps for making a DVD-Video from video data captured from a DV-Camcorder:

1. Click  → **All Programs** → **MediaFactory for TOSHIBA** → **Ulead MediaFactory for TOSHIBA Launcher** to launch MediaFactory.
2. Insert a DVD-RW or DVD+RW disc in Burner.
3. Click **Video Disc** → **Burn Video to Disc** to launch **Direct Recording** dialog box, choose **DVD-Video/+VR** to invoke **Straight Capture to Disc** Page.
4. Choose **DVD-Video** format.
5. Confirm the capture source is DV.
6. Press **Capture** button.

Simplified steps for making a DVD-Video from adding video source:

1. Click  → **All Programs** → **MediaFactory for TOSHIBA** → **Ulead MediaFactory for TOSHIBA Launcher** to launch MediaFactory.
2. Click **Video Disc** → **New Project** to invoke 2<sup>nd</sup> Launcher, choose your project type, then invoke MediaFactory.
3. Add source from HD Disk by click **Add video files** button to invoke browser dialog box.
4. Choose the source video then go to Next page to apply Menu.
5. After choose the menu template, press **Next** button to go to **Burning Page**.

6. Choose the output type then press **Burn** button.

## How to learn more about Ulead MediaFactory

Please refer to the Help and Manual files for additional Ulead MediaFactory information.

## Important information for use

Note the following limitations when you write Video DVD:

1. Editing digital video
  - Log in with Administrator rights to use MediaFactory.
  - Make sure that your computer is running on AC power when using MediaFactory.
  - Operate the computer at Full Power. Do not use power-saving features.
  - While you are editing DVD, you can display preview. However, if another application is running the preview might not display properly.
  - MediaFactory cannot edit or play copy protected content.
  - Do not enter sleep or hibernation mode while using MediaFactory.
  - Do not operate MediaFactory immediately after turning on the computer. Please wait until all Disc Drive activity has stopped.
  - When recording to a DV-Camcorder, to ensure you capture all of your data, let the camcorder record for a few seconds before you begin recording your actual data.
  - CD recorder, JPEG functions, DVD-Audio, mini DVD and Video CD functions are not supported in this version.
  - While recording video to DVD, please close all other programs.
  - Do not run software like a screen saver because it can put a heavy load on the CPU.
  - Do not support mp3 decode and encode.
2. Before recording the video to DVD
  - When you record DVD disc, please use only discs recommended by the Drive manufacturer.
  - Do not set the working drive to a slow device like a USB1.1 hard disk drive or it will fail to write DVD.
  - Do not perform any of the following actions:
    - Operate the computer for any other function, including using a mouse to TouchPad or closing/Opening the LCD panel.
    - Bump or cause vibration to the computer.
    - Use the Mode control button and Audio/Video control button to reproduce music or voice.
    - Open the DVD drive.

- Install, remove or connect external devices, including the following: ExpressCard, SD card, USB device, external display, i.LINK. devices, optical digital devices.
  - Please verify your disc after recording important data.
  - DVD-R/+R/+RW disc cannot be written in VR format.
  - Not support to output VCD and SVCD format.
- 3. About Straight to Disc
  - Not support to record on DVD-R/+R disc
  - Not support to record DVD+VR format by HDV
  - HDV support to burn DVD-Video only
  - DVD-VR format not support to add Menu
- 4. About recorded DVDs
  - Some DVD-ROM drives for personal computers or other DVD players may not be able to read DVD-R/+R/-RW/-RAM discs.
  - When playing your recorded disc on your computer, please use WinDVD software application.
  - If you use an over-used rewritable disc, the full formatting might be locked. Please use a brand new disc.

## Media care

This section provides tips on protecting data stored on your CD/DVD/HD DVD.

Handle your media with care. The following simple precautions will increase the lifetime of your media and protect the data stored on them:

### CD/DVD/HD DVD

1. Store your CD/DVD/HD DVD in the container they came in to protect them and keep them clean.
2. Do not bend the CD/DVD/HD DVD.
3. Do not write on, apply a sticker to, or otherwise mar the surface of the CD/DVD/HD DVD that contains data.
4. Hold the CD/DVD/HD DVD by its outside edge or the edge on the centre hole. Fingerprints on the surface can prevent the drive from properly reading data.
5. Do not expose to direct sunlight, extreme heat or cold. Do not place heavy objects on your CD/DVD/HD DVD.
6. If your CD/DVD/HD DVD become dusty or dirty, wipe them with a clean dry cloth. Wipe from the centre out, do not wipe in a circular direction around the CD/DVD/HD DVD. If necessary, use a cloth dampened in water or a neutral cleaner. Do not use benzine, thinner or similar cleaner.

## Modem

Some models has a built in modem.

This section describes how to connect and disconnect the internal modem to and from a telephone jack.



*The internal modem does not support voice functions. All data and fax functions are supported.*



- *In case of a lightning storm, unplug the modem cable from the telephone jack.*
- *Do not connect the modem to a digital telephone line. A digital line will damage the modem.*

## Region selection

Telecommunication regulations vary from one region to another, so you will need to make sure the internal modem's settings are correct for the region in which it will be used.

To select a region, follow the steps below.

1. Click **start**, point to **All Programs, TOSHIBA, Networking**, and click **Modem Region Select**.



*Do not use the Country/Region Select function in the Modem setup utility in the Control Panel if the function is available. If you change the Country/Region in the Control Panel, the change may not take effect.*

2. The Region Selection icon will appear in the Task Bar. Click the icon with the primary mouse button to display a list of regions that the modem supports. A sub menu for telephony location information will also be displayed. A check will appear next to the currently selected region and telephony location.
3. Select a region from the region menu or a telephony location from the sub-menu.
  - When you click a region it becomes the modem's region selection, and the New Location for telephony will be set automatically.
  - When you select a telephony location, the corresponding region is automatically selected and it becomes the modem's current region setting.

## Properties menu

Click the icon with the secondary mouse button to display properties menu on the screen.

## Settings

You can enable or disable the following settings:

### ***AutoRun Mode***

The Region Select utility starts automatically when you start up the operating system.

### ***Open the Dialling Properties dialog box after selecting region.***

The dialing properties dialog box will be displayed automatically after you select the region.

### ***Location list for region selection.***

A submenu appears displaying location information for telephony.

### ***Open dialog box, if the modem and Telephony Current Location region code do not match.***

A warning dialog box is displayed if current settings for region code and telephony location are incorrect.

## Modem Selection

If the computer cannot recognize the internal modem, a dialog box is displayed. Select the COM port for your modem to use.

## Dialing Properties

Select this item to display the dialing properties.



*If you are using the computer in Japan, the Telecommunications Business Law requires that you select Japan region mode. It is illegal to use the modem in Japan with any other selection.*



## Connecting

To connect the modem cable, follow the steps below.



- *The modular cable that comes with the computer must be used to connect a modem. Connect the end of the modular cable with the core to the computer.*
- *In case of a lightning storm, unplug the modem cable from the telephone jack.*
- *Do not connect the modem to a digital telephone line. A digital line will damage the modem.*

1. Plug one end of the modular cable into the modem jack.
2. Plug the other end of the modular cable into a telephone jack.

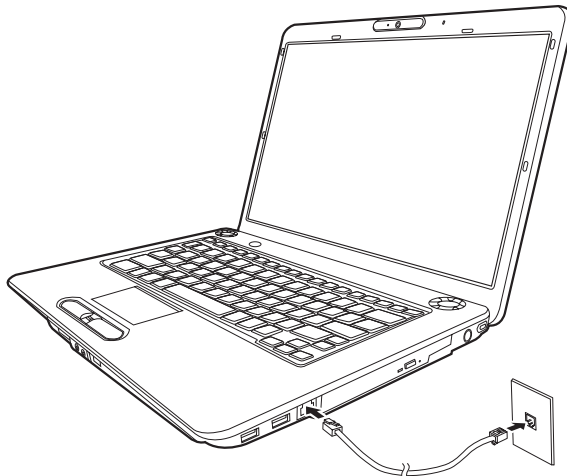

*Connecting the internal modem*



*Do not pull on the cable or move the computer while the cable is connected.*

## Disconnecting

To disconnect the internal modem cable, follow the steps below.

1. Pinch the lever on the connector in the telephone jack and pull out the connector.
2. In the same way, pull the cable's other connector out of the computer.

## Using the FM tuner

The availability of this feature is depending on the model you purchased.

1. Plug the FM tuner antenna into the FM Antenna Jack.

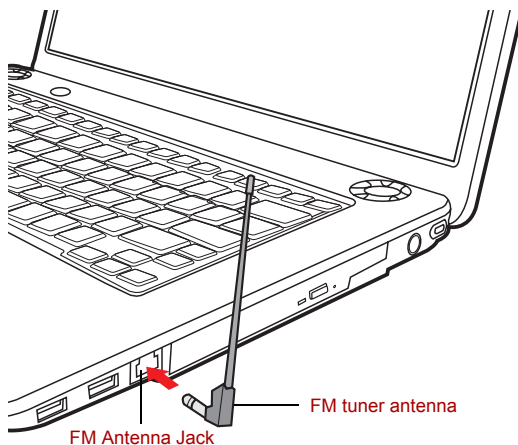

2. Select **Start** → **All Programs** → **FM Tuner Utility** to start FM software.

## Wireless communications

The computer's wireless communication function supports both Wireless LAN and Bluetooth devices.



- *Do not use the Wireless LAN (Wi-Fi) or Bluetooth functionalities near a microwave oven or in areas subject to radio interference or magnetic fields. Interference from a microwave oven or other source can disrupt Wi-Fi or Bluetooth operation.*
- *Turn Wi-Fi and Bluetooth functionalities off when near a person who may have a cardiac pacemaker implant or other medical electric device. Radio waves may affect pacemaker or medical device operation, possibly resulting in serious injury. Follow the instruction of your medical device when using any Wi-Fi or Bluetooth functionality.*
- *Always turn off Wi-Fi or Bluetooth functionality if the computer is near automatic control equipment or appliances such as automatic doors or fire detectors. Radio waves can cause malfunction of such equipment, possibly resulting in serious injury.*
- *It may not be possible to make a network connection to a specified network name using the ad hoc network function. If this occurs, the new network(\*) will have to be configured for all computers connected to the same network in order to re-enable network connections.*  
\* Please be sure to use new network name.

## Wireless LAN

Where present, it supports the A,B, G and draft N standards but it is compatible with other LAN systems based on Direct Sequence Spread Spectrum/Orthogonal Frequency Division Multiplexing radio technology that complies with IEEE802.11 Wireless LAN standard.

- Automatic Transmit Rate Select mechanism in the transmit range of 54, 48, 36, 24, 18, 12, 9 and 6 Mbit/s. (IEEE 802.11a/g)
- Automatic Transmit Rate Select mechanism in the transmit range of 11, 5.5, 2 and 1 Mbit/s. (IEEE 802.11b)
- Roaming over multiple channels
- Card Power Management
- Wired Equivalent Privacy (WEP) data encryption, based on the 128 bit encryption algorithm.
- Advanced Encryption Standard (AES) data encryption, based on 128 bit encryption algorithm.

## Security

- Be sure to enable the encryption function otherwise you may expose your computer to illegal access by an outsider across the Wireless LAN which may cause intrusion, eavesdropping, and the loss or destruction of stored data. TOSHIBA strongly recommend the customer to enable the encryption function.
- TOSHIBA is not liable for the eavesdropping of data due to the use of Wireless LAN and the damage thereof.

## Bluetooth Stack for Windows by TOSHIBA (depends on the model purchased)

Please note that this software is specifically designed for the following operating systems:

- Microsoft® Windows Vista™

Detailed information regarding the use with these operating systems is listed below. Please refer also to the electronic information which is included with each software.



*This Bluetooth Stack is based on Bluetooth Version 1.1/1.2/2.0/2.1+EDR specification. TOSHIBA cannot confirm compatibility between any PC products and/or other electronic devices that use Bluetooth other than TOSHIBA notebook computers.*

## Release Notes related to the Bluetooth Stack for Windows by TOSHIBA

1. Fax application software:  
Regarding FAX application software, there are some software that you cannot use on this Bluetooth Stack.
2. Multi User:  
On Windows Vista™, the use of Bluetooth is not supported in a multi-user environment. This means that, when you use Bluetooth, other users logged onto the same computer will not be able to use its Bluetooth functionality.

### Product Support:

The latest information regarding Operating System support, Language Support or available upgrades can be found on our web site <http://www.toshiba-europe.com/computers/tnt/bluetooth.htm> in Europe or [www.pcsupport.toshiba.com](http://www.pcsupport.toshiba.com) in the United States.

## Wireless communication switch

You can enable or disable the Wireless LAN function, with the on/off switch. No transmissions are sent or received when the switch is off. Slid the Switch to turn it on and turn it off.



*Set the switch to off in airplanes and hospitals. Check the indicator. It will stop glowing when the wireless communication function is off.*

## Wireless activity LED

The wireless activity LED indicates the status of the wireless communication functions.

Indicator status	Indication
LED off	Wireless communication switch is set to off. Automatic power down because of overheating. Power malfunction
LED glows	Wireless communication switch is on. Wireless LAN is turned on by an application.

If you used the Task Bar to disable Wireless LAN, you will need to restart the computer to re-enable it. Alternatively, you can also follow this procedure:

1. In the **Control Panel**, click **System and Maintenance**.
2. Click the **Device Manager**. The Device Manager window opens. Click **Network adapters**.
3. Select your preferred Network adaptor, then click the Enable button in the tool bar.

## LAN

The computer has built-in support for Fast Ethernet LAN or Giga bit Ethernet LAN (depends on the model you purchased).

### LAN cable types



*The computer must be configured properly before connecting to a LAN. Logging onto a LAN using the computer's default settings could cause a malfunction in LAN operation. Check with your LAN administrator regarding set-up procedures.*

If you are using Fast Ethernet LAN (100 megabits per second, 100BASE-TX), be sure to connect with a CAT5 cable or higher. You cannot use a CAT3 cable.

If you are using Giga bit Ethernet LAN, be sure to connect with a CAT5-E cable or higher. You cannot use a CAT5 or a CAT3 cable.

### Connecting LAN cable

To connect the LAN cable, follow the steps below.

1. Turn off the power to the computer and to all external devices connected to the computer.
2. Plug one end of the cable into the LAN jack. Press gently until you hear the latch click into place.

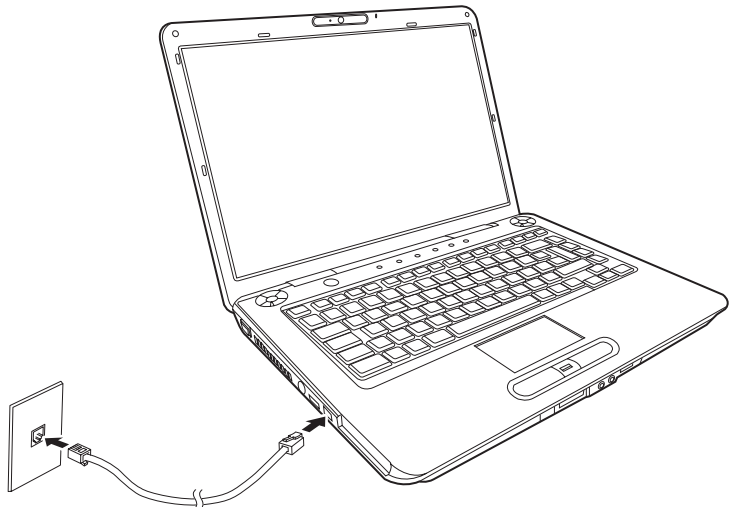

*Connecting the LAN cable*

3. Plug the other end of the cable into a LAN hub connector. Check with your LAN administrator before connecting to a hub.

## Disconnecting LAN cable

To disconnect the LAN cable, follow the steps below.

1. Pinch the lever on the connector in the computer's LAN jack and pull out the connector.
2. Disconnect the cable from the LAN hub in the same manner. Check with your LAN administrator before disconnecting from the hub.

## Cleaning the computer

To help ensure long, trouble-free operation, keep the computer free of dust and use care with liquids around the computer.

- Be careful not to spill liquids into the computer. If the computer does get wet, turn the power off immediately and let the computer dry completely before you turn it on again.
- Clean the computer using a slightly damp (with water) cloth. You can use glass cleaner on the display. Spray a small amount of cleaner on a soft, clean cloth and wipe the screen gently with the cloth.



*Never spray cleaner directly onto the computer or let liquid run into any part of it. Never use harsh or caustic chemical products to clean the computer.*

- Remove the dust from the cooling vents on the Left side of the computer regularly with a vacuum cleaner. Refer to Chapter 2, *The Grand Tour, Left side*.

## Moving the computer

The computer is designed for rugged durability. However, a few simple precautions taken when moving the computer will help ensure trouble-free operation.

- Make sure all disk activity has ended before moving the computer. Check the **HDD** indicator on the computer.
- If a CD/DVD is in the drives, remove it. Also make sure the disc tray is securely closed.
- Turn off (shut down) the computer.
- Disconnect the AC adaptor and all peripherals before moving the computer.
- Close the LCD display panel. Do not pick up the computer by its display panel.
- Before carrying your computer, shut down the computer, disconnect the power cable and wait until the PC cools down. Failure to follow this instruction could result in minor injury.
- Always turn off the power when you move the computer. If the power button has a lock, set it to the lock position. Also be careful not to subject the computer to impact. Failure to follow this instruction could result in damage to computer, computer failure or loss of data.
- Never transport your computer with ExpressCards installed. This could cause damage to your computer and/or ExpressCard, resulting in product failure.
- Use the carrying case when transporting the computer.
- When carrying your computer, be sure to hold it securely so that it does not fall or hit anything.
- Do not carry your computer by holding protruded portions.





# Chapter 5

## The Keyboard

The computer's keyboard layouts are compatible with a 101/102-key enhanced keyboard. By pressing some keys in combination, all the 101/102-key keyboard functions can be executed on the computer.

The number of keys on your keyboard depends on which country/region's keyboard layout your computer is configured with. Keyboards for numerous languages are available.

There are six types of keys: typewriter keys, keypad overlay, function keys, soft keys, Windows® special keys, and cursor control keys.

### Typewriter keys

The typewriter keys produce the upper- and lower-case letters, numbers, punctuation marks, and special symbols that appear on the screen.

There are some differences, however, between using a typewriter and using a computer keyboard:

- Letters and numbers produced in computer text vary in width. Spaces, which are created by a "space character," may also vary depending on line justification and other factors.
- The lowercase l (el) and the number 1 (one) are not interchangeable on computers as they are on a typewriter.
- The uppercase O (oh) and the 0 (zero) are not interchangeable.
- The **Caps Lock** function key locks only the alphabetic characters in uppercase while the shift lock on a typewriter places all keys in the shifted position.
- The **Shift** keys, the **Tab** key, and the **BackSpace** key perform the same function as their typewriter counterparts but also have special computer functions.

## F1 ... F12 function keys

The function keys (not to be confused with **Fn**) are the 12 keys at the top of your keyboard. These keys function differently from other keys.



**F1** through **F12** are called function keys because they execute programmed functions when pressed. Used in combination with the **Fn** key, keys marked with icons execute specific functions on the computer. Refer to the section, *Soft keys: Fn key combinations*, in this chapter. The function executed by individual keys depends on the software you are using.

## Soft keys: Fn key combinations

The **Fn** (function) is used in combination with other keys to form soft keys. Soft keys are key combinations that enable, disable or configure specific features.



*Some software may disable or interfere with soft-key operations. Soft-key settings are not restored by the Sleep Mode feature.*

## Emulating keys on enhanced keyboard

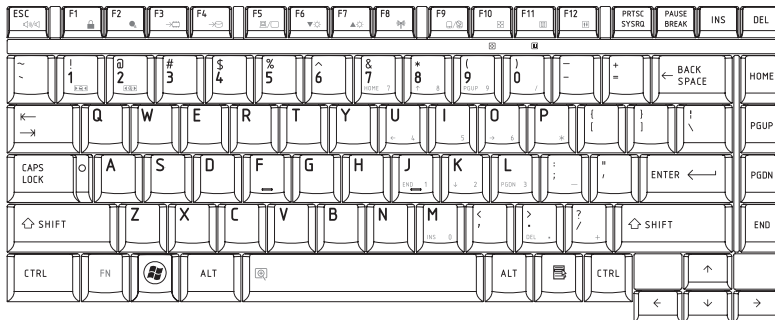

*A 101-key enhanced keyboard layout*

The keyboard is designed to provide all the features of the 101-key enhanced keyboard, shown in figure above. The 101/102-key enhanced keyboard has a numeric keypad and scroll lock key. It also has additional **Enter** and **Ctrl** keys to the right of the main keyboard. Since the keyboard is smaller and has fewer keys, some of the enhanced keyboard functions must be simulated using two keys instead of one on the larger keyboard.

Your software may require you to use keys that the keyboard does not have. Pressing the **Fn** key and one of the following keys simulates the enhanced keyboard's functions.

Press **Fn + F11** to access the integrated keypad. When activated, the keys with gray markings on the bottom edge become numeric keypad keys. Refer to the [Keypad overlay](#) section in this chapter for more information on how to operate these keys. The power on default for both settings is off.

Press **Fn + F12** to lock the cursor on a specific line. The power on default is off.

## Hot keys



**Mute:** Turns the volume on and off.



**Lock:** Enters "Lock computer" mode. To restore your desktop, you need to log on again.



**Power plan:** Displays the power save modes and lets you change the power settings.



**Sleep:** This hot key switches the system to Sleep Mode.



**Hibernate:** This hot key switches the system to Hibernate mode.



**Output:** Changes the active display device.



*Default resolution for simultaneous mode is set to 1024x768. If you connect an RGB (Monitor) that is not 1024x768 resolution, change it in "Display Properties".*



**Brightness (decreases):** Turns the monitor brightness down.



**Brightness (increases):** Turns the monitor brightness up.



**Wireless:** Switches the active wireless devices if the wireless communication switch is switched on.



**TouchPad:** Enables or disables the Touch Pad function.



**Enable Keypad:** Enables or disables the Key Pad function.



**Number Lock:** Enables or disables the Number Lock function.



**Scroll Lock:** Enables or disables the Scroll Lock function.



**Zoom:** Changes the display resolution.



**TOSHIBA Zooming Utility (reduce):** Reduces the icon size on the desktop or the font size within one of the supported application windows.



**TOSHIBA Zooming Utility (enlarge):** Increases the icon size on the desktop or the font size within one of the supported application windows.



*Before using Fn+1 and Fn+2, you must install the TOSHIBA Zooming Utility. The Utility only supports the following application windows: Microsoft Internet Explorer, Microsoft Office, Windows Media Player, Adobe Reader and the icons on the desktop.*

## **Fn Sticky key (Depends on the model you purchased)**

You can use the TOSHIBA Accessibility Utility to make the **Fn** key sticky, that is, you can press it once, release it, and then press an "**F number**" key. To start the TOSHIBA Accessibility Utility, click **start**, point to **All Programs**, point to **TOSHIBA**, point to **Utilities** and click **Accessibility**.

## **Windows<sup>®</sup> special keys**

The keyboard provides two keys that have special functions in Windows<sup>®</sup>: Windows<sup>®</sup> logo key activates the **start** menu and the other, the application key, has the same function as the secondary mouse button.



This key activates the Windows<sup>®</sup> **start** menu.



This key has the same function as the secondary mouse button.

## Keypad overlay

Your computer's keyboard does not have an independent numeric keypad, but its numeric keypad overlay functions like one.

The keys in the centre of the keyboard with gray letters make up the numeric keypad overlay. The overlay provides the same functions as the numeric keypad on the 101/102-key enhanced keyboard described previously.

### Turning on the overlays

The numeric keypad overlay can be used for numeric data input.

#### Numeric mode

To turn on the Numeric mode, press **Fn + F11**. Now try numeric data entry using the keys in the following figure. Press **Fn + F11** again to turn off the overlay.

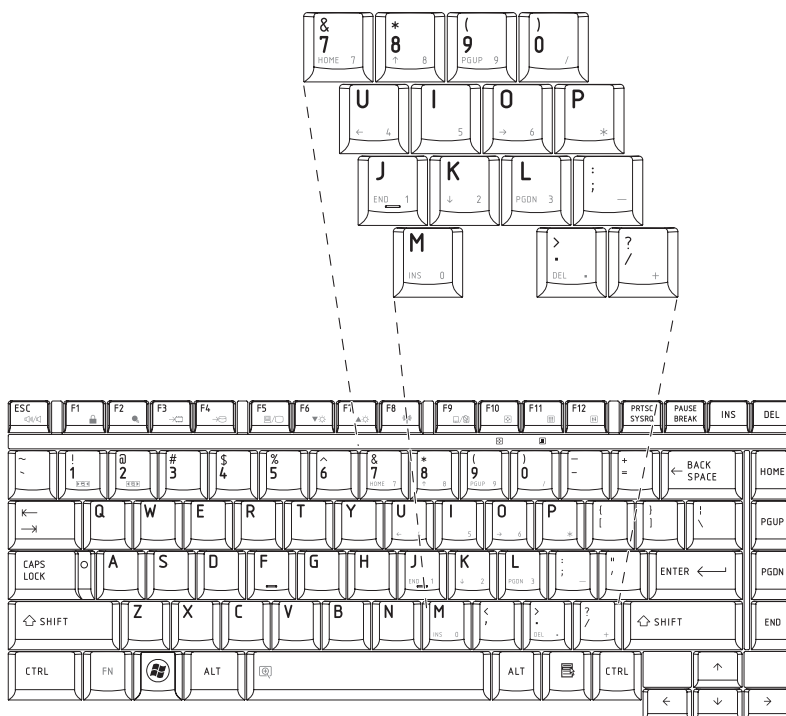

*The numeric keypad overlay*

## Temporarily using normal keyboard (overlay on)

While using the overlay, you can temporarily access the normal keyboard without turning off the overlay:

1. Hold **Fn** and press any other key. All keys will operate as if the overlay were off.
2. Type upper-case characters by holding **Fn + Shift** and pressing a character key.
3. Release **Fn** to continue using the overlay.

## Generating ASCII characters

Not all ASCII characters can be generated using normal keyboard operation. But, you can generate these characters using their ASCII codes.

With the overlay on:

1. Hold down **Alt**.
2. Using the overlay keys, type the ASCII code.
3. Release **Alt**, and the ASCII character appears on the display screen.

With the overlay off:

1. Hold down **Alt + Fn**.
2. Using the overlay keys, type the ASCII code.
3. Release **Alt + Fn**, and the ASCII character appears on the display screen.





## Chapter 6

### Power and Power-Up Modes

The computer's power resources include the AC adaptor and internal batteries. This chapter gives details on making the most effective use of these resources including charging and changing batteries, tips for saving battery power, and power up modes.

#### Power conditions

The computer's operating capability and battery charge status are affected by the power conditions: whether an AC adaptor is connected, whether a battery is installed and what the charge level is for the battery.

**Table Power conditions**

		Power on	Power off (no operation)
<b>Universal AC adaptor connected</b>	Battery fully charged	<ul style="list-style-type: none"> <li>Operates</li> <li>LED: <b>Battery</b> white/green</li> </ul>	<ul style="list-style-type: none"> <li>LED: <b>Battery</b> white/green</li> </ul>
	Battery partially charged or no charge	<ul style="list-style-type: none"> <li>Operates</li> <li>Quick Charge</li> <li>LED: <b>Battery</b> orange</li> </ul>	<ul style="list-style-type: none"> <li>Quick charge</li> <li>LED: <b>Battery</b> orange</li> </ul>
	No battery installed	<ul style="list-style-type: none"> <li>Operates</li> <li>No charge</li> <li>LED: <b>Battery</b> off</li> </ul>	<ul style="list-style-type: none"> <li>No charge</li> <li>LED: <b>Battery</b> off</li> </ul>

**Table Power conditions**

		<b>Power on</b>	<b>Power off (no operation)</b>
<b>Universal AC adaptor not connected</b>	Battery charge is above low battery trigger point	<ul style="list-style-type: none"> <li>Operates</li> <li>LED: <b>Battery</b> off</li> </ul>	
	Battery charge is below low battery trigger point	<ul style="list-style-type: none"> <li>Operates</li> <li>LED: <b>Battery</b> flashes orange</li> </ul>	
	Battery charge is exhausted	Computer shuts down	
	No Battery installed	<ul style="list-style-type: none"> <li>Cannot operates</li> <li>LED: <b>Battery</b> off</li> </ul>	

## Power indicators

As shown in the above table, the **Battery. Power** indicators on the system indicator alert you to the computer’s operating capability and battery charge status.

### Battery indicator

Check the **Battery** indicator to determine the status of the battery pack. The following indicator lights indicate the battery status:

<b>Flashing orange</b>	The battery charge is low. The AC adaptor must be connected to recharge the battery.
<b>Orange</b>	Indicates the AC adaptor is connected and charging the battery.
<b>White/Green</b>	Indicates the AC adaptor is connected and the battery is fully charged.
<b>No light</b>	Under any other conditions, the indicator does not light.



*If the battery becomes too hot while it is being charged, the charge will stop and the battery indicator will go out. When the battery’s temperature falls to a normal range, charge will resume. This occurs whether the computer’s power is on or off.*

### Power indicator

Check the **Power** indicator to determine the power status:

<b>White/Green</b>	Indicates power is being supplied to the computer and the computer is turned on.
<b>Blinking orange</b>	Indicates power is being supplied to the computer while the computer is in Sleep Mode. The indicator turns on for one second and off for two seconds.
<b>No light</b>	Under any other conditions, the indicator does not light.

## Battery types

The computer has the following batteries:

- Battery pack (3cell, 6cell, or 9cell depending on the model.)
- Real Time Clock (RTC) battery



- *The battery pack is a lithium ion battery, which can explode if not properly replaced, used, handled or disposed of. Dispose of the battery as required by local ordinances or regulations. Use only batteries recommended by TOSHIBA as replacements.*
- *Do not remove the battery pack while the computer is in Sleep Mode. Data is stored in RAM, so if the computer loses power it will be lost. When the computer is powered off in Sleep Mode, and the AC adaptor is not connected, the main battery pack supplies power to maintain data and programs in memory. If the battery pack is completely discharged, Sleep Mode does not function and the computer loses all data in memory.*

### Battery pack

When the AC adaptor is not connected, the computer's main power source is a removable lithium ion battery pack, also referred to in this manual as the main battery. You can purchase additional battery packs for extended use of the computer away from an AC power source.

Before you remove the battery pack, set the computer to Hibernation Mode or save your data and shut down the computer. Do not change the battery pack while the AC adaptor is connected.

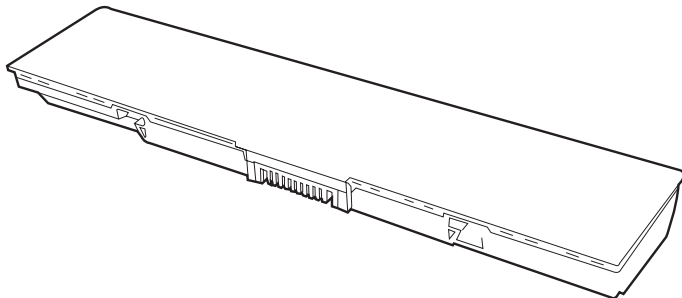

*Battery pack*

To ensure that the battery pack maintains its maximum capacity, operate the computer on battery power at least once a month until the battery pack is fully discharged. Refer to [Extending battery life](#) in this chapter for procedures. If the computer is continuously operated on AC power through an AC adaptor for an extended period, more than a month, the battery may fail to retain a charge. It may not function efficiently over the expected life of the battery and the **Battery** indicator may not indicate a low-battery condition.

## Real Time Clock battery

The Real Time Clock (RTC) battery provides power for the internal real time clock and calendar. It also maintains the system configuration.

If the RTC battery becomes completely discharged, the system loses this data and the real time clock and calendar stop working.



*The computer's RTC battery is a lithium ion battery and should be replaced only by your dealer or by a TOSHIBA service representative. The battery can explode if not properly replaced, used, handled or disposed of. Dispose of the battery as required by local ordinances or regulations.*



- You can change the settings of the Real Time Clock by pressing F2 in POST.
- After configuring the time and date for the Real Time Clock battery, we recommend that you turn the power status of your computer to "ON" so that the Real Time Clock battery is charged. Refer to Chapter 9 [Troubleshooting](#), for details.

If the following message is displayed on the LCD:

**ERROR 0271: Check date and time settings.**

**WARNING 0251: System CMOS checksum bad-Default configuration used.**

**Press [F1] to resume, [F2] to setup.**

The charge in the RTC battery is getting low or has been exhausted. You will need to set the date and time within the BIOS setup using the following steps:

1. Press **F2** key - the BIOS setup screen will be displayed.
2. Set the date in **System Date**.
3. Set the time in **System Time**.
4. Press **F10** key. Confirmation message will appear.

Press **Enter** key. BIOS setup will terminate and the computer will be rebooted.



*After configuring the date and time it is recommended that you switch the computer on and then leave it in this state so that the Real Time Clock battery can be charged.*

## Care and use of the battery pack

The battery pack is a vital component of portable computing. Taking proper care of it will help ensure longer operating time on battery power as well as a longer life for your battery pack. Follow the instructions in this section carefully to ensure safe operation and maximum performance.

### Safety precautions

Mishandling of batteries can cause death, serious injury or property damage. Carefully observe the following advisories:

**Danger:** Indicates an imminently hazardous situation, which could result in death or serious injury, if you do not follow instructions.

**Warning:** Indicates a potentially hazardous situation, which could result in death or serious injury, if you do not follow instructions.

**Caution:** Indicates a potentially hazardous situation, which if not avoided, may result in moderate or minor injury or property damage.

**Note:** Provides important information.

### *Danger*

1. Never try to dispose of the battery pack by burning or expose it to a heating device such as a microwave oven. The battery pack could explode and cause bodily injury.
2. Never try to disassemble, repair or otherwise tamper with a battery pack. The battery pack will overheat and ignite. Leakage of caustic alkaline solution or other electrolytic substances will cause fire or injury, possibly resulting in death or serious injury.
3. Never short-circuit the battery pack by contacting the terminals with a metal object. A short-circuit can cause fire or otherwise damage the battery pack and possibly cause injury. To avoid accidental short-circuit, always wrap the battery pack in plastic and cover the terminals with electrical tape when storing or disposing of the battery pack.
4. Never puncture the battery pack with a nail or other sharp object. Never strike it with a hammer or other object. Never step on it.
5. Never try to charge the battery pack in any manner other than that described in the User's manual. Never connect the battery pack to a plug socket or to an automobile's cigarette lighter socket. It may rupture or ignite.
6. Use only the battery pack supplied with the computer or other device or a battery pack approved by the computer or device's manufacturer. Battery packs have different voltages and terminal polarities. Use of an improper battery could cause smoke, fire or rupture of the battery pack.
7. Never subject a battery pack to heat, such as storage near a heat source. Exposure to heat can cause the battery pack to ignite, explode or leak caustic liquid and cause death or serious injury. It could also fail or malfunction causing data loss.

8. Never expose the battery pack to abnormal shock, vibration or pressure. The battery pack's internal protective device will fail, causing it to overheat, explode, ignite or leak caustic liquids possibly resulting in death or serious injury.
9. Never let a battery pack become wet. A wet battery pack will overheat, ignite or rupture possibly resulting in death or serious injury.

### **Warning**

1. Never allow caustic electrolyte fluid leaked from a battery pack to contact your eyes, skin or clothing. If caustic electrolyte fluid should contact your eyes, immediately wash your eyes with large amounts of running water and seek medical attention, to help prevent eye damage. If electrolyte fluid should contact your skin immediately wash it under running water to prevent rash. If it contacts your clothes, promptly remove them to prevent the fluid from contacting your skin or eyes.
2. Immediately turn off the power, disconnect the AC adaptor and remove the battery if any of the following events are observed in the battery pack: offensive or unusual odor, excessive heat, discoloration or deformation. Never use the computer again until it has been checked by a TOSHIBA service provider. It might generate smoke or fire, or the battery pack might rupture.
3. Make sure the battery is securely installed in the computer before attempting to charge the battery pack. Improper installation could generate smoke or fire, or cause the battery pack to rupture.
4. Keep the battery pack out of reach of infants and children. It can cause injury.

### **Caution**

1. Never continue to use a battery pack after its recharging capacity has become impaired, or after the display of a warning message indicating that the battery pack's power is exhausted. Continued use of an exhausted or impaired battery pack could cause the loss of data.
2. Never dispose of battery packs with normal trash. Bring them to your TOSHIBA dealer or to another recycling centre to save resources and prevent environmental damage. Cover the terminals with electrical tape to prevent short-circuits, which could cause the battery pack to ignite or rupture.
3. Use only battery packs recommended by TOSHIBA as replacements.
4. Always make sure the battery pack is installed correctly and securely. Otherwise, a battery pack could fall out and possibly cause injury.
5. Charge the battery pack only in an ambient temperature between 5 and 35 degrees Celsius. Otherwise, the electrolyte solution might leak, battery pack performance might deteriorate and the battery life might be shortened.

6. Be sure to monitor the remaining battery power. If the battery pack and real time clock battery discharge completely, Sleep Mode will not function and data in memory will be lost. Also, the computer might register an incorrect time and date. In this case, connect the AC adaptor to recharge the batteries.
7. Never install or remove the battery pack without first turning off the power and disconnecting the AC adaptor. Never remove the battery pack while the computer is in Suspend or Sleep Mode. Data will be lost.

### Note

1. Never remove the battery pack while the Wake-up on LAN function is enabled. Data will be lost. Before you remove a battery pack, disable the Wake-up on LAN function.
2. After the battery pack is charged, avoid leaving the AC adaptor connected and the computer turned off for more than a few hours at a time. Continuing to charge a fully-charged battery pack can damage the battery.

## Charging the batteries

When the power in the battery pack becomes low, the **Battery** indicator flashes orange indicating that only a few minutes of battery power remain. If you continue to use the computer while the **Battery** indicator flashes, the computer enables Hibernation Mode (so you don't lose data) and automatically turns off.

You must recharge a battery pack when it becomes discharged.

### Procedures

To recharge a battery pack while it is installed in the computer, connect the AC adaptor to the **DC IN 19V** jack and plug the other end into a working outlet.

The **Battery** indicator glows orange when the battery is being charged.



*Use only the computer connected to an AC power source to charge the battery pack. Never attempt to charge the battery pack with any other charger.*



## Time

The following table shows the approximate time required to fully charge a discharged battery.

### Charging time (hours)

Battery type	Power on	Power off
Battery pack (3cell, 6cell, 9cell)	4-10 hours	4 hours max
RTC battery	About 24 hours	About 24 hours



*The charging time when the computer is on is affected by ambient temperature, the temperature of the computer and how you use the computer. If you make heavy use of external devices, for example, the battery might scarcely charge at all during operation. Refer also to the section [Maximizing battery operating time](#).*

### Battery charging notice

The battery may not charge right away under the following conditions:

- The battery is extremely hot or cold. If the battery is extremely hot, it might not charge at all. To ensure the battery charges to its full capacity, charge the battery at room temperature of 10° to 30°C (50° to 88°F).
- The battery is nearly completely discharged. Leave the AC adaptor connected for a few minutes and the battery should begin charging.

The **Battery** indicator may show a rapid decrease in battery operating time when you try to charge a battery under the following conditions:

- The battery has not been used for a long time.
- The battery has completely discharged and been left in the computer for a long time.
- A cool battery is installed in a warm computer.

In such case, follow the steps below.

1. Fully discharge the battery by leaving it in the computer with the power on until the power automatically shuts off.
2. Plug in the AC adaptor.
3. Charge the battery until the **Battery** indicator glows blue.

Repeat these steps two or three times until the battery recovers normal capacity.



*Leaving the AC adaptor connected will shorten battery life. At least once a month, run the computer on battery power until the battery is fully discharged, then recharge the battery.*

## Monitoring battery capacity

Remaining battery power can be monitored using the following methods.

- Clicking the battery icon on the task bar
- Via the Windows Mobility Center window



- *Wait at least 16 seconds after turning on the computer before trying to monitor the remaining operating time. The computer needs this time to check the battery's remaining capacity and to calculate the remaining operating time, based on the current power consumption rate and remaining battery capacity. The actual remaining operating time may differ slightly from the calculated time.*
- *With repeated discharges and recharges, the battery's capacity will gradually decrease. Therefore, an often used, older battery will not operate for as long as a new battery even when both are fully charged.*

## Maximizing battery operating time

A battery's usefulness depends on how long it can supply power on a single charge.

How long the charge lasts in a battery depends on:

- CPU processing speed (depends on the model you purchased)
- Screen brightness
- Cooling method (depends on the model you purchased)
- System Sleep Mode
- System Hibernation
- Monitor power off
- How often and how long you use the hard disk, optical disc.
- How much charge the battery contained to begin with.
- How you use optional devices, such as an Express Card, to which the battery supplies power.
- Enabling Sleep Mode conserves battery power if you are frequently turning the computer off and on.
- Where you store your programs and data.
- Closing the display when you are not using the keyboard saves power.
- Operating time decreases at low temperatures.
- The condition of the battery terminals. Make sure the battery terminals stay clean by wiping them with a clean dry cloth before installing the battery pack.

## Retaining data with power off

When you turn off your computer with fully charged batteries, the batteries retain data for the following approximate time periods.

<b>Battery pack</b> (3cell, 6cell, 9cell)	Approximately 1.5 days (Sleep mode, 3-cell)
	Approximately 3 days (Sleep mode, 6-cell)
	Approximately 5 days (Sleep mode, 9-cell)
	Approximately 1 month (Shut down mode, all type of battery packs)
<b>RTC battery</b>	Approximately 1 month

## Extending battery life

To maximize the life of your battery pack:

- At least once a month, disconnect the computer from a power source and operate it on battery power until the battery pack fully discharges. Before doing so, follow the steps below.
  1. Turn off the computer's power.
  2. Disconnect the AC adaptor and turn on the computer's power. If it does not turn on go to step 4.
  3. Operate the computer on battery power for five minutes. If the battery pack has at least five minutes of operating time, continue operating until the battery pack is fully discharged. If the **Battery** indicator flashes or there is some other warning to indicate a low battery, go to step 4.
  4. Connect the AC adaptor to the computer and the power cord to a power outlet. The **Battery** indicator should glow orange to indicate that the battery pack is being charged. If the **Battery** indicator does not glow, power is not being supplied. Check the connections for the AC adaptor and power cord.
  5. Charge the battery pack until the Battery indicator glows blue.
- If you have extra battery packs, rotate their use.
- If you will not be using the system for an extended period, more than one month, remove the battery pack.
- Store spare battery packs in a cool dry place out of direct sunlight.

## Replacing the battery pack

When the battery pack reaches the end of its operating life you will need to install a new one. The life of the battery pack is generally about 500 recharges. If the **Battery** indicator flashes orange shortly after fully recharging the battery, the battery pack needs to be replaced.

You might also replace a discharged battery pack with a charged spare when you are operating your computer away from an AC power source. This section explains how to remove and install the battery pack.

### Removing the battery pack

To replace a discharged battery, follow the steps below.



- *When handling battery packs, do not short-circuit the terminals. Also do not drop, hit or otherwise apply impact; do not scratch or break the casing and do not twist or bend the battery pack.*
- *Do not remove the battery pack while the computer is in Sleep Mode. Data is stored in RAM, so if the computer loses power it will be lost.*
- *In Hibernation Mode, data will be lost if you remove the battery or disconnect the AC adaptor before the save is completed. Wait for the **Built-in HDD** indicator to go out.*
- *Do not touch the latch while holding the computer. Or you may get injured by the dropped battery by unintentional release of the latch.*

1. Save your work.
2. Turn the computer's power off. Make sure the **Power** indicator is off.
3. Remove all cables connected to the computer.
4. Turn the computer upside down.
5. Slide and hold the battery release latch to free the battery pack after moving the battery pack lock into its unlock position - then slide the battery pack out of the computer.

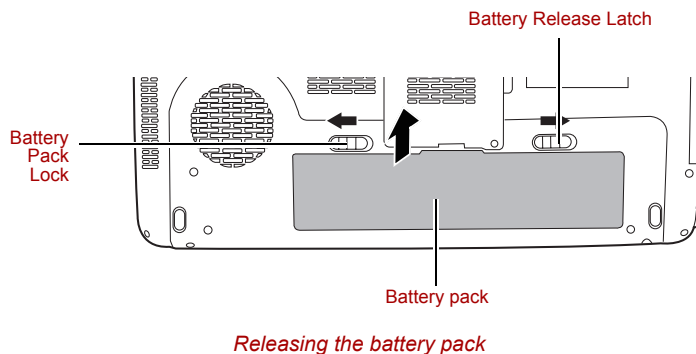

## Installing the battery pack

To install a battery, follow the steps below.



- *The battery pack is a lithium ion battery, which can explode if not properly replaced, used, handled or disposed of. Dispose of the battery as required by local ordinances or regulations. Use only batteries recommended by TOSHIBA as replacements.*
- *Do not touch the latch while holding the computer. Or you may get injured by the dropped battery by unintentional release of the latch.*

1. Turn the computer's power off.
2. Disconnect all cables connected to the computer.
3. Insert the battery pack.
4. Ensure the battery pack lock is moved into its locked position.

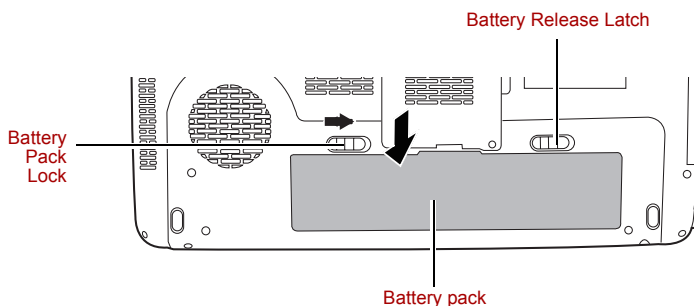

*Securing the battery pack*

## Starting the computer by password

To start up the computer with the user password, follow these steps:

1. Turn on the power as described in Chapter 3, [Getting Started](#). The following message appears:



Password=



*At this point, the hotkeys **Fn + F1** to **F9** do not work. They will function after you enter the password.*

2. Enter the password.
3. Press **Enter**.



*If you enter the password incorrectly three times in a row, the computer shuts off. In this case, you must turn the computer back on to retry password entry.*

or if available

Swipe your fingerprint on the sensor if you have already registered the fingerprint with the Fingerprint utility and enabled **Fingerprint Power on Security**. If you would not like to swipe your finger or cannot authenticate the fingerprint for some reasons, push the **BkSp** key to skip the fingerprint authentication screen. You can try to swipe the fingerprint up to five times. If you failed fingerprint authentication more than five times, you must enter the password manually to start the computer.

## Power-up modes

The computer has the following power-up modes:

- **Boot Mode:** Computer shuts down without saving data. Always save your work before you turn the computer off in boot mode.
- **Hibernation Mode:** Data in memory is saved to the hard disk.
- **Sleep Mode:** Data is maintained in the computer's main memory.



Refer also to the sections [Turning on the power](#) and [Turning off the power](#) in Chapter 3, [Getting Started](#).

## Hot keys

You can use hot keys **Fn + F3** to enter Sleep Mode and **Fn + F4** to enter Hibernation Mode. Refer to Chapter 5, [The Keyboard](#) for details.

## Panel power off/on

You can set up your computer so that power turns off automatically when you close the display panel. When you open the panel, power turns on in Sleep Mode or Hibernation Mode but not in boot mode.



If the panel power off function is enabled and you use Shut down Windows<sup>®</sup>, do not close the display until the shut down function is completed.

## System Auto Off

This feature turns the system off automatically if it is not used for a set duration. The system shuts down in Sleep Mode or Hibernation Mode in Windows<sup>®</sup>.

# Chapter 7

## HW Setup

This chapter explains how to use TOSHIBA HW Setup program to configure your computer. TOSHIBA HW Setup lets you configure settings for General, Password, Display, Boot Priority, Keyboard, LAN, and USB.

### Accessing HW Setup

To run HW Setup, click , **All Programs, TOSHIBA, Utilities, HWSetup.**

### HW Setup Window

The HW Setup window contains the following tabs: General, Password, Display, Boot Priority, Keyboard, USB and LAN .

There are also these three buttons:

<b>OK</b>	Accepts your changes and closes the HW Setup window.
<b>Cancel</b>	Closes the window without accepting your changes.
<b>Apply</b>	Accepts all your changes without closing the HW Setup window.

#### *General*

This window displays the BIOS version and contains two buttons:

<b>Default</b>	Return all HW Setup values to the factory settings.
<b>About</b>	Display the HW Setup version.

#### *Setup*

This field displays BIOS Version and date.

## ***Password***

This tab allows you to set or reset the user password for power on.

### ***User Password***

Lets you register a new password or un-register an existing password.

---

<b>Not Registered</b>	Un-registers an existing password
<b>Registered</b>	Register a new password by following the on screen instructions

---

### ***Owner String***

This blank field is used to display a message when the password field is displayed on startup. If a password is not registered the message will not be shown. The maximum length is 256 characters.

## ***Display***

This tab lets you select the internal LCD and/or external monitor when the computer boots up.

### ***Power On Display***

Lets you select the display to be used when the computer is booted (this setting is only available on Standard VGA mode and not available on Windows® Desktop).

---

<b>Auto-Selected</b>	Selects an external monitor if one is connected. Otherwise, it selects the internal LCD (Default).
<b>LCD + Analog RGB</b>	Selects both the internal LCD and external monitor for simultaneous display.

---

## ***Boot Priority***

### ***Boot Priority Options***

This option sets the priority for booting the computer.

To select the boot drive you want, follow the steps below.

1. Boot-up your computer and press **F12** to enter the boot menu.
2. The boot select screen will be displayed: Hard disk Drive, CD/DVD, FDD and LAN.
3. Use the upper/lower cursor keys to highlight the boot device you want and apply.



## Keyboard

### Wake-up on Keyboard

When this feature is enabled and the computer is in Sleep Mode, you can turn on the computer by pressing any key. It is effective only for the internal keyboard and only when the computer is in Sleep Mode.

<b>Enabled</b>	Enables the Wake-up on Keyboard function.
<b>Disabled</b>	Disables the Wake-up on Keyboard function (Default).

## USB

### USB Keyboard/Mouse/FDD Legacy Emulation

Use this option to enable or disable Legacy USB support. If your operating system does not support USB, you can still use a USB mouse, keyboard, and FDD by setting the Legacy USB Support to enable.

### USB Sleep and Charge function

This section describes the setting for "USB Sleep and Charge function". For more information, please refer to the [USB Sleep and Charge function](#) section in Chapter 4.

The default setting in BIOS Setup is [Disabled]. Changing the setting to [Enabled] enables the use of this function.

There are two modes, Mode -1 and Mode-2 in [Enabled]. For normal use, set the setting to Mode-1.



*If the function does not work with Mode-1 setting, change it to Mode-2. Some external devices may not be able to use this function in either mode. When this happens, change the setting to [Disabled].*

<b>Enabled (Mode-1)</b>	Enables USB Sleep and Charge function.
<b>Enabled (Mode-2)</b>	Enables USB Sleep and Charge function.
<b>Disabled</b>	Disables USB Sleep and Charge function (Default).

## LAN

### Built-in LAN

This feature enables or disables the Built-in LAN.

<b>Enabled</b>	Enables Built-in LAN function (Default).
<b>Disabled</b>	Disables Built-in LAN function.



# Chapter 8

## Optional Devices

Optional devices can expand the computer's capabilities and its versatility. This chapter describes connection or installation of the following devices, which are available from your TOSHIBA dealer:

### ***Cards/memory***

- ExpressCard
- SD (Secure Digital) / SDHC (Secure Digital High Capacity) / MMC (Multi Media Card) / MEMORY STICK / MEMORY STICK PRO / xD (xD-Picture Card) cards
- Memory expansion

### ***Power devices***

- Additional battery pack
- Additional AC adaptor

### ***Peripheral devices***

- External monitor

### ***Other***

- Security lock

## ExpressCard

The computer is equipped with an expansion slot that can accommodate one ExpressCard.

The ExpressCard expansion slot can accommodate two standard module formats: an ExpressCard/34 module and an ExpressCard/54 module. An ExpressCard module is a small, modular add-in card technology based on PCI Express and Universal Serial Bus (USB) interfaces.

### Inserting an ExpressCard

One ExpressCard connector is located on the right side of the computer. The computer's hot-install feature lets you install ExpressCard while the computer's power is on.

To install an ExpressCard, follow the steps below.

1. Insert the ExpressCard.
2. Press gently to ensure a firm connection.

Windows<sup>®</sup> hot-install feature lets you insert an ExpressCard while the computer's power is on.

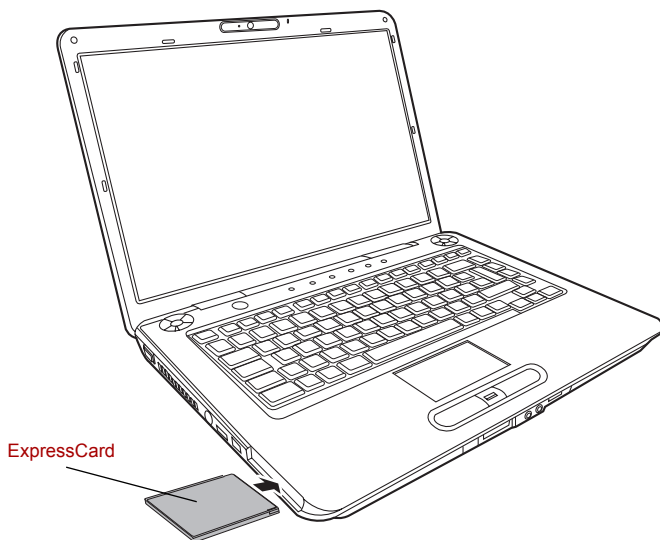

*Inserting the ExpressCard*

After inserting the card, refer to the card's documentation and check the configuration in Windows<sup>®</sup> to make sure it is appropriate for your card.

## Removing an ExpressCard



- Before removing an ExpressCard, make sure that any applications or system services do not use the card.
- Be sure to disable the ExpressCard prior to removing it. Otherwise, the system may be fatally damaged.

To remove the ExpressCard, follow the steps below.

1. Click the **Safety Remove Hardware** icon on the Task Bar.
2. Click the ExpressCard you want to remove.
3. Press the ExpressCard once to extend it.
4. Grasp the extended ExpressCard, and remove it.

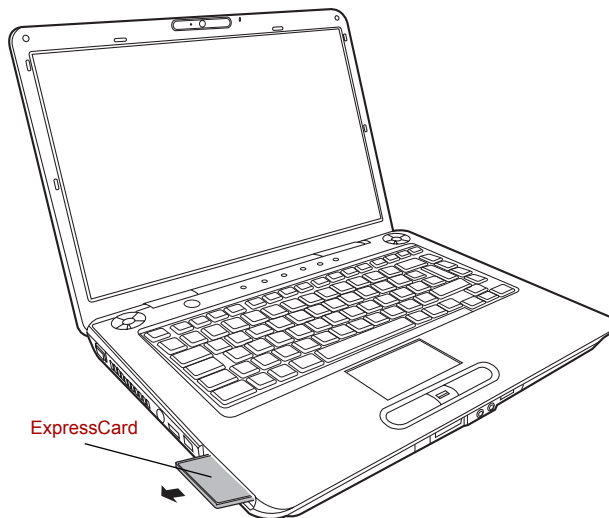

*Removing the ExpressCard*

## SD/SDHC/MMC/MEMORY STICK / MEMORY STICK PRO/xD Memory cards

The computer is equipped with a multiple digital media card slot that can accommodate SD/SDHC/MMC/MEMORY STICK / MEMORY STICK PRO/xD memory cards. These memory cards let you easily transfer data from devices, such as digital cameras and Personal Digital Assistants, which use flash-memory.

Card Type	Capacities
SD	up to 2GB
SDHC	up to 16GB
MMC	up to 2GB
MEMORY STICK	up to 128MB, 256MB (128MB x 2)
MEMORY STICK PRO	up to 4GB
xD	up to 2GB



*Keep foreign objects out of the memory card slot. A pin or similar object can damage the computer's circuitry.*



*Do not format a memory card with Windows® as it might result in that card not being able to be used with some peripheral devices.*



*Do not insert Memory Stick Duo/PRO Duo into the slot. Data may be lost or damaged if you use any card other than those supported.*



*The card is designed so that it can be inserted only one way. Do not try to force the card into the slot.*



*For more details on using memory cards, see manuals accompanying the cards.*



*The Logo of SD memory card is .*



*The Logo of SDHC memory card is .*

## Installing a memory card

To install a memory card:

1. Insert the memory card.
2. Press gently to ensure a firm connection.

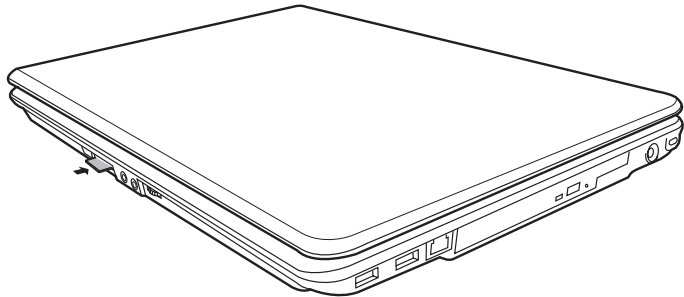

*Inserting a memory card*



*Be sure the memory card is oriented properly before you insert it.  
If Windows® fails to read the card, remove it then re-insert it.*



■ *The multiple digital media card slot only accepts one type of card at a time. Do not attempt to install more than one card as you risk damaging either the cards themselves or the computer.*

## Removing a memory card

To remove a memory card, follow the steps below:

1. Click the **Safely Remove Hardware** icon on the Taskbar.
2. Select a device, then click the **Stop** button. A confirmation dialog may appear, depending on how the device is registered with the system; if so, confirm that you want to remove the device.
3. Gently press the memory card inside the socket to eject it.
4. Grasp the card and remove it.

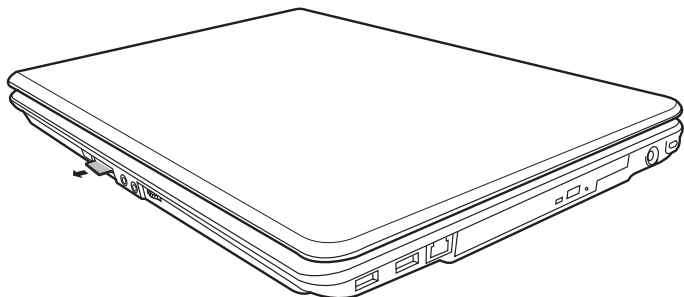

*Removing a memory card*



- *Make sure the memory card indicator is out before you remove the card or turn off the computer's power. If you remove the card or turn off the power while the computer is accessing the card you may lose data or damage the card.*
- *Do not remove the card while the computer is in Sleep or Hibernation mode. The computer could become unstable or data in the memory card could be lost.*
- *Do not turn off or place the computer into either Sleep Mode or Hibernation Mode while data is being transferred to or from the memory card. The system may become unstable or data in the memory card may be lost.*

## Memory card care



*Set the write-protect switch to the lock position, if you do not want to record data.*

1. Do not write to a memory card if the battery power is low. Low power could affect writing accuracy.
2. Do not remove a memory card while read/write is in progress.
3. The memory card is designed so that it can be inserted only one way. Do not try to force the card into the slot.
4. Do not leave a memory card partially inserted in the slot. Press the memory card until you hear it click into place.
5. Do not twist or bend memory cards.
6. Do not expose memory cards to liquids or store in humid areas or lay media close to containers of liquid.
7. After using a memory card, return it to its case.
8. Do not touch the metal part or expose it to liquids or let it get dirty.



## Memory expansion

You can install additional memory in the computer's memory module socket to increase the amount of RAM. This section describes how to install and remove a memory module.



- *Use only memory modules approved by TOSHIBA.*
- *Do not try to install or remove a memory module under the following conditions. You can damage the computer and the module. Also, data will be lost.*
  - a. *The computer is turned on.*
  - b. *The computer was shut down using the Sleep Mode or Hibernation Mode.*
- *When incorrect memory is inserted, please refer to [Memory expansion](#) section in Chapter 9, [Troubleshooting](#), for details.*
- *Expansion memory is a precision electronic component that may be fatally damaged by static electricity. Since the human body has slight static electricity, be sure to discharge static electricity from your body before installing an expansion memory module. To discharge your body's static electricity, simply touch any metal close to you with bare hands.*



*Use a point size 1 Phillips screwdriver to remove and fasten the screws. Use of an incorrect screwdriver can damage the screw heads.*

### Installing a memory module

Follow the steps below to install a memory module.

1. Set the computer to boot mode and turn off the power.
2. Remove all cables connected to the computer.
3. Turn the computer upside down and remove the battery pack (refer to Chapter 6, [Power and Power-Up Modes](#)).
4. Loosen the screws securing the memory module cover.
5. Slide your fingernail or a thin object under the cover and lift it off.

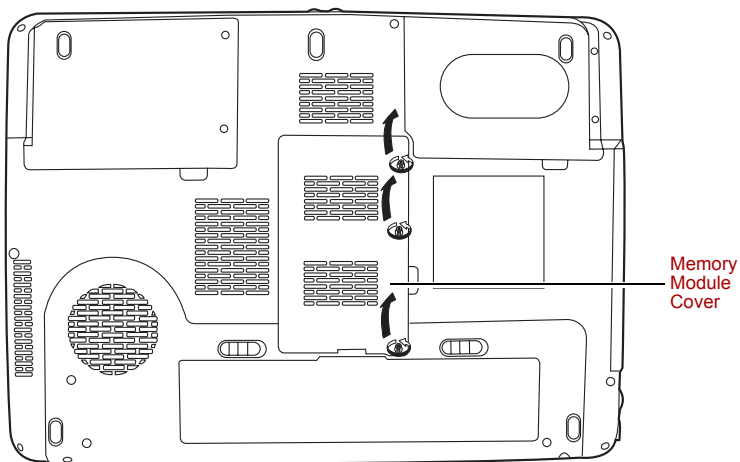

*Removing the memory module cover*

6. Lift one side of the insulator sheet and fit the module's connectors into the computer's connectors at about a 45 degree angle. Press the module carefully to ensure a firm connection.



*Do not touch the connectors on the memory module or on the computer. Debris on the connectors may cause memory access problems.*



*Slot A is reserved for main memory. Use slot B for expanded memory. If only one card is installed use slot A.*

7. Push the module down so it lies flat. Latches on either side will click into place to secure the module.

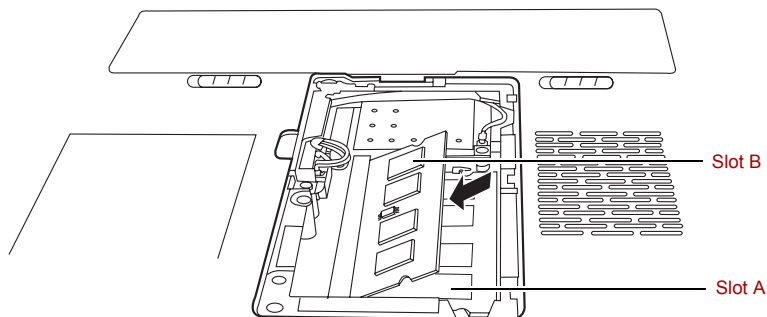

*Installing the memory module*

8. Seat the cover and secure it with the screws.
9. Replace the battery pack as described in Chapter 6, *Power and Power-Up Modes*.
10. Turn the power on and make sure the added memory is recognized. Open **System** in the Control Panel and click the **General** tab.

### **Points to note about memory module error**

If you install a memory module that is not compatible with the computer, the Power indicator will flash (on for 0.5 seconds, off for 0.5 seconds) in the following ways:

- If there is only an error in Slot A: repeatedly flashes orange twice, then blue.
- If there is only an error in Slot B: repeatedly flashes orange, then blue twice.
- If there is an error in Slot A and in Slot B: repeatedly flashes orange twice, then blue twice.

In all instances you should shut down the computer and remove the incompatible module(s).

### **Removing a memory module**

To remove the memory module, make sure the computer is in boot mode then:

1. Be sure the power is off and all cables are disconnected from the computer.
2. Turn the computer upside down and remove the battery and the screws securing the memory module cover.
3. Slide your fingernail or a thin object under the cover and lift it off.
4. Lift one side of the insulator and push the latches to the outside to release the module. A spring will force one end of the module up.
5. Grasp the module by the sides and pull it out.



- *If you use the computer for a long time, the memory modules will become hot. In this case, let the memory modules cool to room temperature before you replace them. Or you will get burnt if you touch any of them.*
- *Do not touch the connectors on the memory module or on the computer. Debris on the connectors may cause memory access problems.*

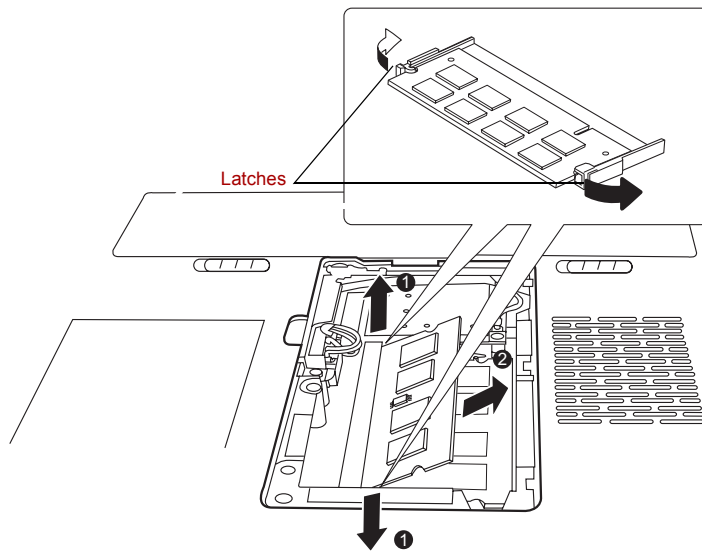

*Removing the memory module*

6. Seat the cover and secure it with screws and replace the battery pack.

## **Additional battery pack**

You can increase the portability of the computer with additional battery packs. If you're away from an AC power source and your battery runs low, you can replace it with a freshly charged battery. Refer to Chapter 6, [Power and Power-Up Modes](#).

## **Additional AC adaptor**

If you frequently transport the computer between different sites such as your home and office, purchasing an AC adaptor for each location will reduce the weight and bulk of your carrying load.

## External monitor

An external analog monitor can be connected to the external monitor port on the computer. The computer supports several video modes. Refer to Appendix B, *Display Controller and Modes*. To connect a monitor, follow the steps below.

1. Turn the computer off.
2. Connect the monitor to the external monitor port.
3. Turn the monitor's power on.
4. Turn the computer on.

When you turn on the power, the Windows® Bootup screen (Windows® Logo) appears on the display device.

However, the Windows® Desktop appears on a display device that you used last time to shut down your PC, if the display device exists when you turn on the power.

To change the display settings, press **Fn+F5**. If you disconnect the monitor before you turn the computer off, be sure to press **Fn+F5** to switch to the internal display. Refer to Chapter 5, *The Keyboard*, for details on using hot keys to change the display setting.

## Television

A television can be connected to the video out port on the computer. To connect a television, follow the steps below.

1. Turn the computer off.
2. Use a video cable (not supplied) to connect the television to the TV out port.

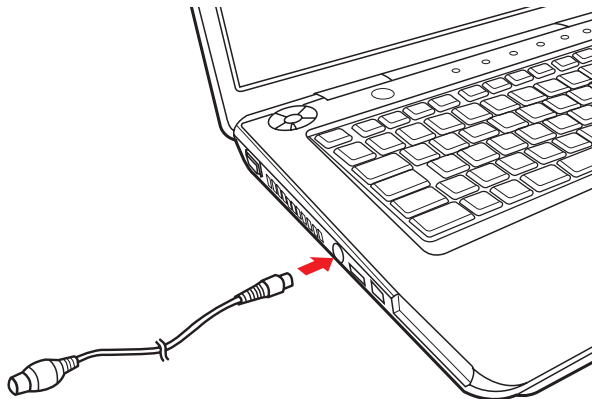

*Connecting a television*

3. Turn the television on.
4. Turn the computer on.

## HDMI

A HDMI monitor can be connected to the HDMI out port on the computer. 1080p, 1080i, 720p, 576p and 480p signal formats can be supported. But actual signal format you can use depends on HDMI monitor. To connect monitor, follow the steps as detailed below:



*As the port operation of all HDMI (High-Definition Multimedia Interface) monitors has not been confirmed, some HDMI monitors may not function properly.*

1. Plug one end of the HDMI cable into the HDMI port of the HDMI device.

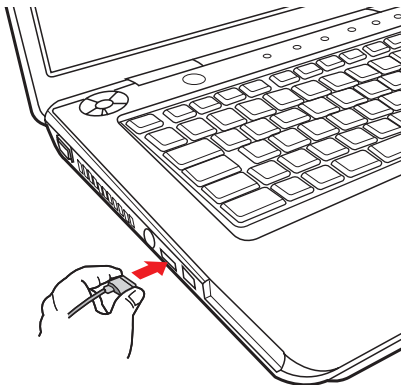

*Connecting a HDMI cable*

2. Plug the other end of the HDMI cable into the HDMI out port on your computer.

### Setting for display video on HDMI

To view video on the HDMI device, be sure to configure the following settings otherwise you may find that nothing is displayed.



- *Be Sure to use the **FN + F5** hot keys to select the display device before starting to play video. Do not change the display device while playing video.*
- *Do not change the display device under the following conditions.*
- *While data is being read or written.*
- *While communication is being carried out.*

### Settings for audio on HDMI

To set the audio device to use the HDMI, follow the steps below.

1. Click Start.
2. Click Control Panel.
3. Click Hardware and Sound.

4. Click Sound.
5. Click Digital Output Device (HDMI).
6. Click the Set Default Device button.

To set the audio device to use internal speaker, follow the steps below.

1. Click Start.
2. Click Control Panel.
3. Click Hardware and Sound.
4. Click Sound.
5. Click Speakers.
6. Click the Set Default Device button.

## i.LINK (IEEE1394)

i.LINK (IEEE1394) is used for high-speed data transfer for a range of compatible devices such as

1. Digital video cameras
2. Hard disk drives
3. MO drives
4. CD-RW drives



*i.LINK uses a four-pin connector, which does not carry electric current. External devices will need their own power supply.*

## Precautions

1. Make a back-up of your data before transferring it to the computer. There is a possibility that the original data will be damaged. There is a particular risk that some frames will be deleted in the case of digital video transfer. TOSHIBA assumes no liability for such loss of data.
2. Do not transfer data in areas where static electricity is easily generated or in areas subjected to electronic noise. Data can be destroyed.
3. If you are transferring data through an IEEE1394 hub, do not connect or disconnect other devices from the hub during data transfer. There is a likelihood that data will be damaged. Connect all devices to the hub before you turn on the computer's power.
4. You may not use any copyrighted video or music data copied from a video camera except for your personal enjoyment.
5. If you connect/disconnect an i.LINK device to/from another i.LINK device that is currently exchanging data with the computer, data frames might be dropped.
6. Make sure data transfer has ended or turn off the computer, before you:
  - a. Connect/disconnect an i.LINK device to/from the computer.
  - b. Connect/disconnect an i.LINK device to/from another i.LINK device that is connected to the computer.

## Connecting

1. Make sure the connectors are properly aligned and plug the i.LINK (IEEE1394) cable into the computer.
2. Plug the other end of the cable into the device.  
Note the following when you use i.LINK:
  - a. You may need to install drivers for your i.LINK devices.
  - b. Not all i.LINK devices have been tested. Therefore, compatibility with all i.LINK devices cannot be guaranteed.
  - c. Use S100, S200 or S400 cables no longer than three meters.
  - d. Some devices might not support sleep or automatic off functions.
  - e. Do not connect or disconnect an i.LINK device while it is using an application or when the computer is automatically shutting it down to save power. Data might be destroyed.
  - f. When multiple IEEE1394 devices are connected to a PC, the devices may not correctly be identified. This problem may occur when Windows Vista is restarted while the devices are connected or when the power to the IEEE1394 devices is turned on before the PC is turned on. If it occurs, disconnect the IEEE1394 cables and then reconnect them.

## Disconnecting

1. Open the **Safety Remove Hardware** icon on the Task Bar.
2. Point to **i.LINK (IEEE1394) device** and click.
3. Disconnect the cable from the computer then from the i.LINK device.



*Refer also to the documentation that came with your i.LINK device.*



## Security lock

Security locks enable you to anchor your computer to a desk or other heavy object to help prevent unauthorized removal of the computer.

The computer has a security lock slot on the left side. Attach one end of the cable to a desk and the other end to the security lock slot.

1. Turn the computer so the left side faces you.
2. Align the holes for the security lock and attach the lock.

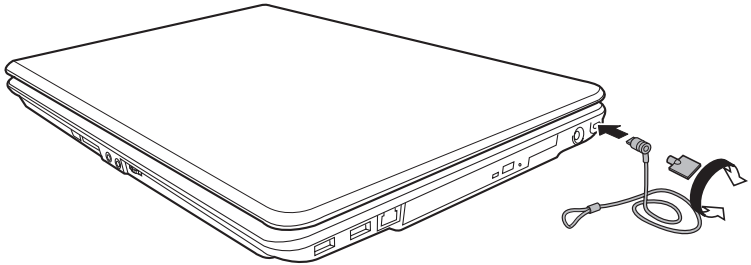

*Security lock*



## Chapter 9

### Troubleshooting

TOSHIBA designed the computer for durability. However, should problems occur, following the procedures in this chapter can help to determine the cause.

All readers should become familiar with this chapter. Knowing what might go wrong can help prevent problems from occurring.

#### Problem solving process

Resolving problems will be much easier if you observe the following guidelines:

- Stop immediately when you recognize a problem exists. Further action may result in data loss or damage. You may destroy valuable problem related information that can help solve the problem.
- Observe what is happening. Write down what the system is doing and what actions you performed immediately before the problem occurred. If you have a printer attached, print a copy of the screen using PrtSc.

The questions and procedures offered in this chapter are meant as a guide, they are not definitive problem solving techniques. Many problems can be solved simply, but a few may require help from your dealer. If you find you need to consult your dealer or others, be prepared to describe the problem in as much detail as possible.

## Preliminary checklist

Consider the simplest solution first. The items in this checklist are easy to fix and yet can cause what appears to be a serious problem.

- Make sure you turn on all peripheral devices before you turn on the computer. This includes your printer and any other external device you are using.
- Before you attach an external device, turn the computer off. When you turn the computer back on it recognizes the new device.
- Make sure all options are set properly in the setup program.
- Check all cables. Are they correctly and firmly attached? Loose cables can cause signal errors.
- Inspect all connecting cables for loose wires and all connectors for loose pins.
- Check that your CD/DVD/CD-RW/HD DVD-R is correctly inserted.

Make notes of your observations and keep them in a permanent error log. This will help you describe your problems to your dealer. If a problem recurs, the log will help you identify the problem faster.

## Analyzing the problem

Sometimes the system gives clues that can help you identify why it is malfunctioning. Keep the following questions in mind:

- Which part of the system is not operating properly: keyboard, hard disk drive, optical media drive, display. Each device produces different symptoms.
- Is the operating system configuration set properly? Check the configuration options.
- What appears on the display screen? Does it display any messages or random characters? Print a copy of the screen if you have a printer attached. Look up the messages in the software and operating system documentation. Check that all connecting cables are correctly and firmly attached. Loose cables can cause erroneous or intermittent signals.
- Do any indicators light? Which ones? What color are they? Do they stay on or blink? Write down what you see.
- Do you hear any beeps? How many? Are they long or short? Are they high pitched or low? Is the computer making any unusual noises? Write down what you hear.

Record your observations so you can describe them to your dealer.

Software	<p>The problems may be caused by your software or disc. If you cannot load a software package, the media may be damaged or the program might be corrupted. Try loading another copy of the software.</p> <p>If an error message appears while you are using a software package, check the software documentation. These documents usually include a problem solving section or a summary of error messages.</p> <p>Next, check any error messages in the operating system documentation.</p>
Hardware	<p>If you cannot find a software problem, check your hardware.</p> <p>First run through the items in the preliminary checklist above. If you still cannot correct the problem, try to identify the source. The next section provides checklists for individual components and peripherals.</p>

## Hardware and system checklist

This section discusses problems caused by your computer's hardware or attached peripherals. Basic problems may occur in the following areas:

- System start-up
- Self test
- Power
- Real Time Clock
- Keyboard
- LCD panel
- Hard disk drive
- DVD Super Multi drive
- HD DVD-ROM drive
- HD DVD-RW drive
- Pointing device
- USB
- Memory expansion
- Sound system
- Monitor
- Modem
- LAN
- Wireless LAN
- FingerPrint Sensor
- ExpressCard

### System start-up

When the computer does not start properly, check the following items:

- Self Test
- Power Sources
- Power-on Password

## Self test

When the computer starts up, the self test will be run automatically, and the following will be displayed:



TOSHIBA Leading Innovation >>>

This message remains on the screen for a few seconds.

If the self test is successful, the computer tries to load the operating system, depending on how the Boot Priority is set in the TOSHIBA HW Setup program.

If any of the following conditions are present, the self test failed:

- The computer stops and does not proceed to display information or messages except the TOSHIBA logo.
- Random characters appear on the screen, and the system does not function normally.
- The screen displays an error message.

Turn off the computer and check all cable connections. If the test fails again, contact your dealer.

## Power

When the computer is not plugged into an AC outlet, the battery pack is the primary power source. However, your computer has a number of other power resources, including an intelligent power supply and a Real Time Clock battery. These resources are interrelated and any one could affect apparent power problems. This section provides checklists for AC power and the battery. If you cannot resolve a problem after following them, the cause could lie with another power resource. In such a case, contact your dealer.

### ***Overheating power down***

If the computer's internal temperature becomes too high, the computer will automatically enter Hibernation Mode or Sleep Mode and shut down. If the computer has reached room temperature and still does not start, or if it starts but shuts down quickly contact your dealer.

## AC power

If you have trouble turning on the computer with the AC adaptor connected, check the **Battery** indicator. Refer to Chapter 6, *Power and Power-Up Modes* for more information.

Problem	Procedure
AC adaptor doesn't power the computer	<p>Check the connections. Make sure the cord is firmly connected to the computer and a power outlet.</p> <hr/> <p>Check the condition of the cord and terminals. If the cord is frayed or damaged, replace it. If the terminals are soiled, wipe them with cotton or a clean cloth.</p> <hr/> <p>If the AC adaptor still does not power the computer, contact your dealer.</p>

## Battery

If you suspect a problem with the battery, check the **Battery** indicator. For information on indicator and battery operation refer to Chapter 6, *Power and Power-Up Modes*.

Problem	Procedure
Battery doesn't power the computer	The battery may be discharged. Connect the AC adaptor to charge the battery.
Battery doesn't charge when the AC adaptor is attached ( <b>Battery</b> indicator does not glow orange.)	<p>If the battery is completely discharged, it will not begin charging immediately. Wait a few minutes.</p> <p>If the battery still does not charge, make sure the outlet of the AC adaptor is supplying power.</p> <p>Test it by plugging in an appliance.</p> <hr/> <p>Check whether the battery is hot or cold to the touch. If the battery is too hot or too cold, it will not charge properly. Let it reach room temperature.</p>

Problem	Procedure
	<p>Unplug the AC adaptor and remove the battery to make sure the terminals are clean. If necessary wipe them with a soft dry cloth dipped in alcohol.</p> <p>Connect the AC adaptor and replace the battery. Make sure it is securely seated.</p> <p>Check the <b>Battery</b> indicator. If it does not glow, let the computer charge the battery for at least 20 minutes. If the <b>Battery</b> indicator glows after 20 minutes, let the battery continue to charge at least another 20 minutes before turning on the computer.</p> <p>If the indicator still does not glow, the battery may be at the end of its operating life. Replace it.</p> <p>If you do not think the battery is at the end of its operating life, see your dealer.</p>
<p>Battery doesn't power the computer as long as expected</p>	<p>If you frequently recharge a partially charged battery, the battery might not charge to its full potential. Fully discharge the battery, then try to charge it again.</p> <hr/> <p>Check the power consumption settings in the Power Options. Consider using a power saving feature.</p>

## Disposing of PC and PC batteries

- Discard this PC in accordance with applicable laws and regulations. For further information, contact your local government.
- This PC contains rechargeable batteries. After repeated use, the batteries will finally lose their ability to hold a charge and you will need to replace them. Under certain applicable laws and regulation, it may be illegal to dispose of old batteries by placing them in the trash.
- Please be kind to our shared environment. Check with your local government authority for details regarding where to recycle old batteries or how to dispose of them properly. This product contains mercury. Disposal of this material may be regulated due to environmental considerations. For disposal, reuse or recycling information, please contact your local government.
- If your hard disk or other storage media contains sensitive data, you should be aware that standard deletion procedures do not remove data from the media. These standard deletion procedures include:
  - Selecting Delete for a target file
  - Putting files in the Recycle Bin and emptying the Recycle Bin



- Reformatting the media
- Reinstalling an operating system from the recovery CD-ROM

The procedures above delete only the initial part of the data used for file management. This makes the file invisible to the operating system, but the data can still be read by specialized utilities. If you dispose of the PC, please delete all the data on its hard disk drive. Doing so prevents unauthorized use of such data. To ensure your data is not used for unauthorized purposes, you can:

- Physically destroy the hard disk drive
- Use a proven specialized utility to overwrite all data
- Take the hard disk drive to a professional deletion service

## Real Time Clock

Problem	Procedure
The BIOS setting and system date/time are lost.	<p>Charge in the RTC battery is exhausted or getting low. You will need to set the date and time in the BIOS setup screen using the following procedure</p> <ol style="list-style-type: none"> <li>1. Press <b>F2</b> key. BIOS setup will boot up.</li> <li>2. Set the date in <b>System Date</b>.</li> <li>3. Set the time in <b>System Time</b>.</li> <li>4. Press <b>F10</b> key. Confirmation message will appear.</li> <li>5. Press <b>Enter</b> key. BIOS setup will terminate and the computer will be rebooted.</li> </ol>



*After configuring the time and date for the Real Time Clock battery, we recommend that you turn the power status of your computer to "ON" so that the Real Time Clock battery is charged.*

## Keyboard

Keyboard problems can be caused by your setup configuration. For more information refer to Chapter 5, [The Keyboard](#).

Problem	Procedure
Some letter keys produce numbers	Check that the numeric keypad overlay is not selected. Press <b>Fn + F11</b> and try typing again.
Output to screen is garbled	<p>Make sure the software you are using is not remapping the keyboard. Remapping involves reassigning the meaning of each key. Refer to your software's documentation.</p> <p>If you are still unable to use the keyboard, consult your dealer.</p>

## LCD panel

Apparent LCD problems may be related to the computer's setup.

Problem	Procedure
No display	Press hot keys <b>Fn + F5</b> to change the display priority, to make sure it is not set for an external monitor.
Problems above remain unresolved or other problems occur	Refer to your software's documentation to determine if the software is causing the difficulty. Run the diagnostic test. Contact your dealer if the problems continue.

## Hard disk drive

Problem	Procedure
Computer does not boot from hard disk drive	There may be a problem with your operating system files. Refer to your operating system documentation.
Slow performance	Your files may be fragmented. Run disk Defragmenter to check the condition of your files and disk. Refer to your operating system documentation or online help for information on running disk Defragmenter. As a last resort, reformat the hard disk. Then, reload the operating system and other files. If problems persist, contact your dealer.

## DVD Super Multi drive (Supporting DVD±R DL)

For more information, refer to Chapter 4, *Operating Basics*.

Problem	Procedure
<p>You cannot access a CD/DVD in the drive</p>	<p>Make sure the drive's drawer is securely closed. Press gently until it clicks into place.</p> <hr/> <p>Open the drawer and make sure the CD/DVD is properly seated. It should lie flat with the label facing up.</p> <hr/> <p>A foreign object in the drawer could block laser light from reading the CD/DVD. Make sure there is no obstruction. Remove any foreign object.</p> <hr/> <p>Check whether the CD/DVD is dirty. If it is, wipe it with a clean cloth dipped in water or a neutral cleaner. Refer to the <i>Media care</i> section in Chapter 4, <i>Operating Basics</i>, for details on cleaning.</p>
<p>Some CD/DVDs run correctly, but others do not</p>	<p>The software or hardware configuration may be causing a problem. Make sure the hardware configuration matches your software's needs. Check the CD/DVD documentation.</p> <hr/> <p>Check the type of CD/DVD you are using. The drive supports:</p> <p>DVD-ROM: DVD-ROM, DVD-Video, DVD-R, DVD-RW, DVD+R, DVD+RW, DVD-RAM, HD DVD-ROM</p> <p>CD-ROM: CD-DA, CD-Text, Photo CD (single/multi-session), CD-ROM Mode 1, Mode 2, CD-ROM XA Mode 2 (Form1, Form2), Enhanced CD (CDEXTRA)</p> <p>Recordable Disc: CD-R, CD-RW, DVD-R, DVD-R(DL), DVD-RW, DVD+R, DVD+R(DL), DVD+RW, DVD-RAM, HD DVD-R</p> <hr/> <p>Check the region code on the DVD. It must match that on the DVD Super Multi drive. Region codes are listed in the <i>Optical Disc Drive</i> section in Chapter 2, <i>The Grand Tour</i>.</p>

Problem	Procedure
Cannot write correctly	<p>If you have trouble writing, make sure you are observing the following precautions:</p> <p>Use only media recommended by TOSHIBA Do not use the mouse or keyboard during writing.</p> <p>Use only the software supplied with the computer for recording.</p> <p>Do not run or start other software during writing.</p> <p>Do not jar the computer during writing.</p> <p>Do not connect/disconnect external devices or install/remove internal cards during writing. If problems persist, contact your dealer.</p>

---

### HD DVD ROM drive

For more information, refer to Chapter 4, *Operating Basics*.

Problem	Procedure
You cannot access a CD/DVD/HD DVD in the drive	<p>Make sure the drive's drawer is securely closed. Press gently until it clicks into place.</p> <hr/> <p>Open the drawer and make sure the CD/DVD/HD DVD is properly seated. It should lie flat with the label facing up.</p> <hr/> <p>A foreign object in the drawer could block laser light from reading the CD, DVD or HD DVD. Make sure there is no obstruction. Remove any foreign object.</p> <hr/> <p>Check whether the media is dirty. If it is, wipe it with a clean cloth dipped in water or a neutral cleaner. See the <i>Media care</i> section in Chapter 4 for details on cleaning.</p>

---

Problem	Procedure
Some CD/DVDs run correctly, but others do not	<p data-bbox="518 165 1046 277">The software or hardware configuration may be causing a problem. Make sure the hardware configuration matches your software's needs. Check the CD/DVD's documentation.</p> <hr data-bbox="518 277 1046 280"/> <p data-bbox="518 293 1046 341">Check the type of DVD/CD you are using. The drive supports:</p> <p data-bbox="518 357 1046 381">HD DVD-ROM:</p> <ul data-bbox="518 389 1046 453" style="list-style-type: none"><li data-bbox="518 389 1046 421">■ HD DVD-ROM, HD DVD-R,</li><li data-bbox="518 421 1046 453">■ HD DVD-RW</li></ul> <p data-bbox="518 461 1046 485">DVD-ROM:</p> <ul data-bbox="518 493 1046 588" style="list-style-type: none"><li data-bbox="518 493 1046 525">■ DVD-ROM, DVD-Video,</li><li data-bbox="518 525 1046 557">■ DVD-R, DVD-RW, DVD+R,</li><li data-bbox="518 557 1046 588">■ DVD+RW, DVD-RAM</li></ul> <p data-bbox="518 596 1046 620">CD-ROM:</p> <ul data-bbox="518 628 1046 788" style="list-style-type: none"><li data-bbox="518 628 1046 692">■ CD-DA, CD-Text, Photo CD (single/multi-session),</li><li data-bbox="518 692 1046 724">■ CD-ROM Mode 1, Mode 2,</li><li data-bbox="518 724 1046 756">■ CD-ROM XA Mode 2 (Form1, Form2),</li><li data-bbox="518 756 1046 788">■ Enhanced CD (CDEXTRA)</li></ul> <p data-bbox="518 804 1046 828">Recordable Disk:</p> <ul data-bbox="518 836 1046 963" style="list-style-type: none"><li data-bbox="518 836 1046 868">■ CD-R, CD-RW, DVD-R,</li><li data-bbox="518 868 1046 900">■ DVD-R(DL), DVD-RW,</li><li data-bbox="518 900 1046 932">■ DVD+R, DVD+R(DL),</li><li data-bbox="518 932 1046 963">■ DVD+RW, DVD-RAM</li></ul> <hr data-bbox="518 963 1046 967"/> <p data-bbox="518 979 1046 1091">Check the region code on the DVD. It must match that on the drive. Region codes are listed in the Optical disc section in Chapter 2, <a href="#">The Grand Tour</a>.</p>

Problem	Procedure
Cannot write correctly	<p>If you have trouble writing, make sure you are observing the following precautions:</p> <p>Use only media recommended by TOSHIBA Do not use the mouse or keyboard during writing.</p> <p>Use only the software supplied with the computer for recording.</p> <p>Do not run or start other software during writing.</p> <p>Do not jar the computer during writing.</p> <p>Do not connect/disconnect external devices or install/remove internal cards during writing. If problems persist, contact your dealer.</p>

---

### HD DVD-RW drive

For more information, refer to Chapter 4, *Operating Basics*.

Problem	Procedure
You cannot access a CD/DVD/HD DVD in the drive	<p>Make sure the drive's drawer is securely closed. Press gently until it clicks into place.</p> <hr/> <p>Open the drawer and make sure the CD/DVD/HD DVD is properly seated. It should lie flat with the label facing up.</p> <hr/> <p>A foreign object in the drawer could block laser light from reading the CD, DVD or HD DVD. Make sure there is no obstruction. Remove any foreign object.</p> <hr/> <p>Check whether the media is dirty. If it is, wipe it with a clean cloth dipped in water or a neutral cleaner. See the <i>Media care</i> section in Chapter 4 for details on cleaning.</p>



---

Problem	Procedure
Some CD/DVD/HD DVD run correctly, but others do not	<p>The software or hardware configuration may be causing a problem. Make sure the hardware configuration matches your software's needs. Check the CD/DVD/HD DVD documentation.</p> <hr/> <p>Check the type of DVD/CD you are using. The drive supports:</p> <p>HD DVD-ROM:</p> <ul style="list-style-type: none"> <li>■ HD DVD-ROM, HD DVD-R,</li> <li>■ HD DVD-RW</li> </ul> <p>DVD-ROM:</p> <ul style="list-style-type: none"> <li>■ DVD-ROM, DVD-Video,</li> <li>■ DVD-R, DVD-RW, DVD+R,</li> <li>■ DVD+RW, DVD-RAM</li> </ul> <p>CD-ROM:</p> <ul style="list-style-type: none"> <li>■ CD-DA, CD-Text, Photo CD (single/multi-session),</li> <li>■ CD-ROM Mode 1, Mode 2,</li> <li>■ CD-ROM XA Mode 2 (Form1, Form2),</li> <li>■ Enhanced CD (CDEXTRA)</li> </ul> <p>Recordable Disk:</p> <ul style="list-style-type: none"> <li>■ CD-R, CD-RW, DVD-R,</li> <li>■ DVD-R(DL), DVD-RW,</li> <li>■ DVD+R, DVD+R(DL),</li> <li>■ DVD+RW, DVD-RAM,</li> <li>■ HD DVD-R, HD DVD-RW</li> </ul> <hr/> <p>Check the region code on the DVD. It must match that on the CD-RW/DVD-ROM drive. Region codes are listed in the Optical disc section in Chapter 2, <i>The Grand Tour</i>.</p>
Cannot write correctly	<p>If you have trouble writing, make sure you are observing the following precautions:</p> <p>Use only media recommended by TOSHIBA Do not use the mouse or keyboard during writing.</p> <p>Use only the software supplied with the computer for recording.</p> <p>Do not run or start other software during writing.</p> <p>Do not jar the computer during writing.</p> <p>Do not connect/disconnect external devices or install/remove internal cards during writing. If problems persist, contact your dealer.</p>

## Pointing device

If you are using a USB mouse, also refer to the USB section in this chapter and to your mouse documentation.

### TouchPad

Problem	Procedure
On-screen pointer does not respond to Pad operation	The system might be busy. If the pointer is shaped as an hourglass, wait for it to return to its normal shape and try again to move it.
Double-tapping does not work	<p>Try changing the double-click speed setting in the mouse control utility.</p> <ol style="list-style-type: none"> <li>1. To access this utility, click , <b>Control Panel, Hardware and Sound</b>, then <b>Mouse</b> icon.</li> <li>2. Within the Mouse Properties window, click the <b>Buttons</b> tab.</li> <li>3. Set the double-click speed as required and click <b>OK</b>.</li> </ol>
The mouse pointer moves too fast or too slow	<p>Try changing the speed setting in the mouse control utility.</p> <ol style="list-style-type: none"> <li>1. To access this utility, click , <b>Control Panel, Hardware and Sound</b>, then <b>Mouse</b> icon.</li> <li>2. Within the Mouse Properties window, click the <b>Pointer Options</b> tab.</li> <li>3. Set the pointer speed as required and click <b>OK</b>.</li> </ol>



Problem	Procedure
The response of the TouchPad is too sensitive	<p>Adjust the touch sensitivity.</p> <ol style="list-style-type: none"> <li>1. Click , <b>Control Panel, Hardware and Sound</b>, then <b>Mouse</b> icon.</li> <li>2. Within the Mouse Properties window, click the <b>Device Settings</b> tab.</li> <li>3. Click the <b>Settings</b> button.</li> <li>4. The Properties for Synaptics Touchpad on PS/2 port screen appears. Double-click <b>Sensitivity</b> in the Select an item section on the left side of the screen.</li> <li>5. PalmCheck and Touch Sensitivity are displayed. Click <b>Touch Sensitivity</b>.</li> <li>6. Move the slide bar for Touch Sensitivity to make an adjustment. Click the <b>OK</b> button.</li> <li>7. Click the <b>OK</b> button on the Device Setting tab.</li> </ol>

### USB mouse

Problem	Procedure
On-screen pointer does not respond to mouse operation	<p>The system might be busy. If the pointer is shaped as an hourglass, wait for it to resume its normal shape and try again to move it.</p> <hr/> <p>Make sure the mouse is properly connected to the USB port.</p>
Double-clicking does not work	<p>Try changing the double-click speed setting in the mouse control utility.</p> <ol style="list-style-type: none"> <li>1. To access this utility, click , <b>Control Panel, Hardware and Sound</b>, then <b>Mouse</b> icon.</li> <li>2. Within the Mouse Properties window, click the <b>Buttons</b> tab.</li> <li>3. Set the double-click speed as required and click <b>OK</b>.</li> </ol>

Problem	Procedure
<p>The mouse pointer moves too fast or too slow</p>	<p>Try changing the speed setting in the mouse control utility.</p> <ol style="list-style-type: none"> <li>1. To access this utility, click , <b>Control Panel</b>, <b>Hardware and Sound</b>, then <b>Mouse</b> icon.</li> <li>2. Within the Mouse Properties window, click the <b>Pointer Options</b> tab.</li> <li>3. Set the pointer speed as required and click <b>OK</b>.</li> </ol>
<p>The mouse pointer moves erratically</p>	<p>The mouse might be dirty. Refer to your mouse documentation for instructions on cleaning. If problems persist, contact your dealer.</p>

## USB

Also refer to your USB device's documentation.

Problem	Procedure
<p>USB device does not work</p>	<p>Check for a firm cable connection between the USB ports on the computer and the USB device.</p> <p>Make sure the USB device drivers are properly installed. Refer to your Windows® Vista documentation for information on checking the drivers.</p> <p>If problems persist, contact your dealer.</p>

## USB Sleep and Charge function

Problem	Procedure
<p>I cannot use the "USB Sleep and Charge function".</p>	<p>The setting of "USB Sleep and Charge function" may be [Disabled]. Change the setting to [Enabled] in the HW Setup.</p> <hr/> <p>When there is a current overflow of the external device connected to the compatible port, USB bus power (DC5V) supply may be stopped for safety reasons. When the happens, disconnect an external device if some external devices are connected. After that, turn the power of the computer ON/OFF to restore the function. If this function can not be still used even if only one external device is connected, stop using the external device because its current is over the acceptable value of this computer.</p> <hr/> <p>Some external devices may not be able to use the "USB Sleep and Charge function.". In this case, please try one or more of the following methods.</p> <ul style="list-style-type: none"> <li>■ Change a mode setting of [Enabled] by the HW Setup.</li> <li>■ Turn OFF the computer while external devices are connected.</li> </ul> <p>If this function can not be still used, change the setting to [Disabled] in the BIOS Setup and stop using the function.</p>
<p>The battery depletes quickly even when I turned OFF the power of the computer.</p>	<p>When "USB Sleep and Charge function" is set to [Enabled] in the HW Setup, USB bus power (DC5V) will be supplied to the external device connected to the compatible port. If external device is connected to the compatible port when the AC adaptor is not connected to the computer, the battery of the computer will be depleted even when the power of the computer is turned OFF.</p> <p>Connect the AC adaptor to the computer or change the "USB Sleep and Charge function" setting the [Disabled] in the HW Setup.</p> <p>Instead use an USB Port the does not have the USB Sleep and Charge function-compatible icon (⚡).</p>

Problem	Procedure
<p>External devices connected to the compatible ports do not work when connected to a compatible port.</p>	<p>Some external devices may not work when connected to a compatible port when the "USB Sleep and Charge function" is [Enabled] in the HW Setup.</p> <p>Reconnect the external device after turning ON the computer.</p> <p>If the external device still does not work, connect device to an USB port that does not have the USB Sleep and Charge function-compatible icon (⚡) or change the "USB Sleep and Charge function" setting to [Disabled] in the HW Setup.</p>
<p>The "USB WakeUp function" does not work</p>	<p>When "USB Sleep and Charge function" is set to [Enabled] in the HW Setup, the "USB WakeUp function" does not work for ports that support the USB Sleep and Charge function.</p> <p>In that case, use an USB port that does not have the USB Sleep and Charge function-compatible icon (⚡) or change the "USB Sleep and Charge function" setting to [Disabled ] in the HW Setup.</p>

## Memory expansion

Refer also to Chapter 8, *Optional Devices*, for information on installing memory modules.

Problem	Procedure
<p>The computer hangs up</p>	<p>Make sure the memory module installed in the expansion slot is compatible with the computer.</p> <p>If an incompatible module has been installed, follow the steps below.</p> <ol style="list-style-type: none"> <li>1. Turn off the power.</li> <li>2. Disconnect the AC adaptor and all peripheral devices.</li> <li>3. Remove the battery pack.</li> <li>4. Remove the memory module.</li> <li>5. Replace the battery pack and/or connect the AC adaptor.</li> <li>6. Turn on the power.</li> </ol> <p>If problems persist, contact your dealer.</p>

## Sound system

Refer also to documentation for your audio devices.

Problem	Procedure
No sound is heard	Check the software volume settings. Make sure the headphone connection is secure. If problems persist, contact your dealer.

## Monitor

Refer also to Chapter 8, *Optional Devices*, and to your monitor's documentation.

Problem	Procedure
Monitor does not turn on	Make sure that the external monitor's power switch is on. Confirm that the external monitor's power cable is plugged into a working power outlet.
No display	Try adjusting the contrast and brightness controls on the external monitor. Press hot keys <b>Fn + F5</b> to change the display priority and make sure it is not set for the internal display.
Display error occurs	Check that the cable connecting the external monitor to the computer is attached firmly. If problems persist, contact your dealer.

## Modem

Problem	Procedure
Communication software can't initialize modem	Make sure the computer's internal modem settings are correct. Refer to Phone and Modem Properties in the Control Panel.
You can hear a dial tone but can't make a call	If the call is going through a PBX machine, make sure the communication application's tone dial detection feature is disabled. You can also use the ATX command.
You place a call, but a connection can't be made	Make sure the settings are correct in your communications application.

Problem	Procedure
After making a call you can't hear a ring	Make sure the tone or pulse selection in your communications application is set correctly. You can also use the ATD command.
Communication is cut off unexpectedly	The computer will automatically cut off communication when connection with the carrier is not successful for a set time interval. Try lengthening this time interval.
A CONNECT display is quickly replaced by NO CARRIER	Check the error control setting in your communications application. You can also use the ATN command.
Character display becomes garbled during a communication	In data transmission, make sure the parity bit and stop bit settings correspond with those of the remote computer. Check the flow control and communication protocol.
You cannot receive an incoming call	Check the rings before auto answer setting in your communications application. You can also use the ATS0 command. If problems persist, contact your dealer.

## LAN

Problem	Procedure
Cannot access LAN	Check for a firm cable connection between the LAN jack and the LAN hub. If problems persist, consult your LAN administrator.

## Wireless LAN

If the following procedures do not restore LAN access, consult your LAN administrator. For more information on wireless communication, refer to Chapter 4, *Operating Basics*.

Problem	Procedure
Cannot access Wireless LAN	Make sure the computer's wireless communication switch is set to on. If problems persist, contact your LAN administrator.



*The Wireless LAN feature is not available on all models.*

## Fingerprint sensor

Problem	Procedure
Reading of the fingerprint was not successful	<p>Please try again using the correct posture. Refer to <a href="#">Using the fingerprint sensor</a> in Chapter 4, <a href="#">Operating Basics</a>.</p> <p>Try the recognition process again using another enrolled finger.</p>
The fingerprint cannot be read due to injuries to the finger	<p>Try the recognition process again using another enrolled finger.</p> <p>If fingerprints from all the enrolled fingers cannot be read, please logon by using the keyboard to input the password for the time being.</p> <p>If problems persist, contact your dealer.</p>
Fingerprint Pre-OS feature or Single Sign On feature cannot be enabled	<p>Please use TOSHIBA HW Setup to register the User Password if it was not registered.</p>
Fingerprint Pre-OS feature does not work	<p>Make sure you have enroll finger in windows account.</p> <p>Set the User Password by using TOSHIBA HW Setup and restart the system.</p> <p>Make sure place a checkmark in “Enable Pre-OS Fingerprint Authentication” on the TrueSuite Access Manager setting.</p>

## ExpressCard

Refer also to Chapter 8, [Optional Devices](#).

Problem	Procedure
ExpressCard error occurs	<p>Reset the ExpressCard to make sure it is firmly connected.</p> <p>Make sure the connection between the external device and the card is firm.</p> <p>Check the card’s documentation.</p> <p>If problems persist, contact your dealer.</p>

## TOSHIBA support

If you require any additional help using your computer or if you are having problems operating the computer, you may need to contact TOSHIBA for additional technical assistance.

### Before you call

Some problems you experience may be related to software or the operating system, it is important to investigate other sources of assistance first. Before contacting TOSHIBA, try the following:

- Review troubleshooting sections in the documentation for software and peripheral devices.
- If a problem occurs when you are running software applications, consult the software documentation for troubleshooting suggestions. Call the software company's technical support for assistance.
- Consult the dealer you purchased your computer and/or software from. They are your best sources for current information and support.

### Where to write

If you are still unable to solve the problem and suspect that it is hardware related, write to TOSHIBA at the nearest location listed on the below.

Outside of Europe	In Europe
<p><b>Australia</b> TOSHIBA Australia Pty. Ltd. Information Systems Division 84-92 Talavera Road North Ryde N.S.W. 2113 Sydney</p>	<p><b>Germany &amp; Austria</b> TOSHIBA Europe (I.E.) GmbH Geschäftsbereich, Deutschland-Österreich Hammfelddamm8, D-41460 Neuss, Germany</p>
<p><b>Canada</b> TOSHIBA of Canada Ltd. 191 McNabb Street, Markham, Ontario L3R 8H2</p>	<p><b>France</b> TOSHIBA Systèmes France S.A. 7, Rue Ampère B.P. 131, 92804 Puteaux Cedex</p>
<p><b>China</b> TOSHIBA Personal Computer &amp; Network (Shanghai) Co. Ltd. 43F, Hongkong new world tower, No. 300 Huai Hai Zhong Road, Shanghai, P.R. China 200021</p>	<p><b>Netherlands</b> TOSHIBA Information Systems, Benelux B.V. Rivium Boulevard 41 2909 LK Capelle a/d IJssel</p>



---

<b>Outside of Europe</b>	<b>In Europe</b>
<b>Singapore</b> TOSHIBA Singapore Pte. Ltd. 438B Alexandra Road #06-01 Alexandra Technopark Singapore 119968	<b>Spain</b> TOSHIBA Information Systems, ESPAÑA Parque Empresarial San Fernando Edificio Europa, la Planta, Escalera A 28830 Madrid
<b>United States of America</b> TOSHIBA America Information Systems, Inc. 9740 Irvine Boulevard Irvine, California 92618 USA	<b>United Kingdom</b> TOSHIBA Information Systems (U.K.) Ltd. TOSHIBA Court Weybridge Business Park Addlestone Road Weybridge, Surrey KT15 2UL
<b>India</b> TOSHIBA India Pvt Ltd. PC Division 6th Floor, DR Gopal Das Bhawan Barakhamba Road, Delhi- 110001,India	<b>The Rest of Europe</b> TOSHIBA Europe (I.E.) GmbH Geschäftsbereich, Deutschland-Österreich Hammfelddamm 8, D-41460 Neuss, Germany

---



# Appendix A

## Specifications

This appendix summarizes the computer's technical specifications.

### Environmental Requirements

	Operating	Non-operating
<b>Ambient temperature</b>	5°C to 35°C	-20°C to 60°C
<b>Relative humidity</b>	20% to 80%	10% to 90%
<b>Altitude (from sea level)</b>	0 to 3,000 meters	-60 to 10,000 meters

### Power Requirements

<b>AC adaptor</b>	100-240 volts AC 50 or 60 hertz (cycles per second)
<b>Computer</b>	19 VDC

### Built-in Modem

<b>Network control unit (NCU)</b>	
<b>Type of NCU</b>	AA
<b>Type of line</b>	Telephone line (analog only)
<b>Type of dialling</b>	Pulse Tone
<b>Control command</b>	AT commands EIA-578 commands
<b>Monitor function</b>	Computer's speaker

---

**Communication specifications**

---

<b>Communication System</b>	Data:	Full duplex
	Fax:	Half duplex
<b>Communication protocol</b>	Data	
	ITU-T-Rec (Former CCITT)	V.21/V.22/V.22bis/V.32/ V.32bis/V.34/V.90/V.92
	Bell	103/212A
	Fax:	
	ITU-T-Rec (Former CCITT)	V.17/V.29/V.27ter/V.21 ch2
<b>Communication Speed</b>	Data transmission and reception	
		300/1200/2400/4800/7200/9600/12000/14400/ 16800/19200/21600/24000/26400/28800/31200/ 33600 bps
	Data reception only with V.90	
		28000/29333/30666/32000/33333/34666/36000/ 37333/38666/40000/41333/42666/44000/45333/ 46666/48000/49333/50666/52000/53333/54666/ 56000 bps
	Fax	
		2400/4800/7200/9600/12000/14400 bps
<b>Transmitting level</b>		-10 dBm
<b>Receiving level</b>		-10 to -40 dBm
<b>Input/output impedance</b>		600 ohms ±30%
<b>Error correcting</b>		MNP class 4 and ITU-T V.42
<b>Data compression</b>		MNP class 5 and ITU-T V.42bis
<b>Power supply</b>		+3.3V (supplied by computer)

---

# Appendix B

## Display Controller and Modes

### Display controller

The display controller interprets software commands into hardware commands that turn particular pels on or off.

The controller is an advanced Video Graphics Array (VGA) that provides Super VGA (SVGA) and Extended Graphics Array (XGA) support for the internal LCD and external monitors.

A high-resolution external monitor connected to the computer can display up to 2048 horizontal and 1536 vertical pixels at up to 16M colors.

The display controller also controls the video mode, which uses industry standard rules to govern the screen resolution and the maximum number of colors that can be displayed on screen.

Software written for a given video mode will run on any computer that supports the mode.

The computer's display controller supports all SVGA and XGA modes, the most widely used industry standards.

## Video Modes

The computer supports video modes defined in the table below. If your application offers a selection of mode numbers that do not match the numbers on the table, select a mode based on, resolution, number of colors and refresh rates.

**Table 1: Video Modes**

CRT Display Resolution	Color Depth (bpp)	Refresh Rate (Hz)
800*600	16bpp	60, 75, 85, 100
	32bpp	60, 75, 85, 100
1024*768	16bpp	60, 75, 85, 100
	32bpp	60, 75, 85, 100
1280*800 <sup>1</sup>	16bpp	60
	32bpp	60
1280*1024	16bpp	60, 75, 85, 100
	32bpp	60, 75, 85, 100
1600*1200	16bpp	60, 75, 85, 100
	32bpp	60, 75, 85, 100
1920*1440	16bpp	60, 75
	32bpp	60, 75
2048*1536	16bpp	60
	32bpp	60

1. Only for Intel/LCD panel

\* Only External Monitor can perform change of Refresh Rate (Hz).



- *Some of display mode might not be supported depending on the external monitor which you use.*
- *If you are running some applications (for example a 3D application or video playback and so on), you may see some disturbance, flickering or frame drop-ping on your screen. If that occurs, adjust the resolution of display, lowering it until the screen is displayed properly. You could also disable Windows Aero™. to help correct this situation.*

# Appendix C

## Wireless LAN

### Card Specifications

<b>Form Factor</b>	Mini PCI TypeIII
<b>Compatibility</b>	<ul style="list-style-type: none"><li>■ IEEE 802.11 Standard for Wireless LANs</li><li>■ Wi-Fi (Wireless Fidelity) certified by the Wi-Fi Alliance. The "Wi-Fi CERTIFIED" logo is a certification mark of the Wi-Fi Alliance.</li></ul>
<b>Network Operating System</b>	<ul style="list-style-type: none"><li>■ Microsoft® Windows® Networking</li></ul>
<b>Media Access Protocol</b>	<ul style="list-style-type: none"><li>■ CSMA/CA (Collision Avoidance) with Acknowledgement (ACK)</li></ul>
<b>Data Rate</b>	<ul style="list-style-type: none"><li>■ 54/48/36/24/18/12/9/6 Mb/s (IEEE 802.11a/g)</li><li>■ 11/5.5/2/1 Mb/s (IEEE 802.11 b)</li></ul>



*The Wireless LAN feature is not available on all models.*

## Radio Characteristics

Radio Characteristics of Wireless LAN Cards may vary according to:

- Country/region where the product was purchased
- Type of product

Wireless communication is often subject to local radio regulations. Although Wireless LAN wireless networking products have been designed for operation in the license-free 2.4GHz and 5GHz band, local radio regulations may impose a number of limitations to the use of wireless communication equipment.



*Refer to the sheet "Information to the User" for regulatory information that may apply in your country/region.*

---

<b>R-F Frequency</b>	■ Band 2.4GHz (2400~2497 MHz ) for 802.11b/g/n(draft version)
	■ Band 5GHz (5150~5850 MHz ) for 802.11a/n (draft version)
<b>Modulation Technique</b>	■ DSSS-CCK, DSSS-DQPSK, DSSS-DBPSK (IEEE 802.11b)
	■ OFDM-BPSK, OFDM-QPSK, OFDM-16QAM/OFDM-16QAM ( IEEE 802.11a/g)

---

The range of the wireless signal is related to the transmit rate of the wireless communication device. Communications at a lower transmission rate may travel larger distances.

- The range of your wireless devices can be affected when the antennas are placed near metal surfaces and solid high-density materials.
- Range is also impacted due to “obstacles” in the path of the transmission that may either absorb or reflect the radio signal.



## Supported Frequency Sub-bands

Subject to the radio regulations that apply in the countries/regions, your Wireless LAN card may support a different set of 2.4 GHz channels. Consult your Authorized Wireless LAN or TOSHIBA Sales office for information about the radio regulations that apply in the countries/regions.

### Wireless IEEE 802.11 Channels Sets (Revision B, G and draft N)

Frequency Range Channel ID	2400-2483.5 MHz
1	2412
2	2417
3	2422
4	2427
5	2432
6	2437
7	2442
8	2447
9	2452
10	<b>2457</b>
11	2462
12	<b>2467*<sup>1</sup></b>
13	<b>2472*<sup>1</sup></b>

\*1 Refer to the sheet Approved Countries/Regions for use for the countries/regions that in which these channels can be used.

When installing Wireless LAN cards, the channel configuration is managed as follows:

- For wireless clients that operate in a Wireless LAN Infrastructure, the Wireless LAN card will automatically start operation at the channel identified by the Wireless LAN Access Point. When roaming between different access points the station can dynamically switch to another channel if required.
- In a Wireless LAN Access Point, the Wireless LAN card will use the factory-set default channel (printed in bold), unless the LAN Administrator selected a different channel when configuring the Wireless LAN Access Point device.



## Appendix D

### AC Power Cord and Connectors

The power cord's AC input plug must be compatible with the various international AC power outlets and the cord must meet the standards for the country/region in which it is used. All cords must meet the following specifications:

<b>Length:</b>	Minimum 1.7 meters
<b>Wire size:</b>	Minimum 0.75 mm <sup>2</sup>
<b>Current rating:</b>	Minimum 2.5 amperes
<b>Voltage rating:</b>	125 or 250 VAC (depending on country/region's power standards)

### Certification agencies

<b>U.S. and Canada:</b>	UL listed and CSA certified No. 18 AWG, Type SVT or SPT-2 two conductor		
<b>Australia:</b>	AS		
<b>Japan:</b>	DENANHO		

#### *Europe:*

<b>Austria:</b>	OVE	<b>Italy:</b>	IMQ
<b>Belgium:</b>	CEBEC	<b>The Netherlands:</b>	KEMA
<b>Denmark:</b>	DEMKO	<b>Norway:</b>	NEMKO
<b>Finland:</b>	SETI	<b>Sweden:</b>	SEMKO
<b>France:</b>	UTE	<b>Switzerland:</b>	SEV
<b>Germany:</b>	VDE	<b>United Kingdom:</b>	BSI

In Europe, power cords must be VDE type, H05VVH2-F and two conductor. For the United States and Canada, plug configuration must be a 2-15P (250 V) or 1-15P (125 V) as designated in the U.S. National Electrical code handbook and the Canadian Electrical Code Part II.

The following illustrations show the plug shapes for the U.S.A. and Canada, the United Kingdom, Australia and Europe.

**USA and Canada**

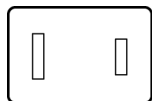

UL approved  
CSA approved

**United Kingdom**

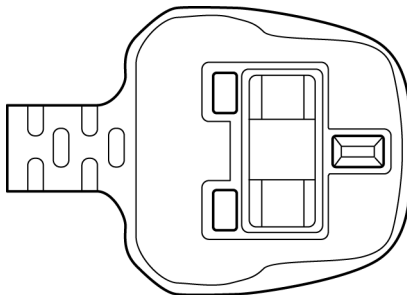

BS approved

**Australia**

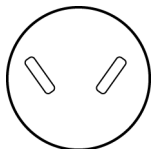

AS approved

**Europe**



Approved by the  
appropriate agency

# Appendix E

## Legal Footnotes

This chapter states the Legal Footnotes information applicable to TOSHIBA computers. In the text in this manual, \*XX is used to show which Legal Footnotes description is related to TOSHIBA computers.

Description(s) related to this computer are marked with a blue \*XX in this manual. Clicking on \*XX will display the related description.

### Non-applicable Icons

Certain computer chassis are designed to accommodate all possible configurations for an entire product series. Therefore, please be aware that your selected model may not have all the features and specifications corresponding to all of the icons or switches shown on the computer chassis.

### CPU

Central Processing Unit ("CPU") Performance Legal Footnotes.

CPU performance in your computer product may vary from specifications under the following conditions:

- use of certain external peripheral products
- use of battery power instead of AC power
- use of certain multimedia, computer generated graphics or video applications
- use of standard telephone lines or low speed network connections
- use of complex modeling software, such as high end computer aided design applications
- use of several applications or functionalities simultaneously
- use of computer in areas with low air pressure (high altitude >1,000 meters or >3,280 feet above sea level)

- use of computer at temperatures outside the range of 5°C to 30°C (41°F to 86°F) or >25°C (77°F) at high altitude (all temperature references are approximate and may vary depending on the specific computer model - please refer to your computer documentation or visit the TOSHIBA website at [www.pcsupport.toshiba.com](http://www.pcsupport.toshiba.com) for details).

CPU performance may also vary from specifications due to design configuration.

Under some conditions, your computer product may automatically shutdown. This is a normal protective feature designed to reduce the risk of lost data or damage to the product when used outside recommended conditions. To avoid risk of lost data, always make back-up copies of data by periodically storing it on an external storage medium. For optimum performance, use your computer product only under recommended conditions. Read additional restrictions in your product documentation. Contact TOSHIBA technical service and support, refer to *TOSHIBA support* section in Chapter 9 *Troubleshooting* for more information.

64-Bit Computing.

64-bit processors are designed to take advantage of 32 and 64 bit computing.

64-bit computing requires that the following hardware and software requirements are met:

- 64-bit Operating System
- 64-bit CPU, Chipset and BIOS (Basic Input/Output System)
- 64-bit Device drivers
- 64-bit applications

Certain device drivers and/or applications may not be compatible with a 64-bit CPU and therefore may not function properly. A 32-bit version of the operating system is preinstalled on your computer unless explicitly stated that the operating system is 64-bit.

## Memory (Main System)

Part of the main system memory may be used by the graphics system for graphics performance and therefore reduce the amount of main system memory available for other computing activities. The amount of main system memory allocated to support graphics may vary depending on the graphics system, applications utilized, system memory size and other factors. For computer's configured with 4 GB of system memory, the full system memory space for computing activities will be considerably less and will vary by model and system configuration.

## Battery Life

Battery life may vary considerably depending on product model, configuration, applications, power management settings and features utilized, as well as the natural performance variations produced by the design of individual components. Published battery life numbers are achieved on select models and configurations tested by TOSHIBA at the time of publication. Recharge time varies depending on usage. Battery may not charge while computer is consuming full power.

After going through many charge and discharge cycles, the battery will lose its ability to perform at maximum capacity and will need to be replaced.

This is a normal phenomenon for all batteries. To purchase a new battery pack, see the accessories information that is shipped with your computer.

## Hard Disk Drive (HDD) Capacity

1 Gigabyte (GB) means  $10^9 = 1,000,000,000$  bytes using powers of 10. The computer operating system, however, reports storage capacity using powers of 2 for the definition of  $1 \text{ GB} = 2^{30} = 1,073,741,824$  bytes, and therefore shows less storage capacity. Available storage capacity will also be less if the product includes one or more pre-installed operating systems, such as Microsoft Windows and/or pre-installed software applications, or media content. Actual formatted capacity may vary.

## LCD

Over a period of time, and depending on the usage of the computer, the brightness of the LCD screen will deteriorate. This is an intrinsic characteristic of LCD technology.

Maximum brightness is only available when operating in AC power mode. The screen will dim when the computer is operated on battery power and you may not be able to increase the brightness of the screen.

## Graphics Processor Unit ("GPU")

Graphics processor unit ("GPU") performance may vary depending on product model, design configuration, applications, power management settings and features utilized. GPU performance is only optimized when operating in AC power mode and may decrease considerably when operating in battery power mode.

## **Wireless LAN**

The transmission speed over the wireless LAN and the distance over which wireless LAN can reach may vary depending on surrounding electromagnetic environment, obstacles, access point design and configuration, and client design and software/hardware configurations.

[54Mbps is the theoretical maximum speed under the IEEE802.11 (a/b/g) standard.] The actual transmission speed will be lower than the theoretical maximum speed.

## **Copy Protection**

Applicable copy protection standards included in certain media may prevent or limit recording or viewing of the media.

## **Images**

All images are simulated for purposes of illustration.



## Glossary

The terms in this glossary cover topics related to this manual. Alternate naming is included for reference.

### **Abbreviations**

**AACS:** advanced access content system

**AC:** Alternating current

**ACPI:** Advanced Configuration and Power Interface

**AMT:** Intel Active Management Technology

**ASCII:** American Standard Code for Information Interchange

**BIOS:** basic input/output system

**bps:** bits per second

**CD:** compact disc

**CD-ROM:** Compact Disc Read-Only Memory

**CD-RW:** Compact Disc-ReWritable

**CMOS:** complementary metal-oxide semiconductor

**CPU:** central processing unit

**CRT:** cathode ray tube

**DC:** direct current

**DDC:** display data channel

**DDR:** double data rate

**DIMM:** dual inline memory module

**DVD:** digital versatile disc

**DVD-R:** Digital Versatile Disc-Recordable

**DVD-RAM:** Digital Versatile Disc-Random Access Memory

**DVD-R (Dual Layer):** Digital Versatile Disc Recordable Dual Layer

**DVD-ROM:** Digital Versatile Disc-Read Only Memory

**DVD-RW:** Digital Versatile Disc-ReWritable

**DVD+R (Double Layer):** Digital Versatile Disc Recordable Double Layer

**FDD:** floppy diskette drive

**FIR:** fast infrared

**GB:** gigabyte

**HDD:** hard disk drive  
**HD DVD:** High Definition DVD  
**HDCP:** high-bandwidth digital content protection  
**HDMI:** high definition multimedia interface  
**HDMI-CEC:** high definition multimedia interface consumer electronics control  
**IDE:** integrated drive electronics  
**IEEE:** Institute of Electrical and Electronics Engineers  
**IMSM:** Intel Matrix Storage Manager  
**I/O:** input/output  
**IRQ:** interrupt request  
**KB:** kilobyte  
**LAN:** local area network  
**LCD:** liquid crystal display  
**LED:** light emitting diode  
**MB:** megabyte  
**MMC:** multi media card  
**OCR:** optical character recognition (reader)  
**PC:** personal computer  
**PCI:** peripheral component interconnect  
**RAM:** random access memory  
**RGB:** red, green, and blue  
**ROM:** read only memory  
**RTC:** real time clock  
**S/P DIF:** Sony/Philips Digital Interface Format  
**SDRAM:** synchronous dynamic random access memory  
**SLI:** Scalable Link Interface  
**SO-DIMM:** small-outline dual in line memory module  
**SSD:** Solid state drive  
**TFT:** thin-film transistor  
**USB:** Universal Serial Bus  
**UXGA:** ultra extended graphics array  
**VGA:** video graphics array  
**WAN:** wide area network  
**WSXGA:** wide super extended graphics array  
**WSXGA+:** wide super extended graphics array plus  
**WUXGA:** Wide Ultra Extended Graphics Array  
**WXGA:** wide extended graphics array  
**WXGA+:** wide extended graphics array plus  
**XGA:** extended graphics array

## A

**AACS:** A standard for copy protection that is used for HD DVD. It manages copy and output.

**adaptor:** A device that provides a compatible connection between two units. For example, the computer's internal display adapter receives information from the software and translates it into images on the screen. An adapter can take a number of forms, from a microprocessor to a simple connector: An intelligent adapter (one that is capable of doing some processing) may also be called a controller.

**alphanumeric:** Keyboard characters including letters, numbers and other symbols, such as punctuation marks or mathematical symbols.

**alternating current (AC):** Electric current that reverses its direction of flow at regular intervals.

**analog signal:** A signal whose characteristics such as amplitude and frequency vary in proportion to (are an analog of) the value to be transmitted. Voice communications are analog signals.

**application:** A group of programs that together are used for a specific task such as accounting, financial planning, spreadsheets, word processing and games.

**ASCII:** American Standard Code for Information Interchange. ASCII code is a set of 256 binary codes that represent the most commonly used letters, numbers, and symbols.

## B

**backup:** A copy of a file, usually on a removable disk, kept in case the original file is lost or damaged.

**binary:** The base two number system composed of zeros and ones (off or on), used by most digital computers. The right-most digit of a binary number has a value of 1, the next a value of 2, then 4, 8, 16, and so on. For example, the binary number 101 has a value of 5. See also ASCII.

**BIOS:** Basic Input/Output System. The firmware that controls data flow within the computer. See also firmware.

**bit:** Derived from "binary digit," the basic unit of information used by the computer. It is either zero or one. Eight bits is one byte. See also byte.

**Bluetooth:** A short-range radio technology designed to simplify wireless communication among computers, communication devices and the Internet.

**board:** A circuit board. An internal card containing electronic components, called chips, which perform a specific function or increase the capabilities of the system.

**boot:** Short for bootstrap. A program that starts or restarts the computer. The program reads instructions from a storage device into the computer's memory.

**boot disk:** See system disk.

**bootable disk:** See system disk.

**bps:** Bits per second. Typically used to describe the data transmission speed of a modem.

**buffer:** The portion of the computer's memory where data is temporarily stored. Buffers often compensate for differences in the rate of flow from one device to another.

**bus:** An interface for transmission of signals, data or electric power.

**byte:** The representation of a single character. A sequence of eight bits treated as a single unit; also the smallest addressable unit within the system.

## C

**cache memory:** A section of very fast memory in which frequently used information is duplicated for quick access. Accessing data from cache is faster than accessing it from the computer's main memory. See also L1 cache, L2 cache.

**capacity:** The amount of data that can be stored on a magnetic storage device such as a floppy diskette or hard disk drive. It is usually described in terms of kilobytes (KB), where one KB = 1024 bytes, megabytes (MB), where one MB = 1024 KB and gigabytes (GB), where one GB = 1024 MB.

**CardBus:** An industry standard bus for 32-bit PC Cards.

**CD:** An individual compact disc. See also CD-ROM.

**CD-R:** A Compact Disc-Recordable disc can be written once and read many times. See also CD-ROM.

**CD-ROM:** A Compact Disc Read-Only Memory is a high capacity disc that can be read from but not written to. The CD-ROM drive uses a laser, rather than magnetic heads, to read data from the disc.

**CD-RW:** A Compact Disc-ReWritable disc can be rewritten many times. See also CD-ROM.

**character:** Any letter, number, punctuation mark, or symbol used by the computer. Also synonymous with byte.

**chassis:** The frame containing the computer.

**chip:** A small semiconductor containing computer logic and circuitry for processing, memory, input/output functions and controlling other chips.

**click:** To press and release the pointing device's primary button without moving the pointing device. In the Windows? operating system, this refers to the pointing device's left button, unless otherwise stated. See also double-click.

- CMOS:** Complementary Metal-Oxide Semiconductor. An electronic circuit fabricated on a silicon wafer that requires very little power. Integrated circuits implemented in CMOS technology can be tightly packaged and are highly reliable.
- cold start:** Starting a computer that is currently off (turning on the power).
- COM1, COM2, COM3 and COM4:** The names assigned to the serial and communication ports.
- commands:** Instructions you enter at the terminal keyboard that direct the actions of the computer or its peripheral devices.
- compatibility:** 1) The ability of one computer to accept and process data in the same manner as another computer without modifying the data or the media upon which it is being transferred. 2) the ability of one device to connect to or communicate with another system or component.
- components:** Elements or parts (of a system) which make up the whole (system).
- computer program:** A set of instructions written for a computer that enable it to achieve a desired result.
- computer system:** A combination of hardware, software, firmware, and peripheral components assembled to process data into useful information.
- configuration:** The specific components in your system (such as the terminal, printer, and disk drives) and the settings that define how your system works. You use the HW Setup program to control your system configuration.
- controller:** Built-in hardware and software that controls the functions of a specific internal or peripheral device (e.g. keyboard controller).
- CPU:** Central Processing Unit. The portion of the computer that interprets and executes instructions.
- CRT:** Cathode Ray Tube. A vacuum tube in which beams projected on a fluorescent screen-producing luminous spots. An example is the television set.
- cursor:** A small, blinking rectangle or line that indicates the current position on the display screen.

## D

- data:** Information that is factual, measurable or statistical that a computer can process, store, or retrieve.
- data bits:** A data communications parameter controlling the number of bits (binary digits) used to make up a byte. If data bits = 7 the computer can generate 128 unique characters. If data bits = 8 the computer can generate 256 unique characters.
- DC:** Direct Current. Electric current that flows in one direction. This type of power is usually supplied by batteries.

- default:** The parameter value automatically selected by the system when you or the program do not provide instructions. Also called a preset value.
- delete:** To remove data from a disk or other data storage device. Synonymous with erase.
- device driver:** A program (called a "driver") that permits a computer to communicate with a device.
- dialog box:** A window that accepts user input to make system settings or record other information.
- disable:** To turn a computer option off. See also enable.
- disk drive:** The device that randomly accesses information on a disk and copies it to the computer's memory. It also writes data from memory to the disk. To accomplish these tasks, the unit physically rotates the disk at high speed past a read-write head.
- disk storage:** Storing data on magnetic disk. Data is arranged on concentric tracks much like a phonograph record.
- display:** A CRT, LCD, or other image producing device used to view computer output.
- documentation:** The set of manuals and/or other instructions written for the users of a computer system or application. Computer system documentation typically includes procedural and tutorial information as well as system functions.
- double click:** To press and release the pointing device's primary button rapidly twice without moving the pointing device. In the Windows? operating system, this refers to the pointing device's left button, unless otherwise stated.
- driver:** A software program, generally part of the operating system, that controls a specific piece of hardware (frequently a peripheral device such as a printer or mouse).
- DVD:** An individual digital versatile (or video) disc. See also DVD-ROM.
- DVD-R (+R, -R):** A Digital Versatile Disc-Recordable disk can be written once and read many times. The DVD-R drive uses a laser to read data from the disc.
- DVD-RAM:** A Digital Versatile Disc-Random Access Memory is a high capacity, high performance disc that lets you store large volumes of data. The DVD-ROM drive uses a laser to read data from the disc.
- DVD-ROM:** A Digital Versatile Disc-Read Only Memory is a high capacity, high performance disc suitable for play back of video and other high-density files. The DVD-ROM drive uses a laser to read data from the disc.
- DVD-RW (+RW, -RW):** A Digital Versatile Disc-ReWritable disc can be rewritten many times.

## E

**echo:** To send back a reflection of the transmitted data to the sending device. You can display the information on the screen, or output it to the printer, or both. When a computer receives back data it transmitted to a CRT (or other peripheral device) and then transmits the data to printer, the printer is said to echo the CRT.

**enable:** To turn on a computer option. See also disable.

**erase:** See delete.

**escape:** 1) A code (ASCII code 27), signaling the computer that what follows are commands; used with peripheral devices such as printers and modems.

2) A means of aborting the task currently in progress.

**escape guard time:** A time before and after an escape code is sent to the modem which distinguishes between escapes that are part of the transmitted data, and escapes that are intended as a command to the modem.

**execute:** To interpret and execute an instruction.

## F

**fast infrared:** An industry standard that enables cableless infrared serial data transfer at speeds of up to 4 Mbps.

**file:** A collection of related information; a file can contain data, programs, or both.

**fingerprint sensor:** The fingerprint sensor compares and analyzes the unique characteristics in a fingerprint.

**firmware:** A set of instructions built into the hardware which controls and directs a microprocessor's activities.

**flash memory:** Non-volatile memory that can be written to as well as read. Information in flash memory remains whether or not the computer is receiving power. This type of memory is used to retain your fingerprint data. See also memory. Compare RAM and ROM.

**floppy diskette:** A removable disk that stores magnetically encoded data.

**floppy diskette drive (FDD):** An electromechanical device that reads and writes to floppy diskettes.

**folder:** An icon in Windows used to store documents or other folders.

**format:** The process of readying a blank disk for its first use. Formatting establishes the structure of the disk that the operating system expects before it writes files or programs onto the disk.

**function keys:** The keys labeled F1 through F12 that tell the computer to perform certain functions.

## G

**gigabyte (GB):** A unit of data storage equal to 1024 megabytes. See also megabyte.

**graphics:** Drawings, pictures, or other images, such as charts or graphs, to present information.

## H

**hard disk:** A storage device composed of a rigid platter or platters that can be magnetically coded with data. Hard disks hold much more information than diskettes and are used for long-term storage of programs and data. The primary (or only) hard disk in a computer is usually fixed, but some computers have secondary hard disks that are removable. By default, the hard disk is referred to as drive C.

**hard disk drive (HDD):** An electromechanical device that reads and writes a hard disk. See also hard disk.

**hardware:** The physical electronic and mechanical components of a computer system: typically, the computer itself, external disk drives, etc. See also software and firmware.

**hertz:** A unit of wave frequency that equals one cycle per second.

**host computer:** The computer that controls, regulates, and transmits information to a device or another computer.

**hot key:** The computer's feature in which certain keys in combination with the extended function key, FN, can be used to set system parameters, such as speaker volume.

**HW Setup:** A TOSHIBA utility that lets you set the parameters for various hardware components.

## I

**icon:** A small graphic image displayed on the screen or in the indicator panel. In Windows<sup>®</sup>, an icon represents an object that the user can manipulate.

**i.LINK (IEEE1394):** This port enables high-speed data transfer directly from external devices such as digital video cameras.

**input:** The data or instructions you provide to a computer, communication device or other peripheral device from the keyboard or external or internal storage devices. The data sent (or output) by the sending computer is input for the receiving computer.

**instruction:** Statements or commands that specify how to perform a particular task.



**interface:** 1) Hardware and/or software components of a system used specifically to connect one system or device to another.  
2) To physically connect one system or device to another to exchange information.  
3) The point of contact between user, the computer, and the program, for example, the keyboard or a menu.

**interrupt request:** A signal that gives a component access to the processor.

**I/O:** Input/output. Refers to acceptance and transfer of data to and from a computer.

**I/O devices:** Equipment used to communicate with the computer and transfer data to and from it.

## K

**K:** Taken from the Greek word kilo, meaning 1000; often used as equivalent to 1024, or 2 raised to the 10th power. See also byte and kilobyte.

**keyboard:** An input device containing switches that are activated by manually pressing marked keys. Each keystroke activates a switch that transmits a specific code to the computer. For each key, the transmitted code is, in turn, representative of the (ASCII) character marked on the key.

**kilobyte (KB):** A unit of data storage equal to 1024 bytes. See also byte and megabyte.

## L

**L1 cache:** Level one cache. Memory cache built into the processor to help improve processing speed. See also cache memory, L2 cache.

**L2 cache:** Memory cache installed on the motherboard to help improve processing speed. It is slower than L1 cache and faster than main memory. See also cache memory, L1 cache.

**LAN:** A group of computers or other devices dispersed over a relatively limited area and connected by a communications link that enables any device to interact with any other on the network.

**Light Emitting Diode (LED):** A semiconductor device that emits light when a current is applied.

**Liquid Crystal Display (LCD):** Liquid crystal sealed between two sheets of glass coated with transparent conducting material. The viewing-side coating is etched into character forming segments with leads that extend to the edge of the glass. Applying a voltage between the glass sheets.

## M

**main board:** See motherboard.

**megabyte (MB):** A unit of data storage equal to 1024 kilobytes. See also kilobyte.

**megahertz:** A unit of wave frequency that equals 1 million cycles per second. See also hertz.

**memory:** Typically refers to the computer's main memory, where programs are run and data is temporarily stored and processed. Memory can be volatile and hold data temporarily, such as RAM, or it can be nonvolatile and hold data permanently, such as ROM. A computer's main memory is RAM. See RAM, ROM.

**menu:** A software interface that displays a list of options on the screen. Also called a screen.

**microprocessor:** A hardware component contained in a single integrated circuit that carries out instructions. Also called the central processing unit (CPU), one of the main parts of the computer.

**mode:** A method of operation, for example, the Boot Mode, Sleep Mode or the Hibernation Mode.

**modem:** Derived from modulator/demodulator, a device that converts (modulates) digital data for transmission over telephone lines and then converts modulated data (demodulates) to digital format where received.

**monitor:** A device that uses rows and columns of pixels to display alphanumeric characters or graphic images. See also CRT.

**motherboard:** A name sometimes used to refer to the main printed circuit board in processing equipment. It usually contains integrated circuits that perform the processor's basic functions and provides connectors for adding other boards that perform special functions.

## N

**network:** A collection of computers and associated devices that are connected by communications facilities. A network allows you to share data and peripheral devices, such as printers, with other users and to exchange electronic mail.

**non-system disk:** A disk for storing programs and data that cannot be used to start the computer. Compare system disk.

**nonvolatile memory:** Memory that is capable of permanently storing information. Turning the computer's power off does not alter data stored in nonvolatile memory.

**numeric keypad overlay:** A feature that allows you to use certain keys on the keyboard to perform numeric entry, or to control cursor and page movement.

## O

**OCR:** Optical Character Recognition (reader). A technique or device that uses laser or visible light to identify characters and input them into a storage device.

**online state:** A functional state of a peripheral device when it is ready to receive or transmit data.

**operating system:** A group of programs that controls the basic operation of a computer. Operating system functions include interpreting programs, creating data files, and controlling the transmission and receipt (input/output) of data to and from memory and peripheral device.

**output:** The results of a computer operation. Output commonly indicates data.

1) printed on paper, 2) displayed at a terminal, 3) sent through the serial port of internal modem, or 4) stored on some magnetic media.

## P

**parallel:** Processes that occur simultaneously. In communications, it means the transmission of more than one bit of information at a time. On your computer, the parallel port provides a parallel communications interface between the computer and an appropriate device. Compare serial. parity:

1) The symmetrical relationship between two parameter values (integers) both of which are either on or off; odd or even; 0 or 1.  
2) In serial communications, an error detection bit that is added to a group of data bits making the sum of the bits even or odd. Parity can be set to none, odd, or even.

**password:** A unique string of characters used to identify a specific user. The computer provides various levels of password protection such as user and supervisor.

**PC card:** A credit-card-sized expansion card designed to increase the capabilities of notebook computers. PC Cards provide functions such as modem, fax/modem, hard disk drive, network adapter, sound card, or SCSI adapter.

**PCI:** Peripheral Component Interconnect. An industry standard 32-bit bus.

**peripheral:** Any device, such as a printer or joystick, that is attached to the computer and controlled by the computer's CPU.

**pixel:** A picture element. The smallest dot that can be made on a display or printer. Also called a pel.

**plug and play:** A capability with Windows that enables the system to automatically recognize connections of external devices and make the necessary configurations in the computer.

**pointing device:** Any device, such as the TouchPad or a mouse, that enables you to move the cursor on the screen.

**port:** The electrical connection through which the computer sends and receives data to and from devices or other computers.

**Power Saver:** A TOSHIBA utility that lets you set the parameters for various power-saving functions.

**program:** A set of instructions a computer can execute that enables it to achieve a desired result. See also application.

**prompt:** A message the computer provides indicating it is ready for or requires information or an action from you.

## R

**Radio frequency interference (RFI) shield:** A metal shield enclosing the printed circuit boards of the printer or computer to prevent radio and TV interference. All computer equipment generates radio frequency signals. The FCC regulates the amount of signals a computing device can allow past its shielding. A Class A device is sufficient for office use. Class B provides a more stringent classification for home equipment use. TOSHIBA portable computers comply with Class B computing device regulations.

**Random Access Memory (RAM):** Volatile memory that can be written to as well as read. Volatile here means that information in RAM is lost when you turn off your computer. This type of memory is used for your computer's main memory. See also memory. Compare ROM.

**resolution:** A measure of the sharpness of the images that can be produced by a printer or displayed on a screen. For a printer, resolution is expressed in dots per inch (dpi). For a screen, it is expressed as the number of pixels available horizontally and vertically

**restart:** Resetting a computer without turning it off (also called "warm boot", "soft reset" or "reboot"). See also boot.

**RGB:** Red, green, and blue. A device that uses three input signals, each activating an electron gun for a primary additive color (red, green, and blue) or port for using such a device. See also CRT.

**RJ45:** A modular LAN jack.

**Read Only Memory (ROM):** Non-volatile memory that can be read but not written to. Non-volatile here means that information in ROM remains whether or not the computer is receiving power. This type of memory is used to store your computer's BIOS, which is essential instructions the computer reads when you start it up. See also BIOS, memory. Compare RAM.

## S

- S/P DIF:** A standard of digital interface for audio.
- SCSI:** Small Computer System Interface is an industry standard interface for connection of a variety of peripheral devices.
- SD/SDHC Card:** Secure Digital cards are flash memory widely used in a variety of digital devices such as digital cameras and Personal Digital Assistants.
- serial:** Processes that occur one at a time. In communications, it means the transmission of one bit at a time sequentially over a single channel. On your computer, the serial port provides a serial interface between the computer and an appropriate device. Compare parallel.
- SIO:** Serial Input/Output. The electronic methodology used in serial data transmission.
- soft key:** Key combinations that emulate keys on the IBM keyboard, change some configuration options, stop program execution, and access the numeric keypad overlay.
- software:** The set of programs, procedures and related documentation associated with a computer system. Specifically refers to computer programs that direct and control the computer system's activities. See also hardware.
- stop bit:** One or more bits of a byte that follow the transmitted character or group codes in asynchronous serial communications.
- system disk:** A diskette that contains the operating system files needed to start the computer. Any diskette can be formatted as a system disk. A system disk is also called a "bootable disk", "boot disk" or a "startup disk." Compare non-system disk.

## T

- terminal:** A typewriter-like keyboard and CRT display screen connected to the computer for data input/output.
- TFT display:** A liquid crystal display (LCD) made from an array of liquid crystal cells using active-matrix technology with thin film transistor (TFT) to drive each cell.
- Touch Pad:** A pointing device integrated into the TOSHIBA computer palm rest.

## U

- USB:** Universal Serial Bus. This serial interface lets you communicate with several devices connected in a chain to a single port on the computer.

## V

**VGA:** Video Graphics Array is an industry standard video adaptor that lets you run any popular software.

**volatile memory:** Random access memory (RAM) that stores information as long as power is supplied to the computer.

## W

**warm start:** Restarting or resetting a computer without turning it off.

**Wi-Fi®:** A registered trademark term of the Wi-Fi Alliance that stands for Wireless Fidelity, and is another term for the communication protocol to permit an Ethernet connection using wireless communication components.

**window:** A portion of the screen that can display its own application, document or dialog box. Often used to mean a Microsoft® Windows® window.

**Wireless LAN:** Local Area Network (LAN) through wireless communication.

**Wireless WAN:** Wide Area Network (WAN) through wireless communication.

**write protection:** A method for protecting a floppy diskette from accidental erasure.

## Index

### A

- AC adaptor, 1-4
  - additional, 1-18
  - connecting, 3-3
- ASCII characters, 5-7

### B

- Battery
  - charging, 6-8
  - extending battery life, 6-11
  - indicator, 6-1
  - location, 2-6
  - Monitoring capacity, 6-10
  - real time clock, 1-4, 6-5
  - safety precautions, 6-6
  - save mode, 1-13
  - types, 6-4
- Battery pack, 1-4
  - additional, 8-10
  - replacing, 6-12

### C

- Cleaning the computer, 4-38

### D

- Display, 1-9
  - automatic power off, 1-12
  - brightness decreases, 5-4
  - brightness increases, 5-4
  - controller, 1-9
  - opening, 3-4

### E

- Equipment checklist, 1-1
- Express card
  - inserting, 8-2
  - removing, 8-3
- Expresscard, 8-2

### F

- Floppy disk
  - using, 4-13
- Fn + Esc (sound mute), 5-3
- Fn + F1 (instant security), 5-3
- Fn + F2 (power save mode), 5-3
- Fn + F3 (Sleep Mode), 5-3
- Fn + F4 (hibernation), 5-3
- Fn + F5 (display selection), 5-3
- Fn + F6 (Display Brightness decreases), 5-4
- Fn + F7 (Display Brightness increases), 5-4
- Fn + F8 (Wireless setting), 5-4
- Fn + F9 (Touch Pad), 5-4
- Fn Sticky key, 5-5
- Function keys, 5-2

### G

- Graphics controller, 1-9

### H

- Hard disk drive, 1-5
  - automatic power off, 1-12
- Hibernation, 1-13, 5-3
- HW Setup, 1-15

**K**

- Keyboard, 1-9, 5-1
  - emulating keys on
    - enhanced, 5-2
  - F1 ... F12 function keys, 5-2
  - hot keys, 5-3
  - typewriter keys, 5-1
  - Windows? special keys, 5-5
- Keypad overlay, 1-12, 5-6
  - numeric mode, 5-6
  - temporarily using normal keyboard (overlay on), 5-7
  - turning on the overlays, 5-6

**L**

- LAN, 1-11, 4-37
  - cable types, 4-37
  - connecting, 4-37
  - disconnecting, 4-38

**M**

- Media care, 4-30
  - CD/DVD/HD DVD, 4-30
- Memory, 1-3
  - expansion, 1-18, 8-7
  - installing, 8-7
  - removing, 8-9
- Modem, 1-11, 4-31
  - connecting, 4-33
  - disconnecting, 4-33
  - properties menu, 4-32
  - region selection, 4-31
- Monitor, external, 1-9, 8-11

**P**

- Ports, 1-9
  - external monitor, 1-9
  - USB, 1-9

**Power**

- conditions, 6-1
  - hibernation mode, 3-8
  - indicator, 6-2
  - panel power on/off, 1-13, 6-14
  - shut Down mode (Boot mode), 3-6
  - Sleep Mode, 3-6
  - system Auto Off, 6-14
  - turning off, 3-6
  - turning on, 3-5
- Power-up modes, 6-14**
- 
- Problems**
- AC power, 9-5
  - analyzing, 9-2
  - Battery, 9-5
  - DVD Super Multi drive, 9-9
  - ExpressCard, 9-21
  - Hard disk drive, 9-8
  - Hardware and system checklist, 9-3
  - Keyboard, 9-7
  - LAN, 9-20
  - LCD panel, 9-8
  - Memory expansion, 9-18
  - Modem, 9-19
  - Monitor, 9-19
  - overheating power down, 9-4
  - Pointing device, 9-14
  - Power, 9-4
  - Real Time Clock, 9-7
  - Self test, 9-4
  - Sound system, 9-19
  - Support from TOSHIBA, 9-22
  - System start-up, 9-3
  - USB, 9-16
  - Wireless LAN, 9-20
- Processor, 1-3**



**R**

Restarting the computer, 3-9

**S**

Security lock

attaching, 8-15

Sleep Mode, 1-13

setting, 3-6

System automatic, 1-13

Soft keys

emulating keys on

enhanced

keyboard, 5-2

ScrLock, 5-3

Sound System, 1-10

Headphone(S/P DIF) jack,

1-10

microphone jack, 1-10

mute hot keys, 5-3

**T**

TOSHIBA ConfigFree, 1-17

Touch Pad, 1-9

location, 2-7

using, 4-1

**U**

USB, 1-9

**V**

Video modes, B-2

Video RAM, 1-4

**W**

Wireless communication switch,

4-36

indicator, 4-36

Wireless LAN, 1-11

using, 4-35

