

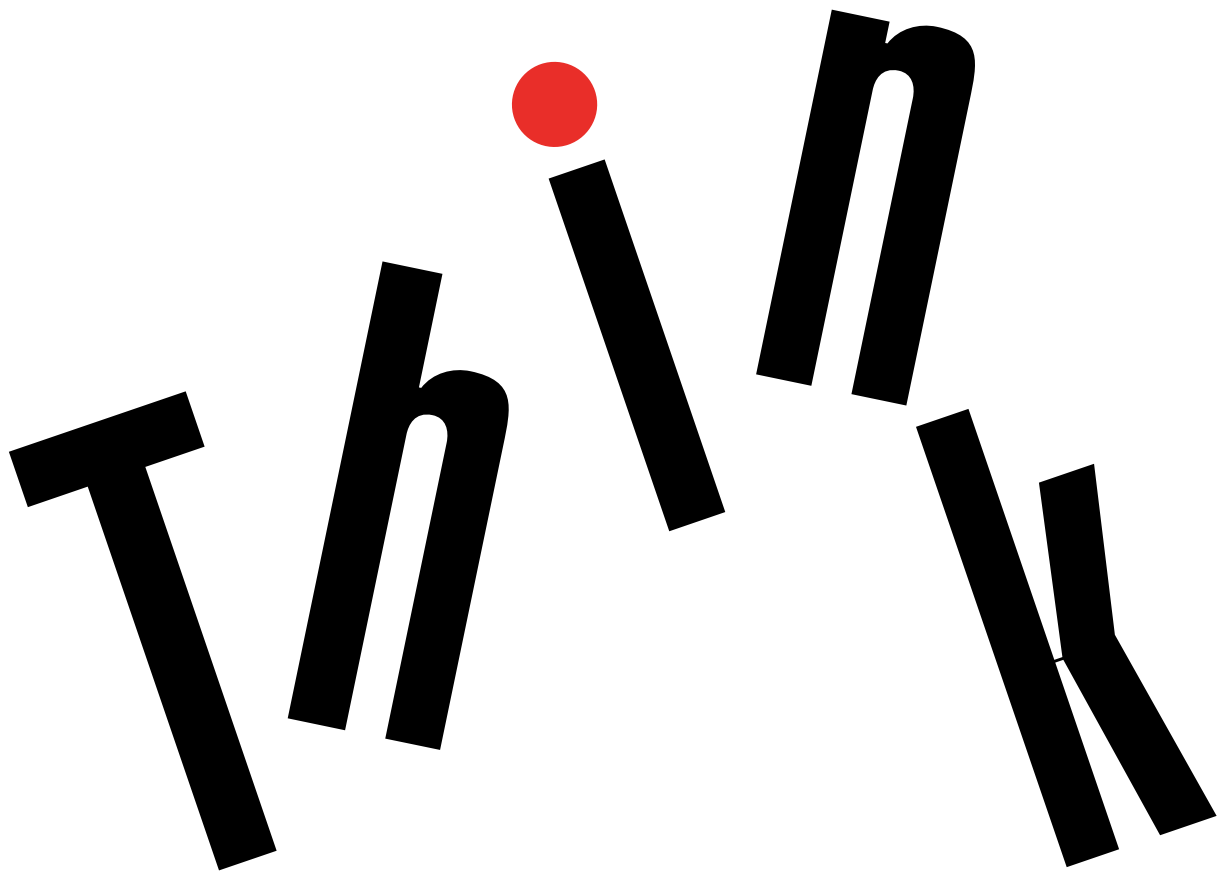

**ThinkPad**®

## ThinkPad X1 Tablet User Guide



# Welcome

Before using your tablet and this user guide, be sure to read the *Safety, Warranty, and Setup Guide* that comes with your tablet.

Lenovo® makes constant improvement on the documentation of your tablet. To get all the latest documents, go to:

<http://www.lenovo.com/UserManuals>

**Note:** Your tablet might look slightly different from illustrations in this user guide.

**First Edition (January 2016)**

**© Copyright Lenovo 2016.**

LIMITED AND RESTRICTED RIGHTS NOTICE: If data or software is delivered pursuant a General Services Administration "GSA" contract, use, reproduction, or disclosure is subject to restrictions set forth in Contract No. GS-35F-05925.

# Contents

<b>Read this first – important safety and handling information</b> . . . . .	<b>iii</b>
--	------------

<b>Chapter 1. Meeting ThinkPad X1 Tablet</b> . . . . .	<b>1</b>
--	----------

In the box . . . . .	1
Controls and connectors. . . . .	3
System-status indicator . . . . .	4
Features and specifications. . . . .	5
Operating environment . . . . .	6

<b>Chapter 2. Getting Started</b> . . . . .	<b>7</b>
---	----------

Setting up your tablet . . . . .	7
Adjusting the operating modes by kickstand . . . . .	7
Using the multi-touch screen . . . . .	8
Connecting to a wireless network . . . . .	9
Connecting to a wired network . . . . .	10
Charging the tablet . . . . .	10
Power button and power settings . . . . .	11

<b>Chapter 3. Using your tablet</b> . . . . .	<b>13</b>
---	-----------

Registering your tablet . . . . .	13
Discovering Lenovo apps . . . . .	13
Using an external display . . . . .	14
Using Bluetooth devices . . . . .	14
Using NFC devices . . . . .	15
Using a microSD card . . . . .	16
Using the fingerprint reader. . . . .	17
Removing or replacing the Base Module . . . . .	18
Using passwords. . . . .	19
Accessing tablet settings . . . . .	20
Getting help about the Windows operating system. . . . .	20
Using your tablet more comfortably . . . . .	20
Traveling with your tablet. . . . .	20
Taking care of your tablet . . . . .	21

<b>Chapter 4. Accessories</b> . . . . .	<b>23</b>
---	-----------

ThinkPad X1 Tablet Productivity Module. . . . .	23
ThinkPad X1 Tablet Thin Keyboard . . . . .	25
ThinkPad Pen Pro and pen holders. . . . .	28
ThinkPad WiGig Dock . . . . .	30

<b>Chapter 5. Advanced configuration.</b> . . . . .	<b>35</b>
---	-----------

Installing device drivers . . . . .	35
ThinkPad Tablet Setup app. . . . .	35
Updating the UEFI BIOS . . . . .	35

System management . . . . .	36
-----------------------------	----

<b>Chapter 6. Accessibility</b> . . . . .	<b>37</b>
---	-----------

<b>Chapter 7. Troubleshooting</b> . . . . .	<b>39</b>
---	-----------

Frequently asked questions . . . . .	39
Error messages . . . . .	40
Lenovo Solution Center . . . . .	42
Windows recovery apps . . . . .	42
Resetting your tablet . . . . .	42
Using advanced startup options . . . . .	43
Recovering your operating system if the Windows 10 operating system fails to start. . . . .	43
Creating and using a recovery USB drive . . . . .	43
Lenovo factory recovery USB key . . . . .	44
Lenovo Support Web site . . . . .	44
Lenovo Customer Support Center . . . . .	45
Purchasing additional services . . . . .	46

<b>Appendix A. Regulatory information</b> . . . . .	<b>47</b>
---	-----------

Certification-related information . . . . .	47
Labels for the Windows operating systems . . . . .	47
Wireless-related information . . . . .	47
Wireless interoperability . . . . .	47
Locating the UltraConnect™ wireless antennas . . . . .	48
Wireless-radio compliance information . . . . .	48
Usage environment and your health . . . . .	49
Electronic emission notice . . . . .	50
Federal Communications Commission Declaration of Conformity . . . . .	50
Industry Canada Class B emission compliance statement. . . . .	50
European Union - Compliance to the Electromagnetic Compatibility Directive . . . . .	50
German Class B compliance statement . . . . .	51
Korea Class B compliance statement . . . . .	51
Japanese VCCI Class B statement . . . . .	52
Japan compliance statement for products which connect to the power mains with rated current less than or equal to 20 A per phase . . . . .	52
Japan notice for ac power cord . . . . .	52
Lenovo product service information for Taiwan . . . . .	52
WEEE and recycling information. . . . .	52
Important WEEE information . . . . .	52
Recycling information for China . . . . .	53
Recycling information for Japan . . . . .	53

Recycling information for Brazil . . . . .	54	Turkish RoHS . . . . .	56
Battery recycling information for Taiwan . . . . .	54	Ukraine RoHS . . . . .	57
Battery recycling information for the United States and Canada . . . . .	54	India RoHS . . . . .	57
Battery recycling information for the European Union . . . . .	54	Additional compliance information . . . . .	57
Recycling information for China . . . . .	55	Brazil audio notice . . . . .	57
Restriction of Hazardous Substances Directive (RoHS). . . . .	55	Eurasian compliance mark . . . . .	57
European Union RoHS. . . . .	55	ENERGY STAR model information . . . . .	57
China RoHS . . . . .	56	Export classification notice . . . . .	58
		<b>Appendix B. Trademarks . . . . .</b>	<b>59</b>

---

## Read this first – important safety and handling information



Before using your ThinkPad® X1 Tablet (referred to as the tablet in this document), read all the information in this section. Reading the safety and handling information first helps you avoid the risk of personal injury, property loss, or accidental damage to your tablet.

For additional tips to help you operate the tablet safely, go to:  
<http://www.lenovo.com/safety>

This information can help you safely use your tablet. Follow and retain all information included with your tablet. The information in this document does not alter the terms of your purchase agreement or the Lenovo Limited Warranty. For more information, see “Warranty Information” in the *Safety, Warranty, and Setup Guide* that comes with your tablet.

Customer safety is important. Our products are developed to be safe and effective. However, tablets are electronic devices. Power cords, power adapters, and other features can create potential safety risks that can result in physical injury or property damage, especially if misused. To reduce these risks, follow the instructions included with your product, observe all warnings on the product and in the operating instructions, and review the information included in this document carefully. By carefully following the information contained in this document and provided with your product, you can help protect yourself from hazards and create a safer tablet work environment.

**Note:** This information includes references to power adapters and batteries. In addition to tablets, some products (such as speakers and monitors) ship with external power adapters. If you have such a product, this information applies to your product.

### ***Conditions that require immediate action***

**Products can become damaged due to misuse or neglect. Some product damage is serious enough that the product should not be used again until it has been inspected and, if necessary, repaired by an authorized servicer.**

**As with any electronic device, pay close attention to the product when it is turned on. On very rare occasions, you might notice an odor or see a puff of smoke or sparks vent from your product. Or you might hear sounds like popping, cracking, or hissing. These conditions might merely mean that an internal electronic component has failed in a safe and controlled manner. Or, they might indicate a potential safety issue. However, do not take risks or attempt to diagnose the situation yourself. Contact the Customer Support Center for further guidance. For a list of Service and Support phone numbers, see the following Web site:**

<http://www.lenovo.com/support/phone>

**Frequently inspect your tablet and its components for damage or wear or signs of danger. If you have any question about the condition of a component, do not use the product. Contact the Customer Support Center or the product manufacturer for instructions on how to inspect the product and have it repaired, if necessary.**

**In the unlikely event that you notice any of the following conditions, or if you have any safety concerns with your product, stop using the product and unplug it from the power source and telecommunication lines until you can speak to the Customer Support Center for further guidance.**

- Power cords, plugs, power adapters, extension cords, surge protectors, or power supplies that are cracked, broken, or damaged.
- Signs of overheating, smoke, sparks, or fire.

- Damage to a battery (such as cracks, dents, or creases), discharge from a battery, or a buildup of foreign substances on the battery.
- A cracking, hissing, or popping sound, or strong odor that comes from the product.
- Signs that liquid has been spilled or an object has fallen onto the tablet product, the power cord, or power adapter.
- The product, power cord, or power adapter has been exposed to water.
- The product has been dropped or damaged in any way.
- The product does not operate normally when you follow the operating instructions.

**Note:** If you notice these conditions with a product (such as an extension cord) that is not manufactured for or by Lenovo, stop using that product until you can contact the product manufacturer for further instructions, or until you get a suitable replacement.

***Prevent your tablet and adapter from getting wet:***

Do not immerse your tablet in water or leave it in a location where it can get saturated with water or other liquids.

***Protect yourself from the heat generated by your tablet:***

When your tablet is turned on or the battery is charging, some parts might become hot. The temperature that they reach depends on the amount of system activity and the level of charge in the battery. Extended contact with your body, even through clothing, could cause discomfort or even a skin burn. Avoid keeping your hands, your lap, or any other part of your body in contact with a hot section of the tablet for any extended time.

***Protect yourself from the heat generated by the ac power adapter:***

When the ac power adapter is connected to an electrical outlet and your tablet, it generates heat. Extended contact with your body, even through clothing, may cause a skin burn. Do not place the ac power adapter in contact with any part of your body while it is in use. Never use it to warm your body.

***Protect the cables from being damaged:***

Applying strong force to cables may damage or break them. Route communication lines, or the cables of an ac power adapter, a mouse, a keyboard, a printer, or any other electronic device, so that they cannot be walked on, tripped over, pinched by your tablet or other objects, or in any way subjected to treatment that could interfere with the operation of your tablet.

***Prevent hearing damage:***

Your tablet has a combo audio connector that you can use for headphones (also called a headset) or earphones.



**CAUTION:**

**Excessive sound pressure from earphones and headphones can cause hearing loss. Adjustment of the equalizer to maximum increases the earphone and headphone output voltage and the sound pressure level. Therefore, to protect your hearing, adjust the equalizer to an appropriate level.**

Excessive use of headphones or earphones for a long period of time at high volume can be dangerous if the output of the headphone or earphone connectors do not comply with specifications of EN 50332-2. The headphone output connector of your tablet complies with EN 50332-2 Sub clause 7. This specification

limits the tablet's maximum wide band true RMS output voltage to 150 mV. To help protect against hearing loss, ensure that the headphones or earphones you use also comply with EN 50332-2 (Clause 7 limits) for a wide band characteristic voltage of 75 mV. Using headphones that do not comply with EN 50332-2 can be dangerous due to excessive sound pressure levels.

If your tablet came with headphones or earphones in the package, as a set, the combination of the headphones or earphones and the tablet already complies with the specifications of EN 50332-1. If different headphones or earphones are used, ensure that they comply with EN 50332-1 (Clause 6.5 Limitation Values). Using headphones that do not comply with EN 50332-1 can be dangerous due to excessive sound pressure levels.

***Carry your tablet carefully:***

Use a quality carrying case that provides adequate cushioning and protection. Do not pack your tablet in a tightly packed suitcase or bag. Before putting your tablet in a carrying case, make sure that the tablet is off or in sleep mode. Do not put a tablet in a carrying case while it is on.

***Handle your tablet with care:***

Do not drop, bend, puncture, insert foreign objects into, or place heavy objects on your tablet. Sensitive components inside might get damaged.

***Glass parts notice***

**CAUTION:**

**Some parts of your product may be made of glass. This glass could break if the product is dropped on a hard surface or receives a substantial impact. If glass breaks, do not touch or attempt to remove the glass. Stop using your product until the glass is replaced by trained service personnel.**

***Take care when using your tablet in a motor vehicle or on a bicycle:***

Always prioritize your safety and the safety of others. Follow the law. Local laws and regulations might govern how you can use mobile electronic devices, such as your tablet, while you drive a motor vehicle or ride a bicycle.

***Service and upgrades***

Do not attempt to service a product yourself unless instructed to do so by Lenovo Customer Support Center or your documentation. Only use a Service Provider who is approved to repair your particular product.

**Note:** Some tablet parts can be upgraded or replaced by the customer. Upgrades typically are referred to as options. Replacement parts approved for customer installation are referred to as Customer Replaceable Units, or CRUs. Lenovo provides documentation with instructions when it is appropriate for customers to install options or replace CRUs. You must closely follow all instructions when installing or replacing parts. The Off state of a power indicator does not necessarily mean that voltage levels inside a product are zero. Before you remove the covers from a product equipped with a power cord, always make sure that the power is turned off and that the product is unplugged from any power source. If you have any questions or concerns, contact Lenovo Customer Support Center.

Although there are no moving parts in your tablet after the power cord has been disconnected, the following warnings are required for your safety.

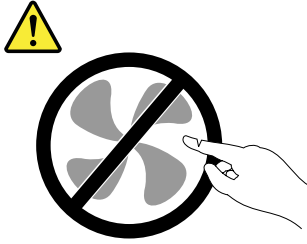

**CAUTION:**

**Hazardous moving parts. Keep fingers and other body parts away.**

***Power cords and power adapters***



**Use only the power cords and power adapters supplied by the product manufacturer.**

**The power cords shall be safety approved. For Germany, it shall be H05VV-F, 3G, 0.75 mm<sup>2</sup>, or better. For other countries, the suitable types shall be used accordingly.**

**Never wrap a power cord around a power adapter or other object. Doing so can stress the cord in ways that can cause the cord to fray, crack, or crimp. This can present a safety hazard.**

**Always route power cords so that they will not be walked on, tripped over, or pinched by objects.**

**Protect power cords and power adapters from liquids. For instance, do not leave your power cord or power adapter near sinks, tubs, toilets, or on floors that are cleaned with liquid cleansers. Liquids can cause a short circuit, particularly if the power cord or power adapter has been stressed by misuse. Liquids also can cause gradual corrosion of power cord terminals and/or the connector terminals on a power adapter, which can eventually result in overheating.**

**Always connect power cords and signal cables in the correct order and ensure that all power cord connectors are securely and completely plugged into receptacles.**

**Do not use any power adapter that shows corrosion at the ac input pins or shows signs of overheating (such as deformed plastic) at the ac input pins or anywhere on the power adapter.**

**Do not use any power cords where the electrical contacts on either end show signs of corrosion or overheating or where the power cord appears to have been damaged in any way.**

**To prevent possible overheating, do not cover the power adapter with clothing or other objects when the power adapter is plugged into an electrical outlet.**

***Extension cords and related devices***

Ensure that extension cords, surge protectors, uninterruptible power supplies, and power strips that you use are rated to handle the electrical requirements of the product. Never overload these devices. If power strips are used, the load should not exceed the power strip input rating. Consult an electrician for more information if you have questions about power loads, power requirements, and input ratings.



## *Plugs and outlets*



If a receptacle (power outlet) that you intend to use with your tablet equipment appears to be damaged or corroded, do not use the outlet until it is replaced by a qualified electrician.

Do not bend or modify the plug. If the plug is damaged, contact the manufacturer to obtain a replacement.

Do not share an electrical outlet with other home or commercial appliances that draw large amounts of electricity; otherwise, unstable voltage might damage your tablet, data, or attached devices.

Some products are equipped with a three-pronged plug. This plug fits only into a grounded electrical outlet. This is a safety feature. Do not defeat this safety feature by trying to insert it into a non-grounded outlet. If you cannot insert the plug into the outlet, contact an electrician for an approved outlet adapter or to replace the outlet with one that enables this safety feature. Never overload an electrical outlet. The overall system load should not exceed 80 percent of the branch circuit rating. Consult an electrician for more information if you have questions about power loads and branch circuit ratings.

Be sure that the power outlet you are using is properly wired, easily accessible, and located close to the equipment. Do not fully extend power cords in a way that will stress the cords.

Be sure that the power outlet provides the correct voltage and current for the product you are installing.

Carefully connect and disconnect the equipment from the electrical outlet.

## *Power supply statement*



Never remove the cover on a power supply or any part that has the following label attached.



Hazardous voltage, current, and energy levels are present inside any component that has this label attached. There are no serviceable parts inside these components. If you suspect a problem with one of these parts, contact a service technician.

## *External devices*

### **CAUTION:**

Do not connect or disconnect any external device cables other than Universal Serial Bus (USB) cables while the tablet power is on; otherwise, you might damage your tablet. To avoid possible damage to attached devices, wait at least five seconds after the tablet is shut down to disconnect external devices.

## Electrical current safety information



Electric current from power, telephone, and communication cables is hazardous.

To avoid a shock hazard:

- Do not use your tablet during a lightning storm.
- Do not connect or disconnect any cables or perform installation, maintenance, or reconfiguration of this product during an electrical storm.
- Connect all power cords to a properly wired and grounded electrical outlet.
- Connect to properly wired outlets any equipment that will be attached to this product.
- Whenever possible, use one hand only to connect or disconnect signal cables.
- Never turn on any equipment when there is evidence of fire, water, or structural damage.
- Do not use your tablet until all internal parts enclosures are fastened into place. Never use the tablet when internal parts and circuits are exposed.



Connect and disconnect cables as described in the following procedures when installing, moving, or opening covers on this product or attached devices.

To connect:

1. Turn everything OFF.
2. First, attach all cables to devices.
3. Attach signal cables to connectors.
4. Attach power cords to outlets.
5. Turn devices ON.

To disconnect:

1. Turn everything OFF.
2. First, remove power cords from outlets.
3. Remove signal cables from connectors.
4. Remove all cables from devices.

The power cord must be disconnected from the wall outlet or receptacle before installing all other electrical cables connected to the tablet.

The power cord may be reconnected to the wall outlet or receptacle only after all other electrical cables have been connected to the tablet.



During electrical storms, do not perform any replacement and do not connect the telephone cable to or disconnect it from the telephone outlet on the wall.

### **General battery notice**



**DANGER**

Batteries supplied by Lenovo for use with your product have been tested for compatibility and should only be replaced with approved parts. A battery other than the one specified by Lenovo, or a disassembled or modified battery is not covered by the warranty.

Battery abuse or mishandling can cause overheating, liquid leakage, or an explosion. To avoid possible injury, do the following:

- Do not open, disassemble, or service any battery.
- Do not crush or puncture the battery.
- Do not short-circuit the battery, or expose it to water or other liquids.
- Keep the battery away from children
- Keep the battery away from fire.

Stop using the battery if it is damaged, or if you notice any discharge or the buildup of foreign materials on the battery leads.

Store the rechargeable batteries or products containing the rechargeable batteries at room temperature, charged to approximately 30 to 50% of capacity. We recommend that the batteries be charged about once per year to prevent overdischarge.

Do not put the battery in trash that is disposed of in landfills. When disposing of the battery, comply with local ordinances or regulations.

### **Notice for built-in rechargeable battery**



**DANGER**

Do not attempt to replace the built-in rechargeable battery. Replacement of the battery must be done by a Lenovo-authorized repair facility or technician.

Only recharge the built-in rechargeable battery strictly according to instructions included in the product documentation.

The Lenovo-authorized repair facilities or technicians recycle Lenovo batteries according to local laws and regulations.

### **Notice for non-rechargeable coin-cell battery**



**DANGER**

Do not attempt to replace the non-rechargeable coin-cell battery. Replacement of the battery must be done by a Lenovo-authorized repair facility or technician.

The Lenovo-authorized repair facilities or technicians recycle Lenovo batteries according to local laws and regulations.

The following statement applies to users in the state of California, U.S.A.

**California Perchlorate Information:**

**Products containing manganese dioxide lithium coin-cell batteries may contain perchlorate.**

**Perchlorate Material - special handling may apply, See [www.dtsc.ca.gov/hazardouswaste/perchlorate](http://www.dtsc.ca.gov/hazardouswaste/perchlorate)**

***Use supported charging methods only:***

To recharge the internal battery of your tablet safely, see “Charging the tablet” on page 10.

**Attention:** Use only Lenovo-approved ac power adapters. Unauthorized ac power adapters could severely damage the tablet.

Charging devices might become warm during normal use. Ensure that you have adequate ventilation around the charging device. Unplug the charging device if any of the following occurs:

- The charging device has been exposed to rain, liquid, or excessive moisture.
- The charging device shows signs of physical damage.
- You want to clean the charging device.

Lenovo is not responsible for the performance or safety of products not manufactured or approved by Lenovo.

***Keep your tablet and accessories away from small children:***

Your tablet contains small parts that can be a choking hazard to small children. Additionally, the glass screen can break or crack if dropped on or thrown against a hard surface.

***Protect your data and software:***

Do not delete unknown files or change the name of files or directories that were not created by you; otherwise, your tablet software might fail to work.

Be aware that accessing network resources can leave your tablet vulnerable to viruses, hackers, spyware, and other malicious activities that might damage your tablet, software, or data. It is your responsibility to ensure that you have adequate protection in the form of firewalls, antivirus software, and anti-spyware software and keep this software up to date.

Keep electrical appliances such as an electric fan, radio, high-powered speakers, air conditioner, and microwave oven away from your tablet. The strong magnetic fields generated by these appliances can damage the screen and the data on the tablet.

***Plastic bag notice***



**Plastic bags can be dangerous. Keep plastic bags away from babies and children to avoid danger of suffocation.**

***Dispose according to local laws and regulations:***

When your tablet reaches the end of its useful life, do not crush, incinerate, immerse in water, or dispose of your tablet in any manner contrary to local laws and regulations. Some internal parts contain substances that can explode, leak, or have an adverse environmental affect if disposed of incorrectly.

See “WEEE and recycling information” on page 52 for additional information.



---

## Chapter 1. Meeting ThinkPad X1 Tablet

Get an overview of the tablet, such as the connectors, indicators, features, specifications, and operating environment.

**Note:** Your tablet might look slightly different from the illustrations in this chapter.

---

### In the box

Your shipping box contains the following items. Depending on the model, your tablet might come with one or more of the accessories. If your tablet does not come with some of the accessories, you can purchase them from a Lenovo reseller or from the Lenovo Web site at:

<http://www.lenovo.com/essentials>



ThinkPad X1 Tablet



Lenovo USB-C 45W AC Adapter



Documentation



ThinkPad Pen Pro \*



USB 3.0 pen holder \*



ThinkPad X1 Tablet Thin Keyboard Pen Holder \*



ThinkPad USB 3.0 Ethernet Adapter \*



Lenovo Mini-DisplayPort to HDMI Cable \*



Lenovo Mini-DisplayPort to VGA Adapter Cable \*



Lenovo USB C to HDMI plus Power Adapter \*



Lenovo USB C to VGA plus Power Adapter \*



ThinkPad WiGig Dock \*



ThinkPad X1 Tablet  
Productivity Module \*



ThinkPad X1 Tablet Thin  
Keyboard \*

\* Available on some models



## Controls and connectors

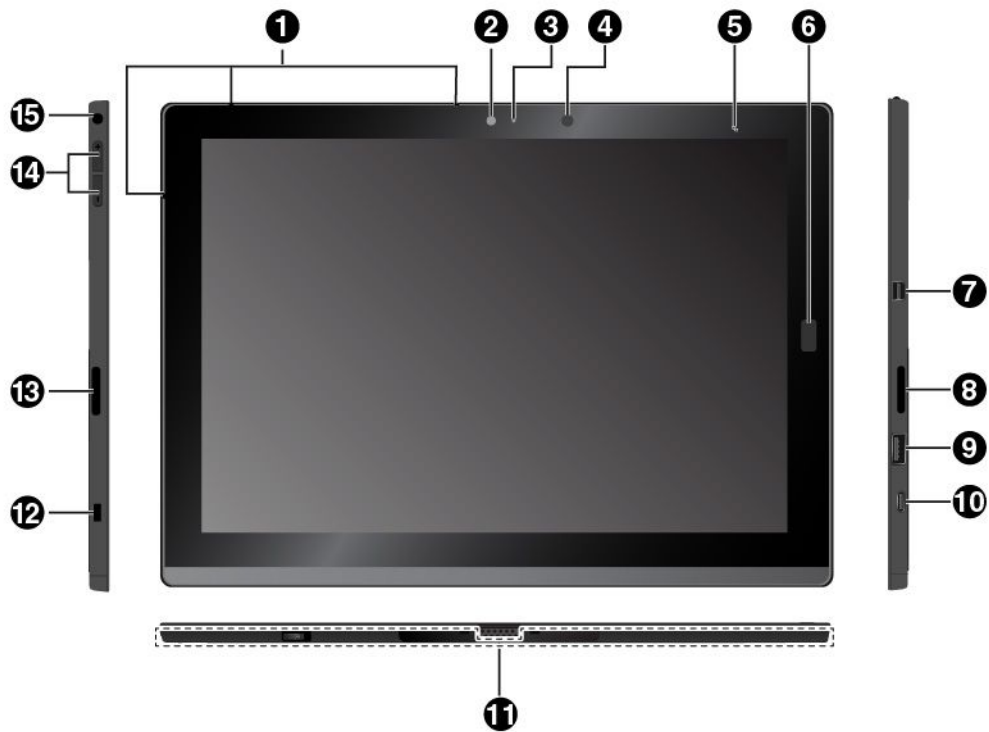

- ❶ Microphones
- ❷ Front camera
- ❸ Camera-status indicator
- ❹ Ambient light sensor
- ❺ NFC touchpoint \*
- ❻ Fingerprint reader \*
- ❼ Mini DisplayPort® connector
- ❽ Speaker
- ❾ USB 3.0 connector
- ❿ USB-C connector
- ⓫ Base Module
- ⓬ Security-lock slot
- ⓭ Speaker
- ⓮ Volume-control buttons
- ⓯ Audio connector

\* Available on some models

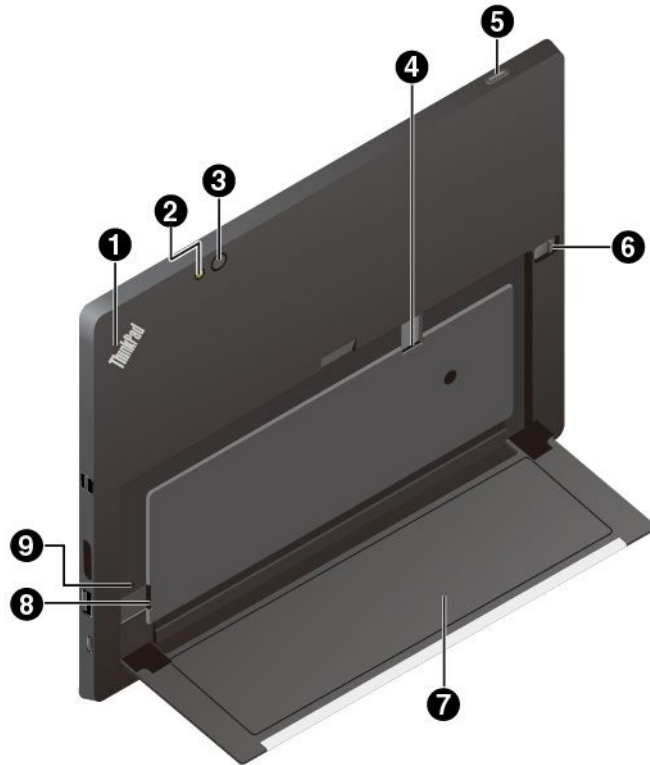

- ❶ System-status indicator
- ❸ Rear camera
- ❺ Power button
- ❽ Kickstand
- ❾ Emergency-reset hole

- ❷ Rear-camera flash light
- ❹ Nano-SIM-card slot \*
- ❻ Kickstand release knob
- ❿ microSD card slot

\* Available on some models

## System-status indicator

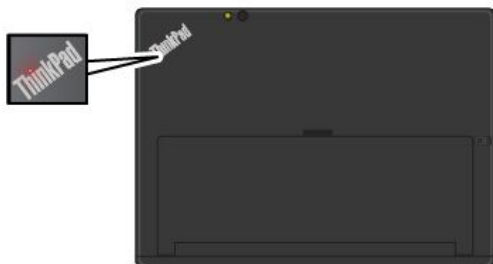

- **Blinks three times:** The tablet is initially connected to a power source.
- **On:** The tablet is on and in use.
- **Off:** The tablet is off or in sleep mode.

---

## Features and specifications

---

<b>Size</b>	<ul style="list-style-type: none"><li>• Width: 291.5 mm (11.5 inches)</li><li>• Depth: 209.5 mm (8.2 inches)</li><li>• Thickness<ul style="list-style-type: none"><li>– Without ThinkPad X1 Tablet Thin Keyboard: 8.75 mm (0.34 inch)</li><li>– With ThinkPad X1 Tablet Thin Keyboard: 13.9 mm (0.55 inch)</li></ul></li></ul>
<b>Microprocessor and memory</b>	<p>To view the microprocessor and memory information, open the Start menu  and tap <b>Settings</b> → <b>System</b> → <b>About</b>.</p> <p><b>Note:</b> <b>Settings</b> might not be displayed on the Start menu. In this case, tap <b>All apps</b> to find <b>Settings</b>.</p>
<b>Operating system</b>	Windows 10
<b>Storage</b>	M.2 solid-state drive
<b>Display</b>	<ul style="list-style-type: none"><li>• Size: 304.8 mm (12 inches)</li><li>• Screen resolution: 2160 x 1440 pixels</li><li>• Automatic brightness control (ambient light sensor)</li><li>• Anti-fingerprint, In-Plane Switching (IPS), and Full High Definition (FHD) technology</li><li>• Multi-touch technology</li></ul>
<b>Cameras</b>	<ul style="list-style-type: none"><li>• Front camera, 2 megapixels</li><li>• Rear camera, 8 megapixels with flash</li></ul>
<b>Connectors</b>	<ul style="list-style-type: none"><li>• Combo audio connector</li><li>• Mini DisplayPort connector</li><li>• USB 3.0 connector</li><li>• USB-C connector</li></ul>
<b>Slots</b>	<ul style="list-style-type: none"><li>• microSD card slot</li><li>• Nano Subscriber Identity Module (SIM) card slot *</li></ul>
<b>Security features</b>	<ul style="list-style-type: none"><li>• Fingerprint reader *</li><li>• Password</li><li>• Security-lock slot</li><li>• Trusted Platform Module (TPM) *</li></ul>
<b>Battery</b>	37 Wh Li-Polymer battery
<b>Wireless features</b>	<ul style="list-style-type: none"><li>• Bluetooth 4.1</li><li>• Global Positioning System (GPS) *</li><li>• Near field communication (NFC) *</li><li>• Wireless local area network (WLAN)</li><li>• Wireless wide area network (WWAN) *</li><li>• Wireless Gigabit Alliance (WiGig) *</li></ul>
<b>Power source (ac power adapter)</b>	<ul style="list-style-type: none"><li>• Sine-wave input at 50 Hz to 60 Hz</li><li>• Input rating of the ac power adapter: 100 V ac to 240 V ac</li></ul>

\* Available on some models

---

## Operating environment

---

**Maximum altitude without pressurization** 5000 m (16 404 ft)

---

**Temperature**

- At altitudes up to 2438 m (8000 ft)  
Operating: 5.0°C to 35.0°C (41°F to 95°F)  
Storage: 5.0°C to 43.0°C (41°F to 109°F)
  - At altitudes above 2438 m (8000 ft)  
Maximum temperature when operating under unpressurized conditions:  
31.3°C (88°F)
- 

**Relative humidity**

- Operating: 8% to 95%
- Storage: 5% to 95%

If possible, place your tablet in a dry, well-ventilated area without direct exposure to sunshine. Do not use or store your tablet in dusty, dirty areas, or extremely hot or cold areas.

---

---

## Chapter 2. Getting Started

Learn the basics to get started with your ThinkPad tablet. Follow the instructions to set up your tablet, use the multi-touch screen, connect to a network, and put your tablet into proper power modes.

---

### Setting up your tablet

When you use the tablet for the first time, do the following to complete the initial setup:

1. Connect your tablet to ac power.
2. Press the power button to turn on the tablet.
3. Follow the instructions on the screen to complete the initial setup.

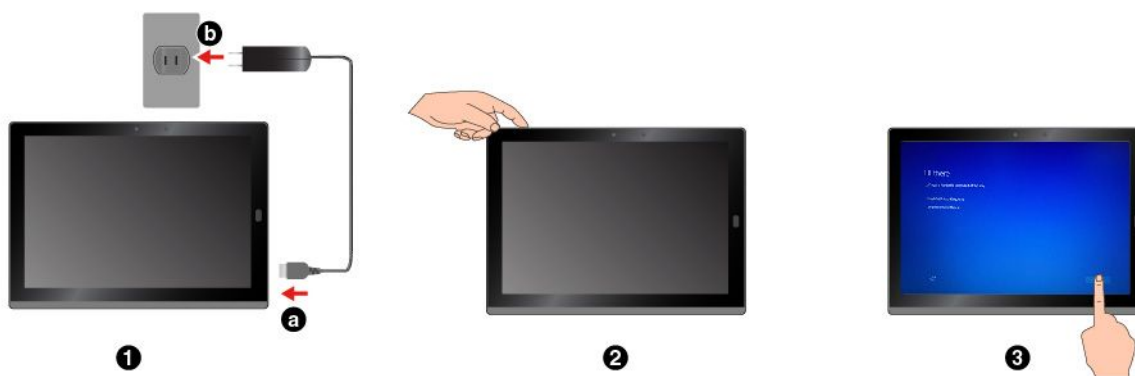

---

### Adjusting the operating modes by kickstand

Your tablet has a built-in kickstand. By flipping the kickstand open, you can use the tablet in either stand mode or stylus mode.



**Stand mode**



**Stylus mode**

The kickstand is multi-positional. In stand mode and stylus mode, you can adjust the kickstand to many angles for your most comfortable using experience. The following figures show the supported angles of the kickstand.



## Using the multi-touch screen

Use the touch gestures to interact with your tablet.

This section introduces only the most frequently used gestures. For a whole list of supported gestures, refer to the Windows help information. See “Getting help about the Windows operating system” on page 20.

**Note:** Some gestures are supported only on certain apps.

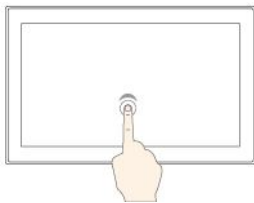

### Tap

Tap on the screen to open, select, or activate the item you tap.

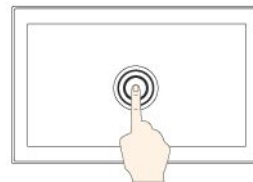

### Tap and hold

Tap and hold on the screen to open a menu with multiple options.

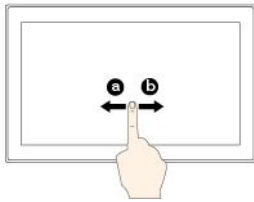

### Slide

Slide leftward or rightward on the screen to scroll through items, such as lists, pages, and photos.

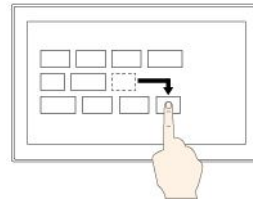

### Drag

Drag an item to the desired location to move an object.

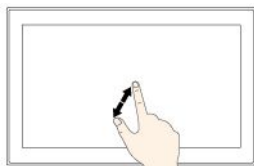

### Zoom in

Put two fingers on the screen and move them farther apart to zoom in.

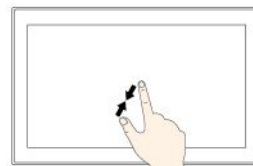

### Zoom out

Put two fingers on the screen and move them closer together to zoom out.

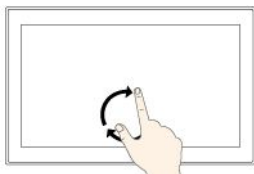

### Rotate

Put two or more fingers on an item, and then rotate your fingers clockwise or counterclockwise.

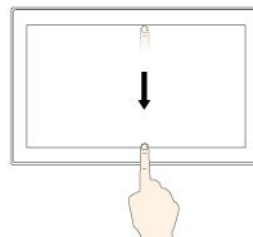

### Swipe in from the top edge to the bottom edge

Close the current full-screened app.

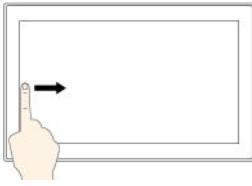

### Swipe in from the left edge

View all your open apps in task view.

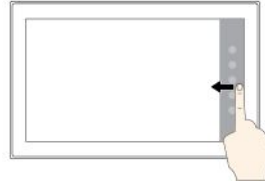

### Swipe in from the right edge

Open the action center.

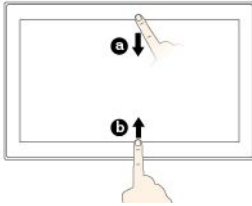

### Swipe in shortly from the top or bottom edge

- From the top: Show the hidden title bar in full-screened apps.
- From the bottom: Show the taskbar in full-screened apps.

### Tips on using the multi-touch screen

- The multi-touch screen is a glass panel covered with a plastic film. Do not apply pressure or place any metallic object on the screen that might damage the touch panel or cause it to malfunction.
- Do not use fingernails, gloved fingers, or inanimate objects other than an approved ThinkPad Pen Pro for input on the screen.

### Tips on cleaning the multi-touch screen

- Turn off the tablet before cleaning the multi-touch screen.
- Use a dry, soft, and lint-free cloth or a piece of absorbent cotton to remove fingerprints or dust from the multi-touch screen. Do not apply solvents to the cloth.
- Gently wipe the screen using a top-down motion. Do not apply any pressure on the screen.

---

## Connecting to a wireless network

Connect your tablet to the Internet or other wireless networks so that you can browse on your tablet and share information.

Your tablet supports the following wireless networks:

- **Wi-Fi network**

The Wi-Fi feature provides network access at distances of up to 100 meters (328 feet) depending on the Wi-Fi router and your surroundings. Your tablet is installed with a wireless-LAN card to support the Wi-Fi connection. The quality of the Wi-Fi signal is affected by the number of connected devices, the infrastructure, and the objects through which the signal is transmitted.

- **Mobile broadband network** (supported by some models)

The mobile broadband feature enables you to connect to the Internet from any location where cellular service is available. Mobile broadband connections use 3G, 4G, or LTE cellular and mobile networks, just as phones do. Mobile broadband connection is supported only on tablet models with a wireless-WAN card installed.

A nano-SIM card or an external mobile broadband device is required to connect to a mobile broadband network.

Your tablet also supports Bluetooth and NFC wireless communications. For more information, see “Using NFC devices” on page 15 and “Using Bluetooth devices” on page 14.

### To join a wireless network:

1. Tap the wireless-network icon in the Windows notification area. A list of available wireless networks is displayed.

**Note:** If the **Airplane mode** control is on, or the **Wi-Fi** control or **Mobile broadband** control is off, the list might not be displayed. Tap the corresponding control to display the list.

2. Tap a network to join it. For secured networks, enter the valid password when prompted.

### To replace or install a nano-SIM card:

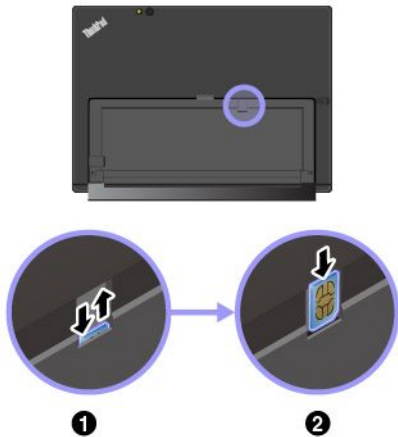

The nano-SIM card slot is behind the kickstand. Before you start, turn off the tablet.

1. Push the nano-SIM card inward a little until you hear a click. The nano-SIM card ejects. Gently slide the card out of the slot.

**Note:** If no nano-SIM card is installed in the slot, skip this step.

2. Install a new nano-SIM card into the slot with the metal contacts facing upward. Ensure that the new nano-SIM card is installed in correct orientation.

---

## Connecting to a wired network

You might need to use a wired network connection through an Ethernet cable when downloading large files. Depending on the model, your tablet might come with a ThinkPad USB 3.0 Ethernet Adapter. Use this adapter to connect your tablet to a wired network. You can also purchase it from: <http://www.lenovo.com/essentials>

### To connect to a wired network:

1. Connect the ThinkPad USB 3.0 Ethernet Adapter to the USB 3.0 connector on your tablet.
2. Connect an Ethernet cable into the ThinkPad USB 3.0 Ethernet Adapter.
3. Tap the wired network icon in the Windows notification area, and enter the user name and password if needed.

---

## Charging the tablet

Check the battery-status icon in the Windows notification area and charge the battery if the battery power remaining is low.



### **To charge the tablet:**

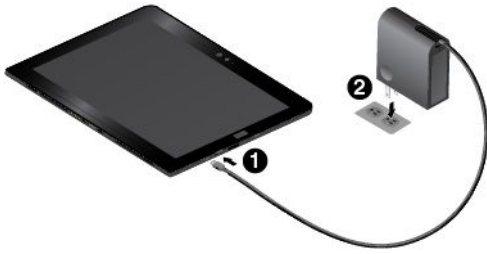

**Attention:** Use only Lenovo-approved ac power adapters. Unauthorized ac power adapters could severely damage the tablet.

1. Connect the Lenovo USB-C 45W AC Adapter to the USB-C connector of your tablet.
2. Connect the Lenovo USB-C 45W AC Adapter to a proper electric outlet.



---

## **Power button and power settings**

If you will not use the tablet for a period of time, put the tablet into sleep mode or turn off the tablet to save power. You also can adjust the power settings to achieve the best balance between performance and power saving.

### **Putting your tablet into sleep mode and waking up your tablet**

If you are not going to use the tablet for just a few minutes, put your tablet into sleep mode to lock it and save power.

To put your tablet into sleep mode, open the Start menu , then tap **Power**  → **Sleep**.

To wake up your tablet from sleep mode, press the power button.

### **Turning off and turning on your tablet**

If you are not going to use the tablet for long periods, turn off your tablet to save power.

To turn off your tablet, open the Start menu , then tap **Power**  → **Shut down**.

To turn on your tablet, press and hold the power button.

### **Adjusting the power settings**

To achieve the best balance between performance and power saving, adjust your power settings.

To adjust power settings, do the following:

1. Go to Control Panel. For information about accessing Control Panel, see “Accessing tablet settings” on page 20.
2. Tap **System and Security** → **Power Options**.
3. Follow the instructions on the screen.



---

## Chapter 3. Using your tablet

Learn the skills to make the best use of your tablet such as using Lenovo apps, connecting an NFC device, and using the fingerprint reader.

---

### Registering your tablet

Register your tablet with Lenovo, so that you can get the following benefits:

- Notification of a recall or other severe problem
- Quicker service when you call Lenovo for help
- Automatic notification of free software and special promotional offers
- Other extended privileges and services provided in some locations

**To register your tablet with Lenovo, do one of the following:**

- Use Lenovo Companion . For information about accessing Lenovo Companion, see “Discovering Lenovo apps” on page 13.
  - Go to <http://www.lenovo.com/register> and follow the instructions on the screen.
- 

### Discovering Lenovo apps

Lenovo provides the following apps to help you work more easily and securely.

**Note:** Preinstalled Lenovo apps are subject to change. To explore more Lenovo apps, go to: <http://www.lenovo.com/support>

**To access Lenovo apps:**

1. Open the Start menu , then tap **All apps**.
2. Tap a Lenovo app to open it.
3. If the app you want is not displayed, try searching for it in the search box.



#### **Lenovo Companion**

Your system’s best features should be easy to access and understand. With Lenovo Companion, they are. This app is filled with exclusive Lenovo content to help you learn about your new system.



#### **Lenovo Settings**

This app enhances your computing experience by enabling you to configure camera and microphone settings, optimize power settings, and create and manage multiple network profiles.



#### **Lenovo Solution Center**

This app enables you to troubleshoot and resolve tablet problems. It combines diagnostic tests, system information collection, security status, and support information, along with hints and tips.



#### **System Update**

This app enables you to keep the software up-to-date by downloading and installing software packages, including Lenovo apps, device drivers, and third-party apps.



### **WRITEit**

WRITEit gives you instant handwriting input wherever you need it. You can write directly in any app and text field, edit text in real time, see your full screen, and convert your handwriting into digital text.

---

## Using an external display

Connect your tablet to an external display to share a presentation or work with multiple applications.

### **Connecting to a wireless display**

To connect to a wireless display, do the following:

1. Open the Start menu .
2. Tap **Settings** → **Devices** → **Connected devices** → **Add a device**.

**Note:** **Settings** might not be displayed in the Start menu. In this case, tap **All apps** to find **Settings**.

3. Follow the instructions on the screen.

### **Connecting to a wired display**

Your tablet has a mini DisplayPort connector and a USB-C connector. You can connect the tablet to a VGA-compatible or HDMI-compatible external display through one of the following adapters:

- Lenovo Mini-DisplayPort to VGA Adapter Cable
- Lenovo Mini-DisplayPort to HDMI Cable
- Lenovo USB-C to VGA Adaptor
- Lenovo USB-C to HDMI Adaptor

If your tablet does not come with these adapters, you can purchase them from the Lenovo Web site at: <http://www.lenovo.com/essentials>

### **Choosing a display mode**

You can display your desktop and apps on the tablet, the external display, or both.

To choose how to display the video output, do the following:

1. Open the Start menu .
2. Tap **Settings** → **System** → **Display**.

**Note:** **Settings** might not be displayed in the Start menu. In this case, tap **All apps** to find **Settings**.

3. Follow the instructions on the screen to select a presentation scheme.

---

## Using Bluetooth devices

Bluetooth is a short-range wireless communications technology. Use Bluetooth to establish a wireless connection between your tablet and another Bluetooth-enabled device within a distance of about 10 m (32.8 ft).

### **To pair your tablet with a Bluetooth device:**

1. Turn on the Bluetooth device and make it discoverable. For more information, see the document that comes with the Bluetooth device.
2. Open the Start menu , then tap **Settings** → **Devices** → **Bluetooth**. Then tap the Bluetooth control to turn it on. A list of available Bluetooth devices is displayed.

**Note:** **Settings** might not be displayed in the Start menu. In this case, tap **All apps** to find **Settings**.

3. Select the target Bluetooth device and tap **Pair**.

---

## **Using NFC devices**

Depending on the model, your tablet might come with the NFC feature. NFC is a high-frequency and short-range wireless communications technology. By using the NFC feature, you can establish radio communications between your tablet and another NFC-enabled device over a distance no more than a few centimeters. Some Lenovo apps are using the NFC feature.

This section provides the basic instructions on pairing your tablet with an NFC device. For more information about data transfer, refer to the documentation of the NFC device.

### **Attention:**

- Before handling the NFC card, touch a metal table or a grounded metal object. Otherwise the card might get damaged by the static electricity from your body.
- During the data transfer, do not put your tablet or NFC-enabled smartphone into sleep mode; otherwise, your data could get damaged.

### **To pair your tablet with an NFC card:**

Before you start, ensure that the card is in NFC Data Exchange Format (NDEF), otherwise the card cannot be detected.

1. Tap the card on the NFC touchpoint as shown.
2. Slowly move the card in the upright direction within a 10 mm (0.39 inch) distance. Then hold the card for seconds until you are prompted that the card has been successfully detected.



### **To pair your tablet with an NFC-enabled smartphone:**

Before you start, ensure that the smartphone screen is facing upward.

1. Tap the smartphone on the NFC touchpoint as shown.
2. Slowly move the smartphone in the upright direction within a 10 mm (0.39 inches) distance. Then hold the smartphone for seconds until you are prompted that the smartphone has been successfully detected.



### **Enabling the NFC feature**

In case that the NFC feature of your tablet is disabled, do the following to enable the NFC feature:

1. Open the Start menu .
2. Tap **Settings** → **Network & Internet** → **Airplane mode**.

**Note:** **Settings** might not be displayed in the Start menu. In this case, tap **All apps** to find **Settings**.

3. Tap the **NFC** control to turn it on.

If you still cannot enable the NFC feature, check the **NFC** setting in the ThinkPad Tablet Setup app by doing the following:

1. Open the ThinkPad Tablet Setup app. See “ThinkPad Tablet Setup app” on page 35.
2. Tap **Security** → **I/O Port Access**.
3. Set the **NFC** option to **On**.

---

## **Using a microSD card**

Your tablet has a microSD card slot behind the kickstand. The microSD card slot supports the following types of cards:

- Secure Digital eXtended-Capacity (SDXC) card
- Secure Digital (SD) card
- Secure Digital High-Capacity (SDHC) card

This section provides the basic instructions on installing and removing the microSD card. For more information about data transfer, refer to the documentation of the microSD card.

### **Attention:**

- Before handling the microSD card, touch a metal table or a grounded metal object. Otherwise the card might get damaged by the static electricity from your body.
- During the data transfer, do not put your tablet into sleep mode; otherwise, your data could get damaged.

### To install a microSD card:

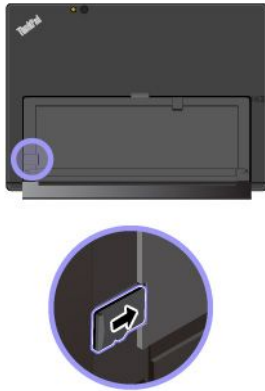

1. Flip the kickstand open to locate the microSD card slot.
2. Hold the card with the metal contacts facing downward and pointing toward the tablet. Insert the card into the microSD card slot until you hear a click.

### To remove the microSD card:

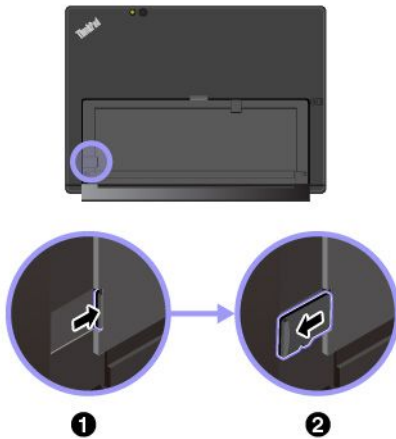

1. Flip the kickstand open to locate the microSD card slot.
2. Push the microSD card inward a little until you hear a click. The microSD card ejects.
3. Gently slide the card out of the card slot.

---

## Using the fingerprint reader

Depending on the model, your tablet might have a fingerprint reader. With fingerprint authentication, you can log in to your tablet by swiping your fingerprints instead of entering the password.

### Enrolling your fingerprints

To enable fingerprint authentication, enroll your fingerprints first by doing the following:

**Note:** It is recommended that you enroll more than one fingerprint in case of any injuries to your fingers.

1. Open the Start menu , then tap **Settings** → **Accounts** → **Sign-in options**.

**Note:** **Settings** might not be displayed in the Start menu. In this case, tap **All apps** to find **Settings**.

2. Follow the instructions on the screen to enroll your fingerprint.

When you scan your finger over the fingerprint reader, note the following:

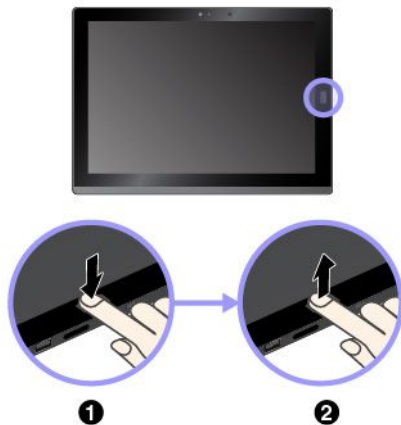

1. Tap the fingerprint reader with the top joint of your finger and hold your finger there for one or two seconds with a little pressure.
2. Lift your finger to complete one scan.

### ***Tips on using the fingerprint reader***

- The following actions could damage the fingerprint reader or cause it to malfunction:
  - Scratching the surface of the reader with a hard and pointed object
  - Scraping the surface of the reader with your fingernail or anything hard
  - Using or touching the reader with a dirty finger
- You might not be able to register or authenticate your fingerprints in the following situations:
  - Your finger is wrinkled.
  - Your finger is rough, dry, or injured.
  - Your finger is stained with dirt, mud, or oil.
  - Your finger is wet.
  - You used a finger that had not been enrolled.

To resolve the problem, try the following:

- Clean or wipe your hands to remove any excess dirt or moisture from the fingers.
- Enroll and use a different finger for authentication.
- If you notice any of the following conditions, gently clean the surface of the reader with a dry, soft, and lint-free cloth:
  - The surface of the reader is dirty or stained.
  - The surface of the reader is wet.
  - The reader often fails to enroll or authenticate your fingerprint.

---

## **Removing or replacing the Base Module**

The Base Module is attached to the tablet as a protective cover. If the Base Module is broken or lost, you can get a new one from Lenovo (fee might be charged). To contact Lenovo, see “Lenovo Customer Support Center” on page 45.

To remove the Base Module, slide the release knob to unlock the Base Module and then remove it as shown.



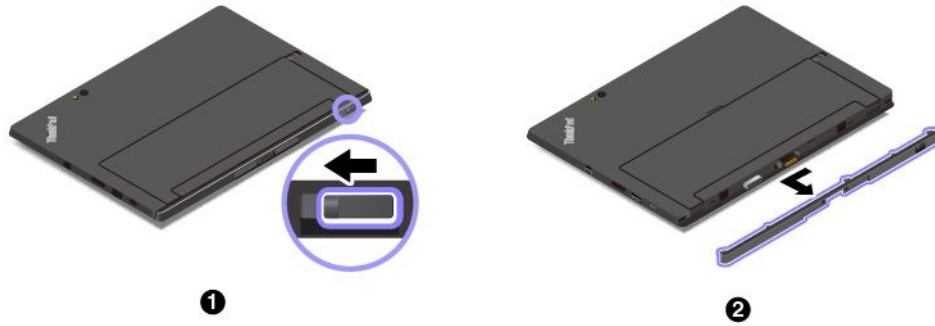

To install the Base Module, insert it into the guide holes and slide it as shown to lock it into position.



## Using passwords

You can set a supervisor password to prevent your tablet from unauthorized use.

Supervisor password protects the system information stored in ThinkPad Tablet Setup. Without the supervisor password, no one can change the configuration of the tablet.

The system administrator can set the same supervisor password on many tablets to make administration easier. It is recommended that you record your password and store it in a safe place. If you forget your supervisor password, Lenovo cannot reset your password. You must take your tablet to a Lenovo reseller or a Lenovo marketing representative to have the system board replaced. Proof of purchase is required, and a fee will be charged for parts and service.

### ***To set, change, or remove a password:***

**Note:** Before you start, print these instructions and the instructions on “ThinkPad Tablet Setup app” on page 35. You also can screen-capture the instructions and send the pictures to your smartphone or notebook computer so that you can view the instructions during operation.

1. Save all open files, and exit all apps.
2. Open the ThinkPad Tablet Setup app. See “ThinkPad Tablet Setup app” on page 35.
3. Tap **Security** → **Password**.
4. Tap **Enter** next to the supervisor password item and follow the instructions on the screen.
5. Save configuration changes and exit.

---

## Accessing tablet settings

Personalize your tablet by changing the system and device settings so that you can get the best use of your tablet.

### **To access quick settings:**

- Open the action center . The key settings are displayed at the bottom.

### **To access Control Panel:**

- Tap and hold on the taskbar, and then tap **Control Panel** from the pop-up menu.
- Open the Start menu , then tap **All apps → Windows System → Control Panel**.

---

## Getting help about the Windows operating system

Your tablet is preinstalled with the Windows operating system. To get help about this operating system, read the following instructions.

### **To get quick help:**

- Open the Start menu , then tap **Get started**.

### **To get comprehensive help content:**

- Search whatever you want to know in the Search box on the taskbar, or ask Cortana® personal assistant.

**Note:** Cortana is your personal assistant for Windows. Cortana is available in some countries or regions.

---

## Using your tablet more comfortably

With the help of all the conveniences and powerful features of your tablet, you can carry your tablet all day long at many places. Therefore it is important that you remain attentive to good posture, good lighting, and proper seating to achieve greater comfort with your tablet.

**Active sitting and rest breaks:** The longer you sit and work with your tablet, the more important it is to observe your working posture. Make minor voluntary postural changes and take frequent, short breaks when you use the tablet for a long time. Your tablet is a light and mobile system; remember that it can easily be repositioned to accommodate many posture modifications you might wish to make.

**Work area setup options:** Familiarize yourself with all of your office furniture so that you know how to adjust your work surface, seat, and other work tools to accommodate your preferences for comfort. If your work area is not in an office setting, be sure to take special note of employing active sitting and utilizing work breaks. There are many ThinkPad product solutions available to help you modify and expand your tablet to best suit your needs. Explore your options for docking solutions and external products that can provide the adjustability and features you want. To view some of these options, go to:  
<http://www.lenovo.com/essentials>

---

## Traveling with your tablet

The following tips help you travel more comfortably and securely with your tablet.

### **Tips on anti-theft and anti-damage**

- While it is safe to allow your tablet to go through the x ray machines at airport security stations, it is important to keep your eyes on the tablet at all times to prevent theft.

- Put your tablet in a protective case when not in use to prevent damage or scratching.

### ***Tips on airline traveling***

- If you want to use the wireless service, check with the airline for any restrictions before boarding the airplane.
- If there are restrictions on the use of tablets with wireless features on an airplane, enable the Airplane mode. So that all wireless connections are disabled. To enable the Airplane mode, do the following:
  1. Tap the wireless-network icon on the taskbar.
  2. Tap the **Airplane mode** control to disable all wireless connections.
- Be careful about the seat in front of you on the airplane. Place your tablet in a safe position so that it does not get caught when the person in front of you leans back.

---

## **Taking care of your tablet**

Handle your tablet with care so that you can enjoy this product for a long time.

### ***Cleaning your tablet***

To clean your tablet, unplug all cables and turn off the tablet by pressing and holding the power button for a few seconds. Then wipe the tablet screen with a soft, lint-free, and dry cloth to clear stains and smudges.

**Note:** Do not use screen cleaners, household cleaners, aerosol sprays, solvents, alcohol, ammonia, or abrasives to clean your tablet.

### ***Protecting the screen with a replaceable film***

You can purchase a replaceable film to protect the screen from scratching and extend the life of your tablet. To use a replaceable film, clean the screen first and then apply the replaceable film on the screen.

### ***Storing the tablet for extended periods***

If you are not going to use your tablet for an extended period of time, remove the nano-SIM card from your tablet. Pack your tablet with a protective case and store it in a well-ventilated and dry area without direct exposure to sunshine.



---

## Chapter 4. Accessories

The following accessories are designed to enhance your experience with the tablet:

- “ThinkPad X1 Tablet Productivity Module” on page 23
- “ThinkPad X1 Tablet Thin Keyboard” on page 25
- “ThinkPad Pen Pro and pen holders” on page 28
- “ThinkPad WiGig Dock” on page 30

Depending on the model, your tablet might not come with certain accessories. You can purchase the accessories from the Lenovo Web site at:  
<http://www.lenovo.com/essentials>

---

### ThinkPad X1 Tablet Productivity Module

Depending on the model, your tablet might come with a ThinkPad X1 Tablet Productivity Module (referred to as Productivity Module). Attach the Productivity Module to your tablet to expand working capability by adding additional connectors and battery life.

#### *Productivity Module overview*



#### **1 USB 3.0 connector**

The USB 3.0 connector is used for connecting USB-compatible devices, such as a USB keyboard, a USB mouse, or a USB storage device.

#### **2 Lock levers**

The lock levers lock the Productivity Module to your tablet tightly.

#### **3 HDMI connector**

High-Definition Multimedia Interface (HDMI) connector is a digital audio and video interface that can connect a compatible digital audio device or video monitor, such as a DVD player or an HDTV.

#### **4 OneLink+ connector**

Use the OneLink+ connector to connect to the ThinkPad OneLink+ Dock or the OneLink+ Ethernet Adapter. You can purchase these devices from Lenovo at <http://www.lenovo.com/essentials>.

#### *Attaching the Productivity Module to your tablet*

Before attaching the Productivity Module to your tablet, remove the Base Module first. See “Removing or replacing the Base Module” on page 18.

1. Lift the lock levers.
2. Insert the Productivity Module into the guide holes of your tablet.
3. Close the lock levers to lock the Productivity Module.

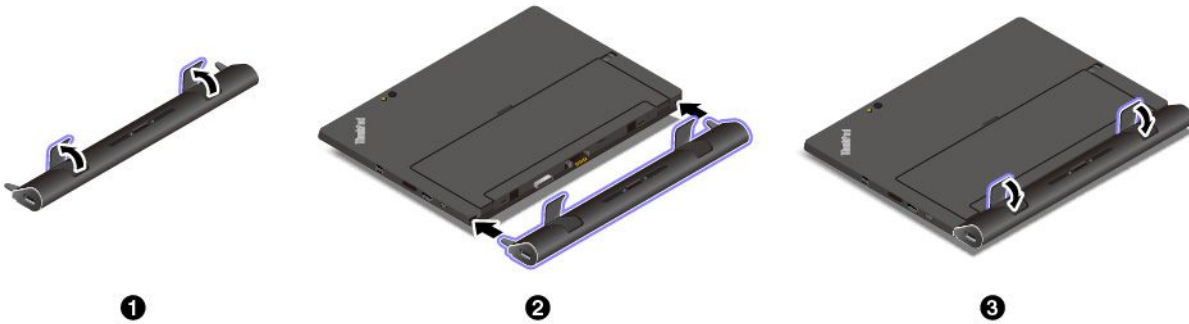

### ***Using the Productivity Module with your tablet***

You can use the Productivity Module with your tablet in the following three modes.



With the Productivity Module attached, you also can adjust the kickstand to many angles in stand mode and stylus mode. The following figures show the supported angles of the kickstand when the Productivity Module is attached to your tablet.



---

## ThinkPad X1 Tablet Thin Keyboard

Depending on the model, your tablet might come with a ThinkPad X1 Tablet Thin Keyboard (referred to as Thin Keyboard). Attach the keyboard to your tablet so that you can transform your tablet into a portable notebook computer.

**Note:** The color of the Thin Keyboard might vary by country or region of delivery.

### Thin Keyboard overview



#### ❶ Pogo cover with guide pins

The pogo cover with guide pins enables you to attach the keyboard to your tablet magnetically.

#### ❷ TrackPoint® device

The TrackPoint device enables you to perform all the functions of a traditional mouse, such as pointing, clicking, and scrolling.

#### ❸ Trackpad

The trackpad is a pointer-positioning device that enables you to point, select, and scroll, like you do with a traditional mouse. You also can use the trackpad to perform basic touch gestures.

#### ❹ Special keys

The special keys provide quick access to certain apps and functions such as adjusting the speaker volume.

### Attaching the Thin Keyboard to your tablet

- For tablets equipped with the Base Module:

The Thin Keyboard magnetically attaches to your tablet as shown by bringing the two close together. When the Thin Keyboard gets close enough, it aligns and snaps into place. You can easily remove the Thin Keyboard by pulling it away.



- For tablets equipped with the Productivity Module:

1. Remove the cover on the Productivity Module.
2. Bring the Thin Keyboard close to the Productivity Module. When the Thin Keyboard gets close enough, it aligns and snaps into place.



### ***Using the Thin Keyboard***

With the Thin Keyboard attached to your tablet, you can use the Thin Keyboard in the following modes.

#### **Lay-flat mode**

Keep the Thin Keyboard laid flat on the table surface as shown.

- a With the Productivity Module attached
- b With the Base Module attached

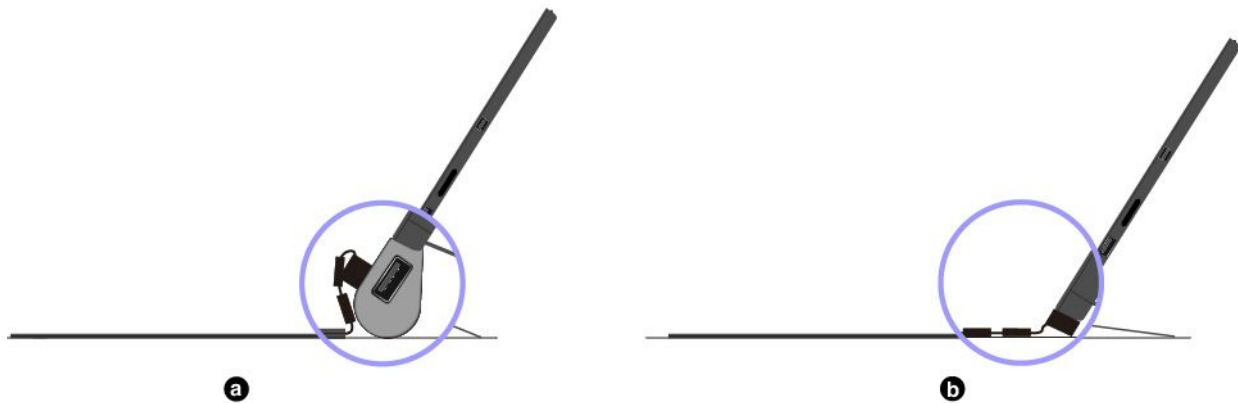



## Tilt mode

Fold the living hinge as shown. The magnetic bars on the living hinge attach to the tablet automatically. The angle between the Thin Keyboard and the table surface is about 6.5 degrees to 14.7 degrees.

- a** With the Productivity Module attached
- b** With the Base Module attached

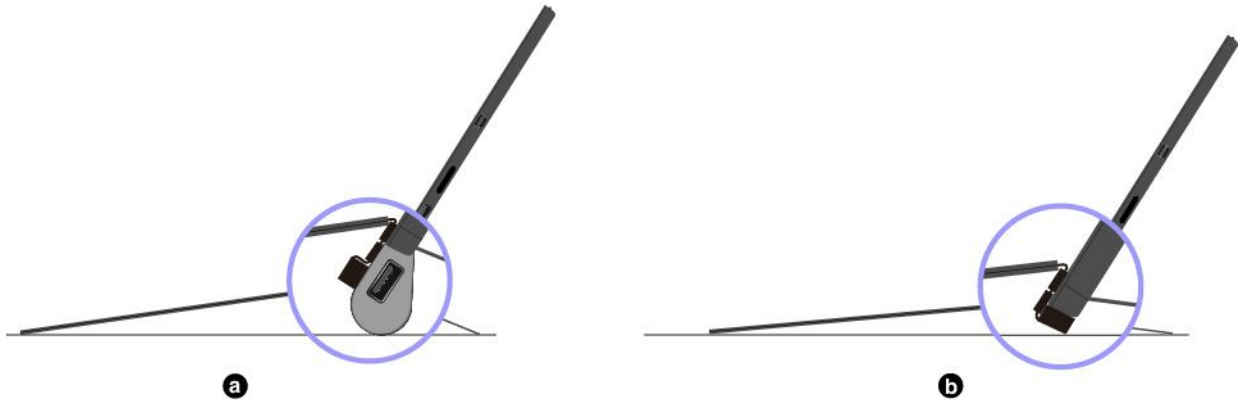

## Middle mode

Fold the living hinge and then fold the two magnetic bars together as shown. The angle between the Thin Keyboard and the table surface is about 6.9 degrees to 7.8 degrees.

**Note:** Middle mode is applicable only when the Productivity Module is attached.

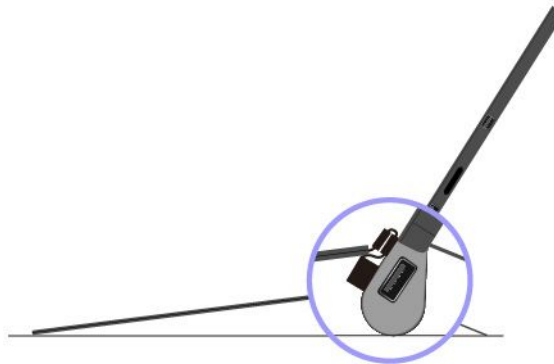

## Cover mode

Close the Thin Keyboard as shown to put the tablet into sleep mode. To wake up the tablet from sleep mode, open the Thin Keyboard and press the power button or press any key.



---

## ThinkPad Pen Pro and pen holders

Depending on the model, your tablet might come with a ThinkPad Pen Pro (referred to as the pen in this section) and pen holders. The pen enables you to write and draw in a nature manner. The pen holder helps you find a place on the tablet to store the pen.

This section introduces the basic use of the pen and the pen holders. For more information, refer to the documentation of the pen.

### Notes:

- The pen is not waterproof. Take care not to drop the pen in water.
- The pen contains pressure sensors. Do not push the tip of the pen for an extended period of time. Do not make the pen subject to shock or vibration.

### Pen overview

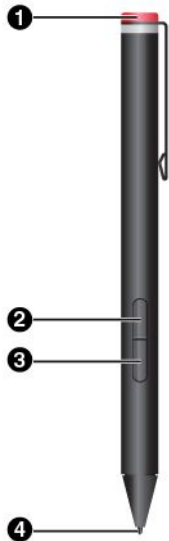

#### ❶ End cap

Unscrew the end cap to install or replace a battery.

#### ❷ Right-click button

To right-click, tap the tip on the screen and press the right-click button, or hold the pen tip on the screen for one second.

#### ❸ Eraser button

To erase text or drawing, hold down the eraser button and drag the tip across the area you want to erase.

#### ❹ Pen tip

To click, tap on the screen with the tip. To double-click, tap twice.

### ***Installing a battery to power the pen***

Depending on the model, your pen might not be installed with a battery. To install an AAAA alkaline battery, do the following:

1. Unscrew the end cap.
2. Insert an AAAA alkaline battery into the battery compartment.
3. Reinstall the end cap.
4. Tighten the end cap.

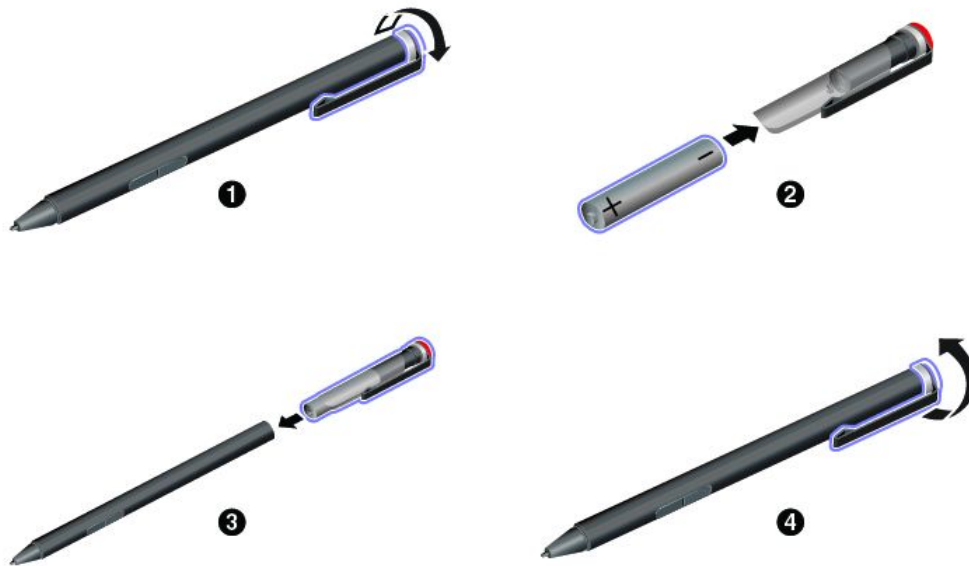

### ***Using the USB 3.0 pen holder to store the pen***

Your tablet might come with a USB 3.0 pen holder. Use this pen holder to store the pen on your tablet by doing the following:

1. Insert the pen holder into the USB 3.0 connector on your tablet.
2. Insert the pen into the pen holder horizontally or vertically.

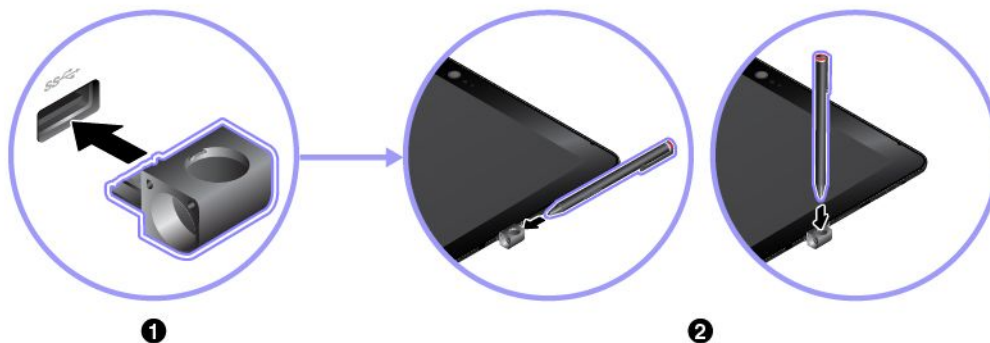

### **Using the ThinkPad X1 Tablet Thin Keyboard Pen Holder to store the pen**

Your tablet might come with a ThinkPad X1 Tablet Thin Keyboard Pen Holder. Use this pen holder to store the pen by doing the following:

1. Remove the filler on the right side of the ThinkPad X1 Tablet Thin Keyboard.
2. Insert the pen holder into the ThinkPad X1 Tablet Thin Keyboard.
3. Insert the pen into the pen holder horizontally.

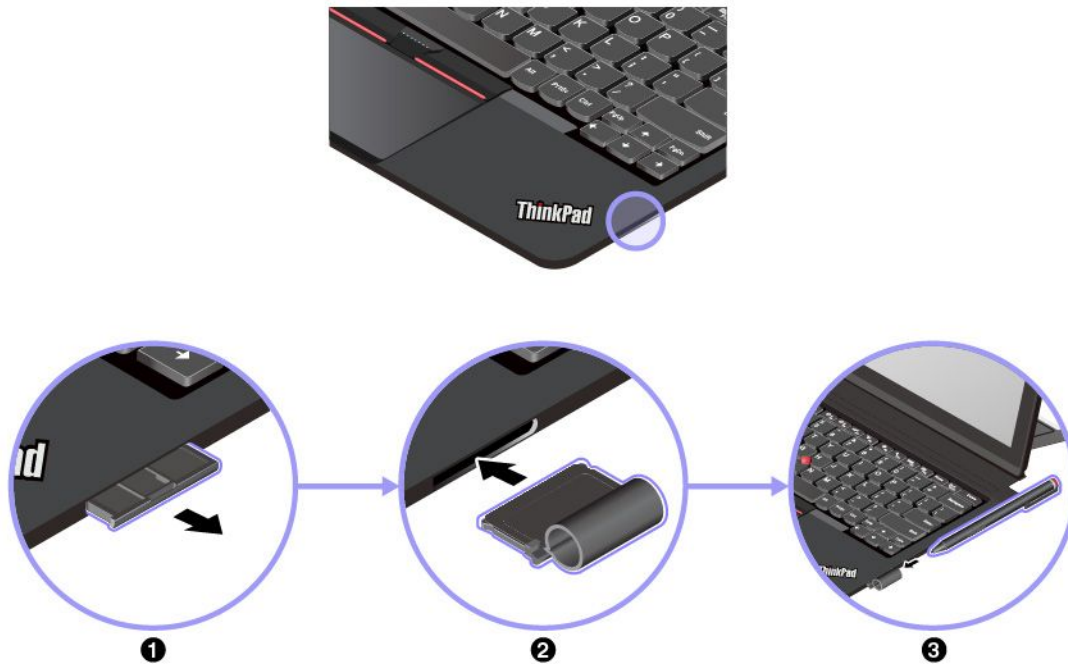

---

## **ThinkPad WiGig Dock**

The WiGig technology enables wireless communications between nearby devices at multi-gigabit speeds. Some tablet models have a wireless LAN card with built-in WiGig feature. These tablet models can work with the ThinkPad WiGig Dock wirelessly to expand computing capabilities.

## ThinkPad WiGig Dock overview

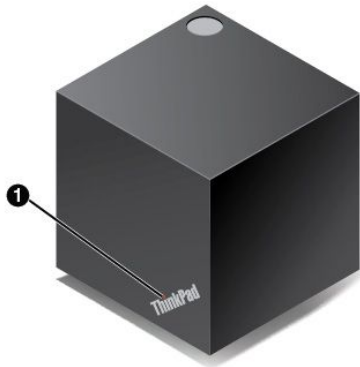

Figure 1. Front view

- 1 System-status indicator

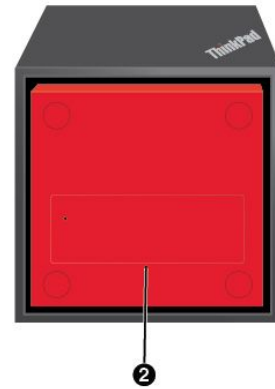

Figure 2. Bottom view

- 2 Emergency-reset hole

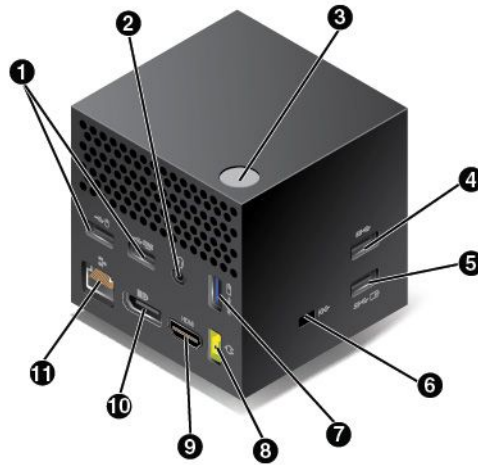
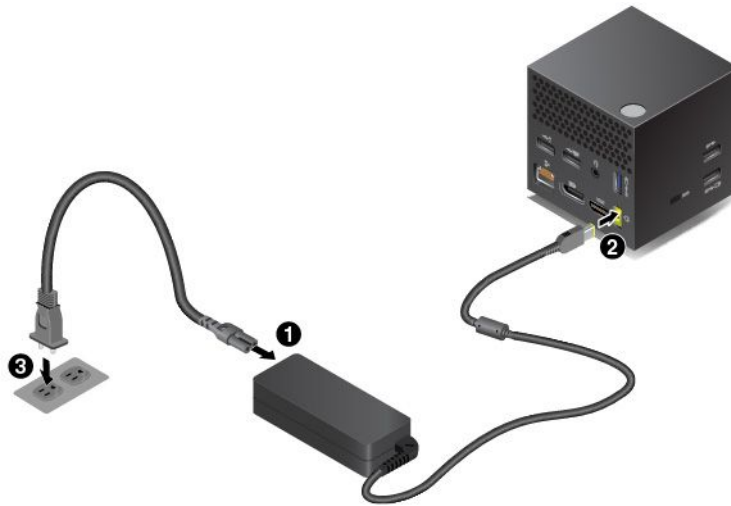

Figure 3. Side view

- 1 USB 2.0 connector
- 2 Audio connector
- 3 Power/Connection button
- 4 USB 3.0 connector
- 5 Always On USB 3.0 connector
- 6 Security-lock slot
- 7 Always On USB 3.0 connector
- 8 ac power connector
- 9 HDMI connector
- 10 DisplayPort connector
- 11 Ethernet connector

## Setting up the ThinkPad WiGig Dock



1. Connect the power cord to the ac power adapter.
2. Connect the ac power adapter to the power connector of the dock.
3. Connect the power cord to an electrical outlet.
4. Turn on the dock by pressing the power button.
5. If an external display is available, connect the external display to the appropriate connector (HDMI or DisplayPort connector) on the dock. The external display shows some wireless pairing instructions when you connect your tablet to the WiGig dock.
6. Position your tablet close to the ThinkPad WiGig Dock, within 0.9 m (3 ft). The dock also must be within a 120-degree sector region relative to the rear of the tablet.

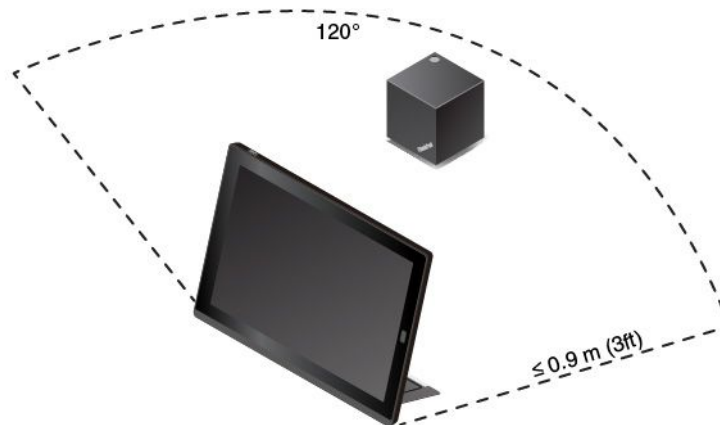

## Connecting to the ThinkPad WiGig Dock

To connect your tablet to the ThinkPad WiGig dock, do the following:

1. After the setup and preparation, turn on your tablet and the dock.
2. Tap the action center icon  on the taskbar. Tap **Connect**
3. Select your dock from the list of available devices.
4. When prompted, press the power/connection button on the dock to confirm the pairing.

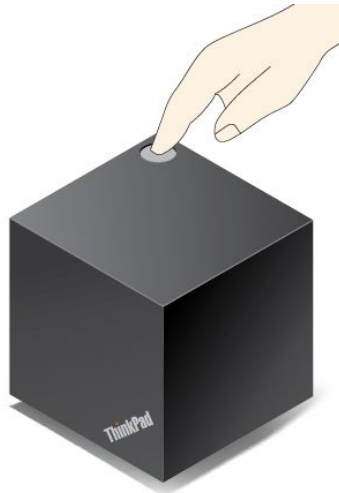

5. Follow the instructions on the screen to finish the connection.

After establishing the initial connection, you can make configurations so that whenever the tablet comes within the required range, it automatically gets connected to the dock.

#### **Disconnecting from the ThinkPad WiGig Dock**

To disconnect your tablet from the ThinkPad WiGig Dock, do the following:

1. Tap the action center icon  on the taskbar. Tap **Connect** to open the device list.
2. Locate the ThinkPad WiGig Dock and tap **Disconnect**.
3. Hold down the power button on the dock for several seconds until the dock is turned off.

#### **Managing the ThinkPad WiGig Dock**

The Wireless Dock Manager program enables you to manage the dock. You can change the name of the dock, change the radio channel to optimize the signal strength, and set a password to manage the dock settings.

To manage the ThinkPad WiGig Dock, do the following:

1. Tap the Start button to open the Start menu. Then tap **All apps** to display all programs.
2. Tap **Intel → Intel Wireless Dock Manager** to start the Wireless Dock Manager program.
3. Tap **Dock Management**.
4. Follow the instructions on the screen to configure the settings as desired.

For more information, refer to the manuals that come with the dock and the help information system of the Wireless Dock Manager program.





---

## Chapter 5. Advanced configuration

This chapter provides information about the advanced configuration and features.

---

### Installing device drivers

The device drivers are available at <http://www.lenovo.com/ThinkPadDrivers>. Choose your tablet product name to view all the device drivers for your tablet.

**Attention:** Always go to <http://www.lenovo.com/ThinkPadDrivers> for the latest device drivers. Do not download them from the Windows Update Web site.

---

### ThinkPad Tablet Setup app

The ThinkPad Tablet Setup app enables you to view and configure various setup parameters.

**Note:** The default configurations are already optimized for you. Incorrect change of the configurations might cause unexpected results.

#### *Opening the ThinkPad Tablet Setup app*

To open the ThinkPad Tablet Setup app, do the following:

**Note:** If you are required to enter the supervisor password during the process, enter the correct password. If you skip the password prompt, you still can open the ThinkPad Tablet Setup app but you cannot change the configurations.

1. Restart the tablet.
2. Tap around “Press Enter or touch here” until the ThinkPad Tablet Setup app starts.

#### *ThinkPad Tablet Setup menus*

The ThinkPad Tablet Setup app includes the following menus:

**Note:** The menus are subject to change without notice. Depending on the model, the default value might vary.

- **Main menu:** View the system information and set the date and time for your tablet.
- **Config menu:** View and change the configurations of your tablet.
- **Security menu:** Set the supervisor password and configure other security features of your tablet.
- **Startup menu:** Change the tablet startup settings.
- **Restart menu:** Choose an option for exiting the ThinkPad Tablet Setup app and restarting the system.

On each menu, tap the default value to show selectable options and tap a desired option to select it. Follow the instructions on the screen to configure the settings. After you change the settings, tap **Restart**, and then tap your desired option to restart the tablet.

---

### Updating the UEFI BIOS

The Unified Extensible Firmware Interface basic input/output system (UEFI BIOS) is a part of the system programs that make up the basic layer of software built into your tablet. The UEFI BIOS translates the instructions from other software layers.

You can update the UEFI BIOS and the ThinkPad Tablet Setup app by starting your tablet with a flash update application running in the Windows environment.

When you add software, hardware, or a device driver, you can consider updating your UEFI BIOS for the new addition to work properly.

To update your UEFI BIOS, go to:  
<http://www.lenovo.com/ThinkPadDrivers>

---

## System management

This section is intended primarily for network administrators.

The tablet is designed for manageability, so that you can redirect more of your resources to meet your business objectives better.

This manageability enables you to operate client tablets remotely in the same way as you operate your own tablet, such as turning on a client tablet, formatting the hard disk drive, and installing software.

Once the tablet is configured and operational, you can manage it by use of software and manageability features already integrated into the client system and the network.

The following content introduces some system management features.

### ***Desktop Management Interface***

The system UEFI BIOS of your tablet supports an interface called System Management BIOS Reference Specification (SMBIOS) V2.6.1. The SMBIOS provides information about the hardware components of your system. It is the responsibility of the BIOS to supply this database with information about itself and the devices on the system board. This specification documents the standards for getting access to this BIOS information.

### ***Asset ID EEPROM***

The Asset ID Electrically Erasable Programmable Read-Only Memory (EEPROM) contains information about the system, including its configuration and the serial numbers of key components. It also includes a number of blank fields in which you can record information about the end users in your network.

### ***Preboot eXecution Environment***

The Preboot eXecution Environment (PXE) technology makes the tablet more manageable by enabling the tablet to start from a server. For example, with the appropriate LAN card, your tablet can be started from the PXE server.

**Note:** The Remote Initial Program Load (RIPL or RPL) function cannot be used with your tablet.

---

## Chapter 6. Accessibility

Lenovo helps users with disabilities to access information and technology easily.

Some accessibility tools are available in the Windows operating system, and others can be purchased from third-party providers.

This section gives a brief introduction to the available accessibility tools. For details about how to use the accessibility tools, refer to the Windows help information. See “Getting help about the Windows operating system” on page 20.

---

<b>On-screen notification</b>	<p>On-screen notification helps hearing-impaired people be aware of the status of their tablet. On-screen notification replaces sounds with visual cues or text captions to indicate that activity is happening on the tablet. As a result, system alerts are noticeable even when they are not heard. For example, when you select one object, the object is highlighted.</p> <p>To use on-screen notification, open Control Panel. For information about accessing the Control Panel, see “Accessing tablet settings” on page 20. Then tap <b>Ease of Access</b> → <b>Ease of Access Center</b>, and then tap <b>Use text or visual alternative for sounds</b>.</p>
<b>Audio notification</b>	<p>Audio notification helps visually impaired people or people with weak sight be aware of the status of their tablet.</p> <p>To use audio notification, open Control Panel. For information about accessing the Control Panel, see “Accessing tablet settings” on page 20. Then tap <b>Ease of Access</b> → <b>Ease of Access Center</b> → <b>Use the computer without a display</b>, and then select <b>Turn on Audio Description</b>.</p>
<b>Narrator</b>	<p>Narrator is a screen reader that reads text on the screen aloud and describes events like error messages.</p> <p>To open Narrator, type Narrator in the search box.</p>
<b>Screen-reader technologies</b>	<p>Screen-reader technologies are primarily focused on software program interfaces, help information systems, and various online documents. For additional information about screen readers, see the following:</p> <ul style="list-style-type: none"><li>• Using the Portable Document Format (PDF) files with screen readers: <a href="http://www.adobe.com/accessibility.html?promoid=DJGVE">http://www.adobe.com/accessibility.html?promoid=DJGVE</a></li><li>• Using the JAWS screen reader: <a href="http://www.freedomscientific.com/jaws-hq.asp">http://www.freedomscientific.com/jaws-hq.asp</a></li><li>• Using the NVDA screen reader: <a href="http://www.nvaccess.org/">http://www.nvaccess.org/</a></li></ul>
<b>Speech recognition</b>	<p>Speech Recognition enables you to control your tablet by voice.</p> <p>Using only your voice, you can open apps, open menus, tap buttons and other objects on the screen, dictate text into documents, and write and send e-mails.</p> <p>To open Speech Recognition, type Speech Recognition into the search box.</p>
<b>Customizable text size</b>	<p>Depending on your preference, you can change only the text size instead of changing the size of everything on the desktop.</p> <p>To change the text size, open Control Panel. For information about accessing the Control Panel, see “Accessing tablet settings” on page 20. Then tap <b>Appearances and Personalization</b> → <b>Display</b>, go to <b>Change only the text size</b>, and set a text size that meets your needs.</p>

---

<b>Magnifier</b>	<p>Your tablet is equipped with the Microsoft Magnifier to help visually impaired people use the tablet more comfortably. Magnifier is a useful utility that enlarges part or all of your screen so that you can see the words and images better. Magnifier is part of the Ease of Access Center.</p>
	<p>To open Magnifier, type Magnifier into the search box.</p>
<b>Zoom</b>	<p>You can use the zoom feature to enlarge or reduce the size of text, pictures, maps, or other objects.</p> <ul style="list-style-type: none"> <li>• Zoom in: Move two fingers farther apart on the touch screen to enlarge the size of text, pictures, maps, or other objects.</li> <li>• Zoom out: Move two fingers closer together on the touch screen to reduce the size of text, pictures, maps, or other objects.</li> </ul>
<b>Adjustable screen resolution</b>	<p>You can make your documents easier to read by adjusting the screen resolution of your tablet. To adjust the screen resolution, tap and hold anywhere on the desktop, tap <b>Screen resolution</b> or <b>Display settings</b>, and then follow the instructions on the screen to adjust the settings as you prefer.</p> <p><b>Note:</b> Setting too low of a resolution might prevent some items from fitting on the screen.</p>
<b>Documentation in accessible formats</b>	<p>Lenovo provides electronic documentation in accessible formats, such as properly tagged PDF files or HyperText Markup Language (HTML) files. Lenovo electronic documentation is developed to ensure that visually impaired users can read the documentation through a screen reader. Each image in the documentation also includes adequate alternative text to explain the image so that visually impaired users can understand the image when they use a screen reader.</p>
<b>On-Screen Keyboard</b>	<p>On-Screen Keyboard displays a visual keyboard with all the standard keys.</p> <p>To open On-Screen Keyboard, type On-Screen Keyboard into the search box.</p>
<b>Industry-standard connectors</b>	<p>Your tablet provides industry-standard connectors that enable you to connect external devices if needed.</p>
<b>Personalized keyboard</b>	<p>If you attach the tablet to the Thin Keyboard, you can do the following to make the keyboard easier to use.</p> <ul style="list-style-type: none"> <li>• Adjust your keyboard settings by doing the following: <ol style="list-style-type: none"> <li>1. Go to Control Panel. For information about accessing the Control Panel, see “Accessing tablet settings” on page 20</li> <li>2. Tap <b>Ease of Access</b> → <b>Ease of Access Center</b> → <b>Make the keyboard easier to use</b>.</li> </ol> </li> <li>• Change the settings of the Fn key and function keys by doing the following: <ol style="list-style-type: none"> <li>1. Go to Control Panel. For information about accessing the Control Panel, see “Accessing tablet settings” on page 20. Change the view of Control Panel from Category to Large icons or Small icons.</li> <li>2. Tap <b>Keyboard</b>. In the Keyboard Properties window, tap the <b>Fn and function keys</b> tab.</li> <li>3. Select the options of your preference.</li> </ol> </li> </ul>

---

## Chapter 7. Troubleshooting

If your tablet encounters a problem, find a solution here.

---

### Frequently asked questions

The problems and solutions described in this section are meant only as a guide. They are not definitive problem-solving techniques. If a problem persists, you can get support from Lenovo. For more information, see “Lenovo Customer Support Center” on page 45.

**Attention:** When you observe a problem, stop operation immediately, because taking further action might result in data loss or damage.

---

<b>Internet problem</b>	<b><i>Failed to establish a wireless WAN connection or a mobile broadband connection?</i></b>  Ensure that: <ul style="list-style-type: none"><li>• Your tablet is not in Airplane mode.</li><li>• The nano-SIM card is valid and workable if you are using a mobile network (3G or 4G).</li><li>• You are within the network service range and the signal strength is good.</li><li>• If a USB 3.0 device is attached to your tablet, the USB 3.0 device might influence the wireless WAN connection. Detach the USB 3.0 device from your tablet to resolve the problem.</li></ul>
<b>Battery problem</b>	<b><i>Failed to charge the tablet?</i></b>  Check if the ac power adapter is connected correctly. If the connection is good but the battery still does not charge, contact Lenovo to replace the battery.
<b>System problem</b>	<b><i>Failed to power on?</i></b>  Connect your tablet to an ac power outlet to see if the drained battery caused the problem.  If the problem persists, insert a needle or a straightened paper clip into the emergency-reset hole. To locate the emergency-reset hole, see “Controls and connectors” on page 3. After resetting your tablet, try to turn it on again.  <b><i>Failed to turn the tablet off by pressing and holding the power button?</i></b>  Insert a needle or a straightened paper clip into the emergency-reset hole to reset your tablet. To locate the emergency-reset hole, see “Controls and connectors” on page 3. If you still encounter the same problem, reset the tablet to the factory default settings. See “Resetting your tablet” on page 42.

---

<b>Audio problem</b>	<b><i>Poor audio quality or no sound output?</i></b>
	<p>Ensure that:</p> <ul style="list-style-type: none"> <li>• The speaker is not covered.</li> <li>• The speaker mute function is disabled.</li> <li>• If you are using a headset, unplug it, then plug it in again.</li> <li>• The volume is not turned to the lowest level.</li> </ul>
	<b><i>Failed to play a song, video, or other media file?</i></b>
	Ensure that the media file is not corrupted.
<b>External device connection problem</b>	<b><i>Failed to detect an external display?</i></b>
	Tap and hold (right-click) anywhere on the desktop, then tap <b>Screen resolution/Display settings → Detect</b> .
	<b><i>Failed to locate Bluetooth devices?</i></b>
	<p>Ensure that:</p> <ul style="list-style-type: none"> <li>• Your tablet Bluetooth is switched on.</li> <li>• The Bluetooth feature is activated on the device to which you want to connect.</li> <li>• Your tablet and the Bluetooth device are within the maximum Bluetooth signal range (10 m, 32.8 feet).</li> </ul>
<b>Screen problem</b>	<b><i>Slow or improper responding from the multi-touch screen?</i></b>
	<ol style="list-style-type: none"> <li>1. Ensure that your hands are clean and dry when touching the screen.</li> <li>2. Restart your tablet to try again.</li> </ol>
	<b><i>Blank screen when the tablet is operating?</i></b>
	Disable any system timers, such as the liquid crystal display (LCD) turn-off timer or the blank timer, by doing the following:
	<ol style="list-style-type: none"> <li>1. Go to Control Panel. For information about accessing the Control Panel, see “Accessing tablet settings” on page 20.</li> <li>2. Tap <b>System and Security → Power Options → Balanced</b>.</li> <li>3. Follow the instructions on the screen.</li> </ol>
	<b><i>White pointer on a blank screen after power-on?</i></b>
	<ol style="list-style-type: none"> <li>1. Turn off the tablet, and then turn it on again.</li> <li>2. If you still see only the pointer on the screen, use the recovery solutions to restore the system to the factory state.</li> </ol>
	<b><i>Blank screen when the tablet is on?</i></b>
	Your screen saver or power management might have been enabled. Do either of the following:
	<ul style="list-style-type: none"> <li>• Tap the tablet screen to exit the screen saver.</li> <li>• Press the power button to resume from sleep mode.</li> </ul>

---

## **Error messages**

When the following error messages are displayed on the screen, take the corresponding solutions.

- **Message:** 0177: Bad SVP data, stop POST task.  
**Solution:** Checksum of the supervisor password in the EEPROM is not correct. The system board must be replaced. Have the tablet serviced.
- **Message:** 0183: Bad CRC of Security Settings in EFI Variable. Enter ThinkPad Setup.  
**Solution:** Checksum of the Security settings in the EFI Variable is not correct. Enter ThinkPad Setup to check security settings. Press F10, and then press Enter to restart the system. If your tablet still has a problem, have the tablet serviced.
- **Message:** 0187: EAIA data access error  
**Solution:** The access to EEPROM is failed. Have the tablet serviced.
- **Message:** 0188: Invalid RFID Serialization Information Area  
**Solution:** The EEPROM checksum is not correct (block # 0 and 1). The system board must be replaced, and the box serial number needs to be reinstalled. Have the tablet serviced.
- **Message:** 0189: Invalid RFID configuration information area  
**Solution:** The EEPROM checksum is not correct (block # 4 and 5). The system board must be replaced, and the UUID must be reinstalled. Have the tablet serviced.
- **Message:** 0190: Critical low-battery error  
**Solution:** The tablet turned off, because the battery is low. Connect the ac power adapter to the tablet and charge the battery.
- **Message:** 0191: System Security - Invalid remote change requested  
**Solution:** The system configuration change has failed. Confirm the operation and try again. To clear the error, enter ThinkPad Setup.
- **Message:** 0199: System Security - Security password retry count exceeded.  
**Solution:** This message is displayed if you enter a wrong supervisor password more than three times. Confirm the supervisor password and try again. To clear the error, enter ThinkPad Setup.
- **Message:** 0270: Real Time Clock Error  
**Solution:** System Real Time Clock is not functional. Have the tablet serviced.
- **Message:** 0271: Check Date and Time settings  
**Solution:** Neither the date nor the time is set in the tablet. Set the date and time in ThinkPad Setup.
- **Message:** 1802: Unauthorized network card is plugged in - Power off and remove the network card.  
**Solution:** The wireless network card is not supported on this tablet. Remove it.
- **Message:** 1820: More than one external fingerprint readers are attached.  
**Solution:** Power off and remove all but the reader that you set up within your main operating system.
- **Message:** 2101: Detection error on SSD1 (M.2)  
**Solution:** The M.2 solid-state drive device is not working. Have the M.2 solid-state drive device serviced.
- **Message:** 2111: Read error on SSD1 (M.2)  
**Solution:** The M.2 solid-state drive device is not working. Have the M.2 solid-state drive device serviced.
- **Message:** 2200: Machine Type and Serial Number are invalid.  
**Solution:** Machine Type and Serial Number are invalid. Have the tablet serviced.
- **Message:** 2201: Machine UUID is invalid.  
**Solution:** Machine UUID is invalid. Have the tablet serviced.
- **Message:** Fan error  
**Solution:** Cooling fan has failed. Shut down the tablet immediately and have the tablet serviced.
- **Message:** Thermal sensing error

**Solution:** The thermal sensor has a problem. Shut down the tablet immediately and have the tablet serviced.

- **Message:** Error: The non-volatile system UEFI variable storage is nearly full.

**Note:** This error indicates that the operating system or applications cannot create, modify, or delete data in the non-volatile system UEFI variable storage due to insufficient storage space after the POST.

The non-volatile system UEFI variable storage is used by the UEFI BIOS and by the operating system or applications. This error occurs when the operating system or applications store large amounts of data in the variable storage. All data needed for the POST, such as BIOS setup settings, chipset or platform configuration data, are stored in a separate UEFI variable storage.

**Solution:** Enter ThinkPad Setup after the error message is displayed. A dialog asks the user for confirmation to clean up the storage. If the user selects **Yes**, all data that were created by the operating system or applications are deleted except global variables defined by the Unified Extensible Firmware Interface Specification. If the user selects **No**, all data is kept, but the operating system or applications will not be able to create, modify, or delete data in the storage.

If this error happens at a service center, Lenovo-authorized service personnel will clean up the non-volatile system UEFI variable storage using the above solution.

---

## Lenovo Solution Center

Use Lenovo Solution Center  to troubleshoot and resolve tablet problems. The app combines diagnostic tests, system information collection, security status, and support information, along with hints and tips for maximum system performance.

For information about accessing Lenovo Solution Center, see “Discovering Lenovo apps” on page 13.

You also can download the Lenovo Solution Center app from:  
<http://www.lenovo.com/diags>

For additional information, refer to the help system of Lenovo Solution Center.

---

## Windows recovery apps

The Windows recovery apps enable you to reset your tablet or use advanced startup options.

It is recommended that you create a recovery USB drive as early as possible. Store the recovery USB drive as a backup or replacement for the Windows recovery apps.

For more information, see “Creating and using a recovery USB drive” on page 43.

## Resetting your tablet

If your tablet does not perform well, you might consider resetting your tablet. In the resetting process, you can choose to keep your files or remove them, and then reinstall the Windows operating system.

To refresh your tablet, do the following:

**Note:** The graphical user interface (GUI) items of the operating system might change without notice.

1. Open the Start menu . Tap **Settings** → **Update & security** → **Recovery**.

**Note:** **Settings** might not be displayed in the Start menu. In this case, tap **All apps** to find **Settings**.

2. In the **Reset this PC** section, tap **Get started**.



3. Follow the instructions on the screen to refresh your tablet.

## Using advanced startup options

With advanced startup options, you can change the firmware settings of the tablet, change the startup settings of the Windows operating system, start the tablet from an external device, or restore the Windows operating system from a system image.

To use advanced startup options, do the following:

**Note:** The GUI items of the operating system might change without notice.

1. Open the Start menu . Tap **Settings** → **Update & security** → **Recovery**.

**Note:** **Settings** might not be displayed in the Start menu. In this case, tap **All apps** to find **Settings**.

2. In the **Advanced startup** section, tap **Restart now** → **Troubleshoot** → **Advanced options**.
3. Select a desired startup option, then follow the instructions on the screen.

## Recovering your operating system if the Windows 10 operating system fails to start

The Windows recovery apps on your tablet are capable of operating independently from the Windows 10 operating system. This enables you to recover or repair the operating system even if the Windows 10 operating system fails to start.

After two consecutive failed boot attempts, the Windows recovery environment starts automatically. Then you can choose repair and recovery options by following the instructions on the screen.

**Note:** Ensure that your tablet is connected to ac power during the recovery process.

## Creating and using a recovery USB drive

You can create a recovery USB drive as a backup for the Windows recovery apps. With the recovery USB drive, you can troubleshoot and fix the problems even if the preinstalled Windows recovery apps are damaged.

### Creating a recovery USB drive

The USB drive that you use to create the recovery USB drive must be at least 16 GB of storage. The actual USB capacity that is required depends on the size of the recovery image.

**Attention:** The creation process deletes anything stored on the USB drive. To avoid data loss, make a backup copy of all the data that you want to keep.

To create a recovery USB drive, do the following:

**Note:** Ensure that your tablet is connected to ac power during the following process.

1. Connect a proper USB drive (at least 16 GB of storage).
2. Type **recovery** in the search box on the taskbar. Then tap **Create a recovery drive**.
3. Tap **Yes** in the User Account Control window to allow the Recovery Media Creator app to start.
4. In the Recovery Drive window, follow the on-screen instructions to create a recovery USB drive.

### Using the recovery USB drive

If you cannot start your tablet, refer to “Frequently asked questions” on page 39. If you still cannot start your tablet, use the recovery USB drive to recover your tablet.

To use a recovery USB drive, do the following:

**Note:** Ensure that your tablet is connected to ac power during the following process.

1. Connect the recovery USB drive to the tablet.
2. Open the ThinkPad Tablet Setup app. See “ThinkPad Tablet Setup app” on page 35.
3. Tap **Startup**. In the **Boot** submenu, drag the recovery drive to the first place to select it as the boot device.
4. Save configuration changes and restart the tablet.
5. Select a corresponding recovery solution according to your situation. Then follow the instructions on the screen to complete the process.

---

## Lenovo factory recovery USB key

Lenovo factory recovery USB key enables you to reset your tablet to the factory default settings.

To obtain a Lenovo factory recovery USB key, contact Lenovo Customer Support Center. Shipping and handling fees apply. For information about contacting Lenovo Customer Support Center, see “Lenovo Customer Support Center” on page 45.

**Note:** The Lenovo factory recovery USB key might not support certain operating systems. Contact Lenovo Customer Support Center for more information.

To use the Lenovo factory recovery USB key, do the following:

**Note:** Ensure that your tablet is connected to ac power during the following process.

1. Turn off the tablet, wait for about five seconds, and then connect the Lenovo factory recovery USB key to your tablet.
2. Open the ThinkPad Tablet Setup app. See “ThinkPad Tablet Setup app” on page 35.
3. Tap **Startup**. On the **Boot** submenu, drag **USB CD/DVD** or **USB HDD** to the top to make it the first startup device.
4. Tap **Save**, and then tap **Yes** to save your configuration.
5. Tap **Restart** and follow the on-screen instructions to restart the tablet. After the tablet restarts, the recovery app runs automatically.
6. Follow the on-screen instructions to reset your tablet to the factory default settings.

---

## Lenovo Support Web site

Technical support information is available on the Lenovo Support Web site at:  
<http://www.lenovo.com/support>

This Web site is updated with the latest support information:

- Drivers and software
- Diagnostic solutions
- Product and service warranty
- Guides and manuals
- Lenovo user forums

---

## Lenovo Customer Support Center

In most cases, you can solve your tablet problems by referring to the error message solutions, running diagnostic apps, or consulting the Lenovo Web site. If you still encounter tablet problems after the self-troubleshoot, contact Lenovo Customer Support Center.

If possible, be near your tablet when you make the call.

### **Before calling Lenovo**

Before you contact Lenovo, do the following preparations for a quick service:

- Registering your tablet  
Register your tablet with Lenovo so that you can get prompt support. For more information, see “Registering your tablet” on page 13.
- Installing system updates  
Installing the latest drivers or software might resolve the problems.  
To download the latest drivers or software, go to:  
<http://www.lenovo.com/support>
- Getting the proof of purchase
- Recording the machine type and serial number

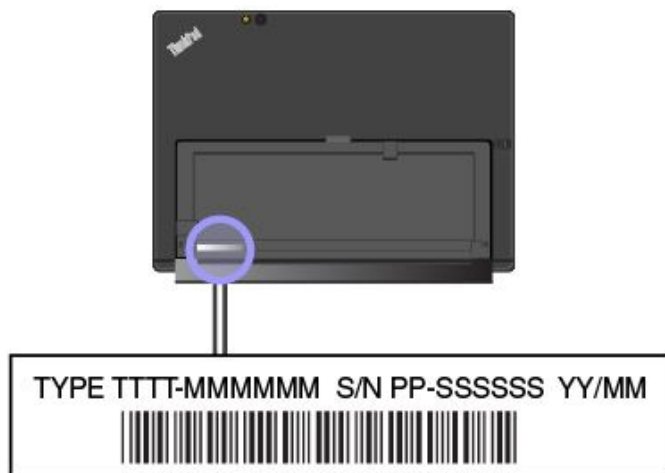

- Recording the problem details
  - What is the problem? Is it continuous or intermittent?
  - Is there an error message? What is the error code, if any?
  - What operating system are you using? Which version?
  - Which software programs were running at the time of the problem?
  - Can the problem be reproduced? If so, how?

### **Lenovo Support phone numbers**

To get the Lenovo Support phone numbers for your country or region, do one of the following:

- Refer to the *Safety, Warranty, and Setup Guide* that comes with your tablet.
- Go to <http://www.lenovo.com/support/phone>.

If the numbers for your country or region are not provided, contact your Lenovo reseller or Lenovo marketing representative.

### **Services available during the warranty period**

- Problem determination - Trained personnel are available to assist you with determining if your tablet has a hardware problem and deciding what action is necessary to fix the problem.
- Lenovo hardware repair - If the problem is caused by Lenovo hardware under warranty, trained service personnel are available to provide the applicable level of service.
- Engineering change management - Occasionally, there might be changes that are required after a product has been sold. Lenovo or your reseller, if authorized by Lenovo, will make selected Engineering Changes (ECs) that apply to your hardware available.

For the terms and conditions of the Lenovo Limited Warranty that apply to your Lenovo hardware product, see “Warranty information” in the *Safety, Warranty, and Setup Guide* that comes with your tablet.

### **Services not covered by warranty terms**

- Replacement or use of parts not manufactured for or by Lenovo or non-warranted parts
- Identification of software problem sources
- Configuration of the UEFI BIOS as part of an installation or upgrade
- Changes, modifications, or upgrades to device drivers
- Installation and maintenance of network operating systems (NOS)
- Installation and maintenance of apps

---

## **Purchasing additional services**

During and after the warranty period, you can purchase additional services, such as:

- Support for Lenovo and non-Lenovo hardware, operating systems, and apps
- Network setup and configuration services
- Upgraded or extended hardware repair services and custom installations services

**Note:** Services might vary by country or region.

For more information about additional services, go to:  
<http://www.lenovo.com/essentials>

---

## Appendix A. Regulatory information

This appendix provides regulatory information. The latest compliance information is available at:  
<http://www.lenovo.com/compliance>

---

### Certification-related information

The following table contains information about the machine types (if there are), product name, and compliance ID.

Product name	Compliance ID	Machine types
ThinkPad X1 Tablet	TP00082A	20GG and 20GH
ThinkPad X1 Tablet Thin Keyboard	TP00082K1	N/A
ThinkPad X1 Tablet Productivity Module	TP00082C1	N/A

---

### Labels for the Windows operating systems

Depending on your geographic location, the date when your tablet was manufactured, and the version of Windows 10 that is preinstalled, your tablet might have a Genuine Microsoft label affixed to its cover. See <http://www.microsoft.com/en-us/howtotell/Hardware.aspx> for illustrations of the various types of Genuine Microsoft labels.

- In the People's Republic of China, the Genuine Microsoft label is required on all tablet models preinstalled with any version of Windows 10.
- In other countries and regions, the Genuine Microsoft label is required only on tablet models licensed for Windows 10 Pro.

The absence of a Genuine Microsoft label does not indicate that the preinstalled Windows version is not genuine. For details on how to tell whether your preinstalled Windows product is genuine, refer to the information provided by Microsoft at <http://www.microsoft.com/en-us/howtotell/default.aspx>.

The Product ID is recorded in the product firmware. Whenever a Windows 10 product is installed, the installation program checks the product firmware for a valid, matching Product ID to complete the activation.

In some cases, an earlier Windows version might be preinstalled under the terms of the Windows 10 Pro license downgrade rights.

---

### Wireless-related information

#### Wireless interoperability

The wireless LAN card is interoperable with any wireless LAN product that is based on Direct Sequence Spread Spectrum (DSSS), Complementary Code Keying (CCK), and/or Orthogonal Frequency Division Multiplexing (OFDM) radio technology, and is compliant to:

- The 802.11b/g Standard, 802.11a/b/g, 802.11n, or 802.11ac on Wireless LANs, as defined and approved by the Institute of Electrical and Electronics Engineers.
- The Wi-Fi certification as defined by the Wi-Fi Alliance.

The Bluetooth card in your tablet is interoperable with any Bluetooth product that is compliant to Bluetooth Specification 4.1 as defined by the Bluetooth SIG. Your Bluetooth card supports the following profiles:

**Note:** Depending on the Bluetooth card, some profile might not be available.

- Advanced Audio Distribution Profile (A2DP)
- A/V Remote Control Profile (AVRCP)
- Dial-Up Networking Profile (DUN)
- File Transfer Profile (FTP)
- Generic Access Profile (GAP)
- Generic A/V Distribution Profile (GAVDP)
- Hardcopy Cable Replacement Profile (HCRP)
- Headset Profile (HSP)
- Hands-Free Profile (HFP)
- Human Interface Device Profile (HID)
- Message Access Profile (MAP)
- Object Exchange Protocol (OBEX)
- Object Push Profile (OPP)
- Personal Area Networking Profile (PAN)
- Phone Book Access Profile (PBAP)
- Service Discovery Protocol (SDP)
- Synchronization Profile (SYNC)
- Video Distribution Profile (VDP)
- Generic Attribute Profile (GATT)
- Proximity Profile

## Locating the UltraConnect™ wireless antennas

ThinkPad X1 Tablet features an antenna system built into the display for optimal reception, which enables you to establish wireless communications wherever you are.

The following illustration shows the location of each built-in wireless antenna.

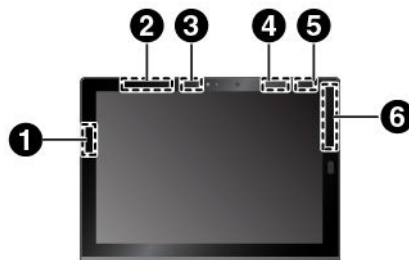

- ❶ Wireless-LAN antenna (main)
- ❷ Wireless-WAN antenna (auxiliary) \*
- ❸ Wireless-LAN antenna (auxiliary)
- ❹ WiGig antenna \*
- ❺ NFC antenna \*
- ❻ Wireless-WAN antenna (main) \*

\* Available on some models

## Wireless-radio compliance information

Tablet models equipped with wireless communications comply with the radio frequency and safety standards of any country/region where it has been approved for wireless use.

### ***Brazil wireless-radio compliance information***

Este equipamento opera em caráter secundário, isto é, não tem direito a proteção contra interferência prejudicial, mesmo de estações do mesmo tipo, e não pode causar interferência a sistemas operando em caráter primário.

This equipment is a secondary type device, that is, it is not protected against harmful interference, even if the interference is caused by a device of the same type, and it also cannot cause any interference to primary type devices.

### ***Mexico wireless-radio compliance information***

Advertencia: En Mexico la operación de este equipo está sujeta a las siguientes dos condiciones: (1) es posible que este equipo o dispositivo no cause interferencia perjudicial y (2) este equipo o dispositivo debe aceptar cualquier interferencia, incluyendo la que pueda causar su operación no deseada.

### ***Locating the FCC ID or IC Certification information***

You can find the Federal Communications Commission ID (FCC ID) or Industry Canada (IC) Certification information on your tablet.

**Note:** Your tablet might look slightly different from the following illustration.

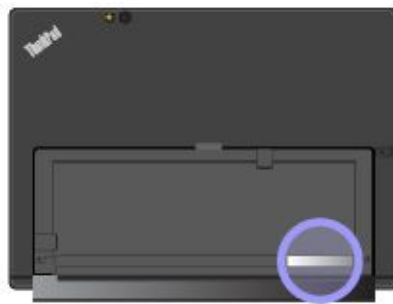

### ***Reading the Regulatory Notice***

For more information about wireless-radio compliance information, refer to the *Regulatory Notice* shipped with the tablet. If your tablet is not shipped with *Regulatory Notice*, find the document at: <http://www.lenovo.com/UserManuals>

## **Usage environment and your health**

This tablet contains integrated wireless cards that operate within the guidelines identified by radio frequency (RF) safety standards and recommendations; therefore, Lenovo believes this product is safe for use by consumers. These standards and recommendations reflect the consensus of the worldwide scientific community, and result from deliberations of panels and committees of scientists, who continually review and interpret the extensive research literature.

Refer to the *Regulatory Notice* to obtain detailed information related to the Specific Absorption Rate (SAR) for your tablet. To locate the *Regulatory Notice*, see “Wireless-radio compliance information” on page 48.

In some situations or environments, the use of wireless devices might be restricted by the proprietor of a building or responsible representatives of an organization. For example, these situations and areas might include the following:

- On board of airplanes, in hospitals or near petrol stations, blasting areas (with electro-explosive devices), medical implants or body-worn electronic medical devices, such as pace makers.

- In any other environment where the risk of interference to other devices or services is perceived or identified as harmful.

If you are uncertain of the policy that applies to the use of wireless devices in a specific area (such as an airport or hospital), you are encouraged to ask for authorization to use a wireless device prior to turning on the tablet.

---

## Electronic emission notice

### Federal Communications Commission Declaration of Conformity

The following information refers to the ThinkPad X1 tablet, machine types: 20GG and 20GH.

This equipment has been tested and found to comply with the limits for a Class B digital device, pursuant to Part 15 of the FCC Rules. These limits are designed to provide reasonable protection against harmful interference in a residential installation. This equipment generates, uses, and can radiate radio frequency energy and, if not installed and used in accordance with the instructions, may cause harmful interference to radio communications. However, there is no guarantee that interference will not occur in a particular installation. If this equipment does cause harmful interference to radio or television reception, which can be determined by turning the equipment off and on, the user is encouraged to try to correct the interference by one or more of the following measures:

- Reorient or relocate the receiving antenna.
- Increase the separation between the equipment and receiver.
- Connect the equipment into an outlet on a circuit different from that to which the receiver is connected.
- Consult an authorized dealer or service representative for help.

Lenovo is not responsible for any radio or television interference caused by using other than specified or recommended cables and connectors or by unauthorized changes or modifications to this equipment. Unauthorized changes or modifications could void the user's authority to operate the equipment.

This device complies with Part 15 of the FCC Rules. Operation is subject to the following two conditions: (1) this device may not cause harmful interference, and (2) this device must accept any interference received, including interference that may cause undesired operation.

Responsible Party:

Lenovo (United States) Incorporated  
1009 Think Place - Building One  
Morrisville, NC 27560  
Phone Number: 919-294-5900



### Industry Canada Class B emission compliance statement

CAN ICES-3(B)/NMB-3(B)

### European Union - Compliance to the Electromagnetic Compatibility Directive

This product is in conformity with the protection requirements of EU Council Directive 2004/108/EC on the approximation of the laws of the Member States relating to electromagnetic compatibility. Lenovo cannot



accept responsibility for any failure to satisfy the protection requirements resulting from a nonrecommended modification of the product, including the installation of option cards from other manufacturers.

This product has been tested and found to comply with the limits for Class B Information Technology Equipment according to European Standard EN 55022. The limits for Class B equipment were derived for typical residential environments to provide reasonable protection against interference with licensed communication devices.

EU Contact: Lenovo, Einsteinova 21, 851 01 Bratislava, Slovakia



## German Class B compliance statement

### Deutschsprachiger EU Hinweis:

#### Hinweis für Geräte der Klasse B EU-Richtlinie zur Elektromagnetischen Verträglichkeit

Dieses Produkt entspricht den Schutzanforderungen der EU-Richtlinie 2004/108/EG (früher 89/336/EWG) zur Angleichung der Rechtsvorschriften über die elektromagnetische Verträglichkeit in den EU-Mitgliedsstaaten und hält die Grenzwerte der EN 55022 Klasse B ein.

Um dieses sicherzustellen, sind die Geräte wie in den Handbüchern beschrieben zu installieren und zu betreiben. Des Weiteren dürfen auch nur von der Lenovo empfohlene Kabel angeschlossen werden. Lenovo übernimmt keine Verantwortung für die Einhaltung der Schutzanforderungen, wenn das Produkt ohne Zustimmung der Lenovo verändert bzw. wenn Erweiterungskomponenten von Fremdherstellern ohne Empfehlung der Lenovo gesteckt/eingebaut werden.

### Deutschland:

#### Einhaltung des Gesetzes über die elektromagnetische Verträglichkeit von Betriebsmitteln

Dieses Produkt entspricht dem „Gesetz über die elektromagnetische Verträglichkeit von Betriebsmitteln“ EMVG (früher „Gesetz über die elektromagnetische Verträglichkeit von Geräten“). Dies ist die Umsetzung der EU-Richtlinie 2004/108/EG (früher 89/336/EWG) in der Bundesrepublik Deutschland.

#### Zulassungsbescheinigung laut dem Deutschen Gesetz über die elektromagnetische Verträglichkeit von Betriebsmitteln, EMVG vom 20. Juli 2007 (früher Gesetz über die elektromagnetische Verträglichkeit von Geräten), bzw. der EMV EG Richtlinie 2004/108/EC (früher 89/336/EWG), für Geräte der Klasse B.

Dieses Gerät ist berechtigt, in Übereinstimmung mit dem Deutschen EMVG das EG-Konformitätszeichen - CE - zu führen. Verantwortlich für die Konformitätserklärung nach Paragraf 5 des EMVG ist die Lenovo (Deutschland) GmbH, Gropiusplatz 10, D-70563 Stuttgart.

Informationen in Hinsicht EMVG Paragraf 4 Abs. (1) 4:

**Das Gerät erfüllt die Schutzanforderungen nach EN 55024 und EN 55022 Klasse B.**

## Korea Class B compliance statement

B급 기기 (가정용 방송통신기자재)
이 기기는 가정용(B급) 전자파적합기기로서 주로 가정에서 사용하는 것을 목적으로 하며, 모든 지역에서 사용할 수 있습니다

## Japanese VCCI Class B statement

この装置は、クラスB情報技術装置です。この装置は、家庭環境で使用することを目的としていますが、この装置がラジオやテレビジョン受信機に近接して使用されると、受信障害を引き起こすことがあります。

取扱説明書に従って正しい取り扱いをして下さい。

VCCI-B

## Japan compliance statement for products which connect to the power mains with rated current less than or equal to 20 A per phase

日本の定格電流が 20A/相 以下の機器に対する高調波電流規制  
高調波電流規格 JIS C 61000-3-2 適合品

## Japan notice for ac power cord

The ac power cord shipped with your product can be used only for this specific product. Do not use the ac power cord for other devices.

本製品およびオプションに電源コード・セットが付属する場合は、それぞれ専用のものになっていますので他の電気機器には使用しないでください。

## Lenovo product service information for Taiwan

台灣 Lenovo 產品服務資訊如下：  
荷蘭商聯想股份有限公司台灣分公司  
台北市內湖區堤頂大道二段89號5樓  
服務電話：0800-000-702

---

## WEEE and recycling information

Lenovo encourages owners of information technology (IT) equipment to recycle their equipment responsibly when it is no longer needed. Lenovo offers various programs and services to assist equipment owners in recycling their IT products. The latest environmental information is available at:  
<http://www.lenovo.com/ecodeclaration>

## Important WEEE information

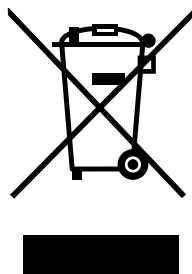

The WEEE marking on Lenovo products applies to countries with WEEE and e-waste regulations (for example, European WEEE Directive, India E-Waste Management & Handling Rules, 2011). Appliances are labeled in accordance with local regulations concerning waste electrical and electronic equipment (WEEE). These regulations determine the framework for the return and recycling of used appliances as applicable within each geography. This label is applied to various products to indicate that the product is not to be thrown away, but rather put in the established collective systems for reclaiming these end-of-life products.

Users of electrical and electronic equipment (EEE) with the WEEE marking must not dispose of end of life EEE as unsorted municipal waste, but use the collection framework available to them for the return, recycle, and recovery of WEEE and to minimize any potential effects of EEE on the environment and human health due to the presence of hazardous substances. For additional WEEE information, go to:

<http://www.lenovo.com/recycling>

## Recycling information for China

### 《废弃电器电子产品回收处理管理条例》提示性说明

联想鼓励拥有联想品牌产品的用户当不再需要此类产品时，遵守国家废弃电器电子产品回收处理相关法律法规，将其交给当地具有国家认可的回收处理资质的厂商进行回收处理。更多回收服务信息，请点击进入

<http://support.lenovo.com.cn/activity/551.htm>

## Recycling information for Japan

### *Collecting and recycling a disused Lenovo computer or monitor*

If you are a company employee and need to dispose of a Lenovo computer or monitor that is the property of the company, you must do so in accordance with the Law for Promotion of Effective Utilization of Resources. Computers and monitors are categorized as industrial waste and should be properly disposed of by an industrial waste disposal contractor certified by a local government. In accordance with the Law for Promotion of Effective Utilization of Resources, Lenovo Japan provides, through its PC Collecting and Recycling Services, for the collecting, reuse, and recycling of disused computers and monitors. For details, visit the Lenovo Web site at <http://www.lenovo.com/recycling/japan>.

Pursuant to the Law for Promotion of Effective Utilization of Resources, the collecting and recycling of home-used computers and monitors by the manufacturer was begun on October 1, 2003. This service is provided free of charge for home-used computers sold after October 1, 2003. For details, go to: <http://www.lenovo.com/recycling/japan>.

### *Disposing of Lenovo computer components*

Some Lenovo computer products sold in Japan may have components that contain heavy metals or other environmental sensitive substances. To dispose of disused components properly, such as a printed circuit board or drive, use the methods described above for collecting and recycling a disused computer or monitor.

### *Disposing of disused lithium batteries from Lenovo computers*

A button-shaped lithium battery is installed inside your Lenovo computer to provide power to the computer clock while the computer is off or disconnected from the main power source. If you want to replace it with a new one, contact your place of purchase or contact Lenovo for service. If you need to dispose of a disused lithium battery, insulate it with vinyl tape, contact your place of purchase or an industrial-waste-disposal operator, and follow their instructions.

Disposal of a lithium battery must comply with local ordinances and regulations.

### *Disposing of a disused battery pack from Lenovo notebook computers*

Your Lenovo notebook computer has a lithium ion battery pack or a nickel metal hydride battery pack. If you are a company employee who uses a Lenovo notebook computer and need to dispose of a battery pack, contact the proper person in Lenovo sales, service, or marketing, and follow that person's instructions. You also can refer to the instructions at:

<http://www.lenovo.com/jp/ja/environment/recycle/battery/>.

If you use a Lenovo notebook computer at home and need to dispose of a battery pack, you must comply with local ordinances and regulations. You also can refer to the instructions at: <http://www.lenovo.com/jp/ja/environment/recycle/battery/>.

## Recycling information for Brazil

### *Declarações de Reciclagem no Brasil*

#### **Descarte de um Produto Lenovo Fora de Uso**

Equipamentos elétricos e eletrônicos não devem ser descartados em lixo comum, mas enviados à pontos de coleta, autorizados pelo fabricante do produto para que sejam encaminhados e processados por empresas especializadas no manuseio de resíduos industriais, devidamente certificadas pelos órgãos ambientais, de acordo com a legislação local.

A Lenovo possui um canal específico para auxiliá-lo no descarte desses produtos. Caso você possua um produto Lenovo em situação de descarte, ligue para o nosso SAC ou encaminhe um e-mail para: [reciclar@lenovo.com](mailto:reciclar@lenovo.com), informando o modelo, número de série e cidade, a fim de enviarmos as instruções para o correto descarte do seu produto Lenovo.

## Battery recycling information for Taiwan



廢電池請回收

## Battery recycling information for the United States and Canada



US & Canada Only

## Battery recycling information for the European Union

EU

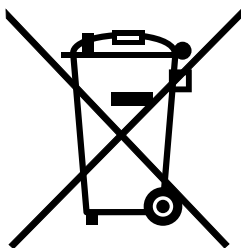

**Notice:** This mark applies only to countries within the European Union (EU).

Batteries or packaging for batteries are labeled in accordance with European Directive 2006/66/EC concerning batteries and accumulators and waste batteries and accumulators. The Directive determines the framework for the return and recycling of used batteries and accumulators as applicable throughout the

European Union. This label is applied to various batteries to indicate that the battery is not to be thrown away, but rather reclaimed upon end of life per this Directive.

In accordance with the European Directive 2006/66/EC, batteries and accumulators are labeled to indicate that they are to be collected separately and recycled at end of life. The label on the battery may also include a chemical symbol for the metal concerned in the battery (Pb for lead, Hg for mercury, and Cd for cadmium). Users of batteries and accumulators must not dispose of batteries and accumulators as unsorted municipal waste, but use the collection framework available to customers for the return, recycling, and treatment of batteries and accumulators. Customer participation is important to minimize any potential effects of batteries and accumulators on the environment and human health due to the potential presence of hazardous substances. For proper collection and treatment, go to:  
<http://www.lenovo.com/recycling>

## Recycling information for China

### 《废弃电器电子产品回收处理管理条例》提示性说明

联想鼓励拥有联想品牌产品的用户当不再需要此类产品时，遵守国家废弃电器电子产品回收处理相关法律法规，将其交给当地具有国家认可的回收处理资质的厂商进行回收处理。更多回收服务信息，请点击进入

<http://support.lenovo.com.cn/activity/551.htm>

---

## Restriction of Hazardous Substances Directive (RoHS)

The latest environmental information is available at:  
<http://www.lenovo.com/ecodeclaration>

## European Union RoHS

This Lenovo product, with included parts (cables, cords, and so on) meets the requirements of Directive 2011/65/EU on the restriction of the use of certain hazardous substances in electrical and electronic equipment (“RoHS recast” or “RoHS 2”).

For more information about Lenovo worldwide compliance on RoHS, go to:  
[http://www.lenovo.com/social\\_responsibility/us/en/RoHS\\_Communication.pdf](http://www.lenovo.com/social_responsibility/us/en/RoHS_Communication.pdf)

## China RoHS

### 产品中有害物质的名称及含量

部件名称	铅 (Pb)	汞 (Hg)	镉 (Cd)	六价铬 (Cr (VI) )	多溴联苯 (PBB)	多溴二苯醚 (PBDE)
印刷电路板组件	X	0	0	0	0	0
硬盘	X	0	0	0	0	0
光驱	X	0	0	0	0	0
LCD 面板 (LED 背光源)	X	0	0	0	0	0
键盘	X	0	0	0	0	0
内存	X	0	0	0	0	0
电池	X	0	0	0	0	0
电源适配器	X	0	0	0	0	0
底壳、顶盖和扬声器	X	0	0	0	0	0

**注：**

本表依据SJ/T 11364的规定编制。

**0：**表示该有害物质在该部件所有均质材料中的含量均在 GB/T 26572标准规定的限量要求以下。

**X：**表示该有害物质至少在该部件的某一均质材料中的含量超出GB/T 26572标准规定的限量要求。标有“X”的部件，皆因全球技术发展水平限制而无法实现有害物质的替代。印刷电路板组件包括印刷电路板（PCB）及其组件、集成电路（IC）和连接器。某些型号的产品可能不包含上表中的某些部件，请以实际购买机型为准。

**图示：**



在中华人民共和国境内销售的电子信息产品上将印有“环保使用期限”（EPuP）符号。圆圈中的数字代表产品的正常环保使用期限。

## Turkish RoHS

The Lenovo product meets the requirements of the Republic of Turkey Directive on the Restriction of the Use of Certain Hazardous Substances in Waste Electrical and Electronic Equipment (WEEE).

## Türkiye AEEE Yönetmeliğine Uygunluk Beyanı

Bu Lenovo ürünü, T.C. Çevre ve Orman Bakanlığı'nın "Atık Elektrik ve Elektronik Eşyalarda Bazı Zararlı Maddelerin Kullanımının Sınırlandırılmasına Dair Yönetmelik (AEEE)" direktiflerine uygundur.

AEEE Yönetmeliğine Uygundur.

## Ukraine RoHS

Цим підтверджуємо, що продукція Леново відповідає вимогам нормативних актів України, які обмежують вміст небезпечних речовин

## India RoHS

RoHS compliant as per E-Waste (Management & Handling) Rules, 2011.

---

## Additional compliance information

### Brazil audio notice

Ouvir sons com mais de 85 decibéis por longos períodos pode provocar danos ao sistema auditivo.

### Eurasian compliance mark



### ENERGY STAR model information



ENERGY STAR® is a joint program of the U.S. Environmental Protection Agency and the U.S. Department of Energy aimed at saving money and protecting the environment through energy efficient products and practices.

Lenovo is proud to offer our customers products with the ENERGY STAR qualified designation. You might find an ENERGY STAR mark affixed on the computer or displayed on the power settings interface. Lenovo tablets of the following machine types, if carry an ENERGY STAR mark, have been designed and tested to conform to the ENERGY STAR program requirements for tablets.

20GG and 20GH

By using ENERGY STAR qualified products and taking advantage of the power-management features of the tablet, you can help reduce the consumption of electricity. Reduced electrical consumption can contribute to potential financial savings, a cleaner environment, and the reduction of greenhouse gas emissions.

For more information about ENERGY STAR, go to:  
<http://www.energystar.gov>

Lenovo encourages you to make efficient use of energy an integral part of your day-to-day operations. To help in this endeavor, Lenovo has preset the following power-management features to take effect when the tablet has been inactive for a specified length of time:

**Power plan: Balanced (settings when plugged into ac power)**

- Put the tablet into sleep: After 10 minutes

To awaken the tablet from sleep mode, press the power button. For more information about these settings, refer to the Windows help information. See “Getting help about the Windows operating system” on page 20.

## **Export classification notice**

This product is subject to the United States Export Administration Regulations (EAR) and has an Export Classification Control Number (ECCN) of 5A992.c. It can be re-exported except to any of the embargoed countries in the EAR E1 country list.



---

## Appendix B. Trademarks

The following terms are trademarks of Lenovo in the United States, other countries, or both:

- Lenovo
- Lenovo logo
- ThinkPad
- ThinkPad logo
- UltraConnect

Microsoft, Windows, and Cortana are trademarks of the Microsoft group of companies.

The terms HDMI and HDMI High-Definition Multimedia Interface are trademarks or registered trademarks of HDMI Licensing LLC in the United States and other countries.

Mini DisplayPort (mDP) is a trademark of the Video Electronics Standards Association.

Other company, product, and service names may be trademarks or service marks of others.





**Lenovo**<sup>™</sup>