



Operation Manual

Smart-UPS™

Uninterruptible Power Supply

Rack-Mount 1U

1200/1500 VA
100/120/230 Vac

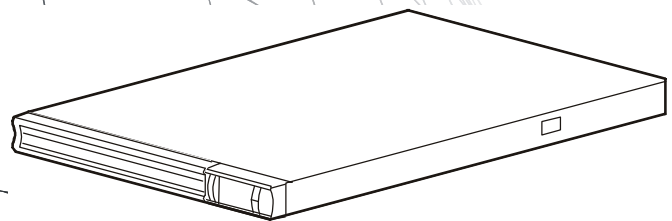

General Information

Important Safety Messages

SAVE THESE INSTRUCTIONS - This manual contains important instructions that should be followed during installation and maintenance of the Smart-UPS and batteries.

Read these instructions carefully and look at the equipment to become familiar with the equipment before attempting to install, operate, service or maintain the UPS. The following special messages may appear throughout this manual or on the equipment to warn of potential hazards or to call attention to information that clarifies or simplifies a procedure.



The addition of this symbol to a Danger or Warning product safety label indicates that an electrical hazard exists which will result in personal injury if the instructions are not followed.



The addition of this symbol to a Warning or Caution product safety label indicates that a hazard exists that can result in injury and product damage if the instructions are not followed.

 DANGER
DANGER indicates a hazardous situation which, if not avoided, will result in death or serious injury.
 WARNING
WARNING indicates a hazardous situation which, if not avoided, could result in death or serious injury.
 CAUTION
CAUTION indicates a hazardous situation which, if not avoided, could result in minor or moderate injury.
NOTICE
NOTICE is used to address practices not related to physical injury.

Product Handling Guidelines

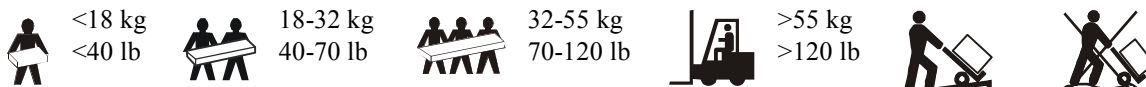

Safety and General Information

- Adhere to all national and local electrical codes.
- All wiring must be performed by a qualified electrician.
- Changes and modifications to this unit not expressly approved by APC could void the warranty.
- This UPS is intended for indoor use only.
- Do not operate this UPS in direct sunlight, in contact with fluids, or where there is excessive dust or humidity.
- Be sure the air vents on the UPS are not blocked. Allow adequate space for proper ventilation.
- For a UPS with a factory installed power cord, connect the UPS power cable directly to a wall outlet. Do not use surge protectors or extension cords.
- The battery typically lasts for three to five years. Environmental factors impact battery life. Elevated ambient temperatures, poor quality utility power, and frequent short duration discharges will shorten battery life.
- Replace the battery immediately when the UPS indicates battery replacement is necessary.
- The equipment is heavy. Always practice safe lifting techniques adequate for the weight of the equipment.
- The batteries are heavy. Remove the batteries before installing the UPS and external battery packs (XLBPs), in a rack.
- Always install XLBPs at the bottom in rack-mount configurations. The UPS must be installed above the XLBPs.
- Always install peripheral equipment above the UPS in rack-mount configurations.
- Additional safety information can be found in the Safety Guide supplied with this unit.

Product Description

The APC by Schneider Electric Smart-UPS™ is a high performance uninterruptible power supply (UPS). The UPS helps to provide protection for electronic equipment from utility power blackouts, brownouts, sags, surges, small utility power fluctuations and large disturbances. The UPS also provides battery backup power for connected equipment until utility power returns to acceptable levels or the batteries are completely discharged.

This user manual is available on the enclosed Documentation CD. Download the latest version (if any) of the user manual from the APC by Schneider Electric web site, www.apc.com.

Specifications



For additional specifications, refer to the APC by Schneider Electric Web site at www.apc.com.

Weight Specifications	UPS + Battery Pack	Battery Pack
	24 kg (53 lb)	10.5 kg (23 lb)
Temperature	Operating	0° to 40° C (32° to 104° F)
	Storage	-15° to 45° C (5° to 113° F) charge UPS battery every six months
Maximum Elevation	Operating	3,000 m (10,000 ft)
	Storage	15,000 m (50,000 ft)
Humidity	0% to 95% relative humidity, non-condensing	0° to 40° C (32° to 104° F)

Battery

⚠ CAUTION
<p>RISK OF HYDROGEN SULPHIDE GAS AND EXCESSIVE SMOKE</p> <ul style="list-style-type: none"> • Replace the battery at least every 5 years. • Replace the battery immediately when the UPS indicates battery replacement is necessary. • Replace battery at the end of its service life. • Replace batteries with the same number and type of batteries as originally installed in the equipment. • Replace the battery immediately when the UPS indicates a battery overtemperature condition, or UPS internal overtemperature, or when there is evidence of electrolyte leakage. Power off the UPS, unplug it from the AC input, and disconnect the batteries. Do not operate the UPS until the batteries have been replaced. • *Replace all battery modules (including the modules in External Battery Packs) which are older than one year, when installing additional battery packs or replacing the battery module(s). <p>Failure to follow these instructions could result in equipment damage and minor or moderate injury.</p>

*Contact APC by Schneider Electric Worldwide Customer Support to determine the age of the installed battery modules.

	UPS model	Replacement Battery Pack
Maintenance free, sealed lead acid	SMT1200RMJ1U	APCRBC88J
	SMT1500RM1U	APCRBC88
	SMT1500RMI1U	APCRBC88
 	Replace used batteries with APC by Schneider Electric approved batteries. To order a replacement battery go to the APC by Schneider Electric Web site, www.apc.com . Always recycle used batteries. For information on recycling a used battery, refer to the Battery Disposal Information sheet included with the replacement battery.	

Product Overview

Front panel features

- ❶ Battery
- ❷ Battery connector
- ❸ Display interface
- ❹ Bezel

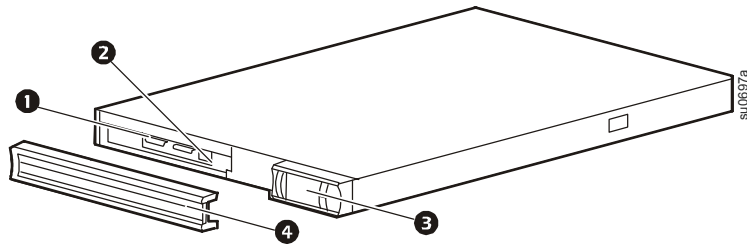

Rear panel features

1200/1500 VA 100/120 Vac



1500 VA 230 Vac

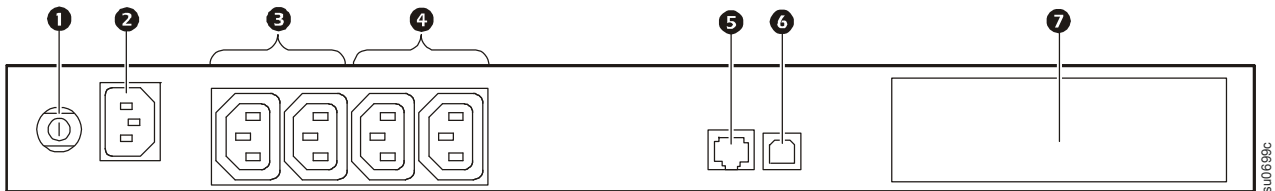

- ❶ Circuit breaker/Overload protection
- ❷ UPS input
- ❸ Controlled outlet group 1
- ❹ Controlled outlet group 2
- ❺ RJ45 connector - serial UPS monitoring port
- ❻ USB port
- ❼ SmartSlot for optional accessory card

Installation

For UPS installation information, refer to the Smart-UPS 1200/1500 VA 100/120/230 Vac Rack-Mount 1U Installation Guide that is included with the UPS. The Installation Guide is also available on the Documentation CD included with the UPS and on the APC by Schneider Electric Web site, www.apc.com.

Operation

Connect Equipment

CAUTION

RISK OF ELECTRIC SHOCK

- Adhere to all local and national electrical codes.
- Wiring should be performed by qualified electrician.
- Always connect the UPS to a grounded outlet.

Failure to follow these instructions can result in minor or moderate injury

Note: The UPS will charge to 90% capacity in the first three hours of normal operation. **Do not expect full battery runtime capability during this initial charge period.**

1. Connect equipment to the outlets on the rear panel of the UPS.
2. Connect the UPS to the building utility power. **Connect the UPS to a two pole, three wire, grounded source only.**
3. To use the UPS as a MASTER ON/OFF switch, turn on equipment that is connected to the UPS.
4. To turn on the UPS and all connected equipment press the ON/OFF button on the front panel of the UPS.
5. Refer to “Switched Outlet Groups” on page 12 for information on switched outlet group configuration.

Outlet type and location may vary.

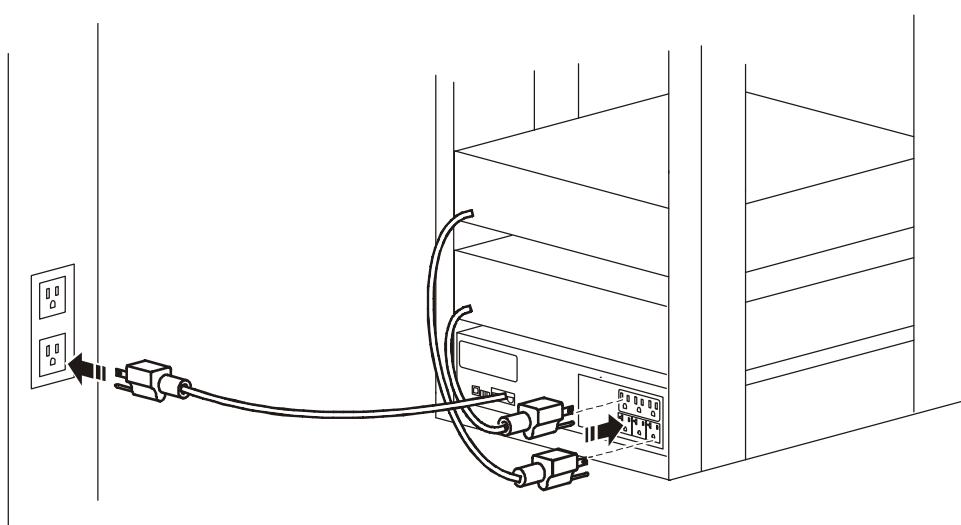

Rear panel features



Serial port: Connect a computer to use power management software.



USB port: Connect a computer to use power management software.

Display Panel

Overview

- ❶ Online LED
- ❷ On Battery LED
- ❸ Alert LED
- ❹ Replace Battery LED
- ❺ UP/DOWN arrow buttons
- ❻ Display screen
- ❼ ENTER button
- ❽ UPS ON/OFF button
- ❾ ESCAPE button

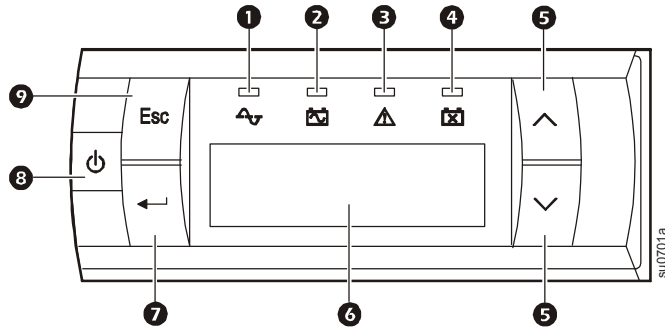

Display interface operation

Press either the ESC or ENTER buttons to access the main menu.

Use the UP/DOWN arrow buttons to scroll through menu options.

Press ENTER to view sub menus. Scroll through the list of options. Press ENTER to select an option.

Press ESCAPE to exit a sub menu and return to a main menu.

Menu overview

The display interface has Standard and Advanced menu screens. The preference for Standard or Advanced menu options is made during initial installation and can be changed at any time using the Configuration menu.

Standard menus are the most commonly used menus. The default screen shows Load and Battery Capacity bar graphs.

The Advanced menus include more status information and additional sub menus. The default screen shows scrolling status information.

Note: Actual menu screens may differ by model and firmware revision.

Main Menu	Display Description	Standard Option	Advanced Option
Status * Advanced menu Status items displayed as scrolling information	Operating mode*	x	x
	Efficiency	x	x
	Load power (W)*	x	x
	Load power (VA)*	x	x
	Load amperage		x
	Load energy meter		x
	Battery charge state%	x	x
	Battery runtime*	x	x
	Battery voltage	x	x
	Battery temperature		x
	Input voltage and frequency*	x	x
	Output voltage and frequency*	x	x
	Last transfer reason*	x	x
	Last UPS self test result	x	x
	Outlet group status*		x
	NMC IP address (if applicable)		x
Control	UPS control		x
	Outlet Group control		x
Configuration	Language	x	x
	Output voltage setting (if applicable)		x
	Power quality	x	x
	Menu type	x	x
	Audible alarms	x	x
	Display mode	x	x
	Sensitivity		x
	Low voltage transfer points		x
	High voltage transfer points		x
	Low battery alert threshold		x
	Automatic self test interval		x
	Battery install date	x	x
	Reset energy meter		x
	Enter set-up wizard		x
	Perform firmware update (UPS output must be off)		x
	Reset to factory defaults	x	x
	Outlet group configuration		x
	NMC configuration (if applicable)		x
Test & Diagnostics	UPS self test	x	x
	UPS alarms test	x	x
	UPS calibration test	x	x

Main Menu	Display Description	Standard Option	Advanced Option
Logs	Last 10 transfer events (if applicable)		x
	Last 10 alert events (if applicable)		x
About	Model identification	x	x
	Part number	x	x
	Serial number	x	x
	UPS manufacture date	x	x
	Replace battery part number	x	x
	Battery install date	x	x
	Replace battery date	x	x
	UPS firmware revision	x	x
	NMC Information - part/serial/version numbers/manufacture date/MAC address/ firmware revision (if applicable)		x

Configuration

UPS Settings

Start up settings

At initial start up use the Setup Wizard to configure the following settings.

Function	Factory Default	Options	Description
Language	English	<ul style="list-style-type: none">• English• French• German• Spanish• Italian• Portuguese• Japanese	The language for the display interface. Language options will vary by model.
Output Voltage <i>230 Vac models only</i>	230 Vac	<ul style="list-style-type: none">• 220 Vac• 230 Vac• 240 Vac	UPS output must be off to configure this setting.
Local Power Quality	Good	<ul style="list-style-type: none">• Good• Fair• Poor	Select the desired utility input power quality. <ul style="list-style-type: none">• Good: The UPS will go on battery power more often to provide the cleanest power supply to connected equipment.• Fair: The UPS will tolerate some voltage fluctuations before switching to battery power.• Poor: The UPS will tolerate more voltage fluctuations and will go on battery power less often. The Power Quality setting will automatically change the high and low transfer points and the transfer sensitivity setting.
Menu Type	Standard	<ul style="list-style-type: none">• Standard• Advanced	The Advanced menus include all parameters. The Standard menus display a limited set of menus and options.
Date	UPS manufacture date + 90 days	mm-yyyy	At initial start up, enter the current date.

General settings

Configure these settings at any time, using the display interface or PowerChute™ software.

Function	Factory Default	Options	Description
High Transfer Point	100 Vac models: 108 Vac 120 Vac models: 127 Vac 230 Vac models: 253 Vac	100 Vac models: 108-114 Vac 120 Vac models: 127-136 Vac 230 Vac models: 242-276 Vac	To avoid unnecessary battery usage, the high and low transfer points can be adjusted. <ul style="list-style-type: none"> • Set the transfer point higher if the AC voltage is chronically high. • Set the transfer point lower if the AC voltage is chronically low.
Low Transfer Point	100 Vac models: 92 Vac 120 Vac models: 106 Vac 230 Vac models: 207 Vac	100 Vac models: 86-92 Vac 120 Vac models: 97-106 Vac 230 Vac models: 186-216 Vac	When the Power Quality setting is changed the high and low transfer points will automatically be adjusted. <i>230 Vac models only:</i> The transfer point options will change based on the output voltage setting.
Transfer Sensitivity	Normal	<ul style="list-style-type: none"> • Normal • Reduced • Low 	Set the sensitivity to a level that is appropriate for the connected equipment. <ul style="list-style-type: none"> • Normal: The UPS will go on battery power more often to provide the cleanest power supply to the connected equipment. • Reduced: The UPS will tolerate some voltage fluctuations before switching to battery power. • Low: The UPS will tolerate more voltage fluctuations and will go on battery power less often. When the Power Quality setting is changed the transfer sensitivity will automatically be adjusted.
Low Runtime Alert	120 sec	Value set in seconds	The UPS will emit an audible alarm when the remaining runtime has reached this level.
Date of Last Battery Replacement	Date set at factory	Reset this date when the battery module is replaced.	
Audible Alarm	On	<ul style="list-style-type: none"> • On • Off 	The UPS will mute all audible alarms if this is set to Off or when any of the display buttons are pressed.
Display Mode	Auto Dim	<ul style="list-style-type: none"> • Always On • Auto Dim • Auto Off 	<ul style="list-style-type: none"> • The display interface remains continuously illuminated. • The display interface illumination will diminish after two minutes of inactivity. • The display interface illumination will extinguish after two minutes of inactivity.

Function	Factory Default	Options	Description
Auto Self-Test Interval	On start up and 14 days after each self-test.	<ul style="list-style-type: none"> • Last test + 14 days • Last test + 7 days • Start up+ 14 days • Start up + 7 days • On start up only • Never 	<p>The interval at which the UPS will execute a self-test.</p> <p>The batteries must be charged to at least 70% capacity to perform a self-test.</p> <p>“Start up” on these menus refers to any time the UPS is turned on.</p>
Reset to Factory Default	No	<ul style="list-style-type: none"> • Yes • No 	Restore the UPS factory default settings.

Switched Outlet Groups

Overview

The UPS has two Switched Outlet Groups. Each can be configured to independently perform the following actions:

- Turn off: Disconnect from power immediately and restart only with a manual command.
- Turn on: Connect to power immediately.
- Shutdown: Disconnect power, and automatically reapply power when utility power becomes available.
- Reboot: Shut down and restart.
- Turn on or off in a specified sequence.
- Automatically turn off or shut down when various conditions occur.

Note: If the Switched Outlet Groups are not configured, all of the outlets on the unit will provide battery backup power.

Configure the Switched Outlet Groups

1. Connect equipment to the Switched Outlet Groups.
 - Nonessential equipment that should shut off quickly in the event of a power outage to conserve battery runtime can be added to a short power off delay.
 - If equipment has dependent peripherals that must restart or shut down in a specific order, such as an ethernet switch that must restart before a connected server, connect the devices to separate groups.
 - Equipment that needs to reboot independently from other equipment should be added to a separate group.
2. Use the Configuration menus to configure how the Switched Outlet Group will react in the event of a power outage.

Customize Switched Outlet Groups

Use the **Configuration** menu to change the Switched Outlet Group settings.

Function	Factory Default	Options	Description
Turn On Delay	0 sec	Set the value in seconds	The amount of time the UPS or Switched Outlet Group will wait between receiving the command to turn on and the actual startup.
Turn Off Delay	90 sec	Set the value in seconds	The amount of time that the UPS or Switched Outlet Group will wait between receiving the command to turn off and the actual shut down.
Reboot Duration	8 sec	Set the value in seconds	The amount of time that the UPS or Switched Outlet Group must remain off before it will restart.
Minimum Return Run Time	0 sec	Set the value in seconds	The amount of battery runtime that must be available before the UPS or Switched Outlet Group will turn on.
Load Shed Time On Battery	Disabled	<ul style="list-style-type: none"> • Enable • Disable 	When the unit switches to battery power, the UPS can disconnect power to the Switched Outlet Group to save runtime.
Load Shed Time On Battery	1800 sec	Set the value in seconds	The amount of time the Switched Outlet Group will continue function after the UPS begins operating on battery.
Load Shed Runtime Remain	Disabled	<ul style="list-style-type: none"> • Enable • Disable 	When the battery runtime falls below the specified value, the Switched Outlet Group will turn off.
Load Shed Runtime Remain	120 sec	Set the value in seconds	Remaining runtime required for the outlets to stay on.
Load Shed on Overload	Disabled	<ul style="list-style-type: none"> • Enable • Disable 	In the event of an overload (greater than 100% output), the Switched Outlet Group will immediately turn off to conserve power for critical loads. The Switched Outlet Group will only turn on again with a manual command.

Troubleshooting

Problem and Possible Cause	Solution
The UPS will not turn on or there is no output	
The UPS has not been turned on.	Press the ON button once to turn on the UPS.
The UPS is not connected to utility power.	Ensure that the power cable is securely connected to the unit and to the utility power supply.
The input circuit breaker has tripped.	Reduce the load to the UPS, disconnect nonessential equipment and reset the circuit breaker.
The unit shows very low or no input utility voltage.	Check the utility power supply to the UPS by plugging in a table lamp. If the light is very dim, check the utility voltage.
The UPS has detected an internal fault.	Do not attempt to use the UPS. Unplug the UPS and have it serviced immediately.
The UPS is operating on battery, while connected to utility power	
The input circuit breaker has tripped.	Reduce the load to the UPS, disconnect nonessential equipment and reset the circuit breaker.
There is very high, very low, or distorted input line voltage.	Move the UPS to a different outlet on a different circuit. Test the input voltage with the utility voltage display. If acceptable to the connected equipment, reduce the UPS sensitivity.
The UPS is beeping	
The UPS is in normal operation.	None. The UPS is protecting the connected equipment.
UPS does not provide expected backup time	
The UPS battery is weak due to a recent outage or is near the end of its service life.	Charge the battery. Batteries require recharging after extended outages and wear out faster when put into service often or when operated at elevated temperatures. If the battery is near the end of its service life, consider replacing the battery even if the replace battery indicator is not yet illuminated.
The UPS is experiencing an overload condition.	Check the UPS load display. Unplug unnecessary equipment, such as printers.
Display interface LEDs flash sequentially	
The UPS has been shut down remotely through software or an optional accessory card.	None. The UPS will restart automatically when AC power returns.
The Alert LED is illuminated, the UPS displays a message and emits a constant beeping	
The UPS has detected an internal fault.	Do not attempt to use the UPS. Turn the UPS off and have it serviced immediately.

Problem and Possible Cause	Solution
The replace battery LED is illuminated	
The battery has a weak charge.	Allow the battery to recharge for at least four hours. Then, perform a Self-Test. If the problem persists after recharging, replace the battery.
The replacement battery is not properly connected.	Ensure that the battery connector is securely connected.

Transport

1. Shut down and disconnect all connected equipment.
2. Disconnect the unit from mains power.
3. Disconnect all internal and external batteries (if applicable).
4. Follow the shipping instructions outlined in the *Service* section of this manual.

Service

If the unit requires service, do not return it to the dealer. Follow these steps:

1. Review the *Troubleshooting* section of the manual to eliminate common problems.
2. If the problem persists, contact APC by Schneider Electric Customer Support through the APC by Schneider Electric web site, **www.apc.com**.
 - a. Note the model number and serial number and the date of purchase. The model and serial numbers are located on the rear panel of the unit and are available through the LCD display on select models.
 - b. Call Customer Support. A technician will attempt to solve the problem over the phone. If this is not possible, the technician will issue a Returned Material Authorization Number (RMA#).
 - c. If the unit is under warranty, the repairs are free.
 - d. Service procedures and returns may vary internationally. For country specific instructions refer to the APC by Schneider Electric web site, **www.apc.com**.
3. Pack the unit properly to avoid damage in transit. Never use foam beads for packaging. Damage sustained in transit is not covered under warranty.
Note: Before shipping, always disconnect battery modules in a UPS or external battery pack. The disconnected internal batteries may remain inside the UPS or external battery pack.
4. Write the RMA# provided by Customer Support on the outside of the package.
5. Return the unit by insured, prepaid carrier to the address provided by Customer Support.

Limited Factory Warranty

Schneider Electric IT Corporation (SEIT), warrants its products to be free from defects in materials and workmanship for a period of two (2) years from the date of purchase. The SEIT obligation under this warranty is limited to repairing or replacing, at its own sole option, any such defective products. Repair or replacement of a defective product or parts thereof does not extend the original warranty period.

This warranty applies only to the original purchaser who must have properly registered the product within 10 days of purchase. Products may be registered online at warranty.apc.com.

SEIT shall not be liable under the warranty if its testing and examination disclose that the alleged defect in the product does not exist or was caused by end user or any third person misuse, negligence, improper installation, testing, operation or use of the product contrary to SEIT recommendations or specifications. Further, SEIT shall not be liable for defects resulting from: 1) unauthorized attempts to repair or modify the product, 2) incorrect or inadequate electrical voltage or connection, 3) inappropriate on site operation conditions, 4) Acts of God, 5) exposure to the elements, or 6) theft. In no event shall SEIT have any liability under this warranty for any product where the serial number has been altered, defaced, or removed.

EXCEPT AS SET FORTH ABOVE, THERE ARE NO WARRANTIES, EXPRESS OR IMPLIED, BY OPERATION OF LAW OR OTHERWISE, APPLICABLE TO PRODUCTS SOLD, SERVICED OR FURNISHED UNDER THIS AGREEMENT OR IN CONNECTION HEREWITH.

SEIT DISCLAIMS ALL IMPLIED WARRANTIES OF MERCHANTABILITY, SATISFACTION AND FITNESS FOR A PARTICULAR PURPOSE.

SEIT EXPRESS WARRANTIES WILL NOT BE ENLARGED, DIMINISHED, OR AFFECTED BY AND NO OBLIGATION OR LIABILITY WILL ARISE OUT OF, SEIT'S RENDERING OF TECHNICAL OR OTHER ADVICE OR SERVICE IN CONNECTION WITH THE PRODUCTS.

THE FOREGOING WARRANTIES AND REMEDIES ARE EXCLUSIVE AND IN LIEU OF ALL OTHER WARRANTIES AND REMEDIES. THE WARRANTIES SET FORTH ABOVE CONSTITUTE SEIT'S SOLE LIABILITY AND PURCHASER'S EXCLUSIVE REMEDY FOR ANY BREACH OF SUCH WARRANTIES. SEIT WARRANTIES EXTEND ONLY TO ORIGINAL PURCHASER AND ARE NOT EXTENDED TO ANY THIRD PARTIES.

IN NO EVENT SHALL SEIT, ITS OFFICERS, DIRECTORS, AFFILIATES OR EMPLOYEES BE LIABLE FOR ANY FORM OF INDIRECT, SPECIAL, CONSEQUENTIAL OR PUNITIVE DAMAGES, ARISING OUT OF THE USE, SERVICE OR INSTALLATION OF THE PRODUCTS, WHETHER SUCH DAMAGES ARISE IN CONTRACT OR TORT, IRRESPECTIVE OF FAULT, NEGLIGENCE OR STRICT LIABILITY OR WHETHER SEIT HAS BEEN ADVISED IN ADVANCE OF THE POSSIBILITY OF SUCH DAMAGES. SPECIFICALLY, SEIT IS NOT LIABLE FOR ANY COSTS, SUCH AS LOST PROFITS OR REVENUE, WHETHER DIRECT OR INDIRECT, LOSS OF EQUIPMENT, LOSS OF USE OF EQUIPMENT, LOSS OF SOFTWARE, LOSS OF DATA, COSTS OF SUBSTITUANTS, CLAIMS BY THIRD PARTIES, OR OTHERWISE.

NOTHING IN THIS LIMITED WARRANTY SHALL SEEK TO EXCLUDE OR LIMIT SEIT'S LIABILITY FOR DEATH OR PERSONAL INJURY RESULTING FROM ITS NEGLIGENCE OR ITS FRAUDULENT MISREPRESENTATION OF TO THE EXTENT THAT IT CANNOT BE EXCLUDED OR LIMITED BY APPLICABLE LAW.

To obtain service under warranty you must obtain a Returned Material Authorization (RMA) number from customer support. Customers with warranty claims issues may access the SEIT worldwide customer support network through the SEIT Web site: www.apc.com. Select your country from the country selection drop down menu. Open the Support tab at the top of the web page to obtain information for customer support in your region. Products must be returned with transportation charges prepaid and must be accompanied by a brief description of the problem encountered and proof of date and place of purchase.

APC by Schneider Electric Worldwide Customer Support

Customer support for this or any other APC by Schneider Electric product is available at no charge in any of the following ways:

- Visit the APC by Schneider Electric Web site to access documents in the APC by Schneider Electric Knowledge Base and to submit customer support requests.
 - **www.apc.com** (Corporate Headquarters)
Connect to localized APC by Schneider Electric Web sites for specific countries, each of which provides customer support information.
 - **www.apc.com/support/**
Global support searching APC by Schneider Electric Knowledge Base and using e-support.
- Contact the APC by Schneider Electric Customer Support Center by telephone or e-mail.
 - Local, country-specific centers: go to **www.apc.com/support/contact** for contact information.
 - For information on how to obtain local customer support, contact the APC by Schneider Electric representative or other distributors from whom you purchased your APC by Schneider Electric product.

© 2018 APC by Schneider Electric. APC, the APC logo, Smart-UPS and PowerChute are owned by Schneider Electric Industries S.A.S., or their affiliated companies. All other trademarks are property of their respective owners.