



**OPEN** Industry Standard, Flexible Architecture

**GREEN** Less Heat, Less Power Consumption

**STABLE** Robust Design, Quality Parts

Stable and  
Reliable Solution

**Server/Workstation**

Motherboard

EPYC3251D4I-2T  
EPYC3151D4I-2T  
EPYC3101D4I-2T  
EPYC3251D4I-NL  
EPYC3101D4I-NL

User Manual

English

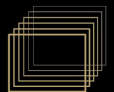

Version 1.1

Published November 2020

Copyright©2020 ASRock Rack Inc. All rights reserved.

## Copyright Notice:

No part of this documentation may be reproduced, transcribed, transmitted, or translated in any language, in any form or by any means, except duplication of documentation by the purchaser for backup purpose, without written consent of ASRock Rack Inc.

Products and corporate names appearing in this documentation may or may not be registered trademarks or copyrights of their respective companies, and are used only for identification or explanation and to the owners' benefit, without intent to infringe.

## Disclaimer:

Specifications and information contained in this documentation are furnished for informational use only and subject to change without notice, and should not be constructed as a commitment by ASRock Rack. ASRock Rack assumes no responsibility for any errors or omissions that may appear in this documentation.

With respect to the contents of this documentation, ASRock Rack does not provide warranty of any kind, either expressed or implied, including but not limited to the implied warranties or conditions of merchantability or fitness for a particular purpose.

In no event shall ASRock Rack, its directors, officers, employees, or agents be liable for any indirect, special, incidental, or consequential damages (including damages for loss of profits, loss of business, loss of data, interruption of business and the like), even if ASRock Rack has been advised of the possibility of such damages arising from any defect or error in the documentation or product.



This device complies with Part 15 of the FCC Rules. Operation is subject to the following two conditions:

- (1) this device may not cause harmful interference, and
- (2) this device must accept any interference received, including interference that may cause undesired operation.

## CALIFORNIA, USA ONLY

The Lithium battery adopted on this motherboard contains Perchlorate, a toxic substance controlled in Perchlorate Best Management Practices (BMP) regulations passed by the California Legislature. When you discard the Lithium battery in California, USA, please follow the related regulations in advance.

“Perchlorate Material-special handling may apply, see [www.dtsc.ca.gov/hazardouswaste/perchlorate](http://www.dtsc.ca.gov/hazardouswaste/perchlorate)”

**ASRock Rack's Website: [www.ASRockRack.com](http://www.ASRockRack.com)**

## Contact Information

If you need to contact ASRock Rack or want to know more about ASRock Rack, you're welcome to visit ASRock Rack's website at [www.ASRockRack.com](http://www.ASRockRack.com); or you may contact your dealer for further information.

### **ASRock Rack Incorporation**

6F., No.37, Sec. 2, Jhongyang S. Rd., Beitou District,

Taipei City 112, Taiwan (R.O.C.)

## Contents

<b>Chapter 1 Introduction</b>	<b>1</b>
1.1 Package Contents	1
1.2 Specifications	2
1.3 Unique Features	5
1.4 Motherboard Layout	6
1.5 Onboard LED Indicators	8
1.6 I/O Panel	9
1.7 Block Diagram	11
<b>Chapter 2 Installation</b>	<b>13</b>
2.1 Screw Holes	13
2.2 Pre-installation Precautions	13
2.3 Installation of Memory Modules (DIMM)	14
2.4 Expansion Slots (PCI Express Slots)	16
2.5 Onboard Headers and Connectors	17
2.6 AC-IN / DC-IN Power Connections	22
2.7 Unit Identification purpose LED/Switch	23
2.8 Driver Installation Guide	23
2.9 Dual LAN and Teaming Operation Guide	24
2.10 M.2_SSD (NGFF) Module Installation Guide (M2_1)	25
<b>Chapter 3 UEFI Setup Utility</b>	<b>27</b>
3.1 Introduction	27
3.1.1 UEFI Menu Bar	27
3.1.2 Navigation Keys	28

3.2	Main Screen	29
3.3	Advanced Screen	30
3.3.1	CPU Configuration	31
3.3.2	Chipset Configuration	32
3.3.3	Storage Configuration	34
3.3.4	ACPI Configuration	35
3.3.5	USB Configuration	36
3.3.6	Super IO Configuration	37
3.3.7	Serial Port Console Redirection	38
3.3.8	H/W Monitor	42
3.3.9	PSP Firmware Versions	44
3.3.10	AMD CBS	45
3.3.11	Instant Flash	46
3.4	Server Mgmt	47
3.4.1	System Event Log	48
3.4.2	BMC Network Configuration	49
3.5	Security	51
3.5.1	Key Management	52
3.6	Boot Screen	56
3.6.1	CSM Parameters	58
3.7	Event Logs	60
3.8	Exit Screen	62
	<b>Chapter 4 Software Support</b>	<b>63</b>
4.1	Install Operating System	63

4.2	Support CD Information	63
4.2.1	Running The Support CD	63
4.2.2	Drivers Menu	63
4.2.3	Utilities Menu	63
4.2.4	Contact Information	63
	<b>Chapter 5 Troubleshooting</b>	<b>64</b>
5.1	Troubleshooting Procedures	64
5.2	Technical Support Procedures	66
5.3	Returning Merchandise for Service	66

# Chapter 1 Introduction

Thank you for purchasing ASRock Rack **EPYC3251D4I-2T / EPYC3151D4I-2T / EPYC3101D4I-2T / EPYC3251D4I-NL / EPYC3101D4I-NL** motherboard, a reliable motherboard produced under ASRock Rack's consistently stringent quality control. It delivers excellent performance with robust design conforming to ASRock Rack's commitment to quality and endurance.

In this manual, chapter 1 and 2 contains introduction of the motherboard and step-by-step guide to the hardware installation. Chapter 3 and 4 contains the configuration guide to BIOS setup and information of the Support CD.



*Because the motherboard specifications and the BIOS software might be updated, the content of this manual will be subject to change without notice. In case any modifications of this manual occur, the updated version will be available on ASRock Rack website without further notice. You may find the latest memory and CPU support lists on ASRock Rack website as well. ASRock Rack's Website: [www.ASRockRack.com](http://www.ASRockRack.com)*

*If you require technical support related to this motherboard, please visit our website for specific information about the model you are using.  
<http://www.asrockrack.com/support/>*

## 1.1 Package Contents

- ASRock Rack EPYC3251D4I-2T / EPYC3151D4I-2T / EPYC3101D4I-2T / EPYC3251D4I-NL / EPYC3101D4I-NL Motherboard  
(Mini-ITX Form Factor: 6.7-in x 6.7-in, 17.02 cm x 17.02 cm)
- Quick Installation Guide
- 1 x Oculink to 4 SATA Cable (60cm) (Optional)
- 1 x SATA3 Cable (60cm)
- 1 x SATA Power Cable (80cm)
- 1 x ATX 4P to 24P Power Cable (8cm)
- 1 x I/O Shield
- 1 x Screw for M.2 Socket



*If any items are missing or appear damaged, contact your authorized dealer.*

## 1.2 Specifications

EPYC3251D4I-2T / EPYC3151D4I-2T / EPYC3101D4I-2T / EPYC3251D4I-NL / EPYC3101D4I-NL	
<b>MB Physical Status</b>	
Form Factor	Mini-ITX
Dimension	6.7" x 6.7" (17.02 cm x 17.02 cm)
<b>Processor System</b>	
CPU	Support AMD EPYC™ Embedded 3000 Series Processors
Chipset	Soc
<b>System Memory</b>	
Capacity	- 4 x 288-pin DDR4 SDRAM DIMM slots - Support up to 256GB DDR4 ECC/UDIMM, RDIMM
Type	- Dual Channel DDR4 memory technology - Support DDR4 ECC/UDIMM, RDIMM
Voltage	1.2V
DIMM Size per DIMM	- ECC/UDIMM: 64GB, 32GB, 16GB, 8GB, 4GB - RDIMM: 128GB, 64GB, 32GB, 16GB, 8GB, 4GB
DIMM Frequency	- ECC/UDIMM: 2133/2400/2666 MHz - RDIMM: 2133/2400/2666 MHz *the max speed may vary based on SoC SKU
<b>Expansion Slot</b>	
PCIe 3.0 x 16	SLOT7: Gen3 x16 link
<b>Storage</b>	
SATA Controller	AMD Built-in Storage: 6 x SATAIII 6.0 Gb/s (4 x SATA from OCulink, 2 x SATAIII 6.0 Gb/s)
M.2 Slot	1 (2280/22110, supports PCIe 3.0 x4 and SATA3 shared with SATA_4 port)
<b>Ethernet</b>	
Interface	<b>EPYC3251D4I-2T / EPYC3151D4I-2T / EPYC3101D4I-2T:</b> 10000/1000 Mbps  <b>EPYC3251D4I-NL / EPYC3101D4I-NL:</b> N/A
LAN Controller	<b>EPYC3251D4I-2T / EPYC3151D4I-2T / EPYC3101D4I-2T:</b> - 2 x RJ45 10GLAN by Intel® X550-AT2 - Supports Wake-On-LAN - Supports Energy Efficient Ethernet 802.3az - Supports Dual LAN with Teaming function - Supports PXE - LAN1 Supports NCSI  <b>EPYC3251D4I-NL / EPYC3101D4I-NL:</b> N/A



Management	
BMC Controller	ASPEED AST2500 : IPMI (Intelligent Platform Management Interface) 2.0 with ikvm and vMedia support
IPMI Dedicated GLAN	1 x Realtek RTL8211E for dedicated management LAN
Features	- Watch Dog - NMI
Graphics	
Controller	ASPEED AST2500
Rear Panel I/O	
VGA Port	D-sub x 1
Lan Port	<b>EPYC3251D4I-2T / EPYC3151D4I-2T / EPYC3101D4I-2T:</b> - 2 x 10GLAN RJ45(by Intel® X550-AT2 )  <b>EPYC3251D4I-NL / EPYC3101D4I-NL:</b> N/A  - 1 x RJ45 Dedicated IPMI LAN port - LAN Ports with LED (ACT/LINK LED and SPEED LED)
UID Button	1
USB 3.2 Gen1	2
Internal Connector	
COM Header	1
M.2	1 x M-Key (PCIe3.0 x4 or SATAIII 6.0 Gb/s); Supports 22110/2280 form factor
Front Panel	1
Auxiliary Panel Header	1 (include chassis intrusion, 2 front LAN LED, System LED)
TPM Header	1
IPMB Header	1
PSU_SMB1	1
USB 3.2 Gen1 Header	1 (supports 2 USB 3.2 Gen1 ports)
Fan Header	1 x CPU Fan, 2 x System Fans (1 front, 1 rear)
ATX Power	1 x (4-pin) + 1 x (8-pin) support 12V DC-IN
SATA Power	1 (for DC-IN mode) <i>*Caution: Misconnection may permanently damage the motherboard.</i>
ClearCMOS	1 (short pad)
FanFail LED	3
SATA SGPIO	1
System BIOS	
BIOS Type	16MB AMI UEFI Legal BIOS

BIOS Features	<ul style="list-style-type: none"> <li>- Plug and Play (PnP)</li> <li>- ACPI 2.0 Compliance Wake Up Events</li> <li>- SMBIOS 2.8 Support</li> <li>- ASRockRack Instant Flash</li> </ul>
<b>Hardware Monitor</b>	
Temperature	<ul style="list-style-type: none"> <li>- CPU/DDR/LAN/Storage Temperature Sensing</li> <li>- MB/Card Side Temperature Sensing</li> </ul>
Fan	<ul style="list-style-type: none"> <li>- CPU/Rear/Front Fan Tachometer</li> <li>- CPU Quiet Fan (Allow Chassis Fan Speed Auto-Adjust by CPU Temperature)</li> <li>- CPU/Rear/Front Fan Multi-Speed Control</li> </ul>
Voltage	Voltage Monitoring: +12V, +5V, +3.3V, CPU Vcore, DRAM, +1.1V,+1.0V, +BAT, 3VSB, 5VSB
<b>Support OS</b>	
OS	<p>Microsoft® Windows*:</p> <ul style="list-style-type: none"> <li>- Server 2019 (64 bit)</li> </ul> <p>Linux:</p> <ul style="list-style-type: none"> <li>- RedHat Enterprise Linux Server 7.4 (64 bit) / 7.6 (64 bit)</li> <li>- CentOS 7.4 (64 bit) / 7.6 (64 bit)</li> <li>- Ubuntu 18.04 (64 bit)</li> </ul> <p><i>* Please refer to our website for the latest OS support list.</i></p>
<b>Environment</b>	
Temperature	<p>Operation temperature: 10°C ~ 35°C / Non operation temperature: -40°C ~ 70°C</p> <p><i>* Install a CPU Fan when the airflow through the heatsink is below 2CFM.</i></p>

\* For detailed product information, please visit our website: <http://www.asrockrack.com>



*This motherboard supports Wake from on Board LAN. To use this function, please make sure that the "Wake on Magic Packet from power off state" is enabled in Device Manager > Intel® Ethernet Connection > Power Management. And the "PCI Devices Power On" is enabled in UEFI SETUP UTILITY > Advanced > ACPI Configuration. After that, onboard LAN1&2 can wake up S5 under OS.*



*If you install Intel® LAN utility, this motherboard may fail Windows® Hardware Quality Lab (WHQL) certification tests. If you install the drivers only, it will pass the WHQL tests.*

## 1.3 Unique Features

ASRock Instant Flash is a BIOS flash utility embedded in Flash ROM. This convenient BIOS update tool allows you to update system BIOS without entering operating systems first like MS-DOS or Windows<sup>®</sup>. With this utility, you can press the <F6> key during the POST or the <F2> key to enter into the BIOS setup menu to access ASRock Rack Instant Flash. Just launch this tool and save the new BIOS file to your USB flash drive, floppy disk or hard drive, then you can update your BIOS only in a few clicks without preparing an additional floppy diskette or other complicated flash utility. Please be noted that the USB flash drive or hard drive must use FAT32/16/12 file system.

# 1.4 Motherboard Layout

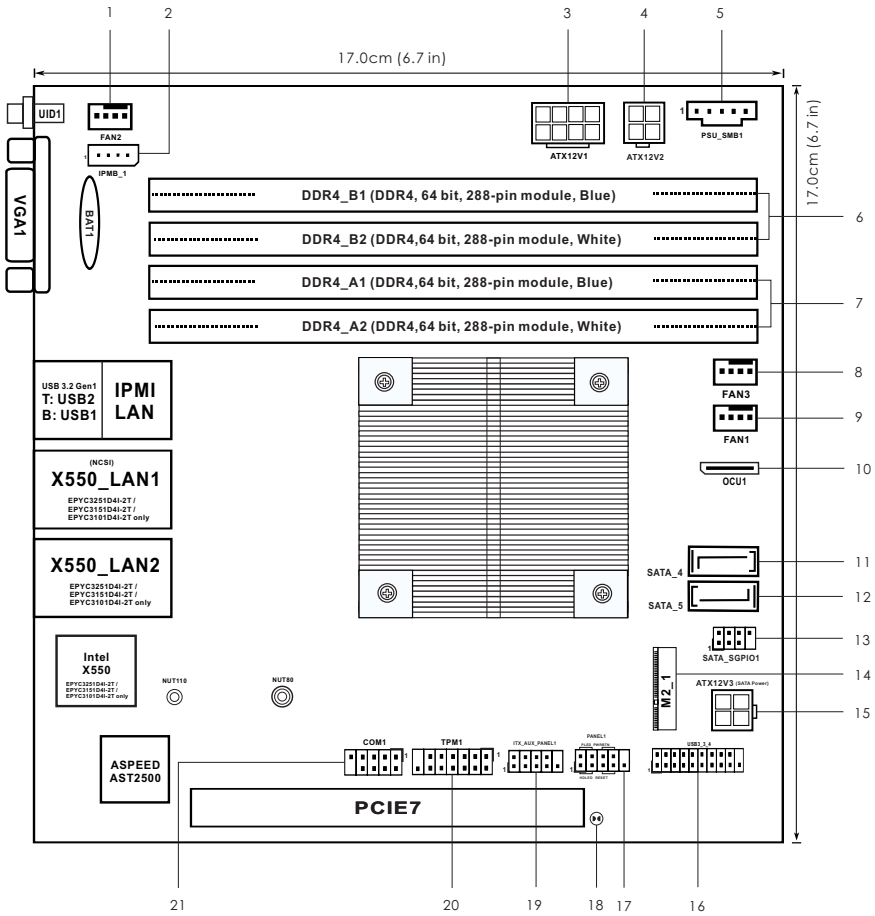

No.	Description
1	Rear Fan Connector (FAN2)
2	Intelligent Platform Management Bus header (IPMB_1)
3	ATX 12V Power Connector (ATX12V1)
4	ATX 4-PIN Power Connector (ATX12V2 (ATX 24pin-to-4pin))***
5	PSU SMBus (PSU_SMB1)
6	2 x 288-pin DDR4 DIMM Slots (DDR4_B1, DDR4_B2)*
7	2 x 288-pin DDR4 DIMM Slots (DDR4_A1, DDR4_A2)*
8	Front Fan Connector (FAN3)
9	CPU Fan Connector (FAN1)
10	OCuLink x4 Connector (OCU1)
11	SATA3 Connector (SATA_4)**
12	SATA3 Connector (SATA_5)
13	SATA SGPIO Connector (SATA_SGPIO1)
14	M.2 Socket (M2_1) (Type 2280/22110)**
15	SATA Power Connector (ATX12V3)***
16	USB 3.2 Gen1 Header (USB3_3_4)
17	System Panel Header (PANEL1)
18	Clear CMOS Pad (CLRMOSE1)
19	Auxiliary Panel Header (ITX_AUX_PANEL1)
20	TPM Header (TPM1)
21	COM Port Header (COM1)

\*For DIMM installation and configuration instructions, please see p.14 (Installation of Memory Modules (DIMM)) for more details.

\*\* If M2\_1 is occupied by a SATA-type M.2 device, SATA\_4 will be disabled.

\*\*\*Caution: Misconnection between the ATX12V2 and the ATX12V3 connectors may permanently damage the motherboard.

## 1.5 Onboard LED Indicators

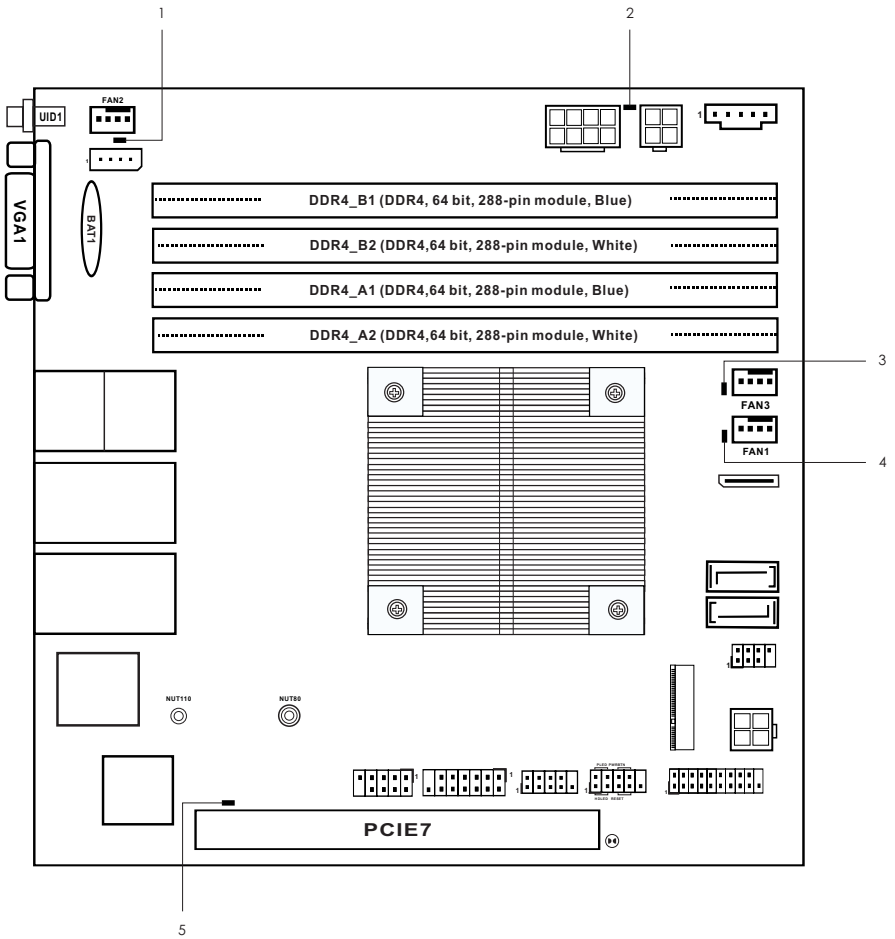

No.	Item	Status	Description
1	LED_FAN2	Amber	FAN2 failed
2	SB_PWR1	Green	STB PWR ready
3	LED_FAN3	Amber	FAN3 failed
4	LED_FAN1	Amber	FAN1 failed
5	BMC_LED1	Green	BMC heartbeat LED

## 1.6 I/O Panel

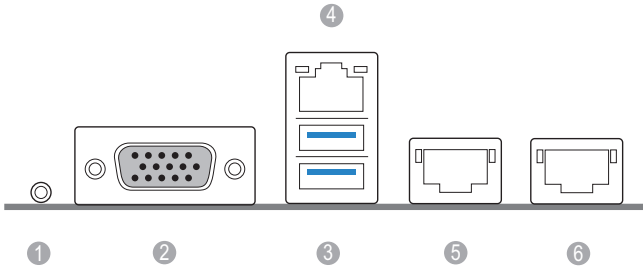

No.	Description	No.	Description
1	UID Switch/LED (UID1)	4	Dedicated IPMI LAN Port*
2	VGA Port (VGA1)	5	10G LAN RJ-45 Port (LAN1)** EPYC3251D4I-NL / EPYC3101D4I-NL: N/A
3	USB 3.2 Gen1 Ports (USB3_1_2)	6	10G LAN RJ-45 Port (LAN2)** EPYC3251D4I-2T / EPYC3151D4I-2T / EPYC3101D4I-2T: N/A

### LAN Port LED Indications

\*There are two LED next to the LAN port. Please refer to the table below for the LAN port LED indications.

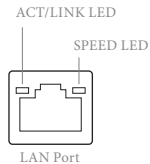

### Dedicated IPMI LAN Port LED Indications

Activity / Link LED		Speed LED	
Status	Description	Status	Description
Off	No Link	Off	10M bps connection or no link
Blinking Yellow	Data Activity	Yellow	100M bps connection
On	Link	Green	1G bps connection

\*\*There are two LEDs on each LAN port. Please refer to the table below for the LAN port LED indications.

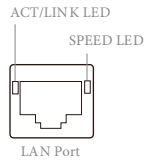

### 10G LAN Port (LAN1, LAN2) LED Indications

Activity / Link LED		Speed LED	
Status	Description	Status	Description
Off	No Link	Off	100Mbps connection or no link
Blinking Green	Data Activity	Yellow	1Gbps connection
On	Link	Green	10Gbps connection



## 1.7 Block Diagram

EPYC3251D4I-2T / EPYC3151D4I-2T / EPYC3101D4I-2T

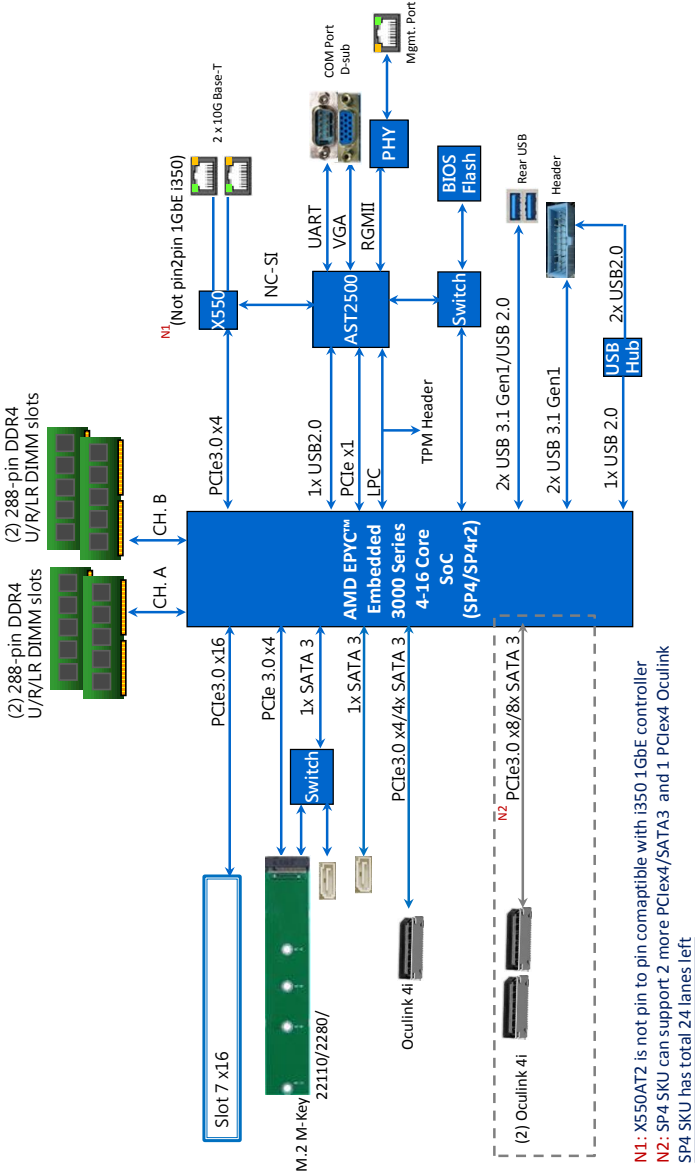

EPYC3251D4I-NL / EPYC3101D4I-NL

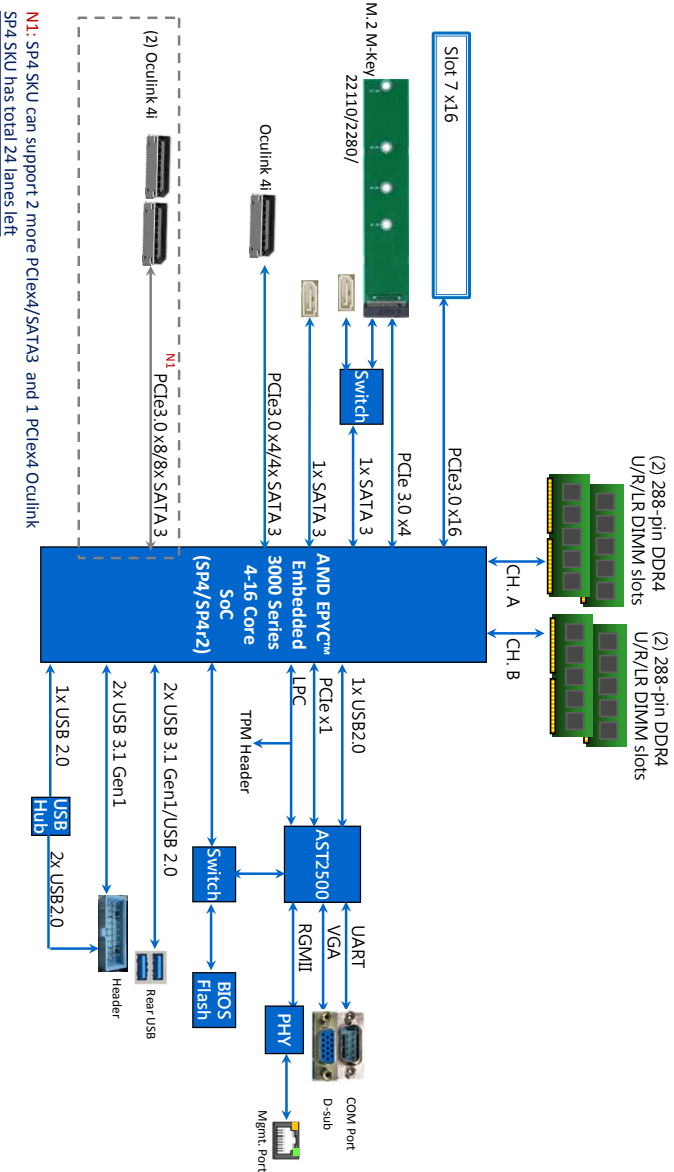

## Chapter 2 Installation

This is a Mini-ITX form factor (6.7" x 6.7", 17.0 cm x 17.0 cm) motherboard. Before you install the motherboard, study the configuration of your chassis to ensure that the motherboard fits into it.



*Make sure to unplug the power cord before installing or removing the motherboard. Failure to do so may cause physical injuries to you and damages to motherboard components.*

### 2.1 Screw Holes

Place screws into the holes indicated by circles to secure the motherboard to the chassis.



*Do not over-tighten the screws! Doing so may damage the motherboard.*

### 2.2 Pre-installation Precautions

Take note of the following precautions before you install motherboard components or change any motherboard settings.

1. Unplug the power cord from the wall socket before touching any components.
2. To avoid damaging the motherboard's components due to static electricity, NEVER place your motherboard directly on the carpet or the like. Also remember to use a grounded wrist strap or touch a safety grounded object before you handle the components.
3. Hold components by the edges and do not touch the ICs.
4. Whenever you uninstall any component, place it on a grounded anti-static pad or in the bag that comes with the component.
5. When placing screws into the screw holes to secure the motherboard to the chassis, please do not over-tighten the screws! Doing so may damage the motherboard.



*Before you install or remove any component, ensure that the power is switched off or the power cord is detached from the power supply. Failure to do so may cause severe damage to the motherboard, peripherals, and/or components.*

## 2.3 Installation of Memory Modules (DIMM)

This motherboard provides four 288-pin DDR4 (Double Data Rate 4) DIMM slots, and supports Dual Channel Memory Technology.



1. For dual channel configuration, you always need to install identical (the same brand, speed, size and chip-type) DDR4 DIMM pairs.
2. It is not allowed to install a DDR, DDR2 or DDR3 memory module into a DDR4 slot; otherwise, this motherboard and DIMM may be damaged.
3. Please install the memory module on CH0\_A1 for the first priority.
4. To activate Dual Channel Memory Technology, please follow the "Dual Channel Memory Configuration" table below.

### Dual Channel Memory Configuration

Priority	DDR4_A1 (Blue)	DDR4_A2 (White)	DDR4_B1 (Blue)	DDR4_B2 (White)
1	Populated		Populated	
2	Populated	Populated	Populated	Populated

*\*Since installing three memory modules is NOT supported on this motherboard, we suggest not using this configuration.*



*The DIMM only fits in one correct orientation. It will cause permanent damage to the motherboard and the DIMM if you force the DIMM into the slot at incorrect orientation.*

1

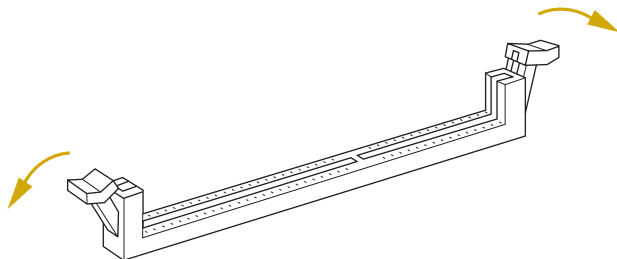

2

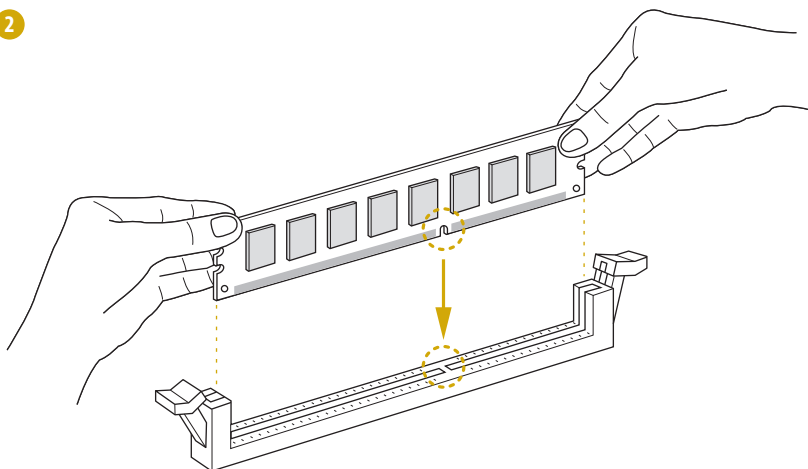

3

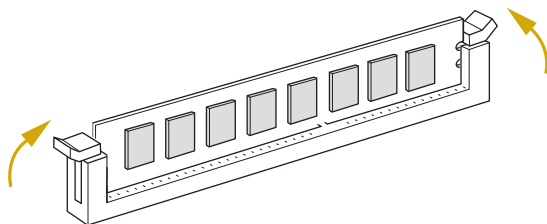

## 2.4 Expansion Slots (PCI Express Slots)

There is 1 PCI Express slots on this motherboard.

### PCIe slot:

PCIe7 (PCIe 3.0 x16 slot) is used for PCI Express x16 lane width cards.

### Installing an expansion card

- Step 1. Before installing an expansion card, please make sure that the power supply is switched off or the power cord is unplugged. Please read the documentation of the expansion card and make necessary hardware settings for the card before you start the installation.
- Step 2. Remove the system unit cover (if your motherboard is already installed in a chassis).
- Step 3. Remove the bracket facing the slot that you intend to use. Keep the screws for later use.
- Step 4. Align the card connector with the slot and press firmly until the card is completely seated on the slot.
- Step 5. Fasten the card to the chassis with screws.
- Step 6. Replace the system cover.

## 2.5 Onboard Headers and Connectors



Onboard headers and connectors are **NOT** jumpers. Do **NOT** place jumper caps over these headers and connectors. Placing jumper caps over the headers and connectors will cause permanent damage to the motherboard.

System Panel Header  
(9-pin PANEL1)  
(see p.6, No. 17)

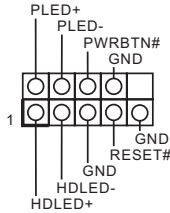

Connect the power switch, reset switch and system status indicator on the chassis to this header according to the pin assignments. Particularly note the positive and negative pins before connecting the cables.



**PWRBTN (Power Switch):**

Connect to the power switch on the chassis front panel. You may configure the way to turn off your system using the power switch.

**RESET (Reset Switch):**

Connect to the reset switch on the chassis front panel. Press the reset switch to restart the computer if the computer freezes and fails to perform a normal restart.

**PLED (System Power LED):**

Connect to the power status indicator on the chassis front panel. The LED is on when the system is operating. The LED is off when the system is in S4 sleep state or powered off (S5).

**HDLED (Hard Drive Activity LED):**

Connect to the hard drive activity LED on the chassis front panel. The LED is on when the hard drive is reading or writing data.

The front panel design may differ by chassis. A front panel module mainly consists of power switch, reset switch, power LED, hard drive activity LED, speaker and etc. When connecting your chassis front panel module to this header, make sure the wire assignments and the pin assignments are matched correctly.

Auxiliary Panel Header  
(9-pin ITX\_AUX\_PAN-  
EL1)  
(see p.6, No. 19)

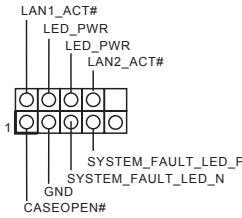

This header supports multiple functions on the front panel, including front panel SMB, internet status indicator.

Serial ATA3 Connectors  
(SATA\_4)  
(see p.6, No. 11)  
(SATA\_5)  
(see p.6, No. 12)

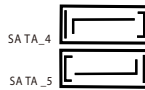

These two SATA3 connectors support SATA data cables for internal storage devices with up to 6.0 Gb/s data transfer rate.

*\* If M2\_1 is occupied by a SATA-type M.2 device, SATA\_4 will be disabled.*

OCuLink Connector  
(OCU1)  
(see p.6, No. 10)



Please connect a PCIE SSD to the connector.

USB 3.2 Gen1 Header  
(19-pin USB3\_3\_4)  
(see p.6, No. 16)

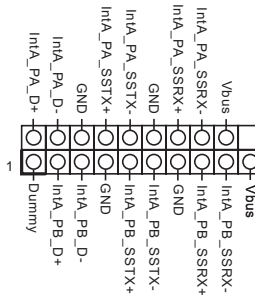

Besides two default USB 3.2 Gen1 ports on the I/O panel, there is one USB 3.2 Gen1 header on this motherboard. This USB 3.2 Gen1 header can support two USB 3.2 Gen1 ports.

TPM Header  
(13-pin TPM1)  
(see p.6, No. 20)

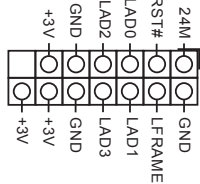

This connector supports Trusted Platform Module (TPM) system, which can securely store keys, digital certificates, passwords, and data. A TPM system also helps enhance network security, protects digital identities, and ensures platform integrity.



PSU SMBus  
(PSU\_SMB1)  
(see p.6, No. 5)

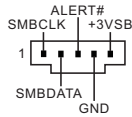

PSU SMBus monitors the status of the power supply, fan and system temperature.

Serial General Purpose  
Input/Output Header  
(7-pin SATA\_SGPIO1)  
(see p.6, No. 13)

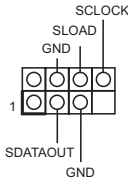

The header supports Serial Link interface for onboard SATA connections.

Front and Rear  
Fan Connectors  
(4-pin FAN2)  
(see p.6, No. 1)  
(4-pin FAN3)  
(see p.6, No. 8)

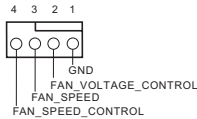

Please connect the fan cables to the fan connectors and match the black wire to the ground pin. All fans supports Fan Control.

CPU Fan Connectors  
(4-pin FAN1)  
(see p.6, No. 9)

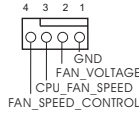

Please connect the CPU fan cable to the connector and match the black wire to the ground pin.

Though this motherboard provides a 4-Pin CPU fan (Quiet Fan) connector, 3-Pin CPU fans can still work successfully even without the fan speed control function. If you plan to connect a 3-Pin CPU fan to the CPU fan connector on this motherboard, please connect it to Pin 1-3.

*\*For more details, please refer to the Cooler QVL list on the ASRock Rack website.*

---

ATX 4-PIN Power Connector  
(4-pin ATX12V2  
(ATX 24pin-to-4pin))  
(see p.6, No. 4)

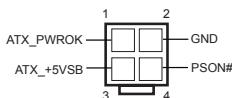

The motherboard provides one 4-pin power/signal connector which is a required input for ATX power source.

When using ATX power, it is necessary to use a 24pin-to-4pin power cable to connect between the 24pin power connector of PSU and the ATX12V2 connector on the motherboard for power supply and signal communication.

For DC-IN 12V application, it is not necessary to use this ATX 4-PIN power connector.

*\*Caution: Misconnection between the ATX12V2 and the ATX12V3 connectors may permanently damage the motherboard.*

---

ATX 12V Power Connector  
(8-pin ATX12V1)  
(see p.6, No. 3)

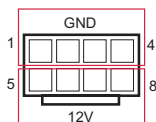

The motherboard provides one 8-pin 12V power connector which is a required input for either DC-IN 12V or ATX +12V power source.

When using ATX power, it is necessary to use a 24pin-to-4pin power cable to connect between the 24pin power connector of PSU and the ATX12V2 connector on the motherboard for power supply and signal communication.

---

SATA Power Connector  
(DC-IN mode)  
(4-pin ATX12V3)  
(see p.6, No. 15)

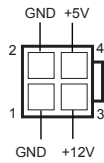

Please use a SATA power cable to connect this SATA Power Connector and your SATA HDD for supplying power from the motherboard, when using DC-IN mode without SATA power supply.

*\*Caution: Misconnection between the ATX12V2 and the ATX12V3 connectors may permanently damage the motherboard.*

Intelligent Platform  
Management Bus header  
(4-pin IPMB\_1)  
(see p.6, No. 2)

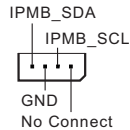

This 4-pin connector is used to provide a cabled baseboard or front panel connection for value added features and 3rd-party add-in cards, such as Emergency Management cards, that provide management features using the IPMB.

Serial Port Header  
(9-pin COM1)  
(see p.6, No. 21)

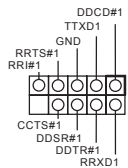

This COM header supports a serial port module.

Clear CMOS Pads  
(CLRMOS1)  
(see p.6, No. 18)



This allows you to clear the data in CMOS. To clear CMOS, take out the CMOS battery and short the Clear CMOS Pad.

## 2.6 ATX PSU / DC-IN Power Connections

This motherboard supports both +12V DC and ATX power input. Please refer to the table below for the required connections between the motherboard and the power supply.

Connector	DC-IN	ATX PSU
12V 8pin	O	O
ATX 4pin	X	O <i>(with the bundled ATX 24pin-to-4pin converter cable)</i>

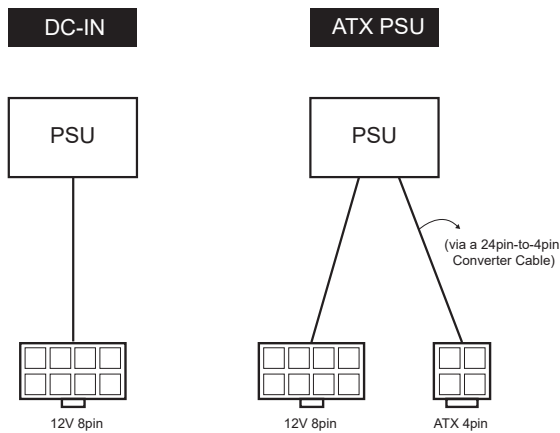

The following diagram illustrates how to connect the bundled ATX 24pin-to-4pin converter cable.

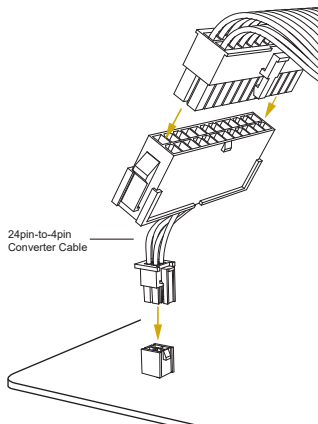

## 2.7 Unit Identification purpose LED/Switch

With the UID button, You are able to locate the server you're working on from behind a rack of servers.

Unit Identification  
purpose LED/Switch  
(UID1)



When the UID button on the front or rear panel is pressed, the front/rear UID blue LED indicator will be turned on. Press the UID button again to turn off the indicator.

## 2.8 Driver Installation Guide

To install the drivers to your system, please insert the support CD to your optical drive first. Then, the drivers compatible to your system can be auto-detected and listed on the support CD driver page. Please follow the order from top to bottom to install those required drivers. Therefore, the drivers you install can work properly.

## 2.9 Dual LAN and Teaming Operation Guide

Dual LAN with Teaming enabled on this motherboard allows two single connections to act as one single connection for twice the transmission bandwidth, making data transmission more effective and improving the quality of transmission of distant images. Fault tolerance on the dual LAN network prevents network downtime by transferring the workload from a failed port to a working port.



*The speed of transmission is subject to the actual network environment or status even with Teaming enabled.*

Before setting up Teaming, please make sure whether your Switch (or Router) supports Teaming (IEEE 802.3ad Link Aggregation). You can specify a preferred adapter in Intel PROSet. Under normal conditions, the Primary adapter handles all non-TCP/IP traffic. The Secondary adapter will receive fallback traffic if the primary fails. If the Preferred Primary adapter fails, but is later restored to an active status, control is automatically switched back to the Preferred Primary adapter.

### **Step 1**

From **Device Manager**, open the properties of a team.

### **Step 2**

Click the **Settings** tab.

### **Step 3**

Click the **Modify Team** button.

### **Step 4**

Select the adapter you want to be the primary adapter and click the **Set Primary** button.

If you do not specify a preferred primary adapter, the software will choose an adapter of the highest capability (model and speed) to act as the default primary. If a failover occurs, another adapter becomes the primary. The adapter will, however, rejoin the team as a non-primary.

## 2.10 M.2\_SSD (NGFF) Module Installation Guide (M2\_1)

The M.2, also known as the Next Generation Form Factor (NGFF), is a small size and versatile card edge connector that aims to replace mPCIe and mSATA. The Ultra M.2 Socket supports a M.2 SATA3 6.0 Gb/s module or a M.2 PCI Express module up to Gen3 x4 (32Gb/s).

*\* If M2\_1 is occupied by a SATA-type M.2 device, SATA\_4 will be disabled.*

### Installing the M.2\_SSD (NGFF) Module

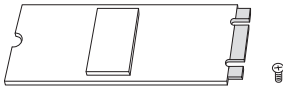

#### Step 1

Prepare a M.2\_SSD (NGFF) module and the screw.

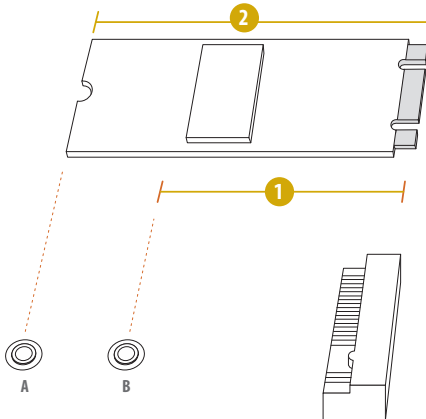

#### Step 2

Depending on the PCB type and length of your M.2\_SSD (NGFF) module, find the corresponding nut location to be used.

No.	1	2
Nut Location	B	A
PCB Length	8cm	11cm
Module Type	Type2280	Type 22110

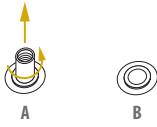

### Step 3

Move the standoff based on the module type and length. Skip Step 3 and 4 and go straight to Step 5 if you are going to use the default nut. Otherwise, release the standoff by hand.

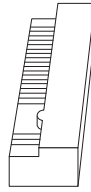

### Step 4

Peel off the yellow protective film on the nut to be used. Hand tighten the standoff into the desired nut location on the motherboard.

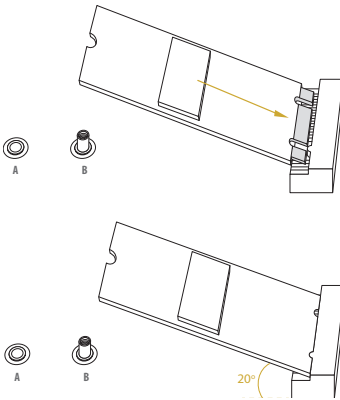
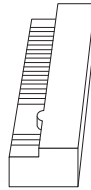

### Step 5

Align and gently insert the M.2 (NGFF) SSD module into the M.2 slot. Please be aware that the M.2 (NGFF) SSD module only fits in one orientation.

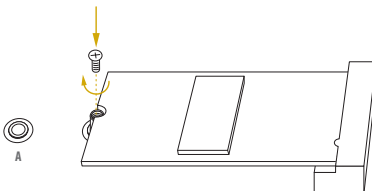

### Step 6

Tighten the screw with a screwdriver to secure the module into place. Please do not overtighten the screw as this might damage the module.



## Chapter 3 UEFI Setup Utility

### 3.1 Introduction

This section explains how to use the UEFI SETUP UTILITY to configure your system. The UEFI chip on the motherboard stores the UEFI SETUP UTILITY. You may run the UEFI SETUP UTILITY when you start up the computer. Please press <F2> or <Del> during the Power-On-Self-Test (POST) to enter the UEFI SETUP UTILITY; otherwise, POST will continue with its test routines.

If you wish to enter the UEFI SETUP UTILITY after POST, restart the system by pressing <Ctrl> + <Alt> + <Delete>, or by pressing the reset button on the system chassis. You may also restart by turning the system off and then back on.



*Because the UEFI software is constantly being updated, the following UEFI setup screens and descriptions are for reference purpose only, and they may not exactly match what you see on your screen.*

#### 3.1.1 UEFI Menu Bar

The top of the screen has a menu bar with the following selections:

Item	Description
Main	To set up the system time/date information
Advanced	To set up the advanced UEFI features
Server Mgmt	To manage the server
Security	To set up the security features
Boot	To set up the default system device to locate and load the Operating System
Event Logs	For event log configuration
Exit	To exit the current screen or the UEFI SETUP UTILITY

Use <←→> key or <→> key to choose among the selections on the menu bar, and then press <Enter> to get into the sub screen.

### 3.1.2 Navigation Keys

Please check the following table for the function description of each navigation key.

Navigation Key(s)	Function Description
← / →	Moves cursor left or right to select Screens
↑ / ↓	Moves cursor up or down to select items
+ / -	To change option for the selected items
<Tab>	Switch to next function
<Enter>	To bring up the selected screen
<PGUP>	Go to the previous page
<PGDN>	Go to the next page
<HOME>	Go to the top of the screen
<END>	Go to the bottom of the screen
<F1>	To display the General Help Screen
<F7>	Discard changes and exit the UEFI SETUP UTILITY
<F9>	Load optimal default values for all the settings
<F10>	Save changes and exit the UEFI SETUP UTILITY
<F12>	Print screen
<ESC>	Jump to the Exit Screen or exit the current screen

## 3.2 Main Screen

Once you enter the UEFI SETUP UTILITY, the Main screen will appear and display the system overview. The Main screen provides system overview information and allows you to set the system time and date.

```

Adtio Setup Utility - Copyright (C) 2019 American Megatrends, Inc.
Main Advanced Server Mgmt Security Boot Event Logs Exit

UEFI Version      : EPYC3251D4I-2T P1.00
BMC Version       : 0.09.00
Processor Type    : AMD EPYC 3251 8-Core Processor

Processor Speed   : 2514MHz
Microcode Update : 800F12/8001230
L1 Instruction Cache : 64KB
L1 Data Cache Size : 32KB
L2 Cache Size     : 512KB
L3 Cache per Socket : 16MB

Total Memory      : 8GB
DDR4_A1           : 8GB ECCDIMM (DDR4-2666)
DDR4_A2           : None
DDR4_B1           : None
DDR4_B2           : None

System Date       [Tue 06/04/2019]
System Time       [22:42:06]

Set the Date. Use Tab to
switch between Date elements.
Default Ranges:
Year: 2005-2099
Months: 1-12
Days: dependent on month

+/-: Change Option
F1: General Help
F7: Discard Changes
F9: Load UEFI Defaults
F10: Save and Exit
ESC: Exit

Version 2.10.1264. Copyright (C) 2019 American Megatrends, Inc.
  
```

### 3.3 Advanced Screen

In this section, you may set the configurations for the following items: CPU Configuration, Chipset Configuration, Storage Configuration, ACPI Configuration, USB Configuration, Super IO Configuration, Serial Port Console Redirection, H/W Monitor, PSP Firmware Versions, AMD CBS and Instant Flash.

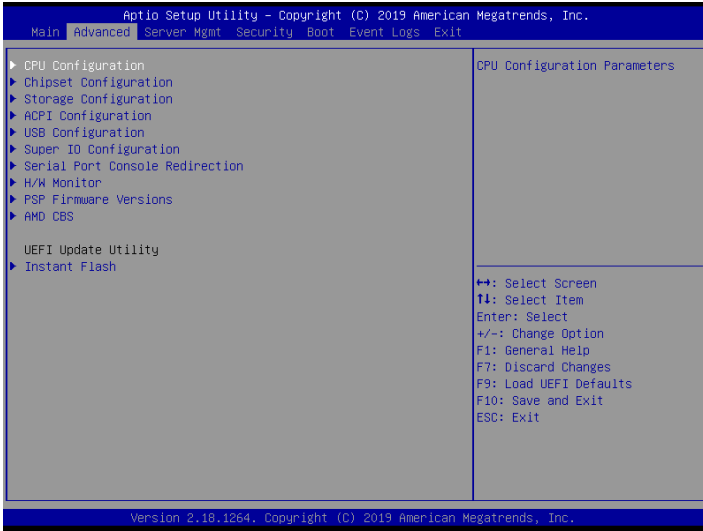

*Setting wrong values in this section may cause the system to malfunction.*

### 3.3.1 CPU Configuration

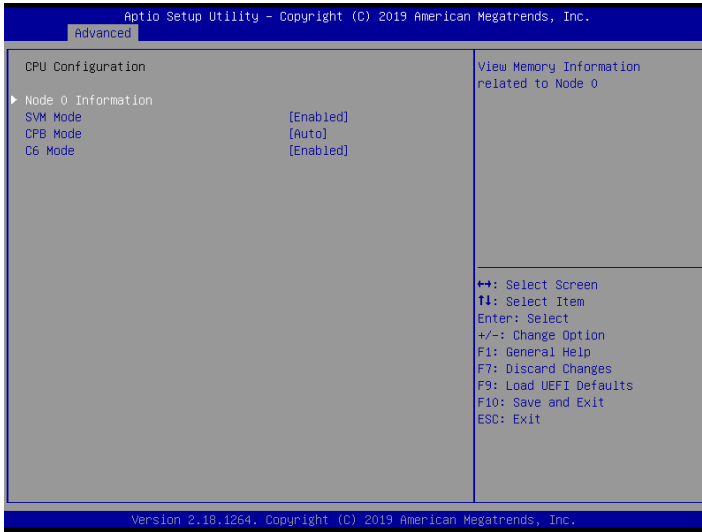

#### Node 0 Information

View Memory Information related to Node 0

#### SVM Mode

Enable/disable CPU Virtualization.

#### CPB Mode

Auto/disable CPB.

#### C6 Mode

Enable/disable C6.

## 3.3.2 Chipset Configuration

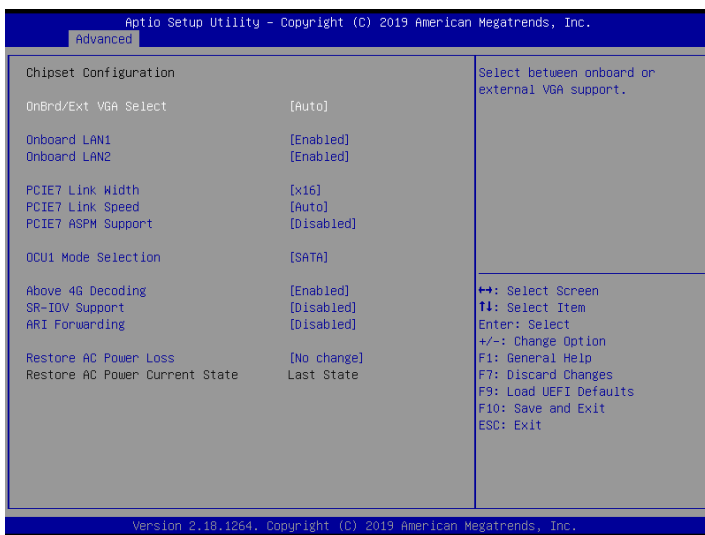

### OnBrd/Ext VGA Select

Select between onboard or external VGA support.

### Onboard LAN1

To enable or disable Onboard LAN.

### Onboard LAN2

To enable or disable Onboard LAN.

### PCIe7 Link Width

This allows you to select PCIe7 Link Width. The default value is [Auto].

### PCIe7 Link Speed

This allows you to select PCIe7 Link Speed. The default value is [Auto].

### PCIe7 ASPM Support

This option enables or disables the ASPM support for all CPU downstream devices.

### OCU1 Mode Selection

Switch the OCUlink to PCIe/SATA.

## Above 4G Decoding

Enable or disable 64bit capable Devices to be decoded in Above 4G Address Space (only if the system supports 64 bit PCI decoding).

## SR-IOV Support

If system has SR-IOV capable PCIe Devices, this option Enables or Disables Single Root IO Virtualization Support.

## ARI Forwarding

If supported by hardware and set to 'Enabled', the Downstream Port disables its traditional Device Number field being 0 enforcement when turning a Type1 Configuration Request into a Type0 Configuration Request, permitting access to Extended Functions in an ARI Device immediately below the Port.

## Restore AC Power Loss

This allows you to set the power state after a power failure. If [Power Off] is selected, the power will remain off when the power recovers. If [Power On] is selected, the system will start to boot up when the power recovers.

## Restore AC Power Current State

This allows you to restore AC Power Current State.

### 3.3.3 Storage Configuration

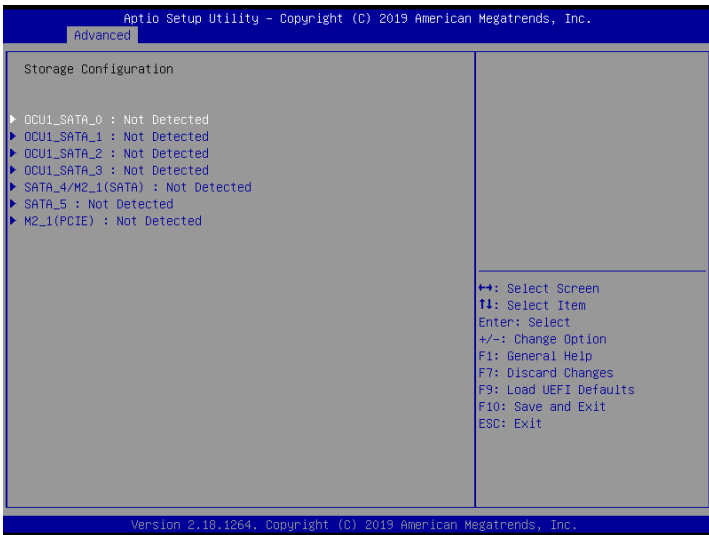

In this page, you can configure storage devices.



### 3.3.4 ACPI Configuration

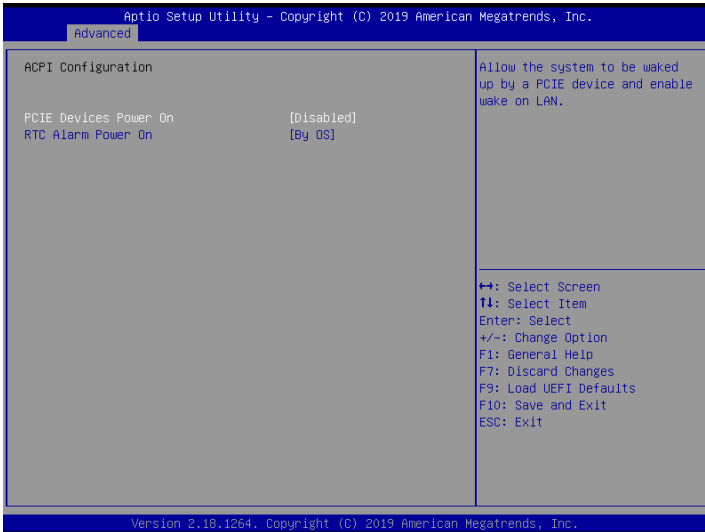

#### PCIE Devices Power On

Allow the system to be waked up by a PCIE device and enable wake on LAN.

#### RTC Alarm Power On

Use this item to enable or disable RTC (Real Time Clock) to power on the system.

### 3.3.5 USB Configuration

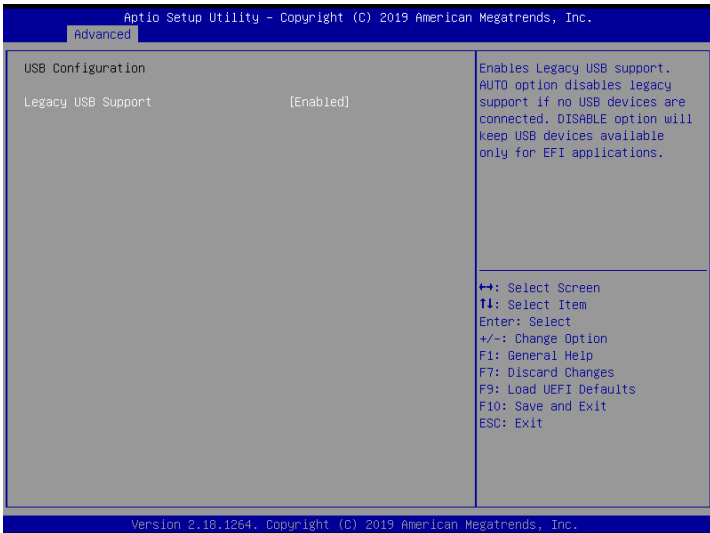

#### Legacy USB Support

Use this option to enable or disable legacy support for USB devices. The default value is [Enabled].

### 3.3.6 Super IO Configuration

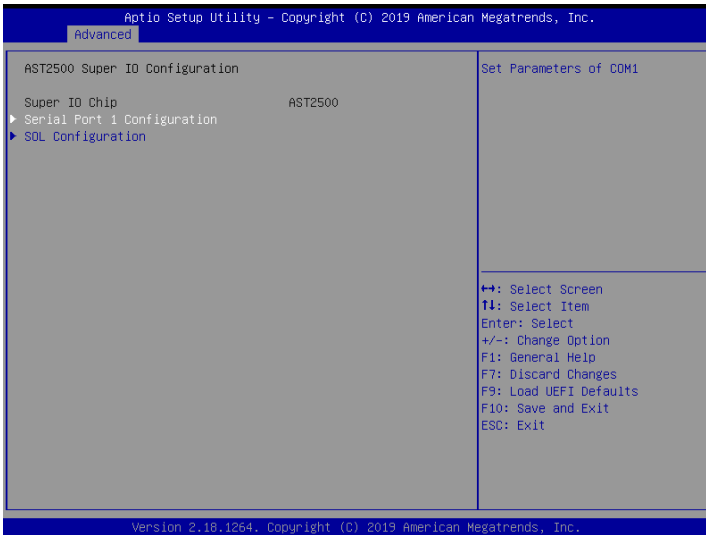

#### Serial Port 1 Configuration

Use this item to set parameters of Serial Port 1 (COM1).

#### Serial Port

Use this item to enable or disable the serial port.

#### Serial Port Address

Use this item to select an optimal setting for Super IO device.

#### SOL Configuration

Use this item to set parameters of SOL.

#### SOL Port

Use this item to set parameters of SOL.

#### Serial Port Address

Use this item to select an optimal setting for Super IO device.

## 3.3.7 Serial Port Console Redirection

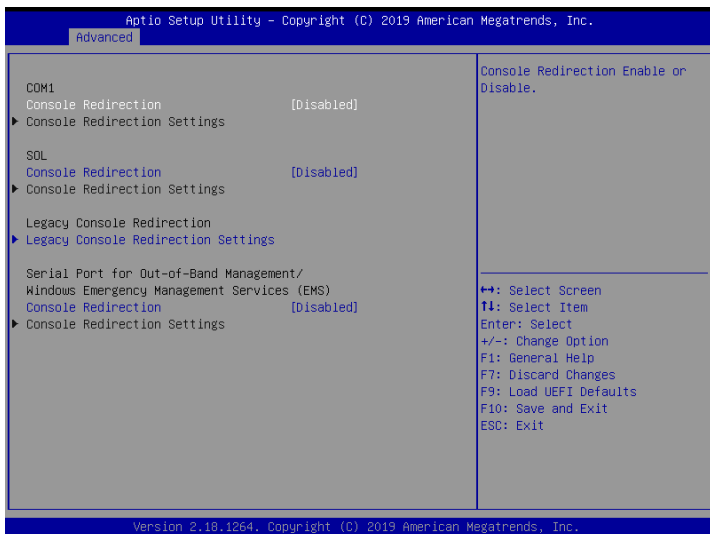

### COM1 / SOL

#### Console Redirection

Use this option to enable or disable Console Redirection. If this item is set to Enabled, you can select a COM Port to be used for Console Redirection.

#### Console Redirection Settings

Use this option to configure Console Redirection Settings, and specify how your computer and the host computer to which you are connected exchange information.

#### Terminal Type

Use this item to select the preferred terminal emulation type for out-of-band management. It is recommended to select [VT-UTF8].

Option	Description
VT100	ASCII character set
VT100+	Extended VT100 that supports color and function keys
VT-UTF8	UTF8 encoding is used to map Unicode chars onto 1 or more bytes
ANSI	Extended ASCII character set

**Bits Per Second**

Use this item to select the serial port transmission speed. The speed used in the host computer and the client computer must be the same. Long or noisy lines may require lower transmission speed. The options include [9600], [19200], [57600] and [115200].

**Data Bits**

Use this item to set the data transmission size. The options include [7] and [8] (Bits).

**Parity**

Use this item to select the parity bit. The options include [None], [Even], [Odd], [Mark] and [Space].

**Stop Bits**

The item indicates the end of a serial data packet. The standard setting is [1] Stop Bit. Select [2] Stop Bits for slower devices.

**Flow Control**

Use this item to set the flow control to prevent data loss from buffer overflow. When sending data, if the receiving buffers are full, a "stop" signal can be sent to stop the data flow. Once the buffers are empty, a "start" signal can be sent to restart the flow. Hardware flow uses two wires to send start/stop signals. The options include [None] and [Hardware RTS/CTS].

**VT-UTF8 Combo Key Support**

Use this item to enable or disable the VT-UTF8 Combo Key Support for ANSI/VT100 terminals.

**Recorder Mode**

Use this item to enable or disable Recorder Mode to capture terminal data and send it as text messages.

**Resolution 100x31**

Use this item to enable or disable extended terminal resolution support.

**Legacy OS Redirection Resolution**

Use this item to select the number of rows and columns used in legacy OS redirection.

**Putty Keypad**

Use this item to select Function Key and Keypad on Putty.

**Legacy Console Redirection****Legacy Console Redirection Settings**

Use this option to configure Legacy Console Redirection Settings, and specify how your computer and the host computer to which you are connected exchange information.

**Redirection COM Port**

Select a COM port to display redirection of Legacy OS and Legacy OPROM Messages.

## Resolution

On Legacy OS, the Number of Rows and Columns supported redirection.

## Redirect After POST

When Bootloader is selected, then Legacy Console Redirection is disabled before booting to legacy OS. When Always Enable is selected, then Legacy Console Redirection is enabled for legacy OS. Default setting for this option is set to Always Enable.

## Serial Port for Out-of-Band Management/Windows Emergency Management Services (EMS)

### Console Redirection

Use this option to enable or disable Console Redirection. If this item is set to Enabled, you can select a COM Port to be used for Console Redirection.

### Console Redirection Settings

Use this option to configure Console Redirection Settings, and specify how your computer and the host computer to which you are connected exchange information.

### Out-of-Band Mgmt Port

Microsoft Windows Emergency Management Services (EMS) allows for remote management of a Windows Server OS through a serial port.

### Terminal Type

Use this item to select the preferred terminal emulation type for out-of-band management. It is recommended to select [VT-UTF8].

Option	Description
VT100	ASCII character set
VT100+	Extended VT100 that supports color and function keys
VT-UTF8	UTF8 encoding is used to map Unicode chars onto 1 or more bytes
ANSI	Extended ASCII character set

### Bits Per Second

Use this item to select the serial port transmission speed. The speed used in the host computer and the client computer must be the same. Long or noisy lines may require lower transmission speed. The options include [9600], [19200], [57600] and [115200].

### Flow Control

Use this item to set the flow control to prevent data loss from buffer overflow. When sending data, if the receiving buffers are full, a "stop" signal can be sent to stop the data flow. Once the buffers are empty, a "start" signal can be sent to restart the flow. Hardware flow uses two wires to send start/stop signals. The options include [None], [Hardware RTS/CTS], and [Software Xon/Xoff].

**Data Bits**

**Parity**

**Stop Bits**

## 3.3.8 H/W Monitor

In this section, it allows you to monitor the status of the hardware on your system, including the parameters of the CPU temperature, motherboard temperature, CPU fan speed, chassis fan speed, and the critical voltage.

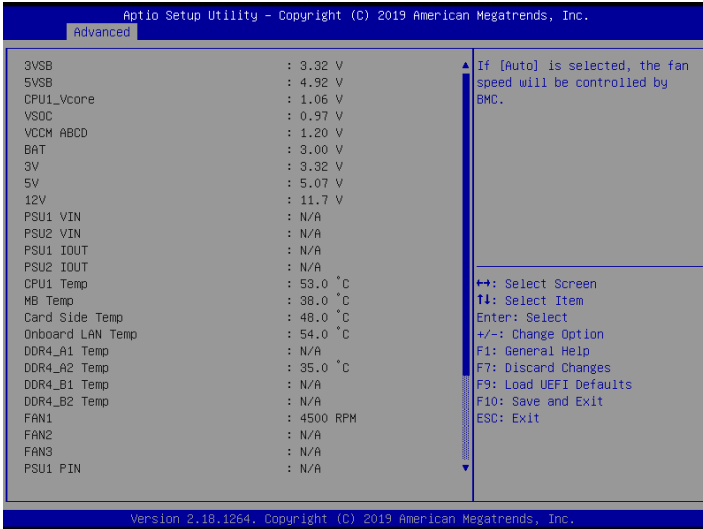

### Fan Control

If [Auto] is selected, the fan speed will be controlled by BMC.

If [Manual] is selected, configure the items below.

#### FAN1

This allows you to set the CPU fan1's speed. The default value is [Smart Fan].

#### FAN 2

This allows you to set the front fan 2's speed. The default value is [Smart Fan].

#### FAN 3

This allows you to set the front fan 3's speed. The default value is [Smart Fan].

### Smart Fan Control

This allows you to set the Smart fan's level speed.

#### Smart Fan Duty Control

Smart Fan Duty x (x means 1 to 11 stage)

This allows you to set duty cycle for each stage.



### **Smart Fan Temp Control**

Smart Fan Temp x (x means 1 to 11 stage)

This allows you to set temperature for each stage.

### **Watch Dog Timer**

This allows you to enable or disable the Watch Dog Timer. The default value is [Disabled].

### 3.3.9 PSP Firmware Versions

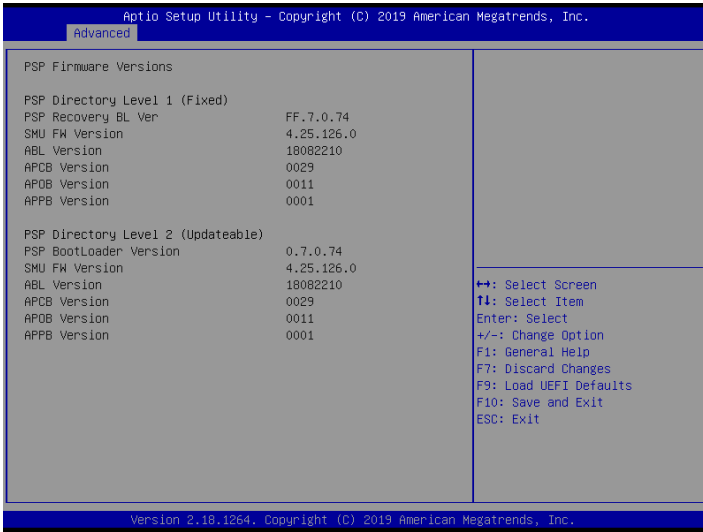

You can view information of PSP firmware versions in this page.

### 3.3.10 AMD CBS

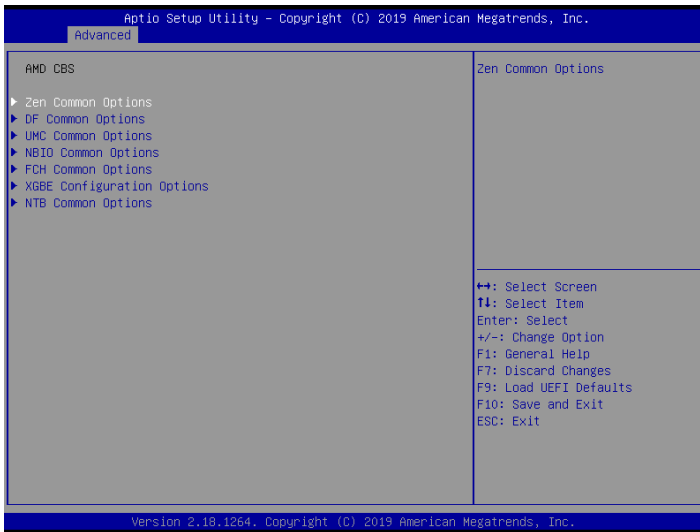

#### Zen Common Options

Use this item to configure Zen Common options.

#### DF Common Options

Use this item to configure DF Common options.

#### UMC Common Options

Use this item to configure UMC Common options.

#### NBIO Common Options

Use this item to configure NBIO Common options.

#### FCH Common Options

Use this item to configure FCH Common options.

#### XGBE Configuration Options

Use this item to configure XGBE Configuration options.

#### NTB Common Options

Use this item to configure NTB Common options.

### 3.3.11 Instant Flash

Instant Flash is a UEFI flash utility embedded in Flash ROM. This convenient UEFI update tool allows you to update system UEFI without entering operating systems first like MS-DOS or Windows. Just save the new UEFI file to your USB flash drive, floppy disk or hard drive and launch this tool, then you can update your UEFI only in a few clicks without preparing an additional floppy diskette or other complicated flash utility. Please be noted that the USB flash drive or hard drive must use FAT32/16/12 file system. If you execute Instant Flash utility, the utility will show the UEFI files and their respective information. Select the proper UEFI file to update your UEFI, and reboot your system after the UEFI update process is completed.

## 3.4 Server Mgmt

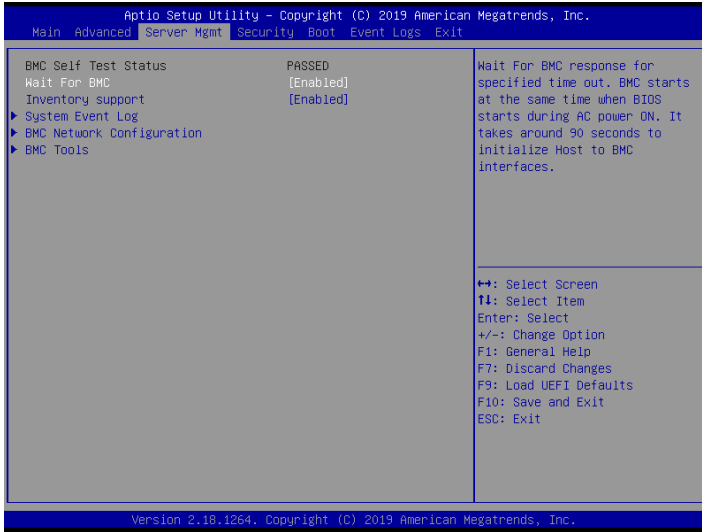

### Wait For BMC

Wait For BMC response for specified time out. BMC starts at the same time when BIOS starts during AC power ON. It takes around 90 seconds to initialize Host to BMC interfaces.

### Inventory Support

Use this item to execute inventory function for system. It will take more time at system boot when it is enabled.

## 3.4.1 System Event Log

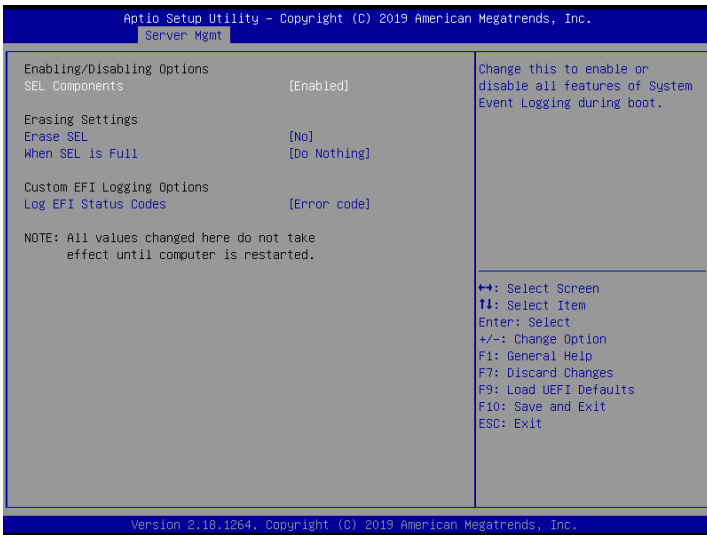

### SEL Components

Change this to enable or disable event logging for error/progress codes during boot.

### Erase SEL

Use this to choose options for erasing SEL.

### When SEL is Full

Use this to choose options for reactions to a full SEL.

### Log EFI Status Codes

Use this item to disable the logging of EFI Status Codes or log only error code or only progress code or both.

## 3.4.2 BMC Network Configuration

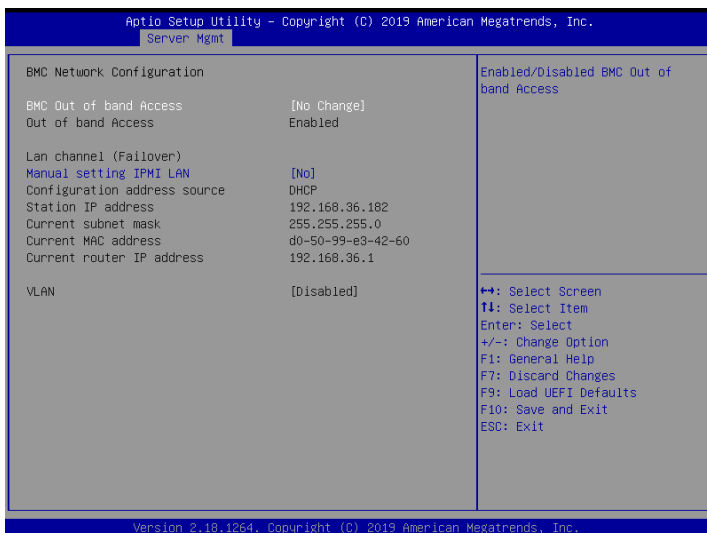

### BMC Out of Band Access

Enabled/Disabled BMC Out of band Access.

### Lan Channel (Failover)

### Manual Setting IPMI LAN

If [No] is selected, the IP address is assigned by DHCP. If you prefer using a static IP address, toggle to [Yes], and the changes take effect after the system reboots. The default value is [No].

### Configuration Address Source

Select to configure BMC network parameters statically or dynamically (by BIOS or BMC). Configuration options: [Static] and [DHCP].

**Static:** Manually enter the IP Address, Subnet Mask and Gateway Address in the BIOS for BMC LAN channel configuration.

**DHCP:** IP address, Subnet Mask and Gateway Address are automatically assigned by the network's DHCP server.



When [DHCP] or [Static] is selected, do NOT modify the BMC network settings on the IPMI web page.



*The default login information for the IPMI web interface is:*

*Username: admin*

*Password: admin*

*For more instructions on how to set up remote control environment and use the IPMI management platform, please refer to the IPMI Configuration User Guide or go to the Support website at: <http://www.asrockrack.com/support/faq.asp>*

## BMC Tools

### Load BMC Default Settings

Use this item to load BMC default settings.



## 3.5 Security

In this section, you may set or change the supervisor/user password for the system. For the user password, you may also clear it.

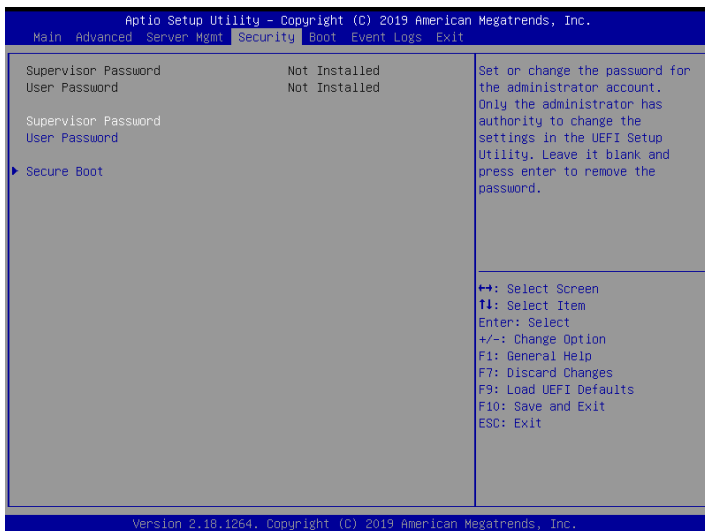

### Supervisor Password

Set or change the password for the administrator account. Only the administrator has authority to change the settings in the UEFI Setup Utility. Leave it blank and press enter to remove the password.

### User Password

Set or change the password for the user account. Users are unable to change the settings in the UEFI Setup Utility. Leave it blank and press enter to remove the password.

### Secure Boot

Use this to enable or disable Secure Boot Control. The default value is [Disabled]. Enable to support Windows Server 2012 R2 or later versions Secure Boot.

### Secure Boot Mode

Secure Boot mode options: Standard or Custom. In Custom mode, Secure Boot Policy variables can be configured by a physically present user without full authentication.

## 3.5.1 Key Management

In this section, expert users can modify Secure Boot Policy variables without full authentication.

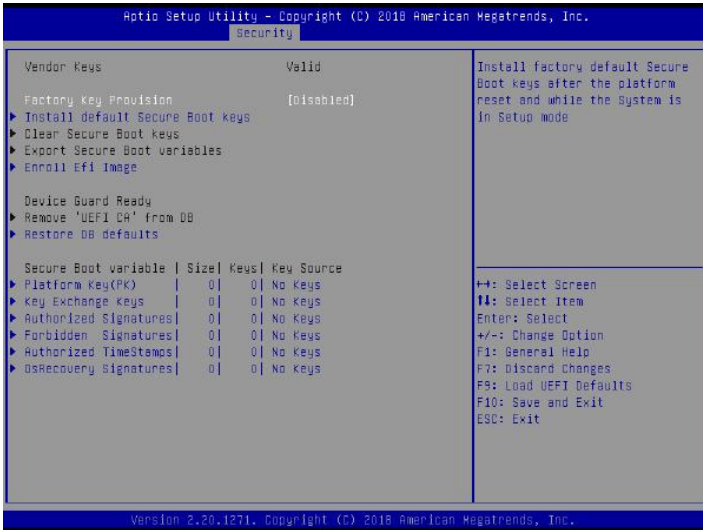

### Factory Key Provision

Install factory default Secure Boot keys after the platform reset and while the System is in Setup mode.

### Install Default Secure Boot Keys

Please install default secure boot keys if it's the first time you use secure boot.

### Clear Secure Boot keys

Force System to Setup Mode - clear all Secure Boot Variables. Change takes effect after reboot.

### Export Secure Boot variables

Copy NVRAM content of Secure Boot variables to files in a root folder on a file system device.

### Enroll Efi Image

Allow the image to run in Secure Boot mode. Enroll SHA256 Hash certificate of a PE image into Authorized Signature Database (db).

## Remove 'UEFI CA' from DB

Device Guard ready system must not list 'Microsoft UEFI CA' Certificate in Authorized Signature database (db).

## Restore DB defaults

Restore DB variable to factory defaults.

## Platform Key(PK)

Enroll Factory Defaults or load certificates from a file:

1. Public Key Certificate in:

- a) EFI\_SIGNATURE\_LIST
- b) EFI\_CERT\_X509 (DER)
- c) EFI\_CERT\_RSA2048 (bin)
- d) EFI\_CERT\_SHA256, 384, 512

2. Authenticated UEFI Variable

3. EFI PE/COFF Image(SHA256)

Key Source: Factory, External, Mixed

## Key Exchange Keys

Enroll Factory Defaults or load certificates from a file:

1. Public Key Certificate in:

- a) EFI\_SIGNATURE\_LIST
- b) EFI\_CERT\_X509 (DER encoded)
- c) EFI\_CERT\_RSA2048 (bin)
- d) EFI\_CERT\_SHA256, 384, 512

2. Authenticated UEFI Variable

3. EFI PE/COFF Image(SHA256)

Key Source: Factory, External, Mixed

## Authorized Signatures

Enroll Factory Defaults or load certificates from a file:

1. Public Key Certificate in:

- a) EFI\_SIGNATURE\_LIST
- b) EFI\_CERT\_X509 (DER encoded)
- c) EFI\_CERT\_RSA2048 (bin)
- d) EFI\_CERT\_SHA256, 384, 512

2. Authenticated UEFI Variable

3. EFI PE/COFF Image(SHA256)

Key Source: Factory, External, Mixed

## Forbidden Signatures

Enroll Factory Defaults or load certificates from a file:

1. Public Key Certificate in:

- a) EFI\_SIGNATURE\_LIST
- b) EFI\_CERT\_X509 (DER encoded)
- c) EFI\_CERT\_RSA2048 (bin)
- d) EFI\_CERT\_SHA256, 384, 512

2. Authenticated UEFI Variable

3. EFI PE/COFF Image(SHA256)

Key Source: Factory, External, Mixed

## Authorized TimeStamps

Enroll Factory Defaults or load certificates from a file:

1. Public Key Certificate in:

- a) EFI\_SIGNATURE\_LIST
- b) EFI\_CERT\_X509 (DER encoded)
- c) EFI\_CERT\_RSA2048 (bin)
- d) EFI\_CERT\_SHA256, 384, 512

2. Authenticated UEFI Variable

3. EFI PE/COFF Image(SHA256)

Key Source: Factory, External, Mixed

## OsRecovery Signatures

Enroll Factory Defaults or load certificates from a file:

1. Public Key Certificate in:

- a) EFI\_SIGNATURE\_LIST
- b) EFI\_CERT\_X509 (DER encoded)
- c) EFI\_CERT\_RSA2048 (bin)
- d) EFI\_CERT\_SHA256, 384, 512

2. Authenticated UEFI Variable

3. EFI PE/COFF Image(SHA256)

Key Source: Default, External, Mixed, Test

## 3.6 Boot Screen

In this section, it will display the available devices on your system for you to configure the boot settings and the boot priority.

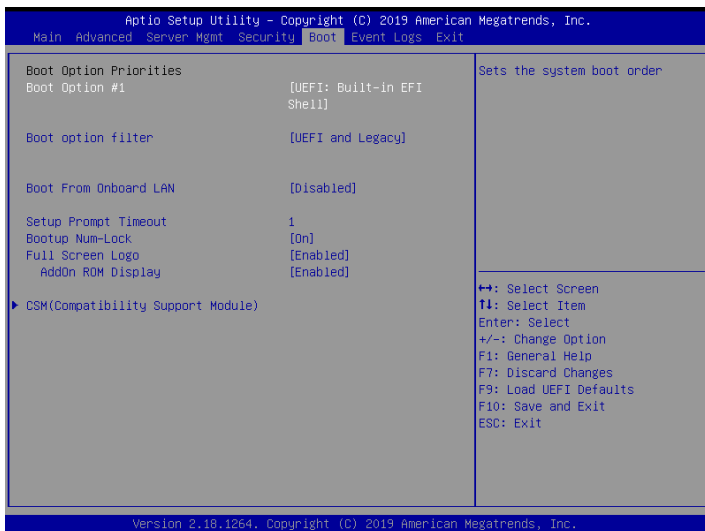

### Boot Option #1

Use this item to set the system boot order.

### Boot Option Filter

This option controls Legacy/UEFI ROMs priority.

### Boot From Onboard LAN

Use this item to enable or disable the Boot From Onboard LAN feature.

### Setup Prompt Timeout

Configure the number of seconds to wait for the UEFI setup utility.

### Bootup Num-Lock

If this item is set to [On], it will automatically activate the Numeric Lock function after boot-up.

### Full Screen Logo

Use this item to enable or disable OEM Logo. The default value is [Enabled].

## AddOn ROM Display

Use this option to adjust AddOn ROM Display. If you enable the option “Full Screen Logo” but you want to see the AddOn ROM information when the system boots, please select [Enabled]. Configuration options: [Enabled] and [Disabled]. The default value is [Enabled].

## 3.6.1 CSM Parameters

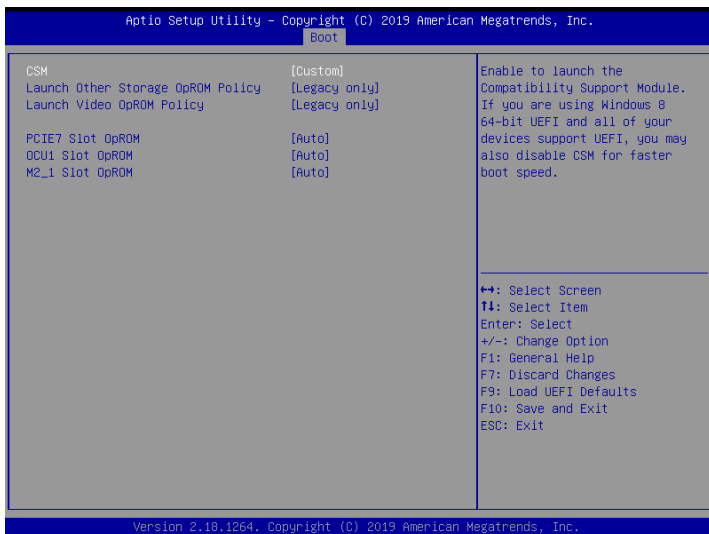

### CSM

Enable to launch the Compatibility Support Module. Please do not disable unless you're running a WHCK test. If you are using Windows Server 2012 R2 or later versions 64-bit UEFI and all of your devices support UEFI, you may also disable CSM for faster boot speed.

### Launch Other Storage OpROM Policy

Select UEFI only to run those that support UEFI option ROM only. Select Legacy only to run those that support legacy option ROM only. Select Do not launch to not execute both legacy and UEFI option ROM.

### Launch Video OpROM Policy

Select UEFI only to run those that support UEFI option ROM only. Select Legacy only to run those that support legacy option ROM only. Select Do not launch to not execute both legacy and UEFI option ROM.

### PCIe7 Slot OpROM

To select Slot Storage and Network Option ROM policy. In Auto option, the default is Disabled with NVMe device, but it is Legacy with other devices. (This item can't select Video Option ROM policy.)



## OCU1 Slot OpROM

To select Slot Storage and Network Option ROM policy. In Auto option, the default is Disabled with NVMe device, but it is Legacy with other devices. (This item can't select Video Option ROM policy.)

## M2\_1 Slot OpROM

To select Slot Storage and Network Option ROM policy. In Auto option, the default is Disabled with NVMe device, but it is Legacy with other devices. (This item can't select Video Option ROM policy.)

## 3.7 Event Logs

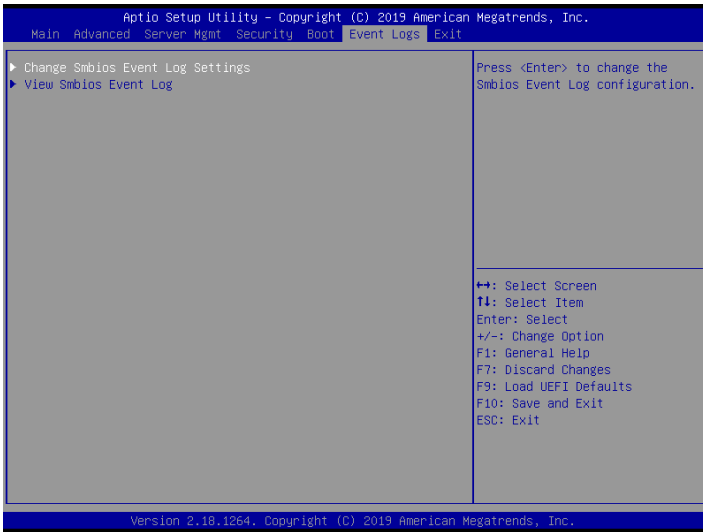

### Change Smbios Event Log Settings

This allows you to configure the Smbios Event Log Settings.

When entering the item, you will see the followings:

#### **Smbios Event Log**

Use this item to enable or disable all features of the SMBIOS Event Logging during system boot.

#### **Erase Event Log**

The options include [No], [Yes, Next reset] and [Yes, Every reset]. If Yes is selected, all logged events will be erased.

#### **When Log is Full**

Use this item to choose options for reactions to a full Smbios Event Log. The options include [Do Nothing] and [Erase Immediately].

#### **Log System Boot Event**

Choose option to enable/disable logging of System boot event.

#### **MECI (Multiple Event Count Increment)**

Use this item to enter the increment value for the multiple event counter. The valid range is from 1 to 255.

#### **METW (Multiple Event Time Window)**

Use this item to specify the number of minutes which must pass between duplicate log

entries which utilize a multiple-event counter. The value ranges from 0 to 99 minutes.

### View Smbios Event Log

Press <Enter> to view the Smbios Event Log records.



*All values changed here do not take effect until computer is restarted.*

## 3.8 Exit Screen

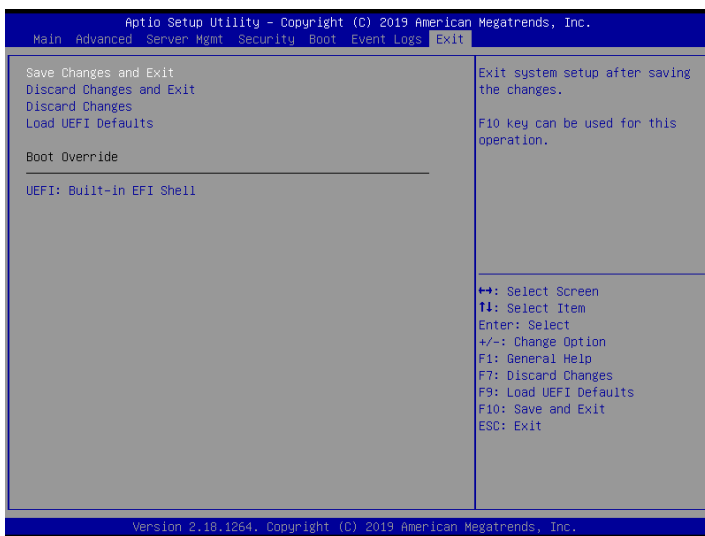

### Save Changes and Exit

When you select this option, the following message “Save configuration changes and exit setup?” will pop-out. Press <F10> key or select [Yes] to save the changes and exit the UEFI SETUP UTILITY.

### Discard Changes and Exit

When you select this option, the following message “Discard changes and exit setup?” will pop-out. Press <ESC> key or select [Yes] to exit the UEFI SETUP UTILITY without saving any changes.

### Discard Changes

When you select this option, the following message “Discard changes?” will pop-out. Press <F7> key or select [Yes] to discard all changes.

### Load UEFI Defaults

Load UEFI default values for all the setup questions. F9 key can be used for this operation.

## Chapter 4 Software Support

### 4.1 Install Operating System

This motherboard supports various Microsoft® Windows® Server 2016 / 2019 / Linux compliant. Because motherboard settings and hardware options vary, use the setup procedures in this chapter for general reference only. Refer to your OS documentation for more information.

*\*Please download the Intel® SATA Floppy Image driver from the ASRock Rack's website ([www.asrockrack.com](http://www.asrockrack.com)) to your USB drive or simply install the SATA driver from the Support CD while installing OS in SATA RAID mode.*

### 4.2 Support CD Information

The Support CD that came with the motherboard contains necessary drivers and useful utilities that enhance the motherboard's features.

#### 4.2.1 Running The Support CD

To begin using the support CD, insert the CD into your CD-ROM drive. The CD automatically displays the Main Menu if "AUTORUN" is enabled in your computer. If the Main Menu does not appear automatically, locate and double click on the file "ASRSetup.exe" from the root folder in the Support CD to display the menu.

#### 4.2.2 Drivers Menu

The Drivers Menu shows the available device's drivers if the system detects installed devices. Please install the necessary drivers to activate the devices.

#### 4.2.3 Utilities Menu

The Utilities Menu shows the application softwares that the motherboard supports. Click on a specific item then follow the installation wizard to install it.

#### 4.2.4 Contact Information

If you need to contact ASRock Rack or want to know more about ASRock Rack, welcome to visit ASRock Rack's website at <http://www.ASRockRack.com>; or you may contact your dealer for further information.

# Chapter 5 Troubleshooting

## 5.1 Troubleshooting Procedures

Follow the procedures below to troubleshoot your system.



*Always unplug the power cord before adding, removing or changing any hardware components. Failure to do so may cause physical injuries to you and damages to motherboard components.*

1. Disconnect the power cable and check whether the PWR LED is off.
2. Unplug all cables, connectors and remove all add-on cards from the motherboard. Make sure that the jumpers are set to default settings.
3. Confirm that there are no short circuits between the motherboard and the chassis.
4. Install a CPU and fan on the motherboard, then connect the chassis speaker and power LED.

### **If there is no power...**

1. Confirm that there are no short circuits between the motherboard and the chassis.
2. Make sure that the jumpers are set to default settings.
3. Check the settings of the 115V/230V switch on the power supply.
4. Verify if the battery on the motherboard provides ~3VDC. Install a new battery if it does not.

### **If there is no video...**

1. Try replugging the monitor cables and power cord.
2. Check for memory errors.

### **If there are memory errors...**

1. Verify that the DIMM modules are properly seated in the slots.
2. Use recommended DDR4 ECC/UDIMM, RDIMMs.
3. If you have installed more than one DIMM modules, they should be identical with the same brand, speed, size and chip-type.
4. Try inserting different DIMM modules into different slots to identify faulty ones.
5. Check the settings of the 115V/230V switch on the power supply.

**Unable to save system setup configurations...**

1. Verify if the battery on the motherboard provides ~3VDC. Install a new battery if it does not.
2. Confirm whether your power supply provides adequate and stable power.

**Other problems...**

1. Try searching keywords related to your problem on ASRock Rack's FAQ page:  
<http://www.asrockrack.com/support>

## 5.2 Technical Support Procedures

If you have tried the troubleshooting procedures mentioned above and the problems are still unsolved, please contact ASRock Rack's technical support with the following information:

1. Your contact information
2. Model name, BIOS version and problem type.
3. System configuration.
4. Problem description.

You may contact ASRock Rack's technical support at:  
<http://www.asrockrack.com/support/tsd.asp>

## 5.3 Returning Merchandise for Service

For warranty service, the receipt or a copy of your invoice marked with the date of purchase is required. By calling your vendor or going to our RMA website (<http://event.asrockrack.com/tsd.asp>) you may obtain a Returned Merchandise Authorization (RMA) number.

The RMA number should be displayed on the outside of the shipping carton which is mailed prepaid or hand-carried when you return the motherboard to the manufacturer. Shipping and handling charges will be applied for all orders that must be mailed when service is complete.

This warranty does not cover damages incurred in shipping or from failure due to alteration, misuse, abuse or improper maintenance of products.

Contact your distributor first for any product related problems during the warranty period.