

ET51/56

Enterprise Tablet

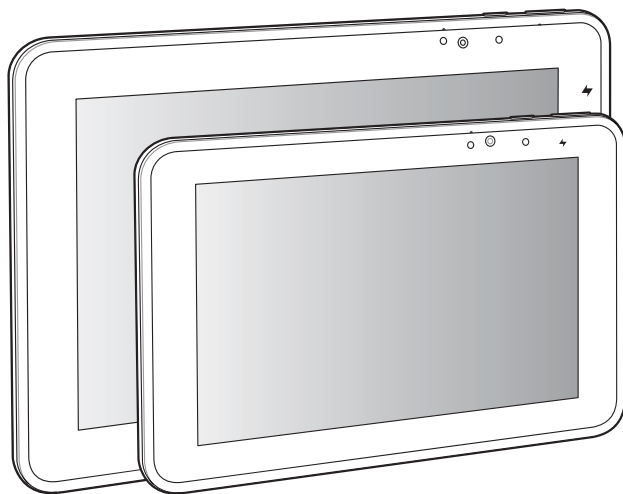

Quick Reference Guide



ZEBRA

Copyright

ZEBRA and the stylized Zebra head are trademarks of Zebra Technologies Corporation, registered in many jurisdictions worldwide. All other trademarks are the property of their respective owners. ©2019 Zebra Technologies Corporation and/or its affiliates. All rights reserved.

COPYRIGHTS & TRADEMARKS: For complete copyright and trademark information, go to www.zebra.com/copyright.

WARRANTY: For complete warranty information, go to www.zebra.com/warranty.

END USER LICENSE AGREEMENT: For complete EULA information, go to www.zebra.com/eula.

Terms of Use

- Proprietary Statement

This manual contains proprietary information of Zebra Technologies Corporation and its subsidiaries (“Zebra Technologies”). It is intended solely for the information and use of parties operating and maintaining the equipment described herein. Such proprietary information may not be used, reproduced, or disclosed to any other parties for any other purpose without the express, written permission of Zebra Technologies.

- Product Improvements

Continuous improvement of products is a policy of Zebra Technologies. All specifications and designs are subject to change without notice.

- Liability Disclaimer

Zebra Technologies takes steps to ensure that its published Engineering specifications and manuals are correct; however, errors do occur. Zebra Technologies reserves the right to correct any such errors and disclaims liability resulting therefrom.

- Limitation of Liability

In no event shall Zebra Technologies or anyone else involved in the creation, production, or delivery of the accompanying product (including hardware and software) be liable for any damages whatsoever (including, without limitation, consequential damages including loss of business profits, business interruption, or loss of business information) arising out of the use of, the results of use of, or inability to use such product, even if Zebra Technologies has been advised of the possibility of such damages. Some jurisdictions do not allow the exclusion or limitation of incidental or consequential damages, so the above limitation or exclusion may not apply to you.

Warranty

For the complete Zebra hardware product warranty statement, go to www.zebra.com/warranty.

Service Information

If you have a problem using the equipment, contact your facility’s Technical or Systems Support. If there is a problem with the equipment, they will contact the Zebra Support at: zebra.com/support.

For the latest version of this guide go to: zebra.com/support.

Introduction

The ET51 is a wireless LAN (WLAN) tablet and the ET56 is a wireless WAN (WWAN) tablet.

Features

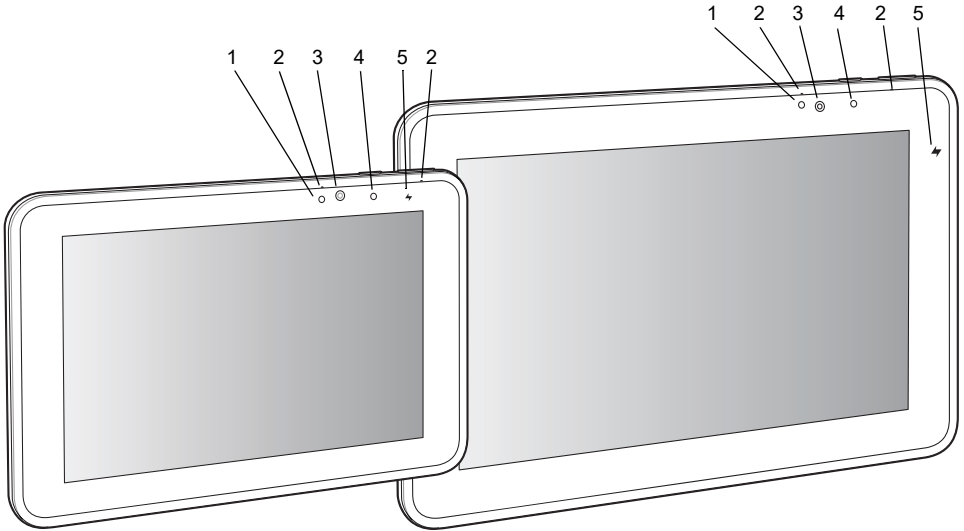

Item	Description
1	Ambient Light Sensor - Recognizes the ambient light and adjusts the display brightness (if enabled).
2	Front Microphones - Use for voice communications or audio recordings.
3	Front Facing Camera - Use for video conferencing or capturing images and video.
4	Camera Indicator LED - Lights red when the camera is activate. Momentarily lights red when the device boots and shuts down.
5	Charging Indicator LED - Indicates charging status. OFF - device is not connected to charger. ORANGE - device is charging. GREEN - device is connected and fully charged. RED - charge error.

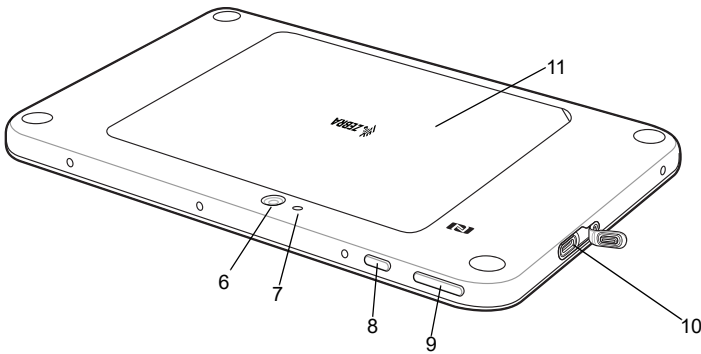

Item	Description
6	Rear Camera - Use for high resolution images and video.
7	Camera LED Flash - Provides illumination for the camera.
8	Power Button - Push once to start the device; push it again to enable sleep mode. Push and hold it to shut down the device.
9	Volume Key - Push the left side to reduce the volume. Press the right side to increase the volume.
10	USB-C Interface - Provides for communication.
11	Back Cover - Covers the service replaceable battery.

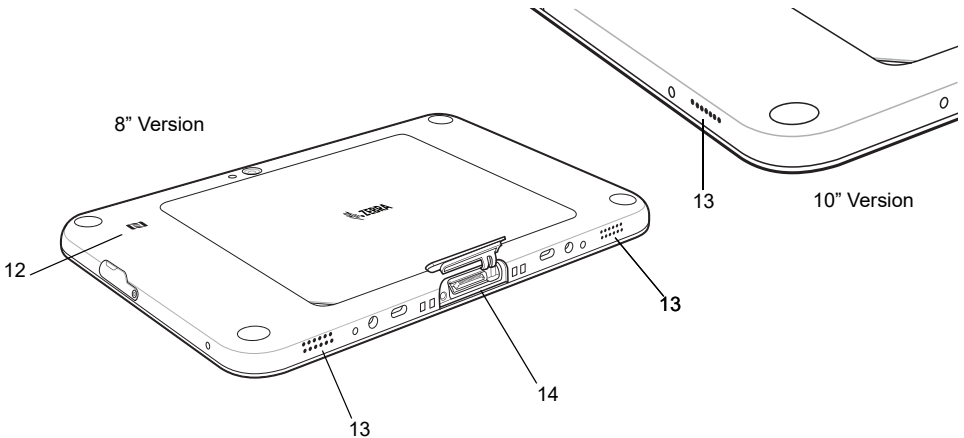

Item	Description
12	NFC Antenna Position - Use to read NFC cards and RFID tags.
13	Stereo Speakers - Provides audio playback.
14	Docking Connector - Interfaces with the cradle.

Installing a micro SD Card or SIM Card

To install a microSD card and/or nano SIM card (ET56 only):

1. Press the Power button to turn off the device.
2. Lift the notched corner of the battery cover.

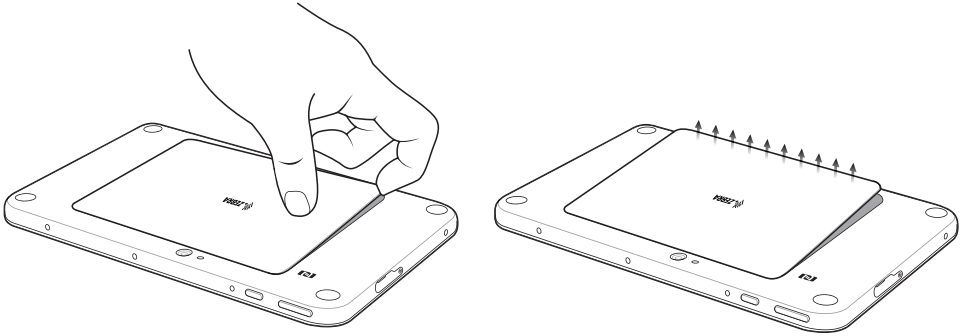

3. Carefully lift the battery cover off the device.
4. On the 8" version, push the two locking tabs up, then pull up on the tab to remove battery.
On the 10" version, push the two locking tabs up (1), then, using index fingers, lift the battery up (2).

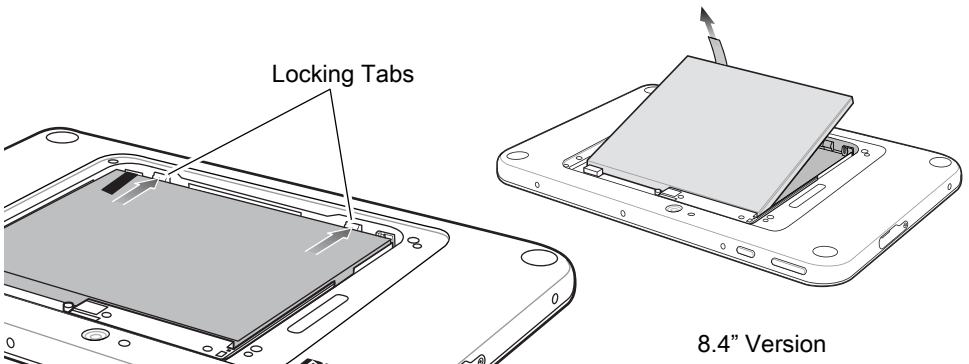

8.4" Version

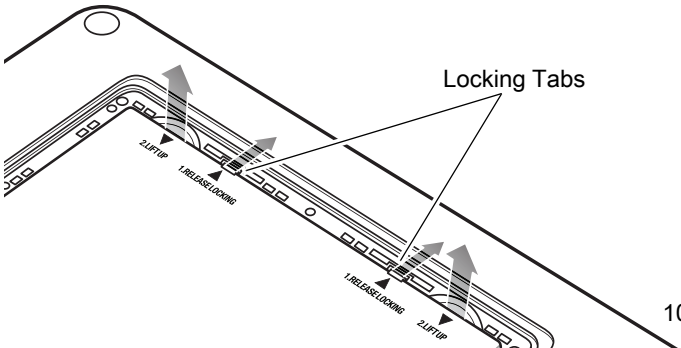

10.1" Version

5. Insert the microSD card with contacts facing down.

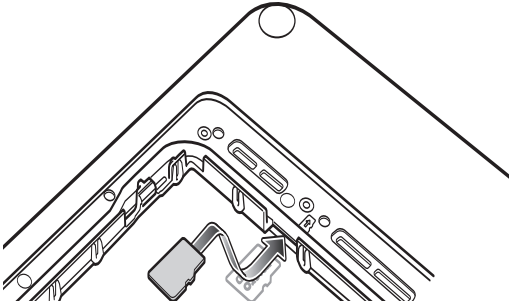

8.4" Version

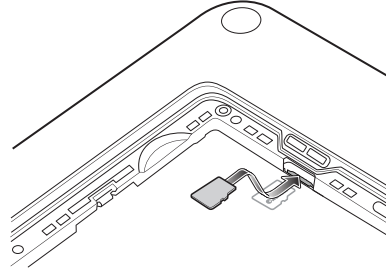

10.1" Version

6. Push the micro SD card in and ensure that it locks into place.

7. Insert the nano SIM card with contacts facing down.

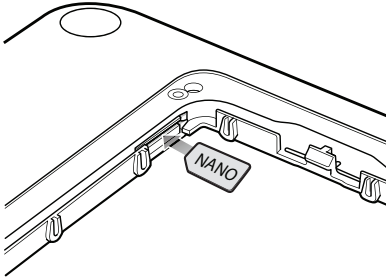

8.4" Version

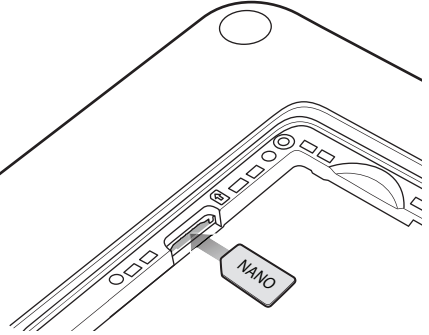

10.1" Version

8. Push the SIM card in and ensure that it locks into place.

9. Replace the battery.

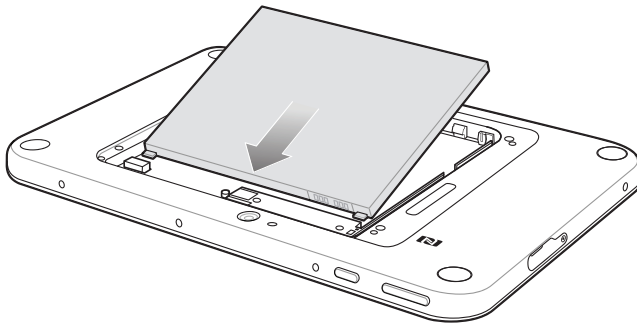

CAUTION: Be aware of the orientation of the battery cover. Failure to replace the battery cover properly may damage the battery cover.

10. Align the tabs on the underside of the cover with the slot around the battery well. Make sure that the notch on the battery cover is at the bottom left corner of the device.

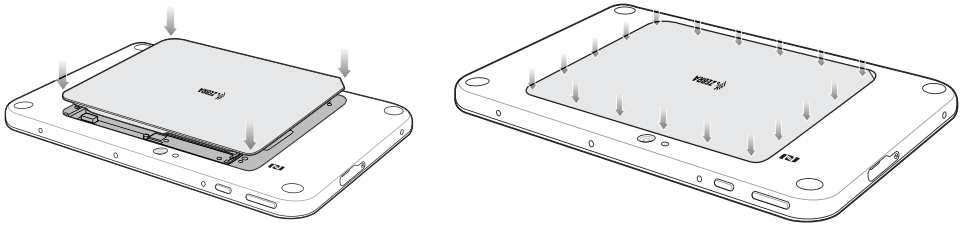

11. Carefully press down around the edge of the cover. Make sure that the cover is seated properly.
12. Press Power button to turn on the device.

Charging the Device

Use the Communication and Charging Cradle, Rugged Communication and Charging Cradle or Charge Only Cradle to charge the device. See ET51/56 User Guide for more information.

NOTE: The Charge Only Cradle (CRD-ET5X-1SCG1) and the Communication and Charge Cradle (CRD-ET5X-1SCOM1) come with two inserts; tall insert and short insert. Install the tall insert when using a device without a Rugged Frame and Expansion Back. Install the small insert when using a device with an Expansion Back and without a Rugged Frame. Do not install either insert when using the device with the Rugged Frame.

The Rugged Communication and Charge Cradle (CRD-ET5X-1SCOM1R) does not come with inserts. Use with device and Rugged Frame with IO Adapter.

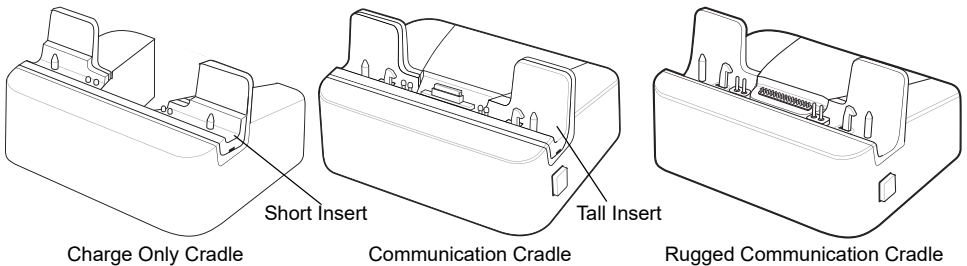

Setup the Charge Only Cradle or Communication Cradle, power supply, PWR-BGA12V50W0WW, DC Line Cord CBL-DC-388A1-01 and country-specific AC line cord, sold separately.

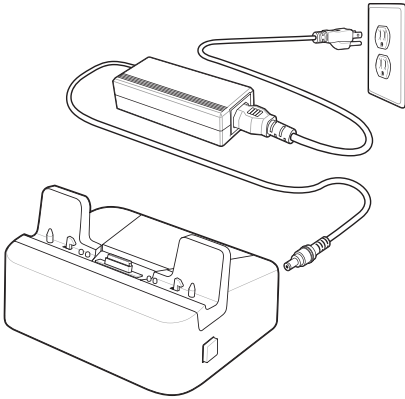

1. If using the Communication and Charging Cradle, open the bottom access door and hold it to the back of the tablet.
2. Align the device with the alignment pins on the cradle.
3. Insert the device into the cradle. Note that the Communication Cradle contains a locking mechanism that locks the device to the cradle.

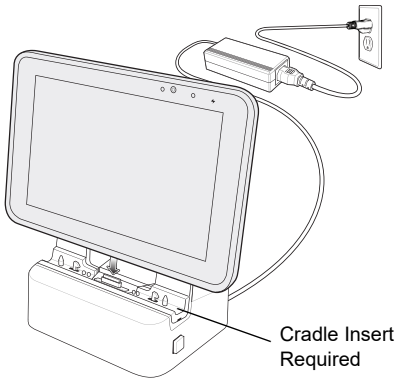

Communication and Charging Cradle

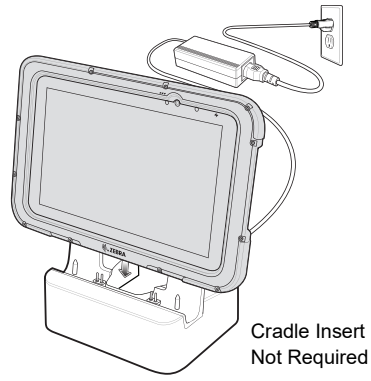

Charge Only Cradle

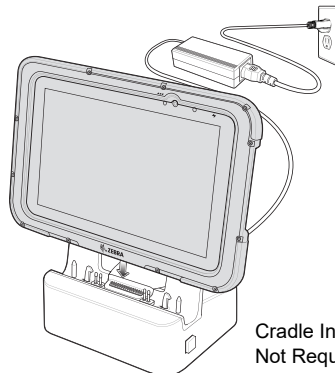

Rugged Communication and Charging Cradle

4. The Charging LED indicates charging.
5. To remove the device from the Charge Only cradle, hold the cradle down with one hand and lift the device.

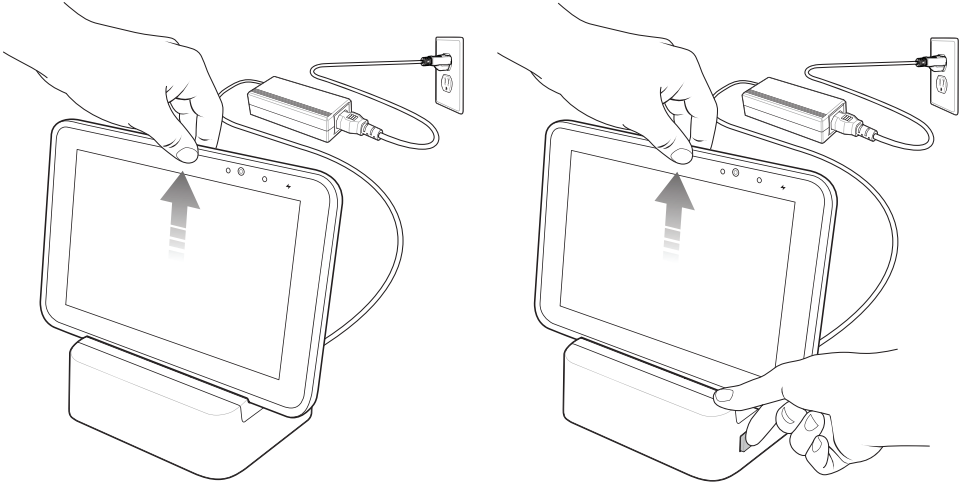

To remove the device from either Communication Cradle, press the release button on the right side of the cradle and lift the device. Use thumb to hold down the cradle.

The 8.4" tablet main battery charges from fully depleted to 90% in approximately 2 hours and from fully depleted to 100% in approximately 3 hours.

The 10.1" tablet main battery charges from fully depleted to 90% in approximately 3 hours and from full depleted to 100% in approximately 5 hours.

Using the Camera

To take photos or videos:

1. Open the Camera application. The Camera Indicator LED lights red.
2. Point the device camera at an object.
3. Touch the on-screen shutter button to take a photo or record a video.



Reading NFC Cards

The device supports reading NFC cards. The NFC antenna is located on the back of the device under the NFC logo.

With an NFC enabled application open, bring the NFC card toward the antenna. Depending upon the application, an audio or visual indication indicates successful reading of the card.

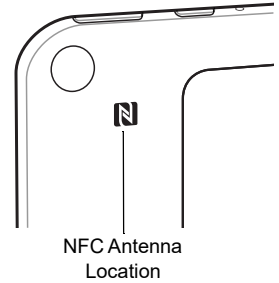
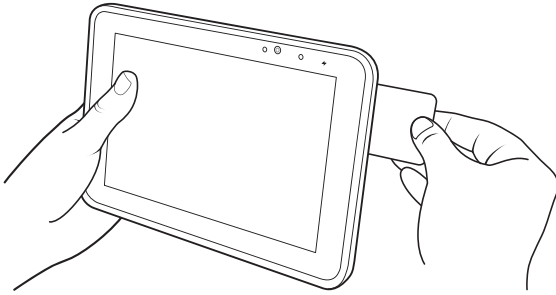

Regulatory Information

This device is approved under Zebra Technologies Corporation.

This guide applies to the following Model Numbers: ET51AE, ET51AT, ET51CE, ET51CT, ET56BE, ET56BT, and ET56DE.

All Zebra devices are designed to be compliant with rules and regulations in locations they are sold and will be labeled as required.

Local language translations are available at the following website: www.zebra.com/support.

Any changes or modifications to Zebra equipment, not expressly approved by Zebra, could void the user's authority to operate the equipment.

Declared maximum operating temperature: +50°C.

⚠ CAUTION: Only use Zebra approved and UL Listed accessories, battery packs and battery chargers.

Do NOT attempt to charge damp/wet mobile computers or batteries. All components must be dry before connecting to an external power source.

UL Listed Products with GPS

Underwriters Laboratories Inc. (UL) has not tested the performance or reliability of the Global Positioning System (GPS) hardware, operating software, or other aspects of this product. UL has only tested for fire, shock, or casualties as outlined in UL's Standard(s) for Safety for Information Technology Equipment, UL60950-1. UL Certification does not cover the performance or reliability of the GPS hardware and GPS operating software. UL makes no representations, warranties, or certifications whatsoever regarding the performance or reliability of any GPS related functions of this product.

Radio Modules

The device contains approved radio module(s). These module(s) are identified below.

ET56Bx tablets:

- Telit LN940A9 PCI Express radio card, FCC ID: RI7LN940A (LTE, HSPA+)

Bluetooth® Wireless Technology

This is an approved Bluetooth® product. For more information or to view the End Product Listing, please visit www.bluetooth.org/tpg/listings.cfm.

Wireless Device Country Approvals

Regulatory markings subject to certification are applied to the device signifying the radio(s) is/are approved for use in the following countries and continents: United States, Canada, Japan, China, South Korea, Australia, and Europe.

Please refer to the Declaration of Conformity (DoC) for details of other country markings. This is available at: www.zebra.com/doc.

Note: Europe includes Austria, Belgium, Bulgaria, Croatia, Czech Republic, Cyprus, Denmark, Estonia, Finland, France, Germany, Greece, Hungary, Iceland, Ireland, Italy, Latvia, Liechtenstein, Lithuania, Luxembourg, Malta, Netherlands, Norway, Poland, Portugal, Romania, Slovak Republic, Slovenia, Spain, Sweden, Switzerland, and the United Kingdom.



CAUTION: Operation of the device without regulatory approval is illegal.

Country Roaming

This device incorporates the International Roaming feature (IEEE802.11d), which will ensure the product operates on the correct channels for the particular country of use.

Wi-Fi Direct / Hotspot Mode



NOTE: ET51CE, ET51CT, and ET56DE only.

Operation is limited to the following channels/bands as supported in the country of use:

- Channels 1 - 11 (2,412 - 2,462 MHz)
- Channels 36 - 48 (5,150 - 5,250 MHz)
- Channels 149 - 165 (5,745 - 5,825 MHz)

Wi-Fi Direct

Operation is limited to the following channels/bands as supported in the country of use:

- Channels 1 - 11 (2,412 - 2,462 MHz)
- Channels 36 - 48 (5,150 - 5,250 MHz)
- Channels 149 - 165 (5,745 - 5,825 MHz)

Frequency of Operation – FCC and IC

5 GHz Only

Industry Canada Statement

 **CAUTION:** The device for the band 5,150 - 5,250 MHz is only for indoor usage to reduce potential for harmful interference to co-Channel mobile satellite systems. High power radars are allocated as primary users (meaning they have priority) of 5,250 - 5,350 MHz and 5,650 - 5,850 MHz and these radars could cause interference and/or damage to LE-LAN devices.

 **CAUTION:** Le dispositif fonctionnant dans la bande 5,150 - 5,250 MHz est réservé uniquement pour une utilisation à l'intérieur afin de réduire les risques de brouillage préjudiciable aux systèmes de satellites mobiles utilisant les mêmes canaux. Les utilisateurs de radars de haute puissance sont désignés utilisateurs principaux (c.-à-d., qu'ils ont la priorité) pour les bands 5,250 - 5,350 MHz et 5,650 - 5,850 MHz et que ces radars pourraient causer du brouillage et/ou des dommages aux dispositifs LAN-EL.

2.4 GHz Only

The available channels for 802.11 operation in the US are Channels 1 to 11. The range of channels is limited by firmware.

Health and Safety Recommendations

Ergonomic Recommendations

 **CAUTION:** In order to avoid or minimize the potential risk of ergonomic injury follow the recommendations below. Consult with your local Health & Safety Manager to ensure that you are adhering to your company's safety programs to prevent employee injury.

- Reduce or eliminate repetitive motion
- Maintain a natural position
- Reduce or eliminate excessive force
- Keep objects that are used frequently within easy reach
- Perform tasks at correct heights
- Reduce or eliminate vibration
- Reduce or eliminate direct pressure
- Provide adjustable workstations
- Provide adequate clearance
- Provide a suitable working environment
- Improve work procedures.

Vehicle Installation

RF signals may affect improperly installed or inadequately shielded electronic systems in motor vehicles (including safety systems). Check with the manufacturer or its representative regarding your vehicle. You should also consult the manufacturer about any equipment that has been added to your vehicle.

An air bag inflates with great force. DO NOT place objects, including either installed or portable wireless equipment, in the area over the air bag or in the air bag deployment area. If in-vehicle wireless equipment is improperly installed and the air bag inflates, serious injury could result.

Position the device within easy reach. Be able to access the device without removing your eyes from the road.

 **NOTE:** Connection to an alert device that will cause a vehicle horn to sound or lights to flash on receipt of a call on public roads is not permitted.

 **IMPORTANT:** Before installing or using, check state and local laws regarding windshield mounting and use of equipment.

For Safe Installation

- Do not put your phone in a location that obstructs the drivers vision or interferes with the operation of the Vehicle.
- Do not cover an airbag.

Safety on the Road

Do not take notes or use the device while driving. Jotting down a “to do” list or flipping through your address book takes attention away from your primary responsibility, driving safely.

When driving a car, driving is your first responsibility - Give full attention to driving. Check the laws and regulations on the use of wireless devices in the areas where you drive. Always obey them.

Warnings for Use of Wireless Devices

 **CAUTION:** Please observe all warning notices with regard to the usage of wireless devices.

Potentially Hazardous Atmospheres – Vehicles Use

You are reminded of the need to observe restrictions on the use of radio devices in fuel depots, chemical plants etc. and areas where the air contains chemicals or particles (such as grain, dust, or metal powders) and any other area where you would normally be advised to turn off your vehicle engine.

Safety in Aircraft

Switch off your wireless device whenever you are instructed to do so by airport or airline staff. If your device offers a ‘flight mode’ or similar feature, consult airline staff as to its use in flight.

Safety in Hospitals

Wireless devices transmit radio frequency energy and may affect medical electrical equipment.

Wireless devices should be switched off wherever you are requested to do so in hospitals, clinics, or healthcare facilities. These requests are designed to prevent possible interference with sensitive medical equipment.

Pacemakers

Pacemaker manufacturers recommended that a minimum of 15 cm (6 inches) be maintained between a handheld wireless device and a pacemaker to avoid potential interference with the pacemaker. These recommendations are consistent with independent research and recommendations by Wireless Technology Research.

Persons with Pacemakers:

- Should ALWAYS keep the device more than 15 cm (6 inches) from their pacemaker when turned ON.
- Should not carry the device in a breast pocket.
- Should use the ear furthest from the pacemaker to minimize the potential for interference.
- If you have any reason to suspect that interference is taking place, turn OFF your device.

Other Medical Devices

Please consult your physician or the manufacturer of the medical device, to determine if the operation of your wireless product may interfere with the medical device.

RF Exposure Guidelines

Safety Information

Reducing RF Exposure – Use Properly

Only operate the device in accordance with the instructions supplied.

International

The device complies with internationally recognized standards covering human exposure to electromagnetic fields from radio devices. For information on “International” human exposure to electromagnetic fields refer to the Zebra Declaration of Conformity (DoC) at www.zebra.com/doc.

For further information on the safety of RF energy from wireless devices, see zebra.com/responsibility located under Corporate Responsibility.

Europe

Handheld Devices

This device was tested for typical body-worn operation. Use only Zebra tested and approved belt-clips, holsters, and similar accessories to ensure EU Compliance.

US and Canada

Co-located statement

To comply with FCC RF exposure compliance requirement, the antenna used for this transmitter must not be co-located or operating in conjunction with any other transmitter/antenna except those already approved in this filling.

Use only Zebra tested and approved belt clips, holsters, and similar accessories to ensure FCC Compliance. The use of third-party belt clips, holsters, and similar accessories may not comply with FCC RF exposure compliance requirements and should be avoided. The FCC has granted an Equipment Authorization for these model phones with all reported SAR levels evaluated as in compliance with the FCC RF emission guidelines. SAR information on these model phones is on file with the FCC and can be found under the Display Grant section of www.fcc.gov/oet/ea/fccid.

Handheld Devices

This device was tested for typical body worn operation. Use only Zebra tested and approved belt-clips, holsters, and similar accessories to ensure FCC Compliance. The use of third-party belt clips, holsters, and similar accessories may not comply with FCC RF exposure compliance requirements, and should be avoided.

To satisfy US and Canadian RF exposure requirements, a transmitting device must operate with a minimum separation distance of 0 cm or more from a person's body.

Pour satisfaire aux exigences Américaines et Canadiennes d'exposition aux radio fréquences, un dispositif de transmission doit fonctionner avec une distance de séparation minimale de 0 cm ou plus de corps d'une personne.

Laser Devices

LED Devices

Classified as 'EXEMPT RISK GROUP' according to IEC 62471:2006 and EN 62471:2008.

Pulse duration: CW.

Batteries

Taiwan - Recycling

EPA (Environmental Protection Administration) requires dry battery producing or importing firms in accordance with Article 15 of the Waste Disposal Act are required to indicate the recycling marks on the batteries used in sales, giveaway or promotion. Contact a qualified Taiwanese recycler for proper battery disposal.



「廢電池請回收」

Battery Information

 **CAUTION:** Risk of explosion if battery is replaced by an incorrect type. Dispose of batteries according to instructions.

Use only Zebra approved batteries. Accessories which have battery charging capability are approved for use with the following battery models:

- Model: AMME3735 (7.6V DC, 3,300 mAh) for 8.4" ET51AE, ET56BE
- Model: AMME3950 (7.7V DC, 4,950 mAh) for 10.1" ET51AT, ET56BT
- Model: BT-000381 (3.8V DC, 6,060 mAh) for 8.4" ET51CE, ET56DE
- Model: BT-000382 (3.8V DC, 8,760 mAh) for 10.1" ET51CT

Zebra approved rechargeable battery packs are designed and constructed to the highest standards within the industry.

However, there are limitations to how long a battery can operate or be stored before needing replacement. Many factors affect the actual life cycle of a battery pack, such as heat, cold, harsh environmental conditions and severe drops.

When batteries are stored over six (6) months, some irreversible deterioration in overall battery quality may occur. Store batteries at half of full charge in a dry, cool place, removed from the equipment to prevent loss of capacity, rusting of metallic parts and electrolyte leakage. When storing batteries for one year or longer, the charge level should be verified at least once a year and charged to half of full charge.

Replace the battery when a significant loss of run time is detected.

Standard warranty period for all Zebra batteries is one year, regardless if the battery was purchased separately or included as part of the mobile computer or bar code scanner. For more information on Zebra batteries, please visit: www.zebra.com/batterybasics.

Battery Safety Guidelines

The area in which the units are charged should be clear of debris and combustible materials or chemicals. Particular care should be taken where the device is charged in a non-commercial environment.

- Follow battery usage, storage, and charging guidelines found in the user's guide.
- Improper battery use may result in a fire, explosion, or other hazard.
- To charge the mobile device battery, the battery and charger temperatures must be between 32°F and +104°F (0°C and +40°C).
- Do not use incompatible batteries and chargers. Use of an incompatible battery or charger may present a risk of fire, explosion, leakage, or other hazard. If you have any questions about the compatibility of a battery or a charger, contact Zebra support.
- Do not disassemble or open, crush, bend or deform, puncture, or shred.
- Severe impact from dropping any battery-operated device on a hard surface could cause the battery to overheat.
- Do not short circuit a battery or allow metallic or conductive objects to contact the battery terminals.
- Do not modify or remanufacture, attempt to insert foreign objects into the battery, immerse or expose to water or other liquids, or expose to fire, explosion, or other hazard.
- Do not leave or store the equipment in or near areas that might get very hot, such as in a parked vehicle or near a radiator or other heat source. Do not place battery into a microwave oven or dryer.
- Battery usage by children should be supervised.
- Please follow local regulations to promptly dispose of used re-chargeable batteries.
- Do not dispose of batteries in fire.
- Seek medical advice immediately if a battery has been swallowed.

- In the event of a battery leak, do not allow the liquid to come in contact with the skin or eyes. If contact has been made, wash the affected area with large amounts of water and seek medical advice.
- If you suspect damage to your equipment or battery, contact Zebra support to arrange for inspection.

Removing the Battery

1. Lift the notched corner of the battery cover.

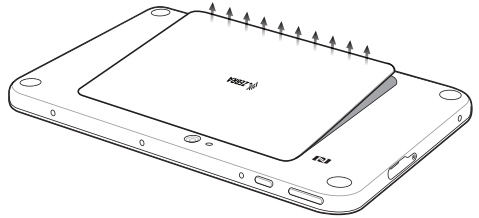
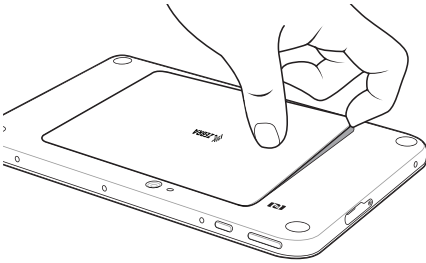

2. Carefully lift the battery cover off the device.
3. On the 8.4" version, push the two locking tabs up, then pull up on the tab to remove battery.

On the 10.1" version, push the two locking tabs up (1), then, using index fingers, lift the battery up (2).

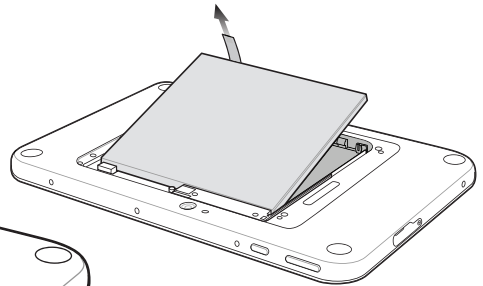
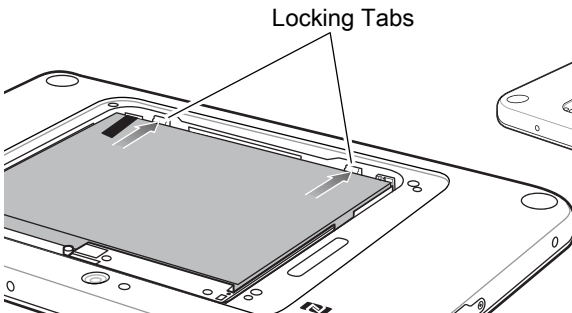

8.4" Version

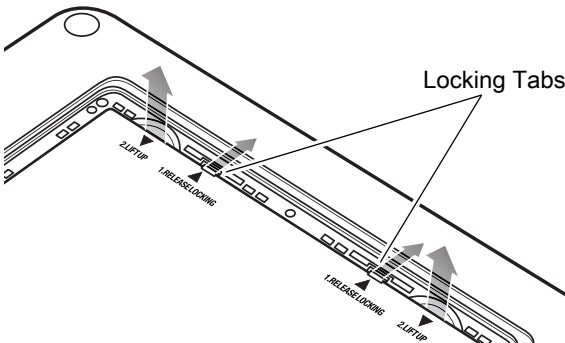

10.1" Version

Radio Frequency Interference Requirements-FCC

Note: This equipment has been tested and found to comply with the limits for a Class B digital device, pursuant to Part 15 of the FCC rules. These limits are designed to provide reasonable protection against harmful interference in a residential installation. This equipment generates, uses and can radiate radio frequency energy and, if not installed and used in accordance with the instructions, may cause harmful interference to radio communications. However there is no guarantee that interference will not occur in a particular installation. If this equipment does cause harmful interference to radio or television reception, which can be determined by turning the equipment off and on, the user is encouraged to try to correct the interference by one or more of the following measures:

- Reorient or relocate the receiving antenna
- Increase the separation between the equipment and receiver
- Connect the equipment into an outlet on a circuit different from that to which the receiver is connected
- Consult the dealer or an experienced radio/TV technician for help.

Radio Transmitters (Part 15)

This device complies with Part 15 of the FCC Rules. Operation is subject to the following two conditions: (1) this device may not cause harmful interference, and (2) this device must accept any interference received, including interference that may cause undesired operation.

Radio Frequency Interference Requirements - Canada

Innovation, Science and Economic Development Canada ICES-003 Compliance Label:
CAN ICES-3 (B)/NMB-3(B)

Radio Transmitters

This device complies with Industry Canada's licence-exempt RSSs. Operation is subject to the following two conditions: (1) This device may not cause interference; and (2) This device must accept any interference, including interference that may cause undesired operation of the device.

Le présent appareil est conforme aux CNR d'Industrie Canada applicables aux appareils radio exempts de licence. L'exploitation est autorisée aux deux conditions suivantes: (1) l'appareil ne doit pas produire de brouillage, et (2) l'utilisateur de l'appareil doit accepter tout brouillage radio électrique subi même si le brouillage est susceptible d'en compromettre le fonctionnement.

For RLAN Devices:

The use of 5 GHz RLAN in Canada has the following restriction:

- Restricted Band 5.60 - 5.65 GHz

Pour les équipements RLAN:

L'utilisation de la bande RLAN 5 GHz au Canada présente les limitations suivantes :

- Bande restreinte 5.60 - 5.65 GHz

Label Marking: The Term 'IC:' before the radio certification only signifies that Industry Canada technical specifications were met.

Etiquette de marquage: Le terme "IC" avant la certification radio signifie que le produit est compatible avec le spécification Industrie Canada

CE Marking and European Economic Area (EEA)

The use of 5 GHz RLAN throughout the EEA has the following restrictions:

- 5.15 - 5.35 GHz is restricted to indoor use only.

Statement of Compliance

Zebra hereby declares that this radio equipment is in compliance with Directives, 2014/53/EU and 2011/65/EU. The full text of the EU Declaration of Conformity is available at the following internet address: www.zebra.com/doc.

Japan (VCCI) - Voluntary Control Council for Interference

Class B ITE

この装置は、クラスB 情報技術装置です。この装置は、家庭環境で使用することを目的としていますが、この装置がラジオやテレビジョン受信機に近接して使用されると、受信障害を引き起こすことがあります。取扱説明書に従って正しい取り扱いをして下さい。
VCCI-B

Korea Warning Statement for Class B ITE

기종 별	사용자 안내문
B 급 기기 (가정용 방송통신기자재)	이 기기는 가정용 (B 급) 전자파적합기기로서 주로 가정에서 사용하는 것을 목적으로 하며, 모든 지역에서 사용할 수 있습니다.

Other Countries

Australia

Use of 5 GHz RLAN's in Australia is restricted in the following band 5.50 - 5.65GHz.

Chile

Este equipo cumple con la Resolución No 403 de 2008, de la Subsecretaria de telecomunicaciones, relativa a radiaciones electromagnéticas.

Conforme a Resolución 755 parte j.1), se ajustará el dispositivo a operar en interiores en las siguientes bandas con una potencia máxima radiada no superior a 150mW:

- 2.400 a 2.483,5 MHz
- 5.150 a 5.250MHz
- 5.250 a 5.350MHz
- 5.470 a 5.725MHz

- 5.725 a 5.850MHz

Además, de acuerdo con Resolución 755, para la banda 5150-5250MHz la operación del equipo estará restringida al interior de inmuebles y la densidad de potencia radiada máxima no supera 7,5mW/MHz en cualquier banda de 1MHz y 0.1875mW/25kHz en cualquier banda de 25kHz.

Para la tecnología NFC en la banda 13.553 a 13.567 kHz, la intensidad de campo eléctrico no excederá 20 mV/m a 30 metros, conforme a Resolución 755 parte Art 1. e).

China

通过访问以下网址可下载当地语言支持的产品说明书

www.zebra.com/support

锂电池安全警示语：

警告：请勿拆装，短路，撞击，挤压或者投入火中及水中；

注意：如果电池被不正确型号替换，或出现鼓胀，会存在爆炸及其他危险

请按说明处置使用过的电池

合格证：



Eurasian Customs Union

Евразийский Таможенный Союз

Данный продукт соответствует требованиям знака ЕАС.



Hong Kong

In accordance with HKTA1039, the band 5.15 GHz - 5.35 GHz is for indoor operation only.

Mexico

La operación de este equipo está sujeta a las siguientes dos condiciones: (1) es posible que este equipo o dispositivo no cause interferencia perjudicial y (2) este equipo o dispositivo debe aceptar cualquier interferencia, incluyendo la que pueda causar su operación no deseada.

South Korea

당해 무선설비는 운용 중 전파혼신 가능성이 있음

당해 무선설비는 전파혼신 가능성이 있으므로 인명안전과 관련된 서비스는 할 수 없습니다.

Taiwan

臺灣

低功率電波輻射性電機管理辦法

第十二條

經型式認證合格之低功率射頻電機，非經許可，公司、商號或使用者均不得擅自變更頻率、加大功率或變更原設計之特性及功能。

第十四條

低功率射頻電機之使用不得影響飛航安全及干擾合法通信；經發現有干擾現象時，應立即停用，並改善至無干擾時方得繼續使用。

前項合法通信，指依電信規定作業之無線電通信。

低功率射頻電機須忍受合法通信或工業、科學及醫療用電波輻射性電機設備之干擾。

應避免影響附近雷達系統之操作

減少電磁波影響，請妥適使用

台灣斑馬科技股份有限公司 / 台北市信義區松高路 9 號 13 樓

Thailand

เครื่องโทรคมนาคมและอุปกรณ์ นี้ มีความสอดคล้อง อกตามข้อกำหนดของ กททช .

Turkey

Bu cihaz Türkçe karakterlerin tamamını ihtiva eden ETSI TS 123.038 V8.0.0 (veya sonraki sürümünü kodu) ve ETSI TS 123.040 V8.1.0 (veya sonraki sürümünü kodu) teknik özelliklerine uygundur.

Ukraine

Дане обладнання відповідає вимогам технічного регламенту № 1057, 2008 на обмеження щодо використання деяких небезпечних речовин в електричних та електронних пристроях.



Waste Electrical and Electronic Equipment (WEEE)

English: For EU Customers: All products at the end of their life must be returned to Zebra for recycling. For information on how to return product, please go to:

www.zebra.com/weee.

Français: Clients de l'Union Européenne: Tous les produits en fin de cycle de vie doivent être retournés à Zebra pour recyclage. Pour de plus amples informations sur le retour de produits, consultez : www.zebra.com/weee.

Español: Para clientes en la Unión Europea: todos los productos deberán entregarse a Zebra al final de su ciclo de vida para que sean reciclados. Si desea más información sobre cómo devolver un producto, visite: www.zebra.com/weee.

Bulgarian: За клиенти от ЕС: След края на полезния им живот всички продукти трябва да се връщат на Zebra за рециклиране. За информация относно връщането на продукти, моля отидете на адрес: www.zebra.com/weee.

Deutsch: Für Kunden innerhalb der EU: Alle Produkte müssen am Ende ihrer Lebensdauer zum Recycling an Zebra zurückgesandt werden. Informationen zur Rücksendung von Produkten finden Sie unter www.zebra.com/weee.

Italiano: per i clienti dell'UE: tutti i prodotti che sono giunti al termine del rispettivo ciclo di vita devono essere restituiti a Zebra al fine di consentirne il riciclaggio. Per informazioni sulle modalità di restituzione, visitare il seguente sito Web: www.zebra.com/weee.

Português: Para clientes da UE: todos os produtos no fim de vida devem ser devolvidos à Zebra para reciclagem. Para obter informações sobre como devolver o produto, visite: www.zebra.com/weee.

Nederlands: Voor klanten in de EU: alle producten dienen aan het einde van hun levensduur naar Zebra te worden teruggezonden voor recycling. Raadpleeg www.zebra.com/weee voor meer informatie over het terugzenden van producten.

Polski: Klienci z obszaru Unii Europejskiej: Produkty wycofane z eksploatacji należy zwrócić do firmy Zebra w celu ich utylizacji. Informacje na temat zwrotu produktów znajdują się na stronie internetowej www.zebra.com/weee.

Čeština: Pro zákazníky z EU: Všechny produkty je nutné po skončení jejich životnosti vrátit společnosti Zebra k recyklaci. Informace o způsobu vrácení produktu najdete na webové stránce: www.zebra.com/weee.

Eesti: EL klientidele: kõik tooted tuleb nende eluea lõppedes tagastada taaskasutamise eesmärgil Zebra'ile. Lisainformatsiooni saamiseks toote tagastamise kohta külastage palun aadressi: www.zebra.com/weee.

Magyar: Az EU-ban vásárlóknak: Minden tönkrement termékét a Zebra vállalathoz kell eljuttatni újrahasznosítás céljából. A termék visszajuttatásának módjával kapcsolatos tudnivalóért látogasson el a www.zebra.com/weee weboldalra.

Svenska: För kunder inom EU: Alla produkter som uppnått sin livslängd måste returneras till Zebra för återvinning. Information om hur du returnerar produkten finns på www.zebra.com/weee.

Suomi: Asiakkaat Euroopan unionin alueella: Kaikki tuotteet on palautettava kierrätettäväksi Zebra-yhtiöön, kun tuotetta ei enää käytetä. Lisätietoja tuotteen palauttamisesta on osoitteessa www.zebra.com/weee.

Dansk: Til kunder i EU: Alle produkter skal returneres til Zebra til recirkulering, når de er udtjent. Læs oplysningerne om returnering af produkter på: www.zebra.com/weee.

Ελληνικά: Για πελάτες στην Ε.Ε.: Όλα τα προϊόντα, στο τέλος της διάρκειας ζωής τους, πρέπει να επιστρέφονται στην Zebra για ανακύκλωση. Για περισσότερες πληροφορίες σχετικά με την επιστροφή ενός προϊόντος, επισκεφθείτε τη διεύθυνση www.zebra.com/weee στο Διαδίκτυο.

Malti: Għal klijenti fl-UE: il-prodotti kollha li jkunu waslu fl-aħħar tal-ħajja ta' l-użu tagħhom, iridu jġu rritornati għand Zebra għar-riċiklaġġ. Għal aktar tagħrif dwar kif għandek tiritorna l-prodott, jekk jogħġbok żur: www.zebra.com/weee.

Românesc: Pentru clienții din UE: Toate produsele, la sfârșitul duratei lor de funcționare, trebuie returnate la Zebra pentru reciclare. Pentru informații despre returnarea produsului, accesați: www.zebra.com/weee.

Slovenski: Za kupce v EU: vsi izdelki se morajo po poteku življenjske dobe vrniti podjetju Zebra za reciklažo. Za informacije o vračilu izdelka obiščite: www.zebra.com/weee.

Slovenčina: Pre zákazníkov z krajín EU: Všetky výrobky musia byť po uplynutí doby ich životnosti vrátené spoločnosti Zebra na recykláciu. Bližšie informácie o vrátení výrobkov nájdete na: www.zebra.com/weee.

Lietuvių: ES vartotojams: visi gaminiai, pasibaigus jų eksploatacijos laikui, turi būti gražinti utilizuoti į kompaniją „Zebra“. Daugiau informacijos, kaip gražinti gaminį, rasite: www.zebra.com/weee.

Latviešu: ES klientiem: visi produkti pēc to kalpošanas mūža beigām ir jānogādā atpakaļ Zebra atreizējai pārstrādei. Lai iegūtu informāciju par produktu nogādāšanu Zebra, lūdzu, skatiet: www.zebra.com/weee.

Türkçe: AB Müşterileri için: Kullanım süresi dolan tüm ürünler geri dönüştürme için Zebra'ya iade edilmelidir. Ürünlerin nasıl iade edileceği hakkında bilgi için lütfen şu adresi ziyaret edin: www.zebra.com/weee.

Turkish WEEE Statement of Compliance

EEE Yönetmeliğine Uygundur.

Software Support

Zebra wants to ensure that customers have the latest release of entitled software at the time of product purchase.

To confirm that your Zebra device shipped with the latest release of entitled software, visit: www.zebra.com/support. Check for the latest software from Software Downloads > Product Line/Product > Go.

If your device does not have the latest entitled software release as of your product purchase date, please e-mail a request to Zebra at: entitlementservices@zebra.com.

You must include the following essential device information with your request:

- Model number
- Serial number
- Proof of purchase
- Title of the software download you are requesting.

If it is determined by Zebra that your device is entitled to the latest software release, you will receive an e-mail containing a link directing you to a Zebra web site to download the appropriate software.

CMM Disclosure

部件名称 (Parts)	有害物质					
	铅 (Pb)	汞 (Hg)	镉 (Cd)	六价铬 (Cr(VI))	多溴联苯 (PBB)	多溴二苯醚 (PBDE)
金属部件 (Metal Parts)	X	O	X	O	O	O
电路模块 (Circuit Modules)	X	O	O	O	O	O
电缆及电缆组件 (Cables and Cable Assemblies)	O	O	O	O	O	O
塑料和聚合物部件 (Plastic and Polymeric Parts)	O	O	O	O	O	O
光学和光学组件 (Optics and Optical Components)	O	O	O	O	O	O
电池 (Batteries)	X	O	O	O	O	O

本表格依据 SJ/T 11364 的规定编制。

O: 表示该有害物质在该部件所有均质材料中的含量均在 GB/T 26572 规定的限量要求以下。
X: 表示该有害物质至少在该部件的某一均质材料中的含量超出 GB/T 26572 规定的限量要求。(企业可在此处, 根据实际情况对上表中打“x”的技术原因进行进一步说明。)

This table was created to comply with China RoHS requirements.

限用物質含有情況標示聲明書

設備名稱：平板電腦 Equipment name		型號 (型式) : ET51AE, ET51AT, ET51CE, ET51CT, ET56BE, ET56BT, ET56DE Type designation (Type)				
單元 Unit	限用物質及其化學符號 Restricted substances and its chemical symbols					
	鉛 (Pb)	汞 (Hg)	鎘 (Cd)	六價鉻 (Cr ⁺⁶)	多溴聯苯 (PBB)	多溴二苯醚 (PBDE)
印刷電路板及電子組件	-	O	O	O	O	O
金屬零件	-	O	-	O	O	O
電纜及電纜組件	O	O	O	O	O	O
塑料和聚合物零件	O	O	O	O	O	O
光學與光學元件	O	O	O	O	O	O

備考 1. “超出 0.1 wt %” 及 “超出 0.01 wt %” 係指限用物質之百分比含量超出百分比含量基準值。

Note 1: “Exceeding 0.1 wt%” and “exceeding 0.01 wt%” indicate that the percentage content of the restricted substance exceeds the reference percentage value of presence condition.

備考 2. “O” 係指該項限用物質之百分比含量未超出百分比含量基準值。

Note 2: “O” indicates that the percentage content of the restricted substance does not exceed the percentage of reference value of presence.

備考 3. “-” 係指該項限用物質為排除項目。

Note 3: The “-” indicates that the restricted substance corresponds to the exemption.



www.zebra.com

