

# OptiPlex 7000 Micro

## Service Manual

## Notes, cautions, and warnings

 **NOTE:** A NOTE indicates important information that helps you make better use of your product.

 **CAUTION:** A CAUTION indicates either potential damage to hardware or loss of data and tells you how to avoid the problem.

 **WARNING:** A WARNING indicates a potential for property damage, personal injury, or death.

<b>Chapter 1: Working inside your computer</b> .....	<b>5</b>
Safety instructions.....	5
Before working inside your computer.....	5
Safety precautions.....	6
Electrostatic discharge—ESD protection.....	6
ESD field service kit .....	7
Transporting sensitive components.....	8
After working inside your computer.....	8
BitLocker.....	8
<b>Chapter 2: Removing and installing components</b> .....	<b>9</b>
Recommended tools.....	9
Screw list.....	9
Major components of OptiPlex 7000 Micro.....	10
Side cover.....	11
Removing the side cover.....	11
Installing the side cover.....	12
Front bezel.....	14
Removing the front bezel.....	14
Installing the front bezel.....	15
Solid-state drive.....	16
Removing the M.2 2230 PCIe solid-state drive.....	16
Installing the M.2 2230 PCIe solid-state drive.....	17
Removing the M.2 2280 PCIe solid-state drive.....	19
Installing the M.2 2280 PCIe solid-state drive.....	20
WLAN card.....	21
Removing the WLAN card.....	21
Installing the WLAN card.....	22
Fan assembly.....	24
Removing the fan assembly.....	24
Installing the fan assembly.....	25
Heat sink.....	27
Removing the heat sink.....	27
Installing the heat sink.....	28
Coin-cell battery.....	29
Removing the coin-cell battery.....	29
Installing the coin-cell battery.....	29
Memory modules.....	30
Removing the memory modules.....	30
Installing the memory modules.....	31
Optional I/O modules (Type C/HDMI/VGA/DP/Serial).....	35
Removing optional I/O modules (Type C/HDMI/VGA/DP/Serial).....	35
Installing optional I/O modules (Type C/HDMI/VGA/DP/Serial).....	36
Speaker.....	38











Removing the speaker.....	38
Installing the speaker.....	39
Processor.....	40
Removing the processor.....	40
Installing the processor.....	41
Internal Antenna.....	43
Removing internal antenna (Location 1).....	43
Installing internal antenna (Location 1).....	44
Removing internal antenna (Location 3).....	45
Installing internal antenna (Location 3).....	47
Removing SMA antenna (Location 3).....	48
Installing SMA antenna (Location 3).....	49
System board.....	51
Removing the system board.....	51
Installing the system board.....	54
<b>Chapter 3: Drivers and downloads.....</b>	<b>57</b>
<b>Chapter 4: BIOS setup.....</b>	<b>58</b>
Entering BIOS setup program.....	58
Navigation keys.....	58
One time boot menu.....	58
System setup options.....	59
Updating the BIOS.....	68
Updating the BIOS in Windows.....	68
Updating the BIOS in Linux and Ubuntu.....	68
Updating the BIOS using the USB drive in Windows.....	68
Updating the BIOS from the F12 One-Time boot menu.....	69
System and setup password.....	69
Assigning a system setup password.....	70
Deleting or changing an existing system setup password.....	70
Clearing BIOS (System Setup) and System passwords.....	71
<b>Chapter 5: Troubleshooting.....</b>	<b>72</b>
Dell SupportAssist Pre-boot System Performance Check diagnostics.....	72
Running the SupportAssist Pre-Boot System Performance Check.....	72
Power-Supply Unit Built-in Self-Test .....	72
System-diagnostic lights.....	73
Recovering the operating system.....	74
Real Time Clock—RTC reset.....	74
Backup media and recovery options.....	75
WiFi power cycle.....	75
<b>Chapter 6: Getting help and contacting Dell.....</b>	<b>76</b>



# Working inside your computer



## Safety instructions

Use the following safety guidelines to protect your computer from potential damage and to ensure your personal safety. Unless otherwise noted, each procedure included in this document assumes that you have read the safety information that shipped with your computer.

-  **WARNING:** Before working inside your computer, read the safety information that is shipped with your computer. For more safety best practices, see the Regulatory Compliance home page at [www.dell.com/regulatory\\_compliance](http://www.dell.com/regulatory_compliance).
-  **WARNING:** Disconnect your computer from all power sources before opening the computer cover or panels. After you finish working inside the computer, replace all covers, panels, and screws before connecting your computer to an electrical outlet.
-  **CAUTION:** To avoid damaging the computer, ensure that the work surface is flat, dry, and clean.
-  **CAUTION:** To avoid damaging the components and cards, handle them by their edges, and avoid touching the pins and the contacts.
-  **CAUTION:** You should only perform troubleshooting and repairs as authorized or directed by the Dell technical assistance team. Damage due to servicing that is not authorized by Dell is not covered by your warranty. See the safety instructions that is shipped with the product or at [www.dell.com/regulatory\\_compliance](http://www.dell.com/regulatory_compliance).
-  **CAUTION:** Before touching anything inside your computer, ground yourself by touching an unpainted metal surface, such as the metal at the back of the computer. While you work, periodically touch an unpainted metal surface to dissipate static electricity which could harm internal components.
-  **CAUTION:** When you disconnect a cable, pull it by its connector or its pull tab, not the cable itself. Some cables have connectors with locking tabs or thumbscrews that you must disengage before disconnecting the cable. When disconnecting cables, keep them evenly aligned to avoid bending the connector pins. When connecting cables, ensure that the ports and the connectors are correctly oriented and aligned.
-  **CAUTION:** Press and eject any installed card from the media-card reader.
-  **CAUTION:** Exercise caution when handling Lithium-ion batteries in laptops. Swollen batteries should not be used and should be replaced and disposed properly.
-  **NOTE:** The color of your computer and certain components may appear differently than shown in this document.

## Before working inside your computer

### Steps

1. Save and close all open files and exit all open applications.
2. Shut down your computer. Click **Start** >  **Power** > **Shut down**.
  -  **NOTE:** If you are using a different operating system, see the documentation of your operating system for shut-down instructions.
3. Disconnect your computer and all attached devices from their electrical outlets.
4. Disconnect all attached network devices and peripherals, such as keyboard, mouse, and monitor from your computer.

5. Remove any media card and optical disc from your computer, if applicable.
6. Place the computer face down.

 **CAUTION: Place the computer on a flat, soft, and clean surface to avoid scratches on the display.**

## Safety precautions

The safety precautions chapter details the primary steps to be taken before performing any disassembly instructions.

Observe the following safety precautions before you perform any installation or break/fix procedures involving disassembly or reassembly:

- Turn off the system and all attached peripherals.
- Disconnect the system and all attached peripherals from AC power.
- Disconnect all network cables, telephone, and telecommunications lines from the system.
- Use an ESD field service kit when working inside any desktop to avoid electrostatic discharge (ESD) damage.
- After removing any system component, carefully place the removed component on an anti-static mat.
- Wear shoes with non-conductive rubber soles to reduce the chance of getting electrocuted.

## Standby power

Dell products with standby power must be unplugged before you open the case. Systems that incorporate standby power are essentially powered while turned off. The internal power enables the system to be remotely turned on (wake on LAN) and suspended into a sleep mode and has other advanced power management features.

Unplugging, pressing and holding the power button for 15 seconds should discharge residual power in the system board.

## Bonding

Bonding is a method for connecting two or more grounding conductors to the same electrical potential. This is done through the use of a field service electrostatic discharge (ESD) kit. When connecting a bonding wire, ensure that it is connected to bare metal and never to a painted or non-metal surface. The wrist strap should be secure and in full contact with your skin, and ensure that you remove all jewelry such as watches, bracelets, or rings prior to bonding yourself and the equipment.

## Electrostatic discharge—ESD protection

ESD is a major concern when you handle electronic components, especially sensitive components such as expansion cards, processors, memory DIMMs, and system boards. Very slight charges can damage circuits in ways that may not be obvious, such as intermittent problems or a shortened product life span. As the industry pushes for lower power requirements and increased density, ESD protection is an increasing concern.

Due to the increased density of semiconductors used in recent Dell products, the sensitivity to static damage is now higher than in previous Dell products. For this reason, some previously approved methods of handling parts are no longer applicable.

Two recognized types of ESD damage are catastrophic and intermittent failures.

- **Catastrophic** – Catastrophic failures represent approximately 20 percent of ESD-related failures. The damage causes an immediate and complete loss of device functionality. An example of catastrophic failure is a memory DIMM that has received a static shock and immediately generates a "No POST/No Video" symptom with a beep code emitted for missing or nonfunctional memory.
- **Intermittent** – Intermittent failures represent approximately 80 percent of ESD-related failures. The high rate of intermittent failures means that most of the time when damage occurs, it is not immediately recognizable. The DIMM receives a static shock, but the tracing is merely weakened and does not immediately produce outward symptoms related to the damage. The weakened trace may take weeks or months to melt, and in the meantime may cause degradation of memory integrity, intermittent memory errors, etc.

The more difficult type of damage to recognize and troubleshoot is the intermittent (also called latent or "walking wounded") failure.

Perform the following steps to prevent ESD damage:

- Use a wired ESD wrist strap that is properly grounded. The use of wireless anti-static straps is no longer allowed; they do not provide adequate protection. Touching the chassis before handling parts does not ensure adequate ESD protection on parts with increased sensitivity to ESD damage.
- Handle all static-sensitive components in a static-safe area. If possible, use anti-static floor pads and workbench pads.
- When unpacking a static-sensitive component from its shipping carton, do not remove the component from the anti-static packing material until you are ready to install the component. Before unwrapping the anti-static packaging, ensure that you discharge static electricity from your body.
- Before transporting a static-sensitive component, place it in an anti-static container or packaging.

## ESD field service kit

The unmonitored Field Service kit is the most commonly used service kit. Each Field Service kit includes three main components: anti-static mat, wrist strap, and bonding wire.

### Components of an ESD field service kit

The components of an ESD field service kit are:

- **Anti-Static Mat** – The anti-static mat is dissipative and parts can be placed on it during service procedures. When using an anti-static mat, your wrist strap should be snug and the bonding wire should be connected to the mat and to any bare metal on the system being worked on. Once deployed properly, service parts can be removed from the ESD bag and placed directly on the mat. ESD-sensitive items are safe in your hand, on the ESD mat, in the system, or inside a bag.
- **Wrist Strap and Bonding Wire** – The wrist strap and bonding wire can be either directly connected between your wrist and bare metal on the hardware if the ESD mat is not required, or connected to the anti-static mat to protect hardware that is temporarily placed on the mat. The physical connection of the wrist strap and bonding wire between your skin, the ESD mat, and the hardware is known as bonding. Use only Field Service kits with a wrist strap, mat, and bonding wire. Never use wireless wrist straps. Always be aware that the internal wires of a wrist strap are prone to damage from normal wear and tear, and must be checked regularly with a wrist strap tester in order to avoid accidental ESD hardware damage. It is recommended to test the wrist strap and bonding wire at least once per week.
- **ESD Wrist Strap Tester** – The wires inside of an ESD strap are prone to damage over time. When using an unmonitored kit, it is a best practice to regularly test the strap prior to each service call, and at a minimum, test once per week. A wrist strap tester is the best method for doing this test. If you do not have your own wrist strap tester, check with your regional office to find out if they have one. To perform the test, plug the wrist-strap's bonding-wire into the tester while it is strapped to your wrist and push the button to test. A green LED is lit if the test is successful; a red LED is lit and an alarm sounds if the test fails.
- **Insulator Elements** – It is critical to keep ESD sensitive devices, such as plastic heat sink casings, away from internal parts that are insulators and often highly charged.
- **Working Environment** – Before deploying the ESD Field Service kit, assess the situation at the customer location. For example, deploying the kit for a server environment is different than for a desktop or portable environment. Servers are typically installed in a rack within a data center; desktops or portables are typically placed on office desks or cubicles. Always look for a large open flat work area that is free of clutter and large enough to deploy the ESD kit with additional space to accommodate the type of system that is being repaired. The workspace should also be free of insulators that can cause an ESD event. On the work area, insulators such as Styrofoam and other plastics should always be moved at least 12 inches or 30 centimeters away from sensitive parts before physically handling any hardware components
- **ESD Packaging** – All ESD-sensitive devices must be shipped and received in static-safe packaging. Metal, static-shielded bags are preferred. However, you should always return the damaged part using the same ESD bag and packaging that the new part arrived in. The ESD bag should be folded over and taped shut and all the same foam packing material should be used in the original box that the new part arrived in. ESD-sensitive devices should be removed from packaging only at an ESD-protected work surface, and parts should never be placed on top of the ESD bag because only the inside of the bag is shielded. Always place parts in your hand, on the ESD mat, in the system, or inside an anti-static bag.
- **Transporting Sensitive Components** – When transporting ESD sensitive components such as replacement parts or parts to be returned to Dell, it is critical to place these parts in anti-static bags for safe transport.

### ESD protection summary

It is recommended that all field service technicians use the traditional wired ESD grounding wrist strap and protective anti-static mat at all times when servicing Dell products. In addition, it is critical that technicians keep sensitive parts separate from all insulator parts while performing service and that they use anti-static bags for transporting sensitive components.

## Transporting sensitive components

When transporting ESD sensitive components such as replacement parts or parts to be returned to Dell, it is critical to place these parts in anti-static bags for safe transport.

## Lifting equipment

Adhere to the following guidelines when lifting heavy weight equipment:

 **CAUTION: Do not lift greater than 50 pounds. Always obtain additional resources or use a mechanical lifting device.**

1. Get a firm balanced footing. Keep your feet apart for a stable base, and point your toes out.
2. Tighten stomach muscles. Abdominal muscles support your spine when you lift, offsetting the force of the load.
3. Lift with your legs, not your back.
4. Keep the load close. The closer it is to your spine, the less force it exerts on your back.
5. Keep your back upright, whether lifting or setting down the load. Do not add the weight of your body to the load. Avoid twisting your body and back.
6. Follow the same techniques in reverse to set the load down.

## After working inside your computer

### About this task

 **NOTE:** Leaving stray or loose screws inside your computer may severely damage your computer.

### Steps

1. Replace all screws and ensure that no stray screws remain inside your computer.
2. Connect any external devices, peripherals, or cables you removed before working on your computer.
3. Replace any media cards, discs, or any other parts that you removed before working on your computer.
4. Connect your computer and all attached devices to their electrical outlets.
5. Turn on your computer.

## BitLocker

 **CAUTION: If BitLocker is not suspended before updating the BIOS, the next time you reboot the system it will not recognize the BitLocker key. You will then be prompted to enter the recovery key to progress, and the system will ask for this on each reboot. If the recovery key is not known this can result in data loss or an unnecessary operating system reinstall. For more information about this subject, see Knowledge Article: [updating the BIOS on Dell systems with BitLocker enabled](#).**

The installation of the following components triggers BitLocker:

- Hard disk drive or solid state drive
- System board

# Removing and installing components

**NOTE:** The images in this document may differ from your computer depending on the configuration you ordered.

## Recommended tools

The procedures in this document may require the following tools:

- Phillips screwdriver #0
- Phillips screwdriver #1
- Plastic scribe





## Screw list

**NOTE:** When removing screws from a component, it is recommended to note the screw type, the quantity of screws, and then place them in a screw storage box. This is to ensure that the correct number of screws and correct screw type is restored when the component is replaced.

**NOTE:** Some computers have magnetic surfaces. Ensure that the screws are not left attached to such surfaces when replacing a component.

**NOTE:** Screw color may vary with the configuration ordered.

**Table 1. Screw list**

Component	Screw type	Quantity	Image
Side cover	#6-32 (Captive screws)	1	
System board	M3x5 M3x4L	5 3	
Heat sink	M3x25 (Captive screws)	3	
WLAN card	M2x3.5	1	
M.2 2230/2280 Solid-state drive	M2x3.5	2	
Internal Antenna	M3x3MM	3	

# Major components of OptiPlex 7000 Micro

The following image shows the major components of OptiPlex 7000 Micro.

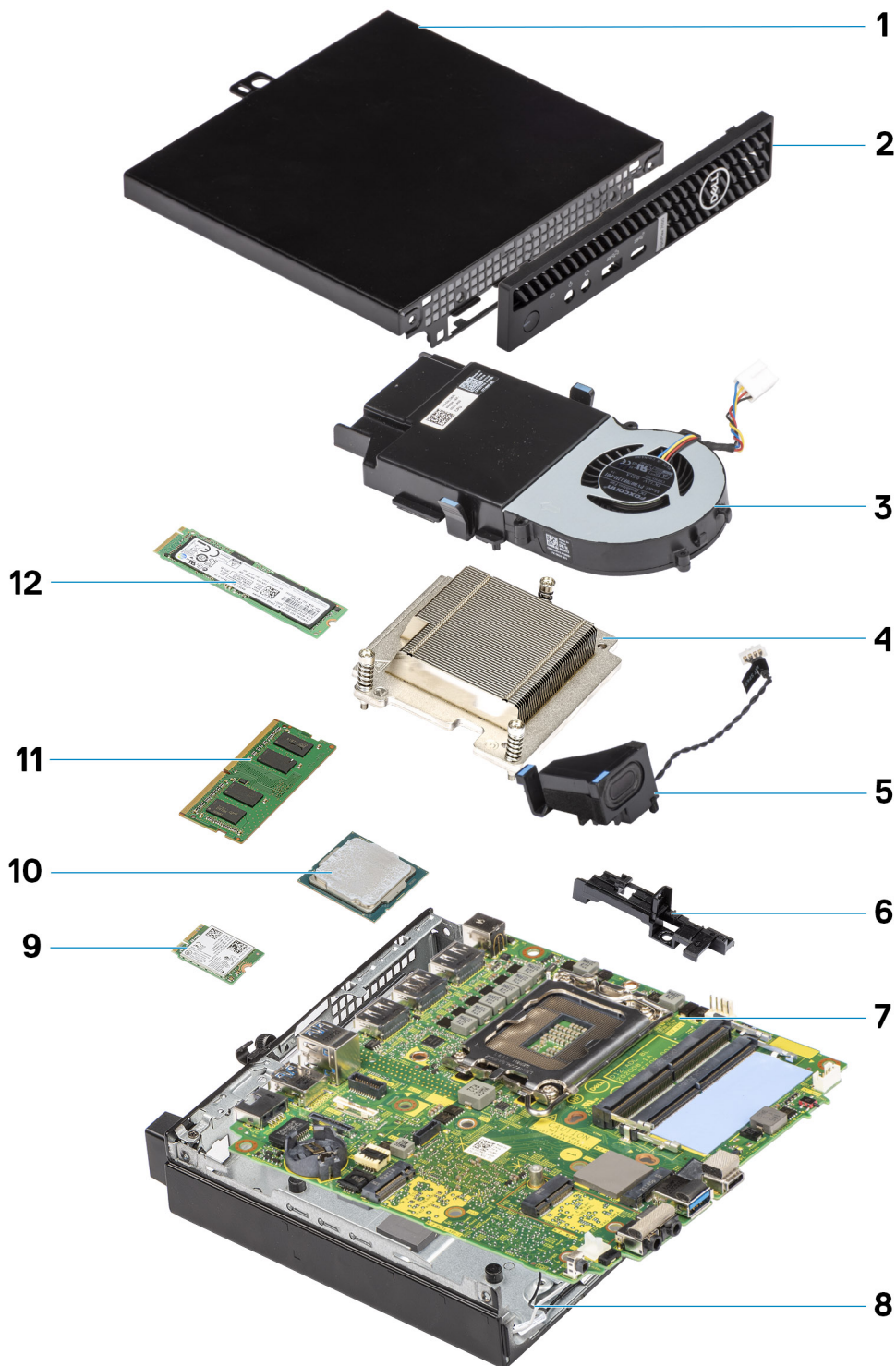

1. Side cover
3. Fan assembly
5. Speaker
7. System board
9. WLAN card

2. Front bezel
4. Heat sink
6. Speaker holder
8. Chassis
10. Processor

**NOTE:** Dell provides a list of components and their part numbers for the original system configuration purchased. These parts are available according to warranty coverages purchased by the customer. Contact your Dell sales representative for purchase options.

## Side cover

### Removing the side cover

#### Prerequisites

1. Follow the procedure in [before working inside your computer](#).

**NOTE:** Ensure that you remove the security cable from the security-cable slot (if applicable).

#### About this task

The following images indicate the location of the side cover and provide a visual representation of the removal procedure.



1x  
6x32





2



### Steps

1. Loosen the thumbscrew (6x32) that secures the side cover to the system.
2. Slide the side cover towards the front of the system and lift the cover.

## Installing the side cover

### Prerequisites

If you are replacing a component, remove the existing component before performing the installation procedure.

### About this task

The following image indicates the location of the side cover and provides a visual representation of the installation procedure.



1



1x  
6x32

2



### Steps

1. Align the side cover with the grooves on the chassis.
2. Slide the side cover towards the back of the system to install it.
3. Tighten the thumbscrew (6x32) to secure the side cover to the system.

### Next steps

1. Follow the procedure in [after working inside your computer](#).

## Front bezel

### Removing the front bezel

#### Prerequisites

1. Follow the procedure in [before working inside your computer](#).
2. Remove the [side cover](#).

#### About this task

The following images indicate the location of the front bezel and provide a visual representation of the removal procedure.

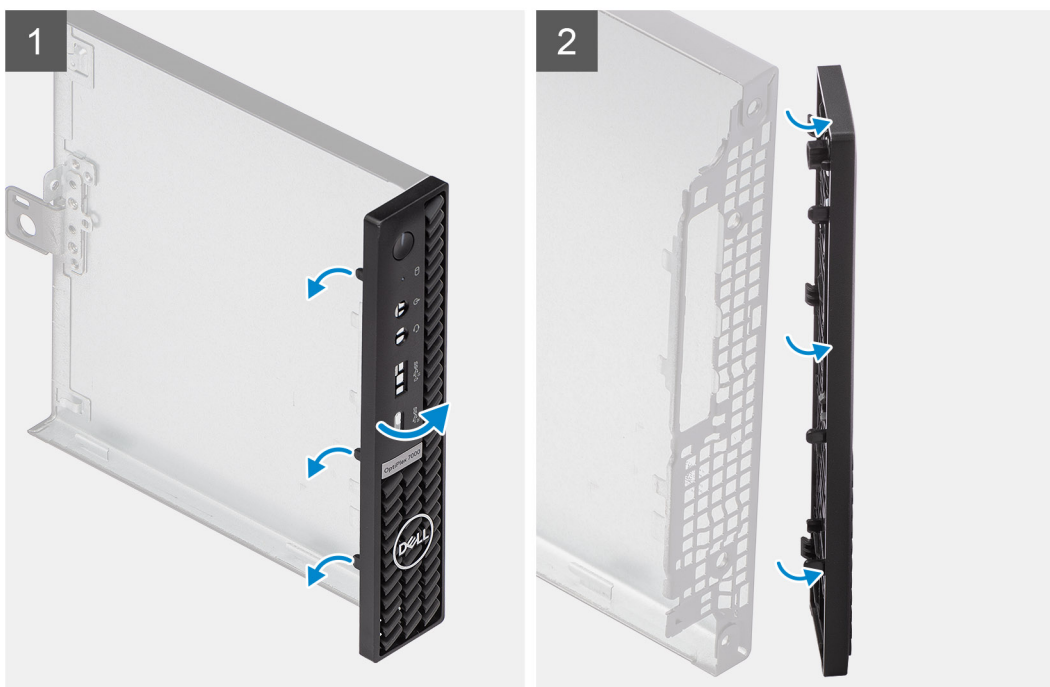

### Steps

1. Pry the retention tabs to release the front bezel from the system.

2. Remove the front bezel from the system.

## Installing the front bezel

### Prerequisites

If you are replacing a component, remove the existing component before performing the installation procedure.

### About this task

The following image indicates the location of the front bezel and provides a visual representation of the installation procedure.

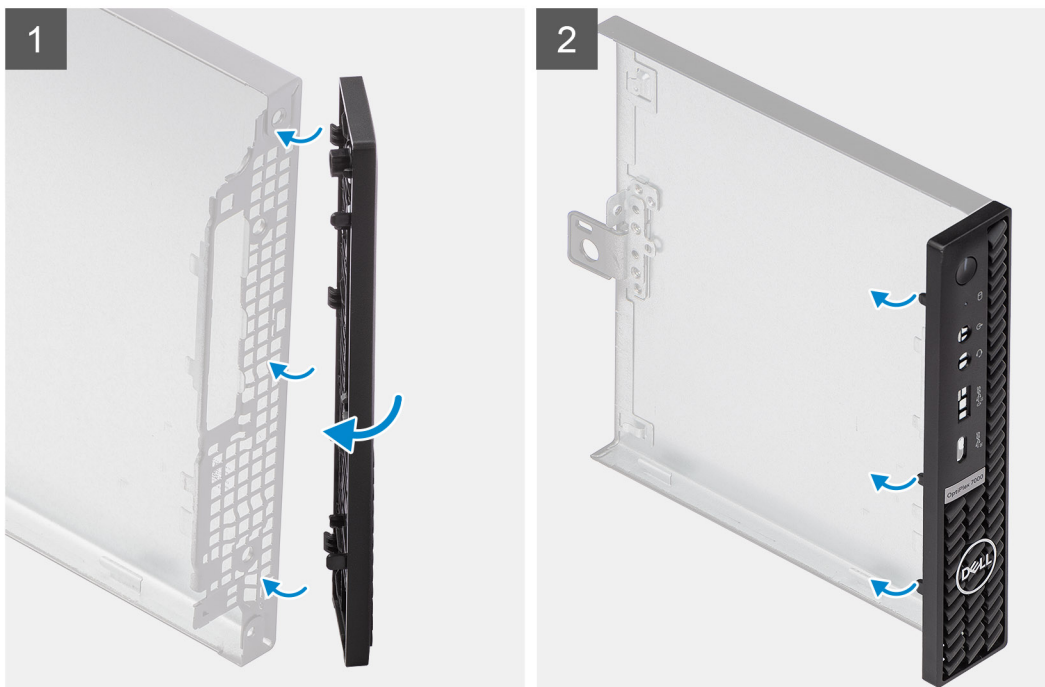
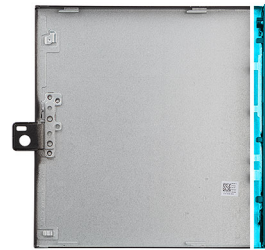

### Steps

1. Position the bezel to align the tabs with the slots on the chassis.
2. Press the bezel until the release tabs click into place.

### Next steps

1. Install the [side cover](#).
2. Follow the procedure in [after working inside your computer](#).

# Solid-state drive

## Removing the M.2 2230 PCIe solid-state drive

### Prerequisites

1. Follow the procedure in [before working inside your computer](#).
2. Remove the [side cover](#).

### About this task

The following images indicate the location of the solid-state drive and provide a visual representation of the removal procedure.



**1x**  
M2x3.5

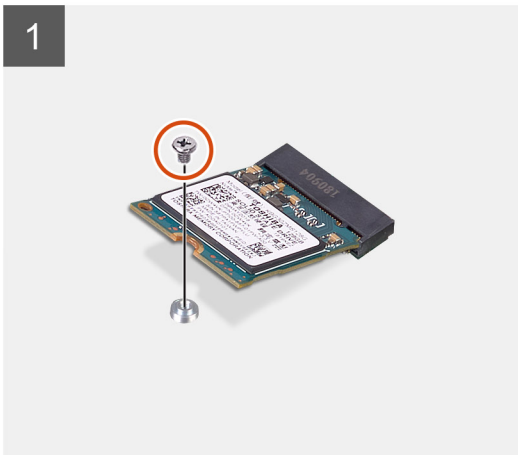
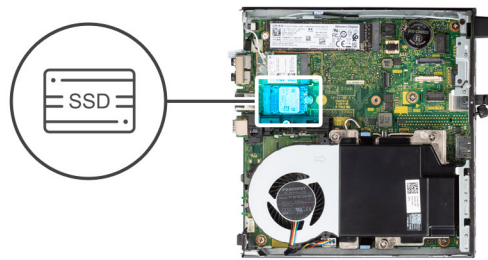



1x  
M2x3.5

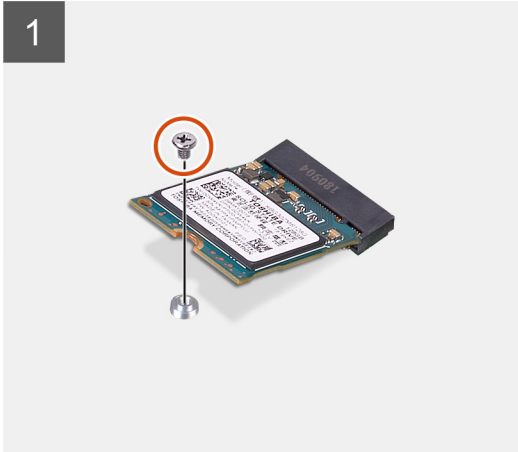
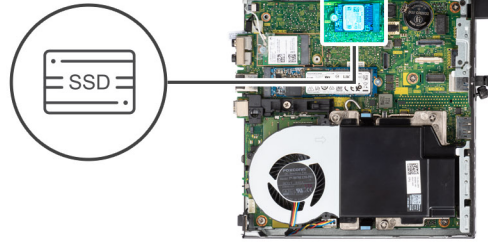

### Steps

1. Remove the screw (M2x3.5) that secures the solid-state drive to the system board.

**i** NOTE: The system has two solid-state drive slots.

2. Slide and lift the solid-state drive off the system board.

## Installing the M.2 2230 PCIe solid-state drive

### Prerequisites

If you are replacing a component, remove the existing component before performing the installation procedure.

### About this task

The following image indicates the location of the solid-state drive and provides a visual representation of the installation procedure.



1x  
M2x3.5

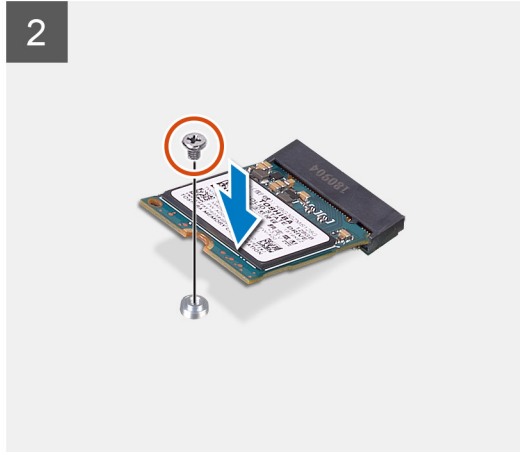
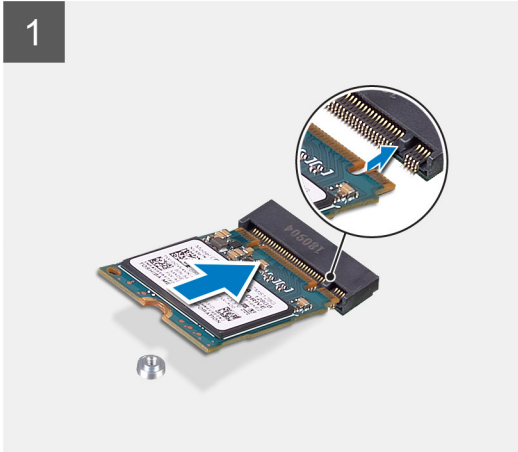
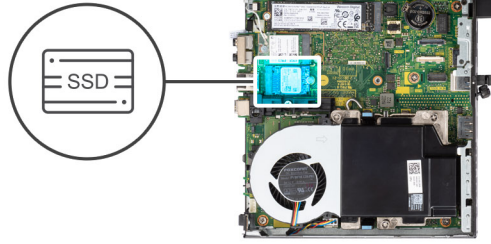

1x  
M2x3.5

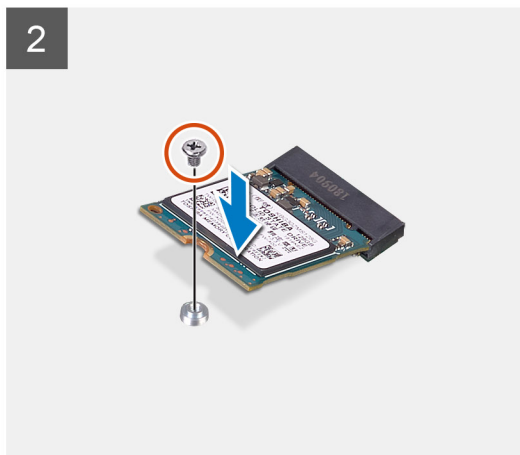
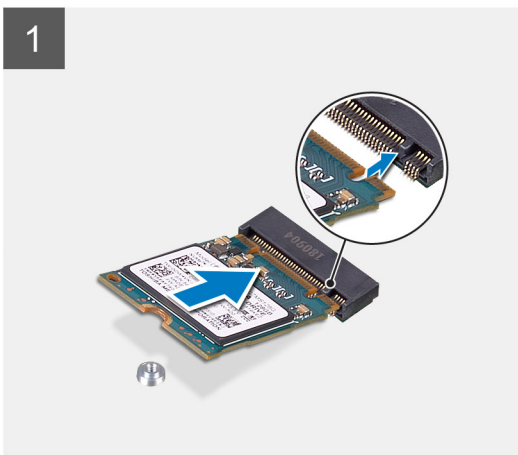
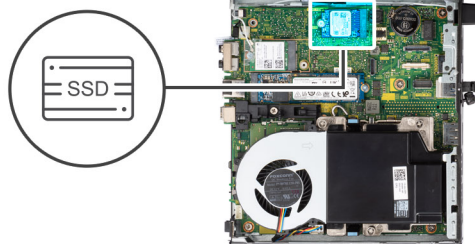

### Steps

1. Align the notch on the solid-state drive with the tab on the solid-state drive connector on the system board.
2. Insert the solid-state drive at a 45-degree angle into the solid-state drive connector.
3. Replace the screw (M2x3.5) that secures the M.2 2230 PCIe solid-state drive to the system board.

### Next steps

1. Install the [side cover](#).
2. Follow the procedure in [after working inside your computer](#).

# Removing the M.2 2280 PCIe solid-state drive

## Prerequisites

1. Follow the procedure in [before working inside your computer](#).
2. Remove the [side cover](#).

## About this task

The following images indicate the location of the solid-state drive and provide a visual representation of the removal procedure.



1x  
M2x3.5

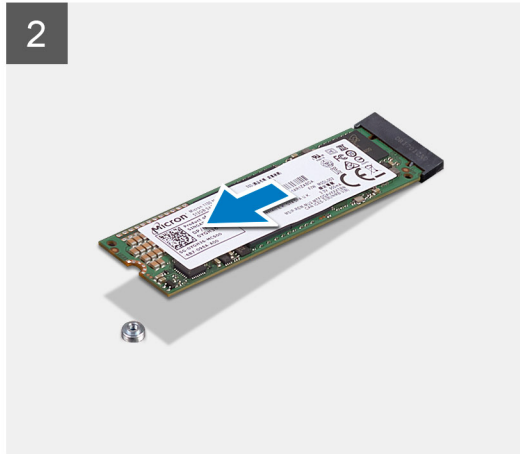
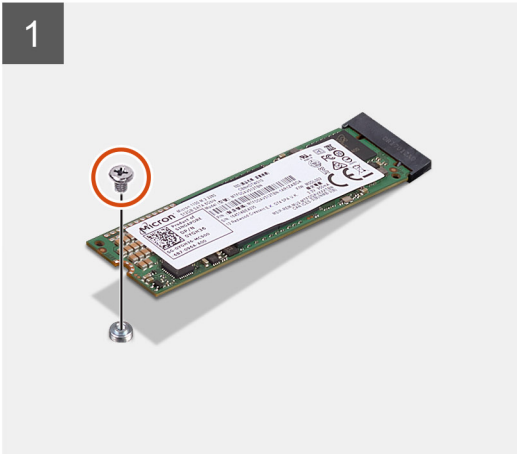

1x  
M2x3.5

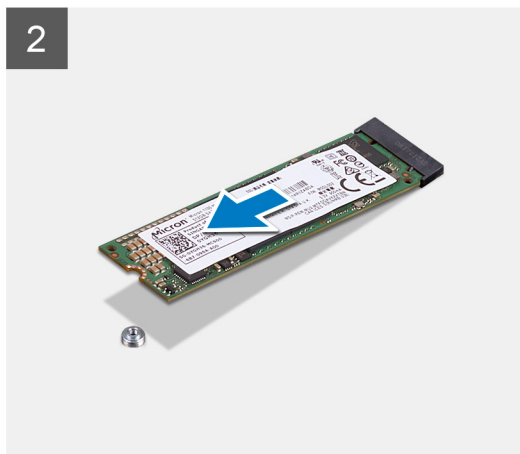
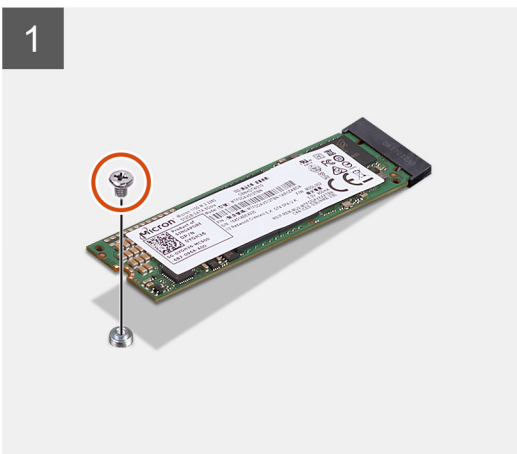



## Steps

1. Remove the screw (M2x3.5) that secures the solid-state drive to the system board.

 **NOTE:** The system has two solid-state drive slots.

2. Slide and lift the solid-state drive off the system board.

## Installing the M.2 2280 PCIe solid-state drive

### Prerequisites

If you are replacing a component, remove the existing component before performing the installation procedure.

### About this task

The following image indicates the location of the solid-state drive and provides a visual representation of the installation procedure.



**1x**  
M2x3.5

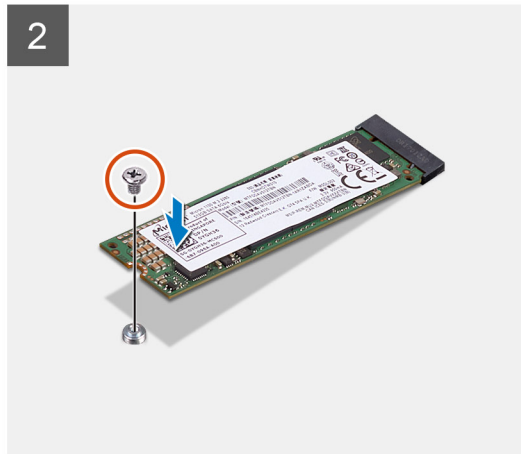
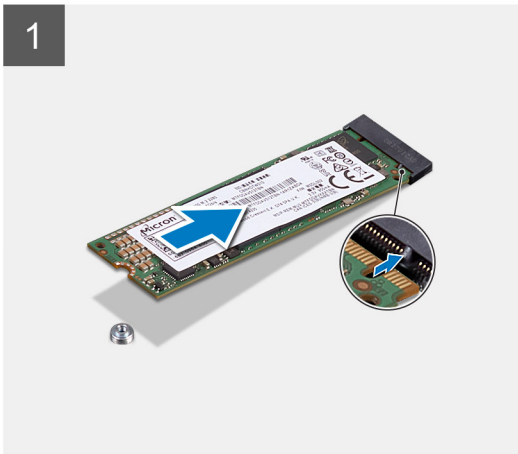
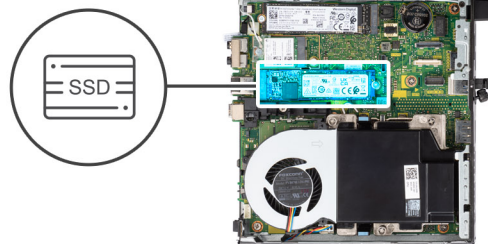





1x  
M2x3.5

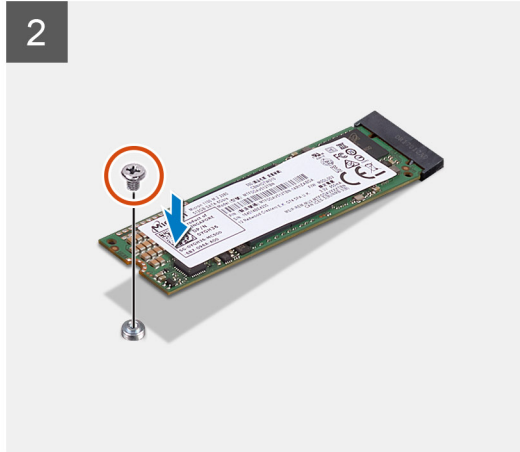
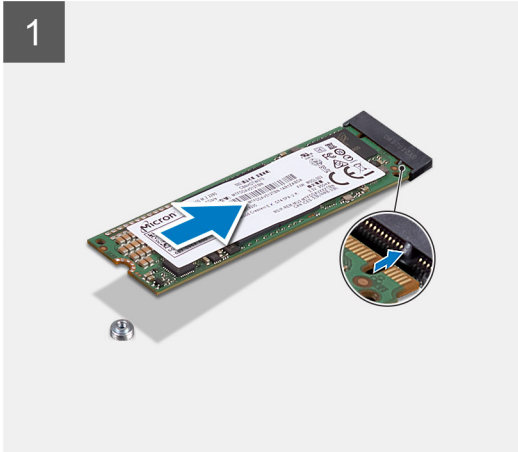
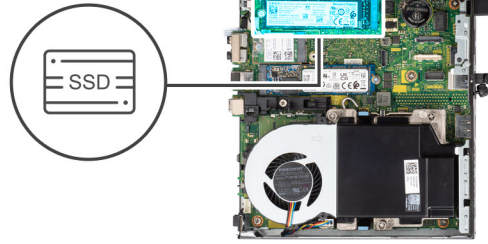

### Steps

1. Align the notch on the solid-state drive with the tab on the solid-state drive connector on the system board.
2. Insert the solid-state drive at a 45-degree angle into the solid-state drive connector.
3. Replace the screw (M2x3.5) that secures the M.2 2280 PCIe solid-state drive to the system board.

### Next steps

1. Install the [side cover](#).
2. Follow the procedure in [after working inside your computer](#).

## WLAN card

### Removing the WLAN card

#### Prerequisites

1. Follow the procedure in [before working inside your computer](#).
2. Remove the [side cover](#).

#### About this task

The following images indicate the location of the wireless card and provide a visual representation of the removal procedure.



1x  
M2x3.5

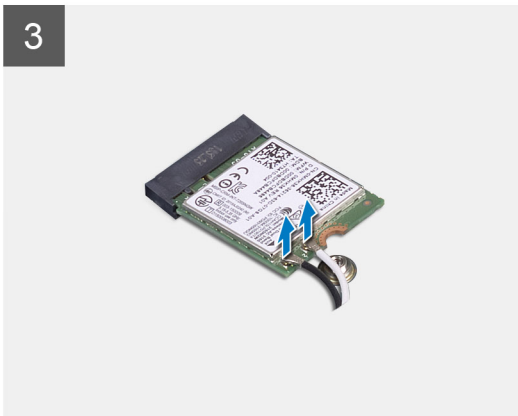

### Steps

1. Remove the (M2x3.5) screw that secures the WLAN card bracket to the system board.
2. Slide and lift the WLAN card bracket away from the WLAN card.
3. Disconnect the antenna cables from the WLAN card.
4. Slide and remove the WLAN card from the connector on the system board.

## Installing the WLAN card

### Prerequisites

If you are replacing a component, remove the existing component before performing the installation procedure.

### About this task

The following image indicates the location of the wireless card and provides a visual representation of the installation procedure.



1x  
M2x3.5

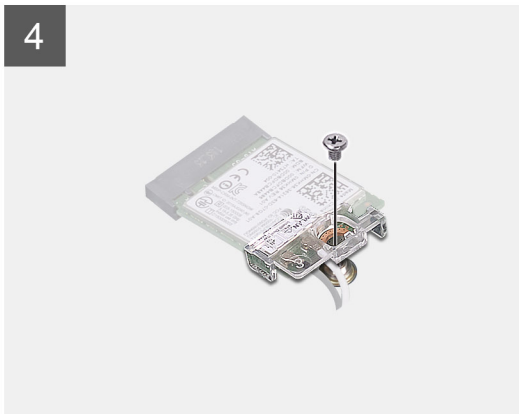
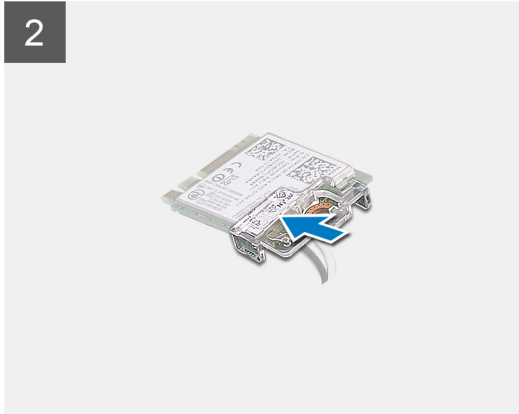
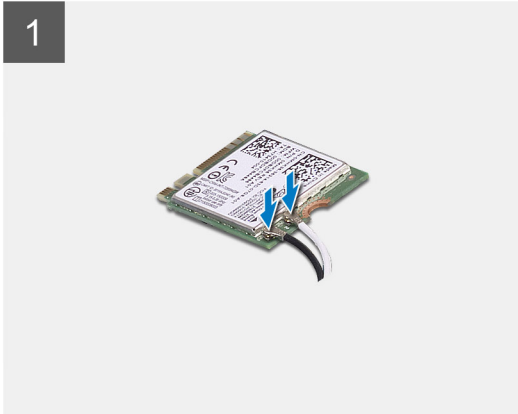
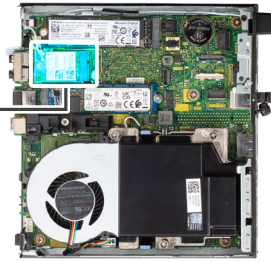

### Steps

1. Connect the antenna cables to the WLAN card.  
The following table provides the antenna-cable color scheme for the WLAN card of your computer.

**Table 2. Antenna-cable color scheme**

Connectors on the wireless card	Antenna-cable color
Main (white triangle)	White
Auxiliary (black triangle)	Black

2. Place the WLAN card bracket to secure the antenna cables.
3. Align the notch on the WLAN card with the tab on the WLAN card slot. Insert the WLAN card into the connector on the system board.
4. Replace the (M2x3.5) screw to secure the WLAN card bracket to the WLAN card.

### Next steps

1. Install the [side cover](#).
2. Follow the procedure in [after working inside your computer](#).

# Fan assembly

## Removing the fan assembly

### Prerequisites

**NOTE:** Based on the configuration ordered the images may slightly vary from the actual system. The images are still applicable to convey the service procedures accurately.

1. Follow the procedure in [before working inside your computer](#).
2. Remove the [side cover](#).
3. Remove the [speaker](#).

### About this task

The following images indicate the location of the fan assembly and provide a visual representation of the removal procedure.

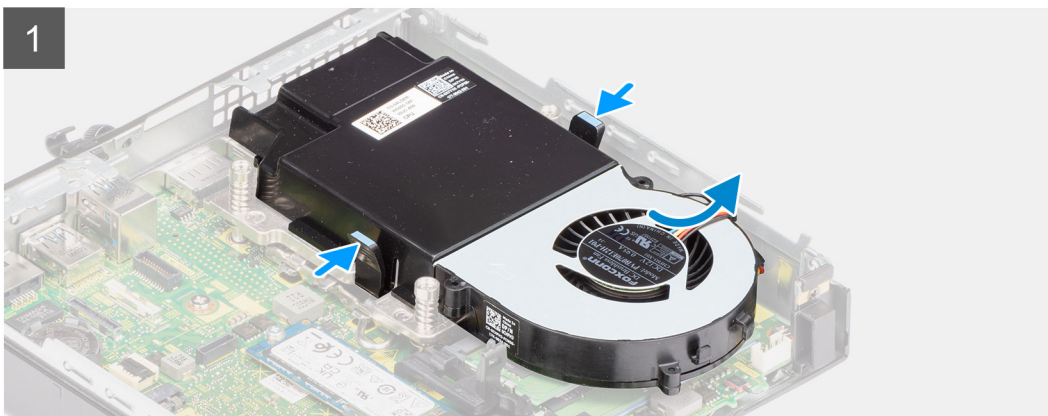
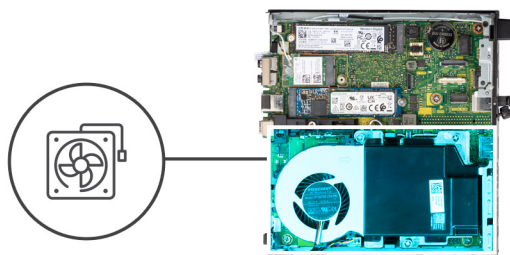

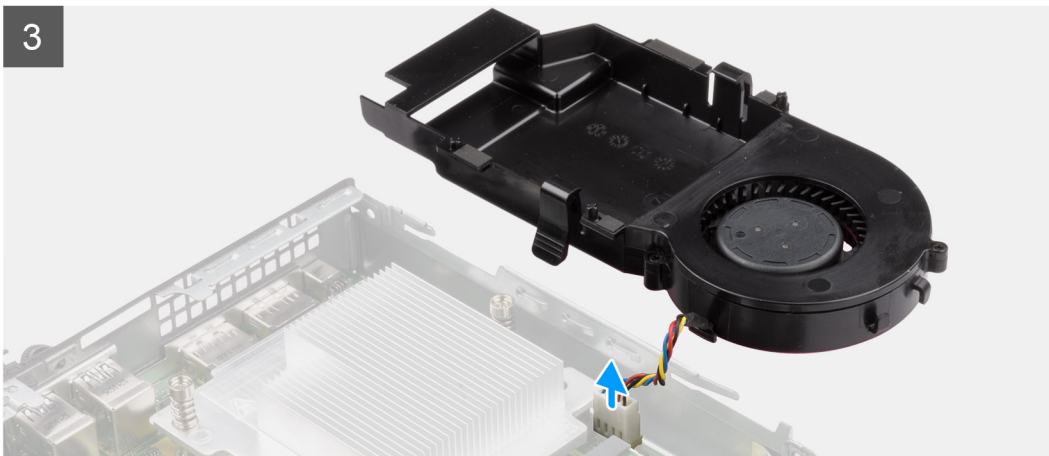

### Steps

1. Press the blue tabs on both sides of the fan, and slide to lift the fan to release it from the system.
2. Turn the fan assembly over.
3. Disconnect the fan cable from the connector on the system board. Lift the fan assembly out of the system.

## Installing the fan assembly

### Prerequisites

If you are replacing a component, remove the existing component before performing the installation procedure.

### About this task

The following images indicate the location of the fan assembly and provide a visual representation of the removal procedure.



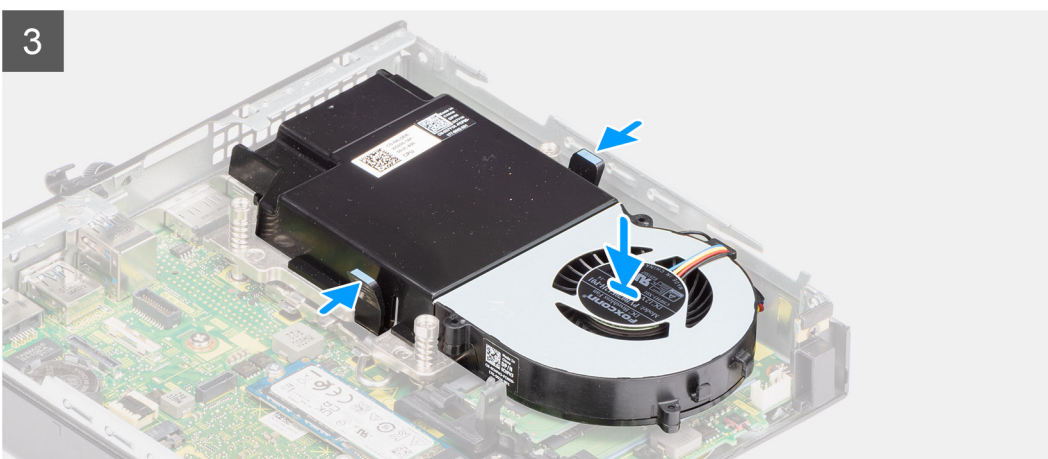
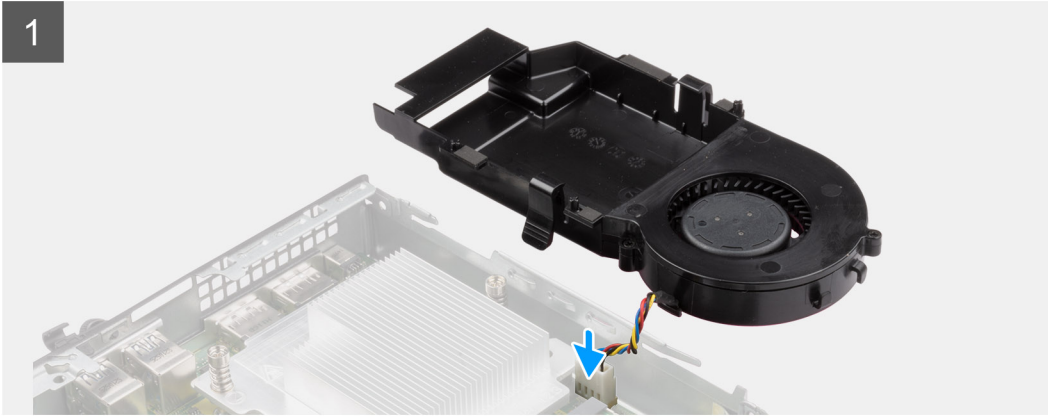
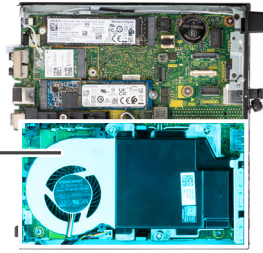

### Steps

1. Connect the fan cable to the connector on the system board.
2. Turn the fan assembly over.

3. Press the release tab on the fan assembly and place it on the system until it clicks into place.

### Next steps

1. Install the [speaker](#).
2. Install the [side cover](#).
3. Follow the procedure in [after working inside your computer](#).

## Heat sink

 **NOTE:** This section applies to 35 W and 65 W configuration systems.

## Removing the heat sink

### Prerequisites

1. Follow the procedure in [before working inside your computer](#).
2. Remove the [side cover](#).
3. Remove the [speaker](#).
4. Remove the [fan assembly](#).

### About this task

The following images indicate the location of the heat sink and provide a visual representation of the removal procedure.

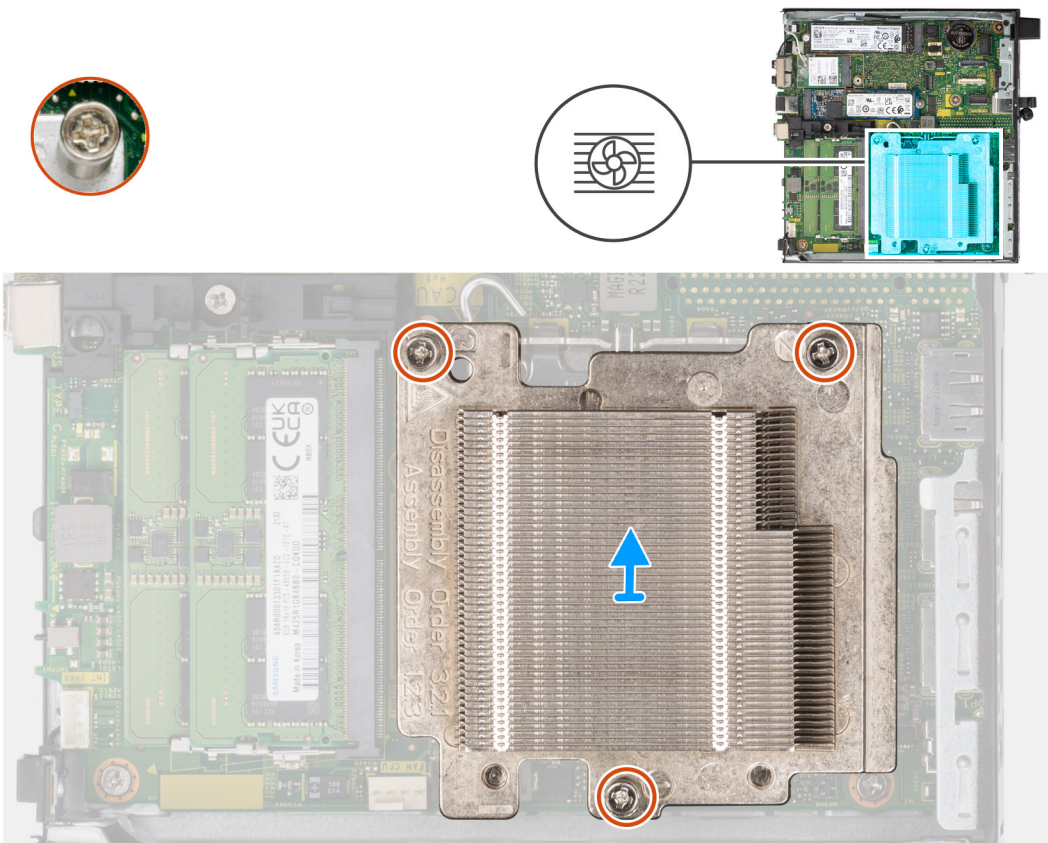

### Steps

1. Loosen the three captive screws that secure the heat sink to the system.

**NOTE:** Loosen the screw in the sequential order (1,2,3) as printed on the heat sink.

2. Lift the heat-sink away from the system board.

## Installing the heat sink

### Prerequisites

If you are replacing a component, remove the existing component before performing the installation procedure.

### About this task

The following image indicates the location of the heat sink and provides a visual representation of the installation procedure.



3x

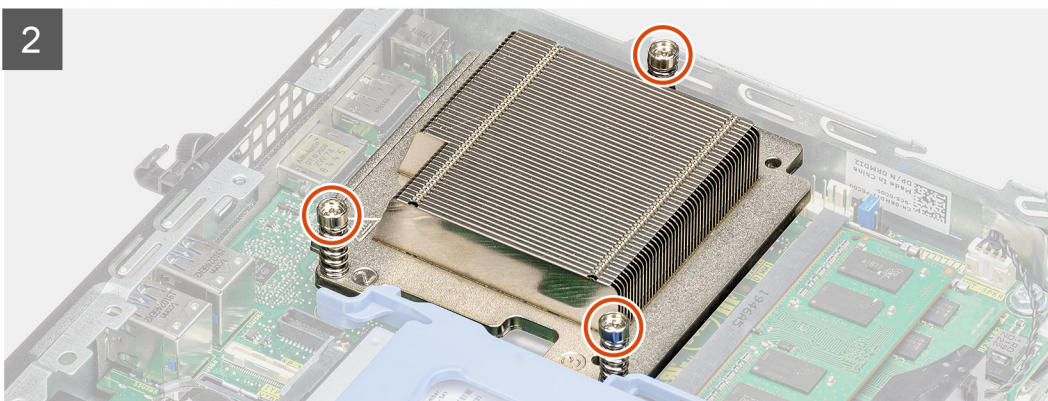
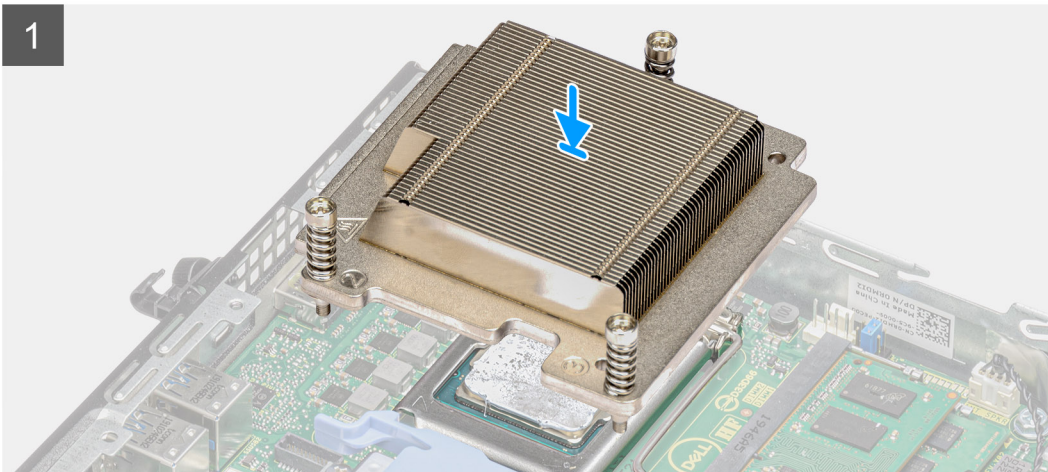
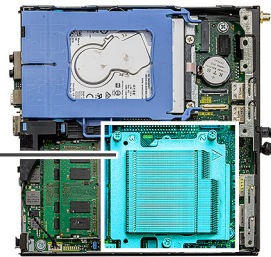

### Steps

1. Align the screws of the heat sink with the holders on the system board and place the heat sink on the processor.
2. Tighten the captive screws that secure the heat sink to the system board.

**NOTE:** Tighten the screws in a sequential order (1,2,3) as printed on the heat sink.



### Next steps

1. Install the [fan assembly](#).
2. Install the [speaker](#).
3. Install the [side cover](#).
4. Follow the procedure in [after working inside your computer](#).

## Coin-cell battery

### Removing the coin-cell battery

#### Prerequisites

1. Follow the procedure in [before working inside your computer](#).
2. Remove the [side cover](#).

**i** **NOTE:** Removing the coin-cell battery resets the BIOS setup program settings to default. It is recommended that you note the BIOS setup program settings before removing the coin-cell battery.

#### About this task

The following images indicate the location of the coin-cell battery and provide a visual representation of the removal procedure.

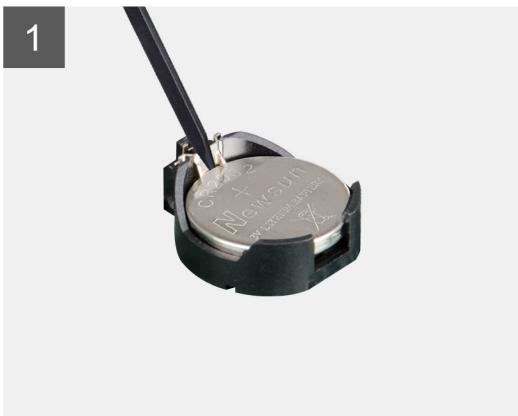
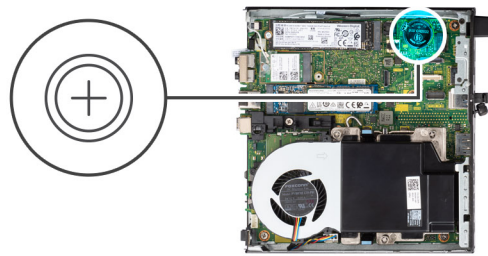

#### Steps

1. Using a plastic scribe, gently pry the coin-cell battery out of the battery socket on the system board.
2. Remove the coin-cell battery out of the system.

### Installing the coin-cell battery

#### Prerequisites

If you are replacing a component, remove the existing component before performing the installation procedure.

### About this task

The following image indicates the location of the coin-cell battery and provides a visual representation of the installation procedure.

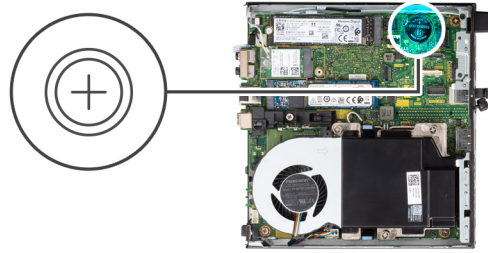

### Steps

1. Insert the coin cell battery with the "+" sign facing up and slide it under the securing tabs at the positive side of the connector.
2. Press the battery into the connector until it locks into place.

### Next steps

1. Install the [side cover](#).
2. Follow the procedure in [after working inside your computer](#).

## Memory modules

### Removing the memory modules

#### Prerequisites

1. Follow the procedure in [before working inside your computer](#).
2. Remove the [side cover](#).
3. Remove the [speaker](#).
4. Remove the [fan assembly](#).

### About this task

The following images indicate the location of the memory modules and provide a visual representation of the removal procedure.

**CAUTION:** To prevent damage to the memory module, hold the memory module by the edges. Do not touch the components on the memory module.

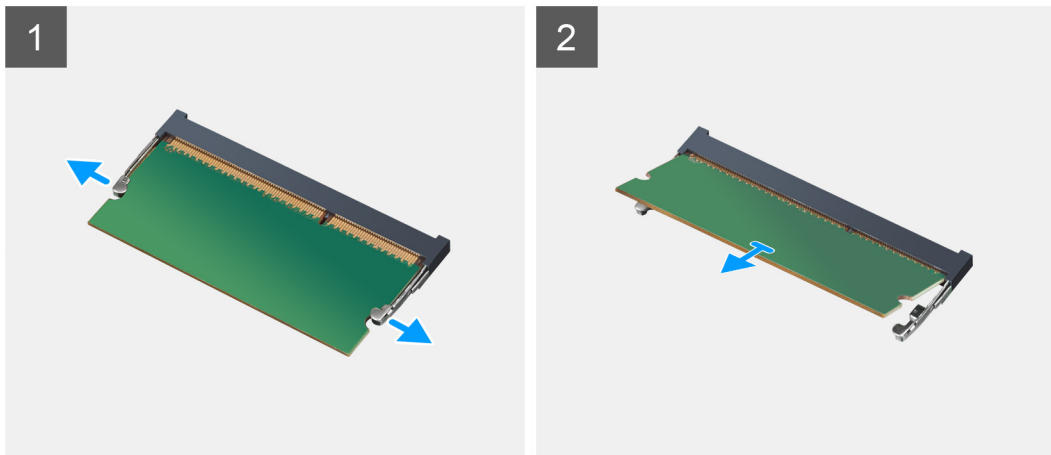
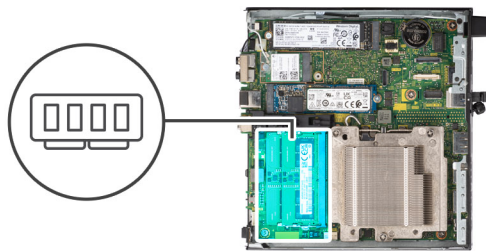

### Steps

1. Pull the securing clips from the memory module until the memory module pops up.
2. Slide and remove the memory module from the memory-module slot.

**CAUTION:** To prevent damage to the memory module, hold the memory module by the edges. Do not touch the components on the memory module.

**NOTE:** Repeat step 1 to step 2 to remove any other memory modules installed in your computer.

**NOTE:** Note the slot and the orientation of the memory module in order to replace it in the correct slot.

## Installing the memory modules

### Prerequisites

If you are replacing a component, remove the existing component before performing the installation procedure.

### About this task

The following image(s) indicate the location of the memory modules and provide a visual representation of the installation procedure.

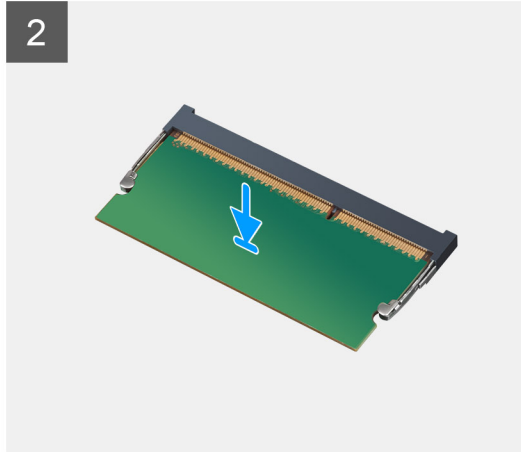
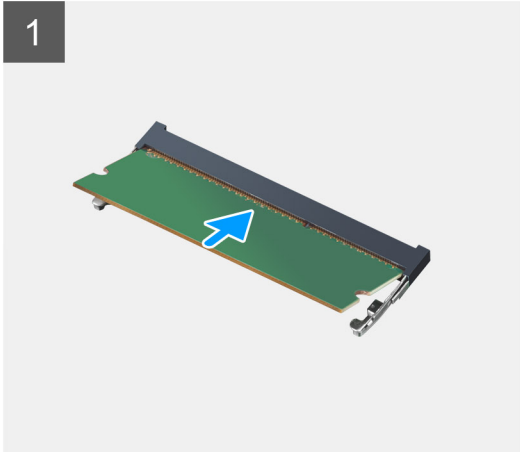
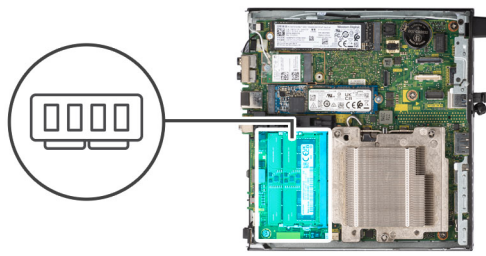

### Steps

1. **NOTE:** The thermal pad is applicable only for computers with 32 GB x 2 configuration, install the thermal pad before installing the 32 GB x 2 memory module.

Verify if the SODIMM thermal pad is bent or out of shape. If yes, then press the thermal pad to secure it properly to the system board.

OptiPlex 7000 Micro has SODIMM thermal pad 100% attached on system board. SODIMM thermal pad is not reusable. There is no residual upon removal of the SODIMM thermal pad from the system board.

1. **NOTE:** The thermal pad can create the push up force, when assembling the SODIMM module have to be pressed down and latched.

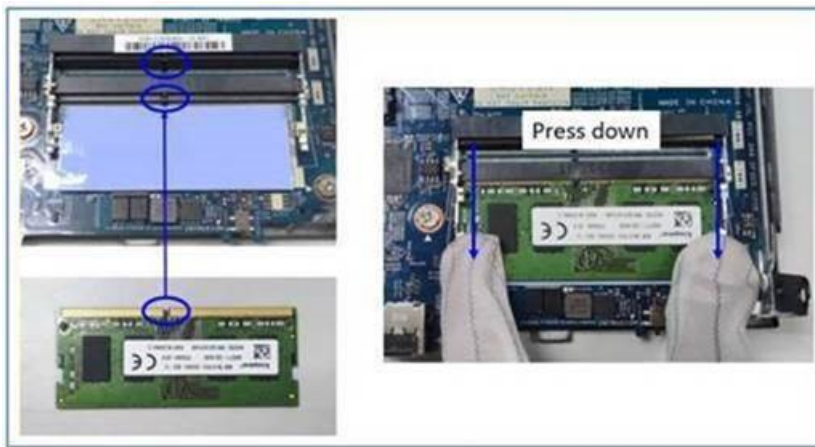

2. Partially remove the anti-adhesive paper from the SODIMM thermal pad.
  1. **NOTE:** Do not touch the adhesive surface of the SODIMM thermal pad.
3. Using a scraper, press the SODIMM thermal pad from left to right edge on the memory module slot.
  1. **NOTE:** Refer the thermal pad area in the image as reference for assembly positioning.

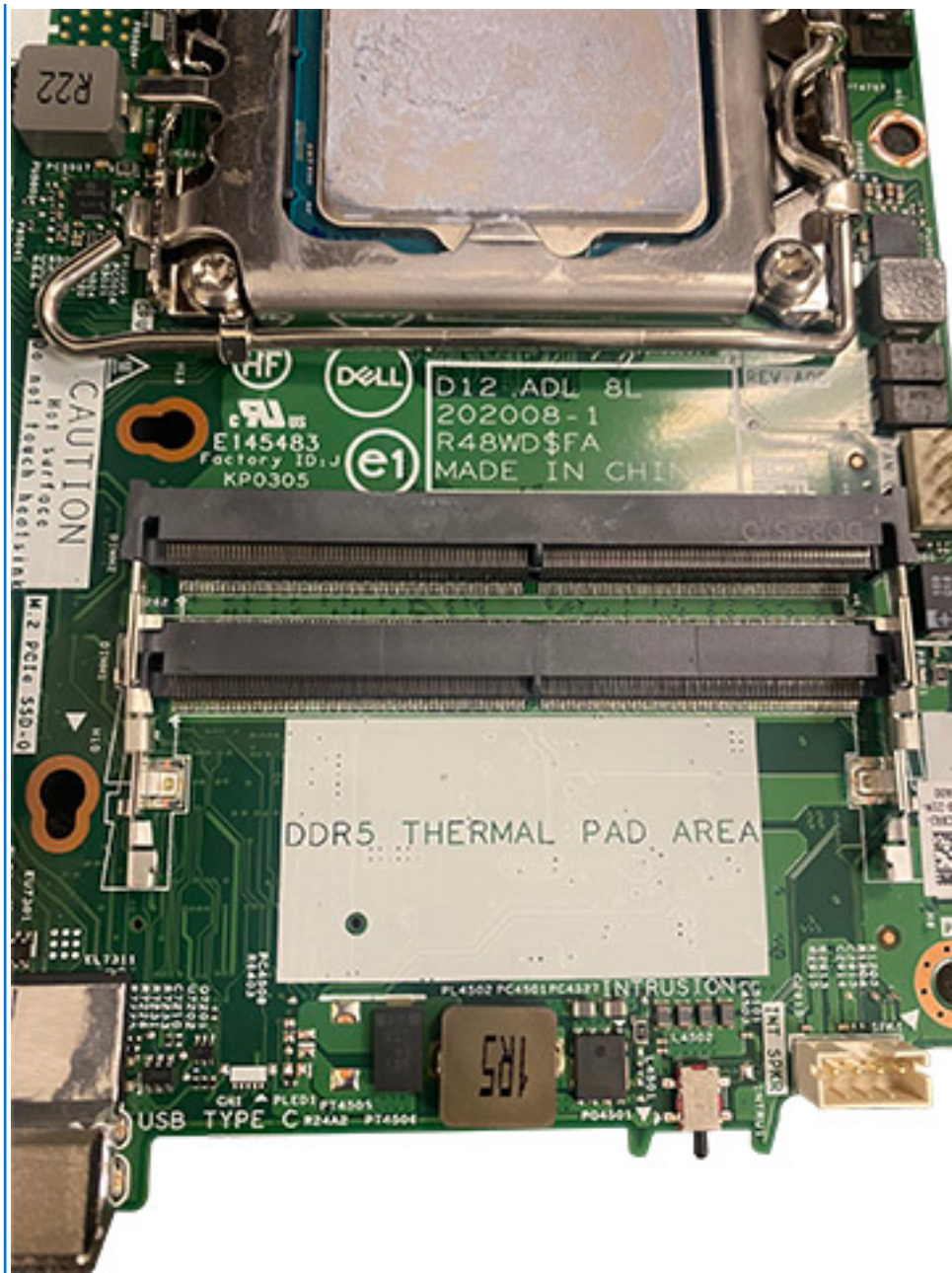

**NOTE:** Ensure that the SODIMM thermal pad is attached properly and the thermal pad is not bent or out of shape.

4. Push and remove the adhesive layer on the SODIMM thermal pad.





**NOTE:** Check if there is any SODIMM pad residual on the thermal pad and clean the residual up.

5. Align the notch on the memory module with the tab on the memory-module slot.
6. Insert the memory module into the memory-module slot.
7. Press down on the memory module until the memory module snaps into position and the securing clip locks in place.

**CAUTION:** To prevent damage to the memory module, hold the memory module by the edges. Do not touch the components on the memory module.

- NOTE:** The securing clips return to the locked position. If you do not hear the click, remove the memory module and reinstall it.
- NOTE:** If the memory module is difficult to remove, gently ease the memory module back and forth to remove it from the slot.
- NOTE:** Repeat step 5 to 7 when installing more than one memory module in your computer.

### Next steps

1. Install the [fan assembly](#).
2. Install the [speaker](#).
3. Install the [side cover](#).
4. Follow the procedure in [after working inside your computer](#).

## Optional I/O modules (Type C/HDMI/VGA/DP/Serial)

### Removing optional I/O modules (Type C/HDMI/VGA/DP/Serial)

#### Prerequisites

1. Follow the procedure in [before working inside your computer](#).
2. Remove the [side cover](#).

#### About this task

The following images indicate the location of the optional I/O modules and provide a visual representation of the removal procedure.

 **NOTE:** This is an example of the procedure and removal steps are applicable for optional I/O modules (Type C/HDMI/VGA/DP/Serial).



**2x**  
M2x3

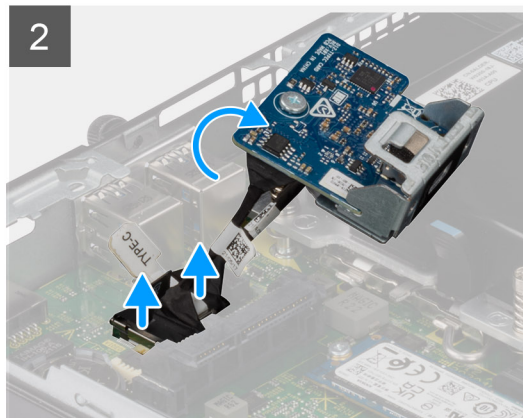
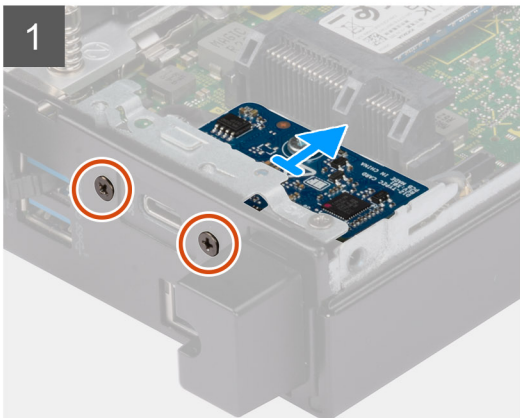



2x  
M2x3

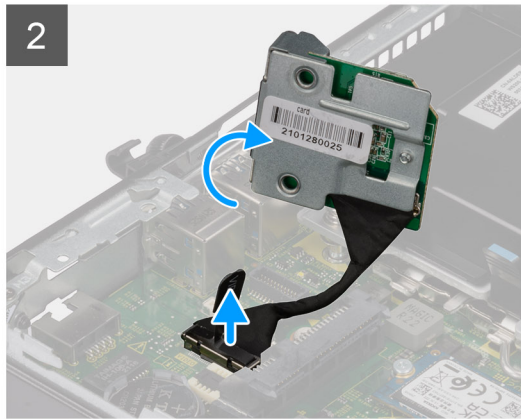
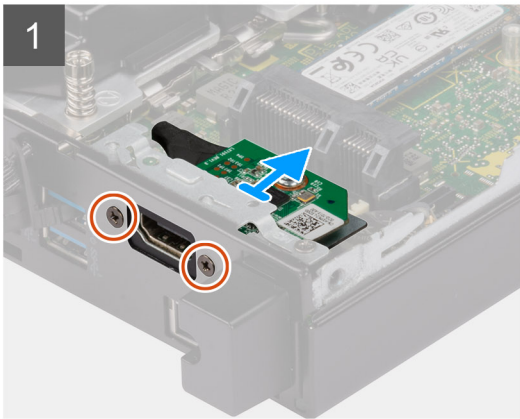

2x  
M2x5

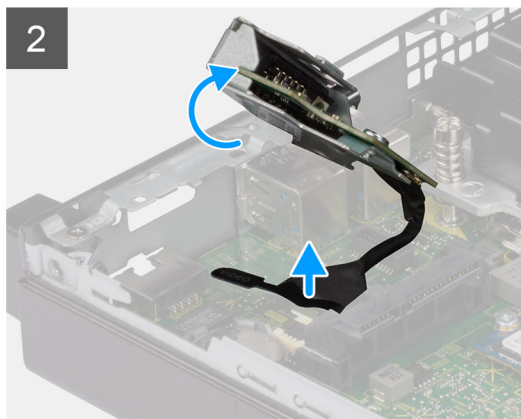
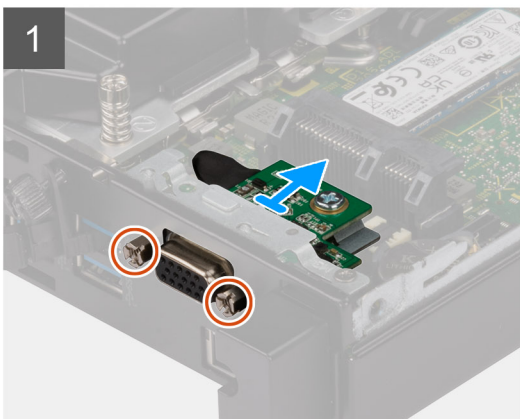

### Steps

1. Remove the two (M3x3) screws that secure the optional I/O modules or two (M2x5) cross type screws that secure the serial module to the computer chassis.
2. Disconnect the I/O-module cable from the connector on the system board.
3. Remove the I/O module from the computer.

## Installing optional I/O modules (Type C/HDMI/VGA/DP/Serial)

### Prerequisites

If you are replacing a component, remove the existing component before performing the installation procedure.



**About this task**

The following images indicate the location of the system board and provide a visual representation of the installation procedure.

**i** **NOTE:** This is an example of the procedure and installation steps are applicable for optional I/O modules (Type C/HDMI/VGA/DP/Serial).



**2x**  
M3x3

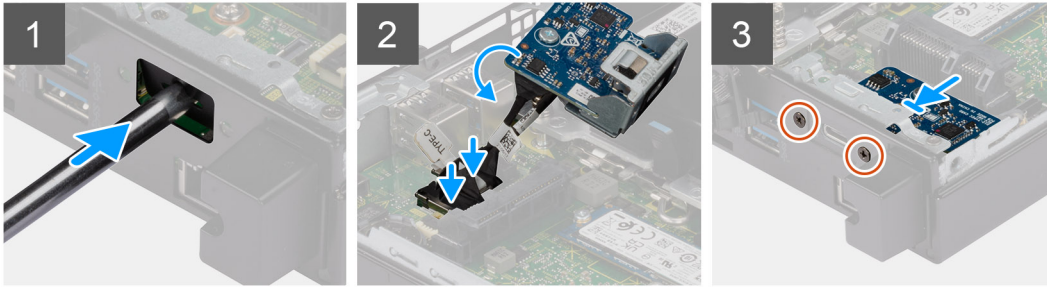

**2x**  
M2x3

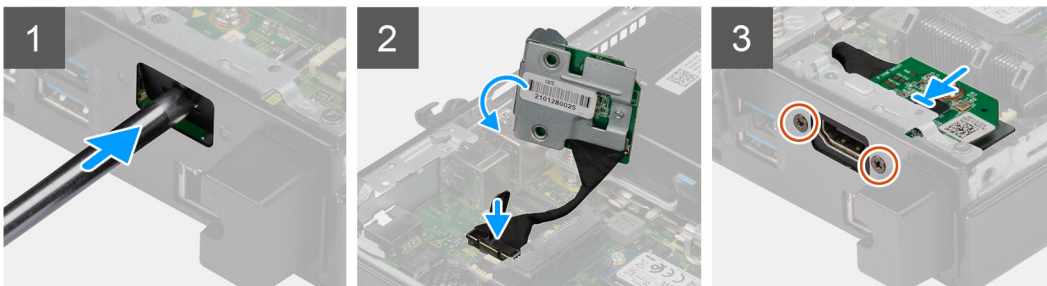



2x  
M2x5

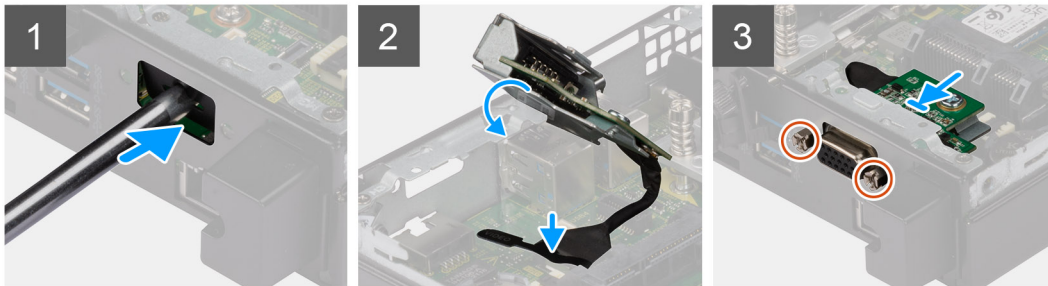

### Steps

1. To remove the dummy metal bracket, insert a flat-head screwdriver in the hole of the bracket. Push the bracket to release the bracket, and then lift the bracket out from the system.  
**i** **NOTE:** This step applies if you are upgrading the system with no expansion port.
2. Insert the optional I/O module into its slot from the inside of your computer.
3. Connect the I/O cable to the connector on the system board.
4. Replace the two (M3x3) screws that secure the optional I/O modules or two (M2x5) cross type screws that secure the serial module to the computer chassis.

### Next steps

1. Install the [side cover](#).
2. Follow the procedure in [after working inside your computer](#).

## Speaker

### Removing the speaker

#### Prerequisites

1. Follow the procedure in [before working inside your computer](#).
2. Remove the [side cover](#).

#### About this task

The following images indicate the location of the speaker and provide a visual representation of the removal procedure.

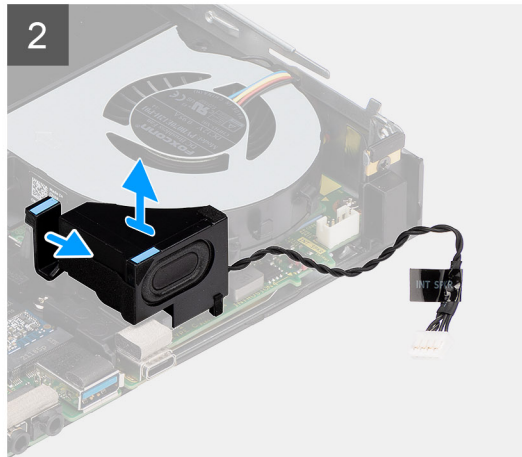
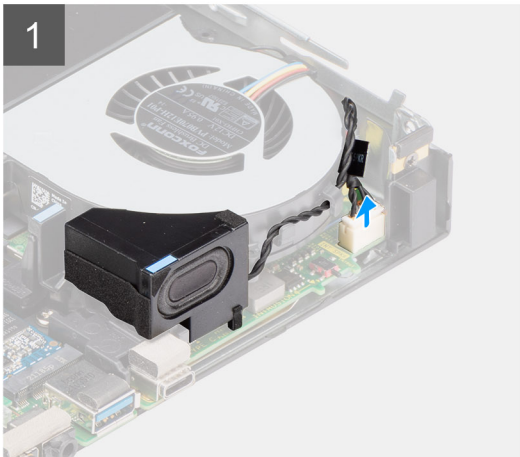
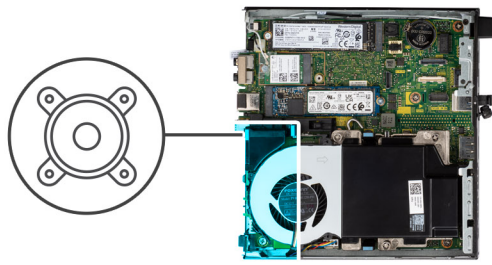

### Steps

1. Disconnect the speaker cable from the system board.
2. Unroute the speaker cable from the routing guides on the fan assembly.
3. Press the release tab and lift the speaker along with the cable from the system board.

## Installing the speaker

### Prerequisites

If you are replacing a component, remove the existing component before performing the installation procedure.

### About this task

The following image indicates the location of the speaker and provides a visual representation of the installation procedure.

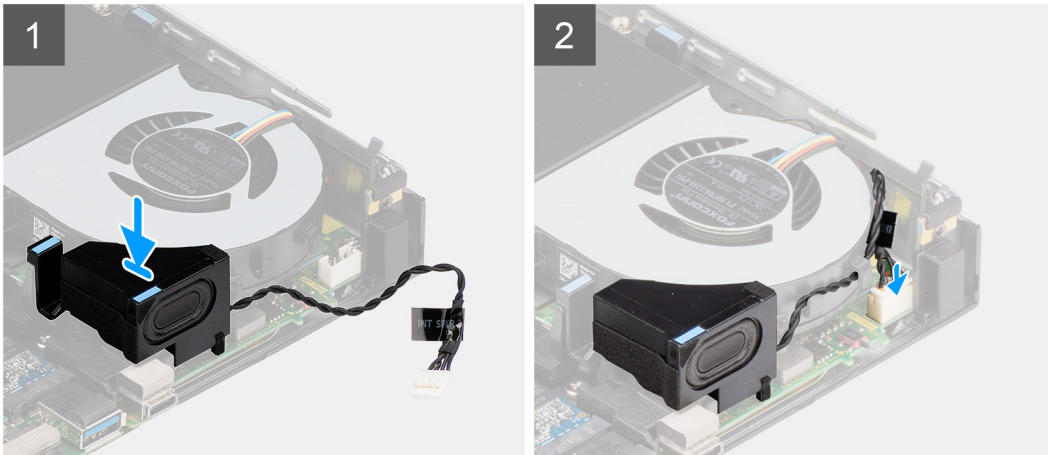
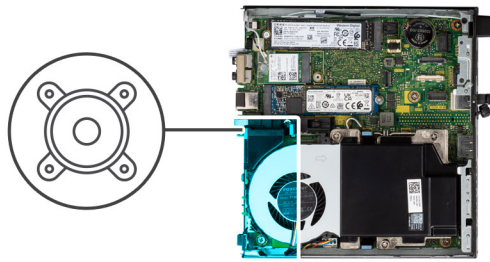

### Steps

1. Align and insert the speaker into the slot and press it until the release tab clicks.
2. Route the speaker cable in the routing guides on the fan assembly.
3. Connect the speaker cable to the system board.

### Next steps

1. Install the [side cover](#).
2. Follow the procedure in [after working inside your computer](#).

## Processor

### Removing the processor

#### Prerequisites

1. Follow the procedure in [before working inside your computer](#).
2. Remove the [side cover](#).
3. Remove the [speaker](#).
4. Remove the [fan assembly](#).
5. Remove the [heat sink](#).

#### About this task

The following images indicate the location of the processor and provide a visual representation of the removal procedure.

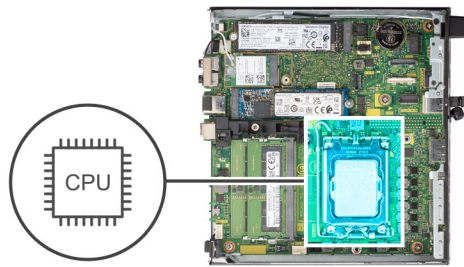

### Steps

1. Press down and push the release lever away from the processor to release it from the securing tab.
2. Lift the lever upward to lift the processor cover.

**CAUTION:** When removing the processor, do not touch any of the pins inside the socket or allow any objects to fall on the pins in the socket.

3. Gently lift the processor from the processor socket.

## Installing the processor

### Prerequisites

If you are replacing a component, remove the existing component before performing the installation procedure.

### About this task

The following image indicates the location of the processor and provides a visual representation of the installation procedure.

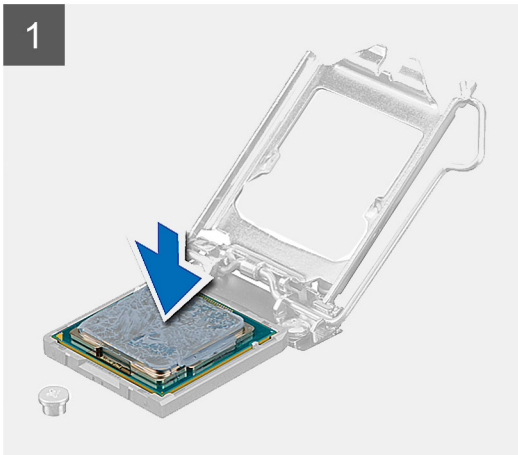
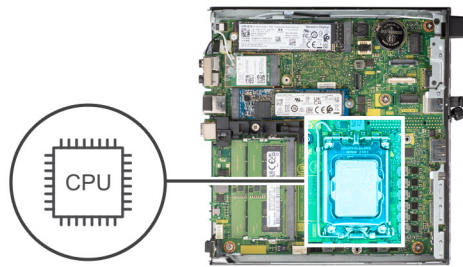

### Steps

1. Align the pin-1 corner of the processor with the pin 1 corner of the processor socket, and then place the processor in the processor socket.  
**i** **NOTE:** The pin-1 corner of the processor has a triangle that aligns with the triangle on the pin-1 corner on the processor socket. When the processor is properly seated, all four corners are aligned at the same height. If one or more corners of the processor are higher than the others, the processor is not seated properly.
2. When the processor is fully seated in the socket, close the processor cover.
3. Press down and push the release lever under the securing tab to lock it.

### Next steps

1. Install the [heat sink](#).
2. Install the [fan assembly](#).
3. Install the [speaker](#).
4. Install the [side cover](#).
5. Follow the procedure in [after working inside your computer](#).



# Internal Antenna

## Removing internal antenna (Location 1)

### Prerequisites

1. Follow the procedure in [before working inside your computer](#).
2. Remove the [side cover](#).
3. Remove the [WLAN card](#).

### About this task

The following images indicate the location of an internal antenna and provide a visual representation of the removal procedure.



1x  
M3x3

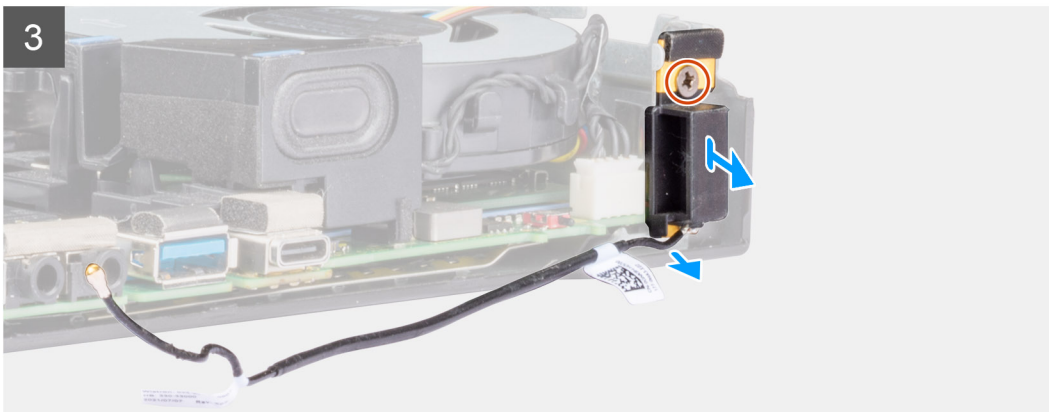
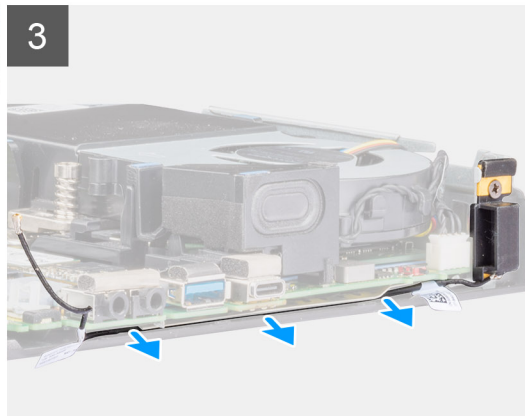
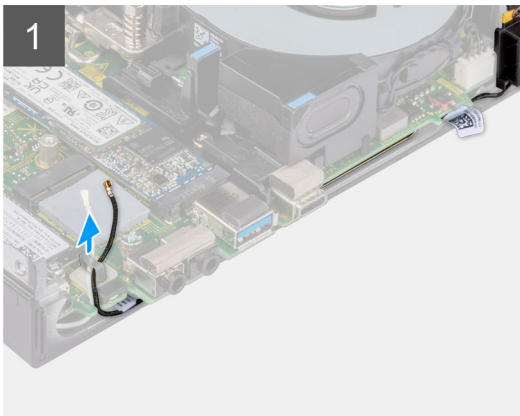
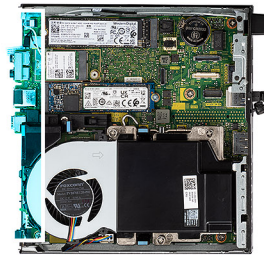

### Steps

1. Unroute the black antenna-cable from the routing guides under the EMI shielding.
2. Remove the screw (M3x3MM) that secures the internal antenna assembly to the chassis.
3. Lift the internal antenna assembly away from the chassis.

# Installing internal antenna (Location 1)

## Prerequisites

If you are replacing a component, remove the existing component before performing the installation procedure.

## About this task

The following images indicate the location of an internal antenna and provide a visual representation of the removal procedure.



1x  
M3x3

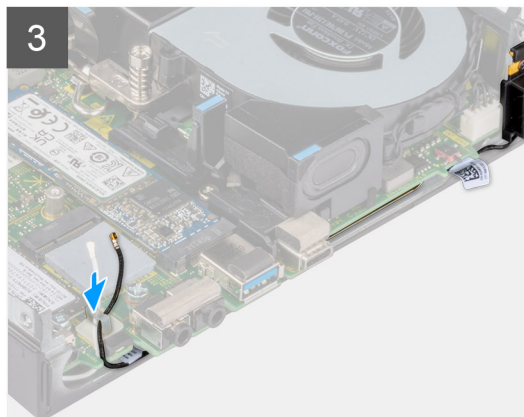
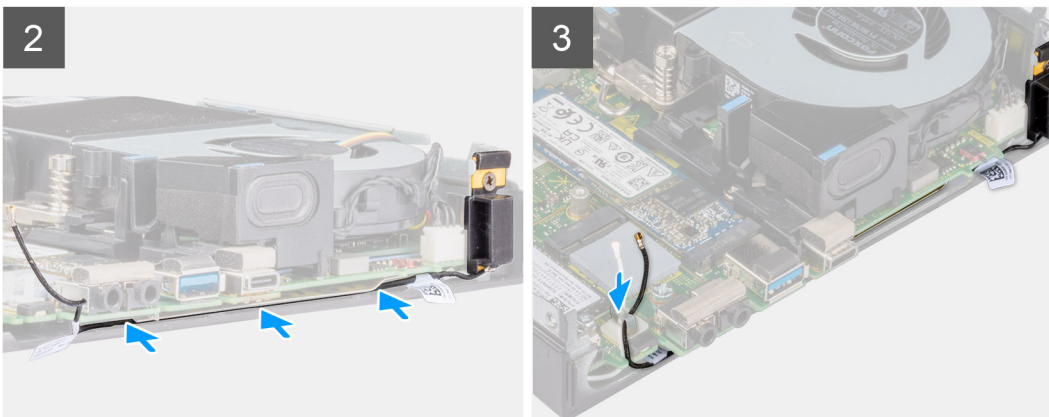
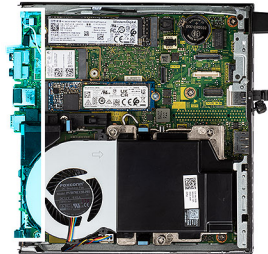

## Steps

1. Remove the adhesive tape from the internal antenna assembly.
2. Remove the adhesive tape from the chassis.
3. Align the internal antenna assembly to the chassis.
4. Replace the screw (M3x3MM) that secures the internal antenna assembly to the chassis.
5. Route the antenna-cable (black) under the EMI shielding with a tool.

## Next steps

1. Install the [WLAN card](#).
2. Install the [side cover](#).

3. Follow the procedure in [after working inside your computer](#).

## Removing internal antenna (Location 3)

### Prerequisites

1. Follow the procedure in [before working inside your computer](#).
2. Remove the [side cover](#).
3. Remove the [WLAN card](#).

### About this task

The following images indicate the location of an internal antenna and provide a visual representation of the removal procedure.



1x



1x  
M3x3

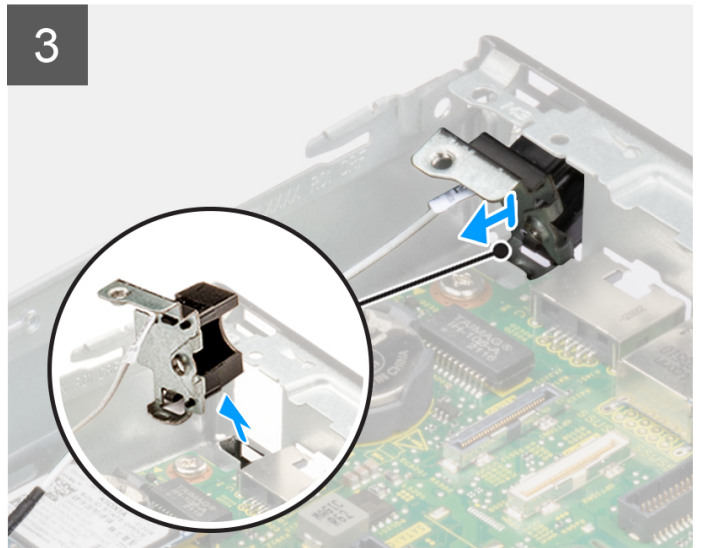
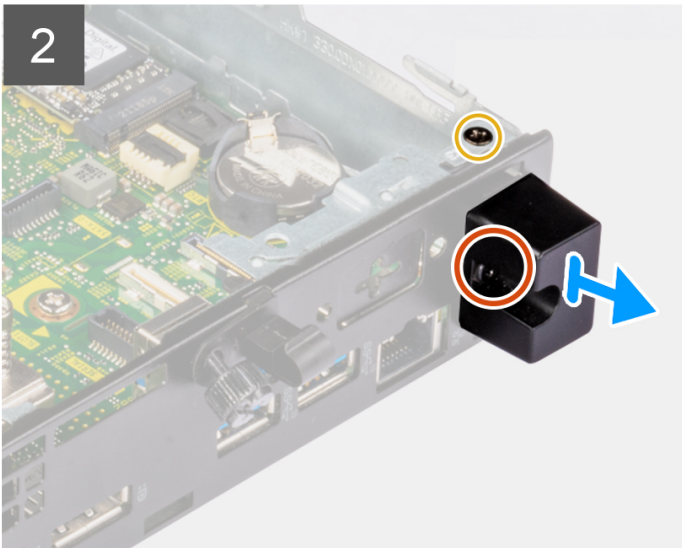
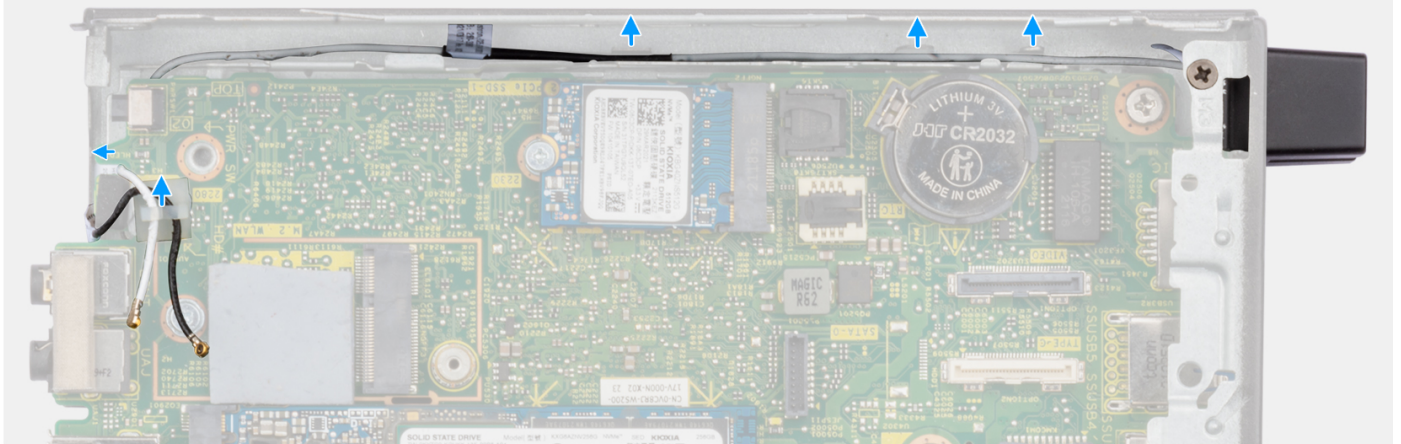
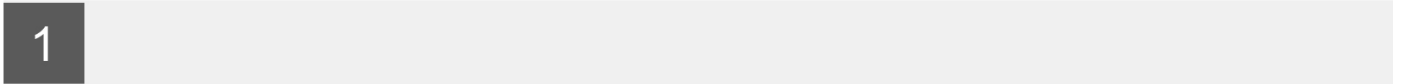
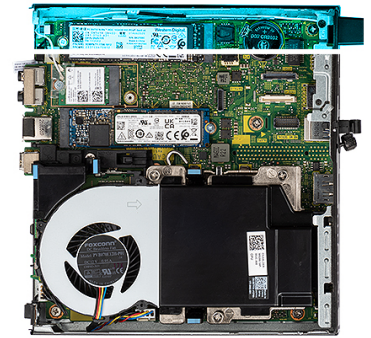

### Steps

1. Remove the screw (M3x3MM) that secures the internal antenna assembly to the chassis.
2. Remove the captive screw that secures the internal antenna cover to the chassis and lift it away.
3. Push the internal antenna assembly inside from the opening on the back view and lift it away from the chassis.



# Installing internal antenna (Location 3)

## Prerequisites

If you are replacing a component, remove the existing component before performing the installation procedure.

## About this task

The following images indicate the location of an internal antenna and provide a visual representation of the removal procedure.



1x



1x  
M3x3

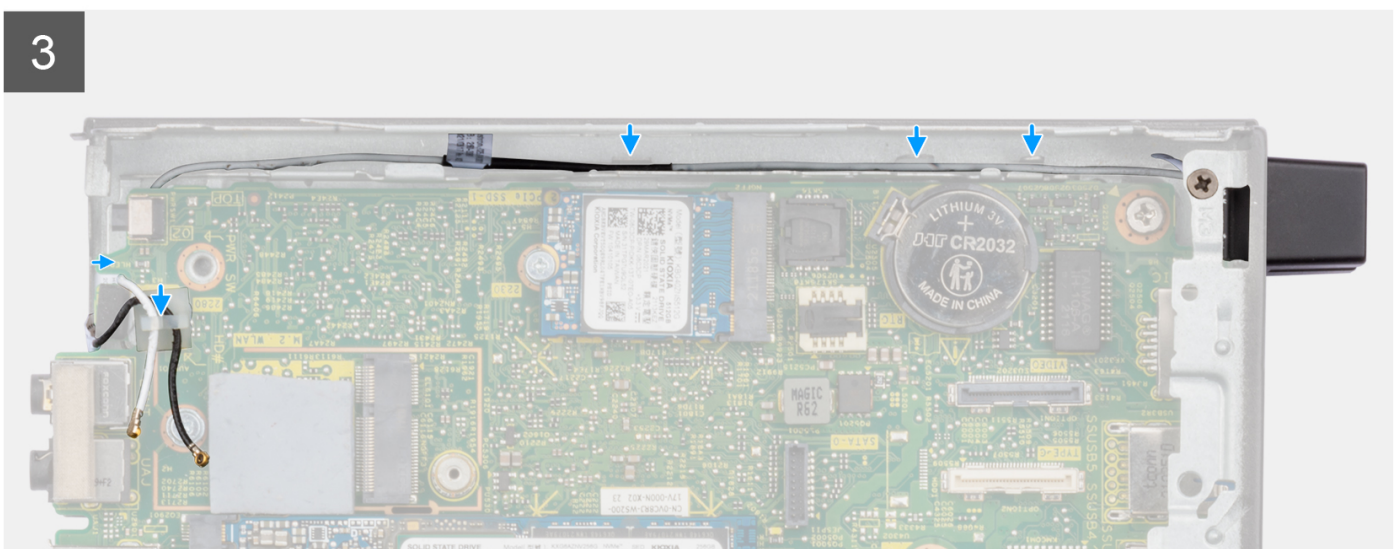
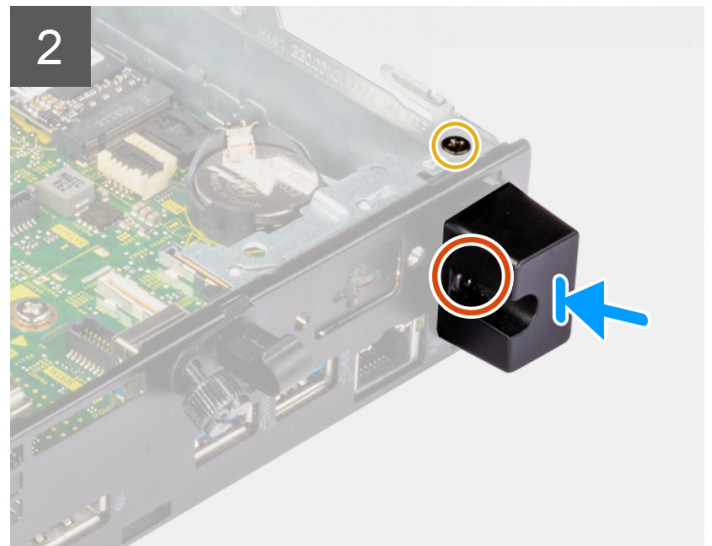
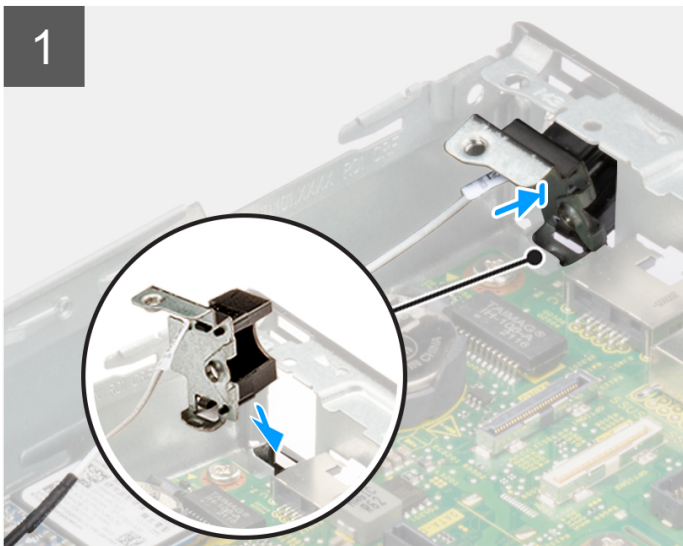
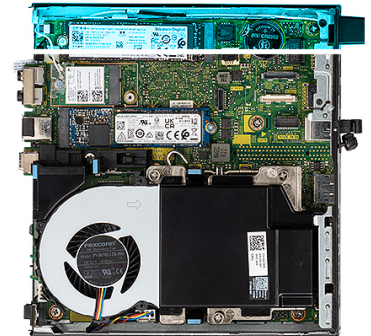

### Steps

1. Remove the fillers on the side cover.
2. Tilt the internal antenna assembly. Align and place the antenna bracket on the system board.
3. Insert the internal antenna assembly in the back view opening.
4. Align the screw hole on the internal antenna assembly with the screw hole on the back view.
5. Replace the captive screw that secures the internal antenna assembly to the chassis.
6. Replace the screw (M3x3MM) that secures the internal antenna cover to the chassis.
7. Route the antenna-cable (white) through the routing guides on the chassis.

### Next steps

1. Install the [WLAN card](#).
2. Install the [side cover](#).
3. Follow the procedure in [after working inside your computer](#).

## Removing SMA antenna (Location 3)

### Prerequisites

1. Follow the procedure in [before working inside your computer](#).
2. Remove the [side cover](#).
3. Remove the [WLAN card](#).

### About this task

The following images indicate the location of an internal antenna and provide a visual representation of the removal procedure.





1x  
M3x3

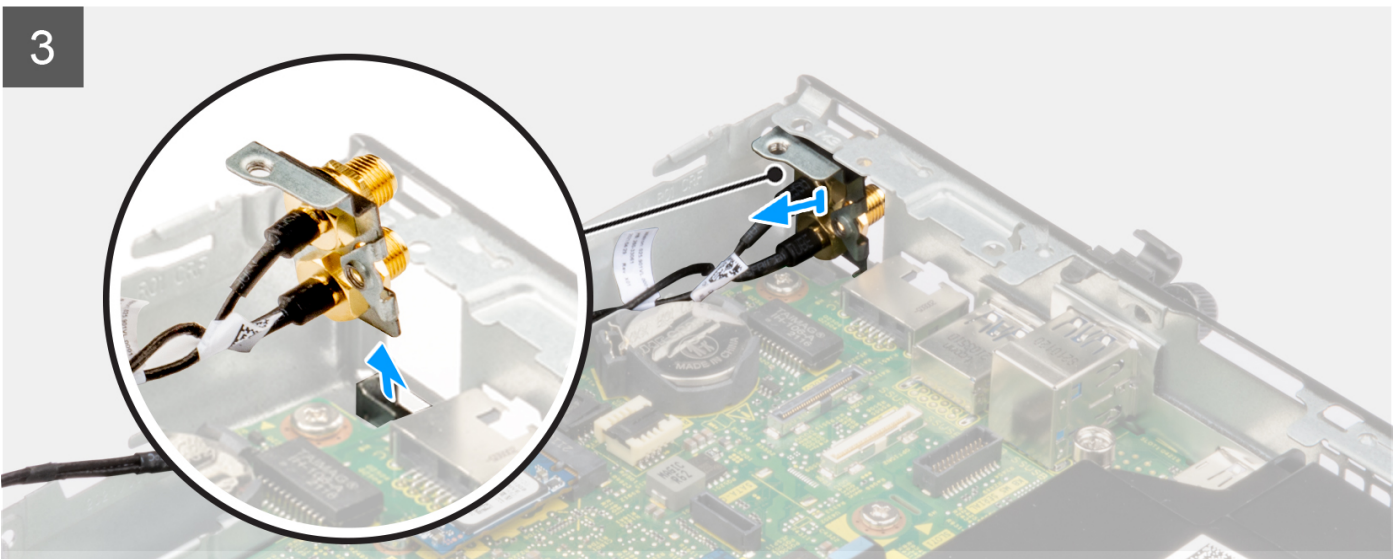
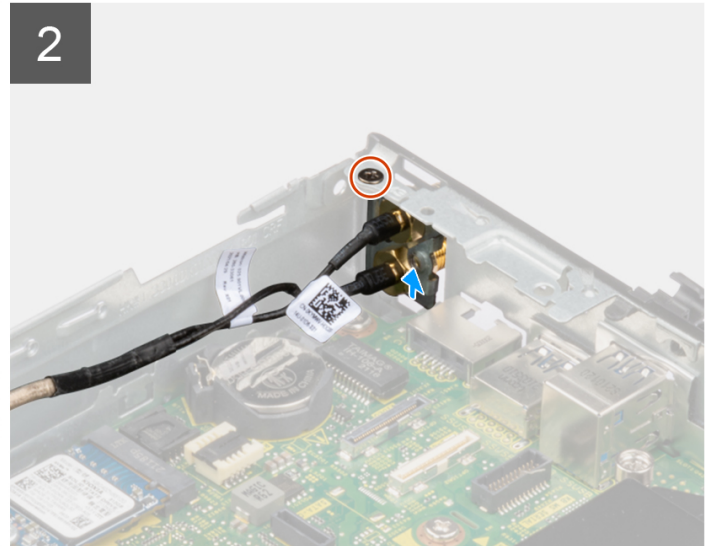
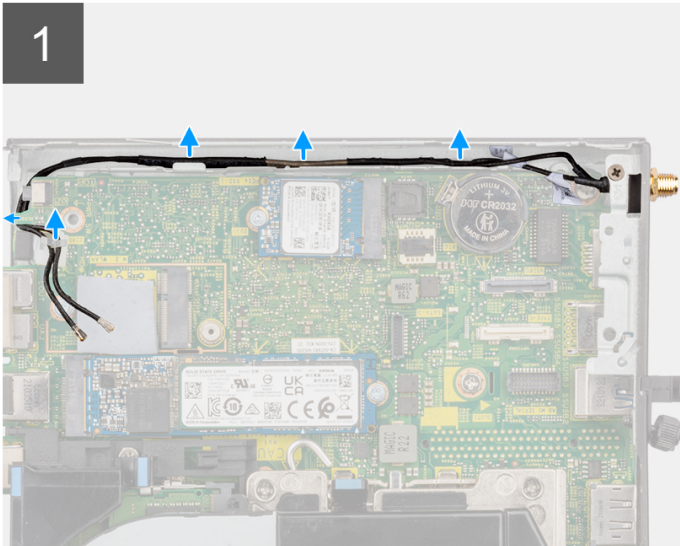
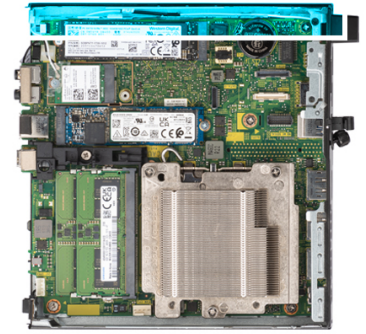

### Steps

1. Remove the screw (M3x3MM) that secures the internal antenna assembly to the chassis.
2. Push the SMA antenna assembly inside from the opening on the back view and lift it away from the chassis.

## Installing SMA antenna (Location 3)

### Prerequisites

If you are replacing a component, remove the existing component before performing the installation procedure.

### About this task

The following images indicate the location of SMA antenna and provide a visual representation of the removal procedure.



1x  
M3x3

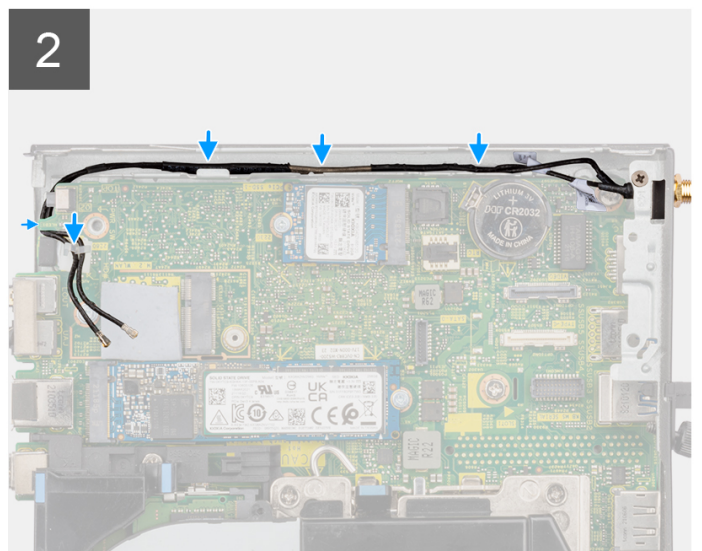
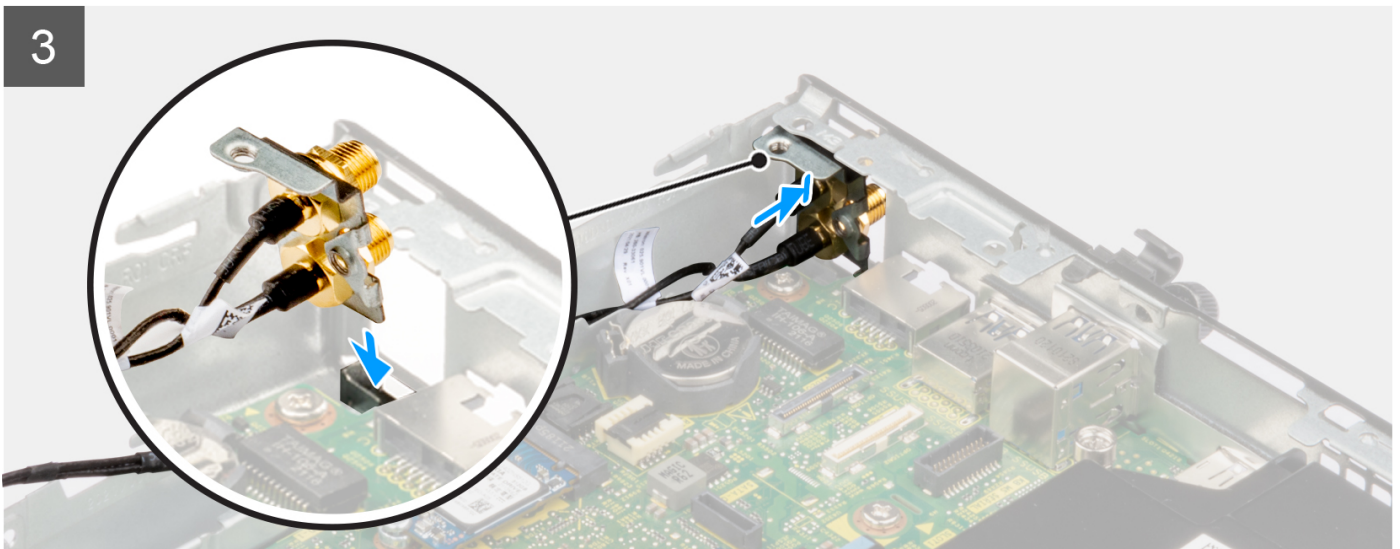
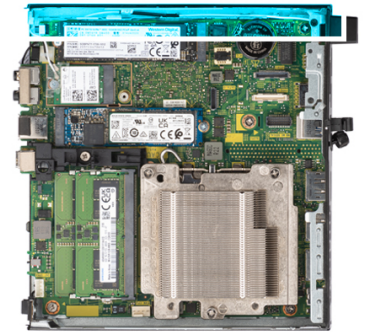

### Steps

1. Remove the fillers on the side cover.
2. Tilt the SMA antenna assembly. Align and place the antenna bracket on the system board.
3. Insert the SMA antenna assembly in the back view opening.
4. Align the screw hole on the SMA antenna assembly with the screw hole on the back view.
5. Replace the screw (M3x3MM) that secures the SMA antenna assembly to the chassis.
6. Route the antenna-cables through the routing guides on the chassis.

### Next steps

1. Install the [WLAN card](#).
2. Install the [side cover](#).
3. Follow the procedure in [after working inside your computer](#).

## System board

### Removing the system board

#### Prerequisites

1. Follow the procedure in [before working inside your computer](#).
2. Remove the [side cover](#).
3. Remove the [solid-state drive](#).
4. Remove the [WLAN card](#).
5. Remove the [fan assembly](#).
6. Remove the [heat sink](#).
7. Remove the [memory module](#).
8. Remove the [speaker](#).
9. Remove the [processor](#).

#### About this task

The following images indicate the location of the system board and provide a visual representation of the removal procedure.

#### 65 W system board

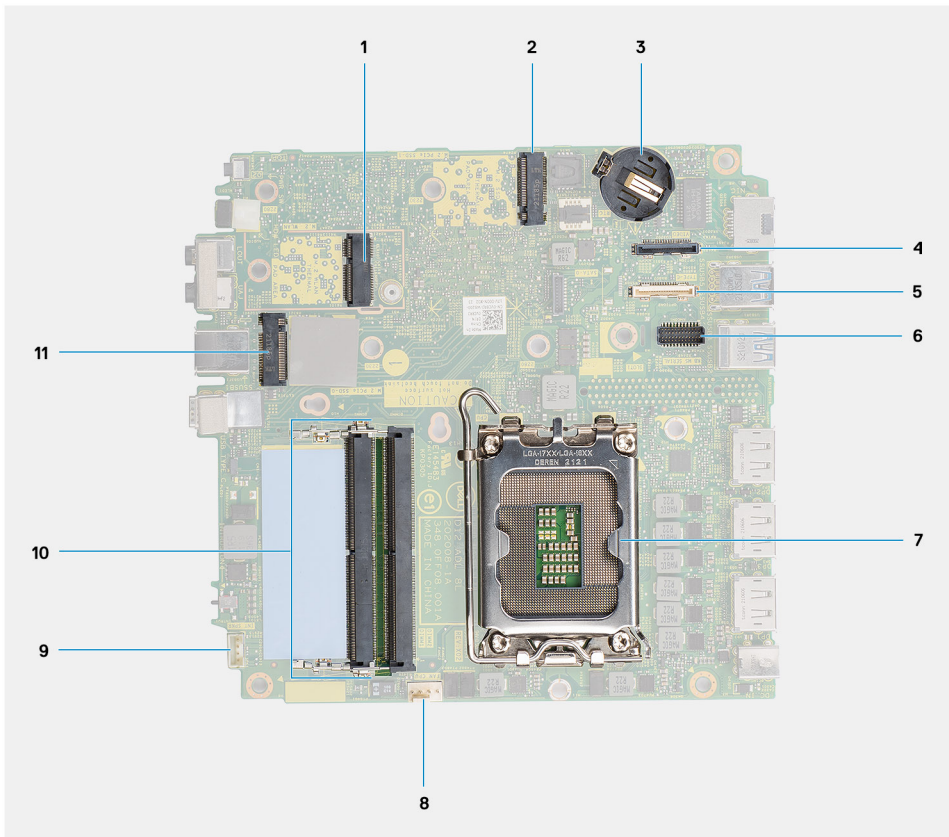

- |                       |   |
|-----------------------|---|
| 1. M.2 WLAN connector | 2. M.2 SSD PCIe connector (2230/2280)   |
| 3. Coin-cell battery  | 4. Optional video connector (VGA Port/DisplayPort 1.4a (HBR3)/HDMI 2.0b Port) |



- 5. Optional connector (USB 3.2 Gen 2 Type-C Port)
- 6. Optional PS/2, serial port connector
- 7. Processor socket
- 8. Fan connector
- 9. Internal speaker connector
- 10. Memory module slots

**35 W system board**

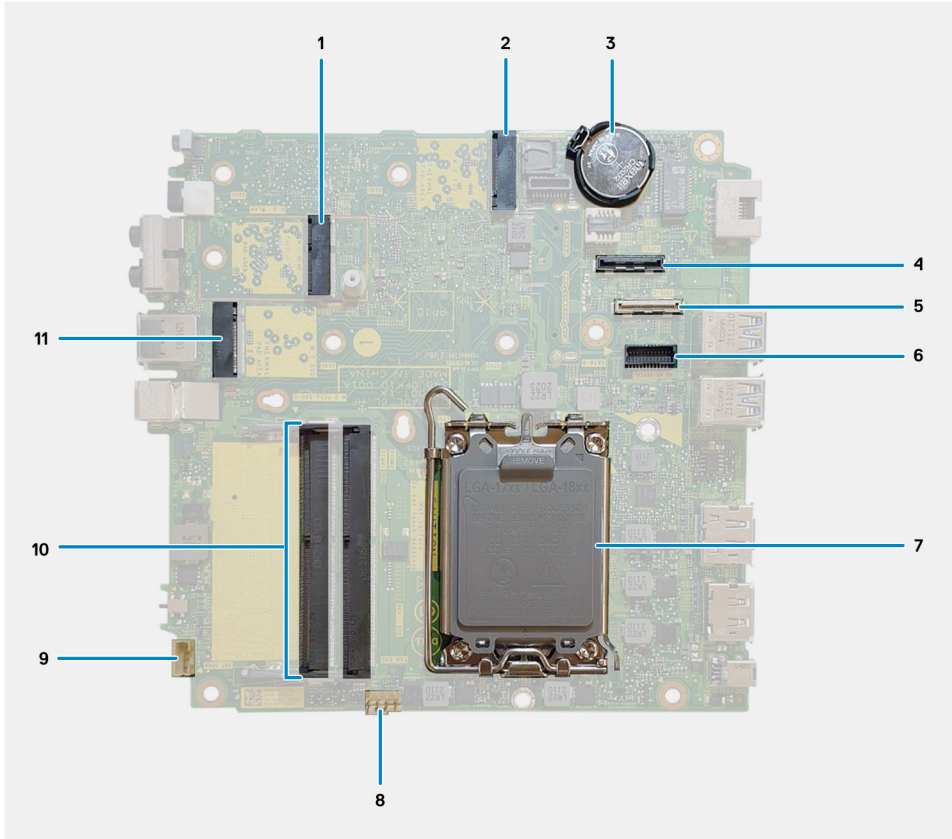

- 1. M.2 WLAN connector
- 2. M.2 SSD PCIe connector (2230/2280)
- 3. Coin-cell battery
- 4. Optional video connector (VGA Port/DisplayPort 1.4a (HBR3)/HDMI 2.0b Port)
- 5. Optional connector (USB 3.2 Gen 2 Type-C Port)
- 6. Optional PS/2, serial port connector
- 7. Processor socket
- 8. Fan connector
- 9. Internal speaker connector
- 10. Memory module slots
- 11. M.2 SSD PCIe connector (2230/2280)



5x  
M3x5



3x  
M3x4L

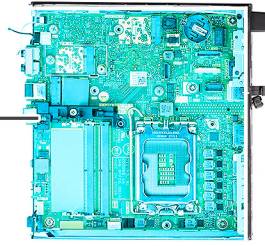

1

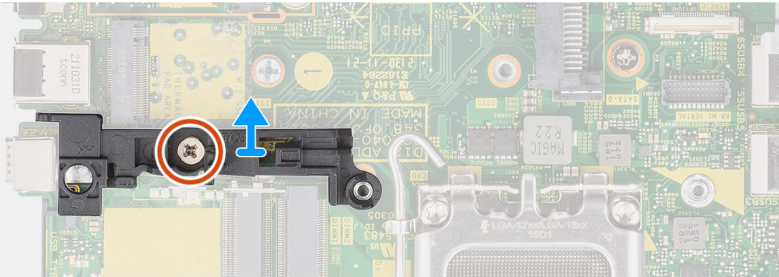

2

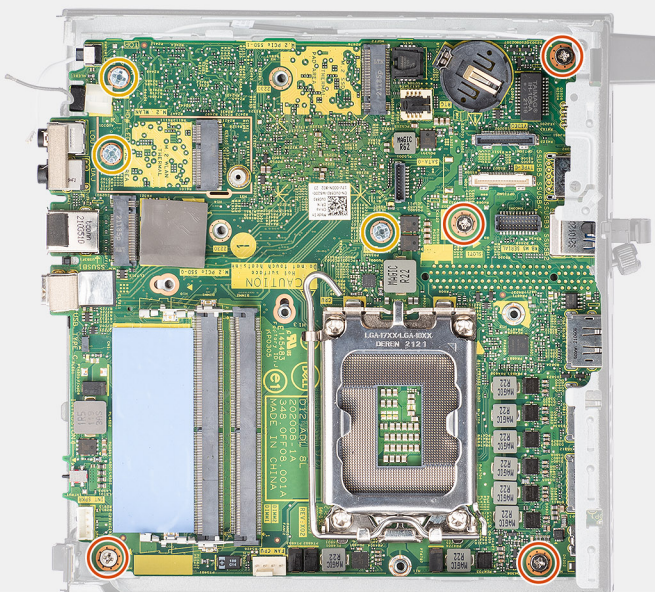

3

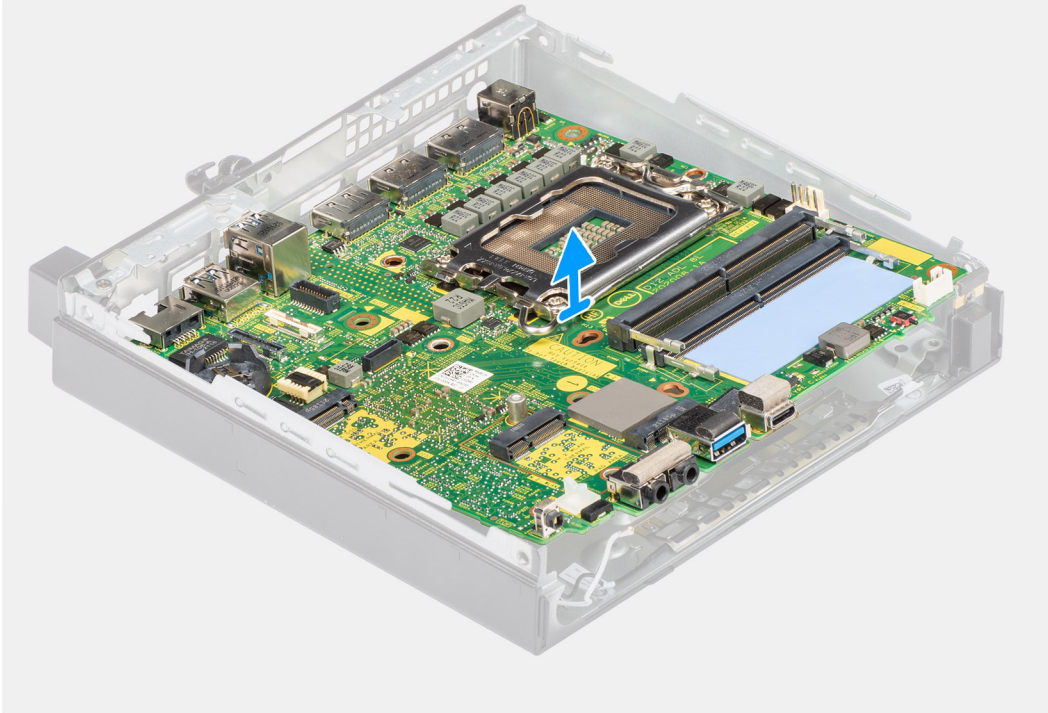

### Steps

1. Remove the screw (M3x5) that secures the speaker support to the system board.
2. Lift the speaker support away from the system board.
3. Remove the four (M3x5) screws and three (M3x4L) screws that secure the system board to the chassis.
4. Lift the system board away from the chassis.

## Installing the system board

### Prerequisites

If you are replacing a component, remove the existing component before performing the installation procedure.

### About this task

The following image indicates the location of the system board and provides a visual representation of the installation procedure.



1

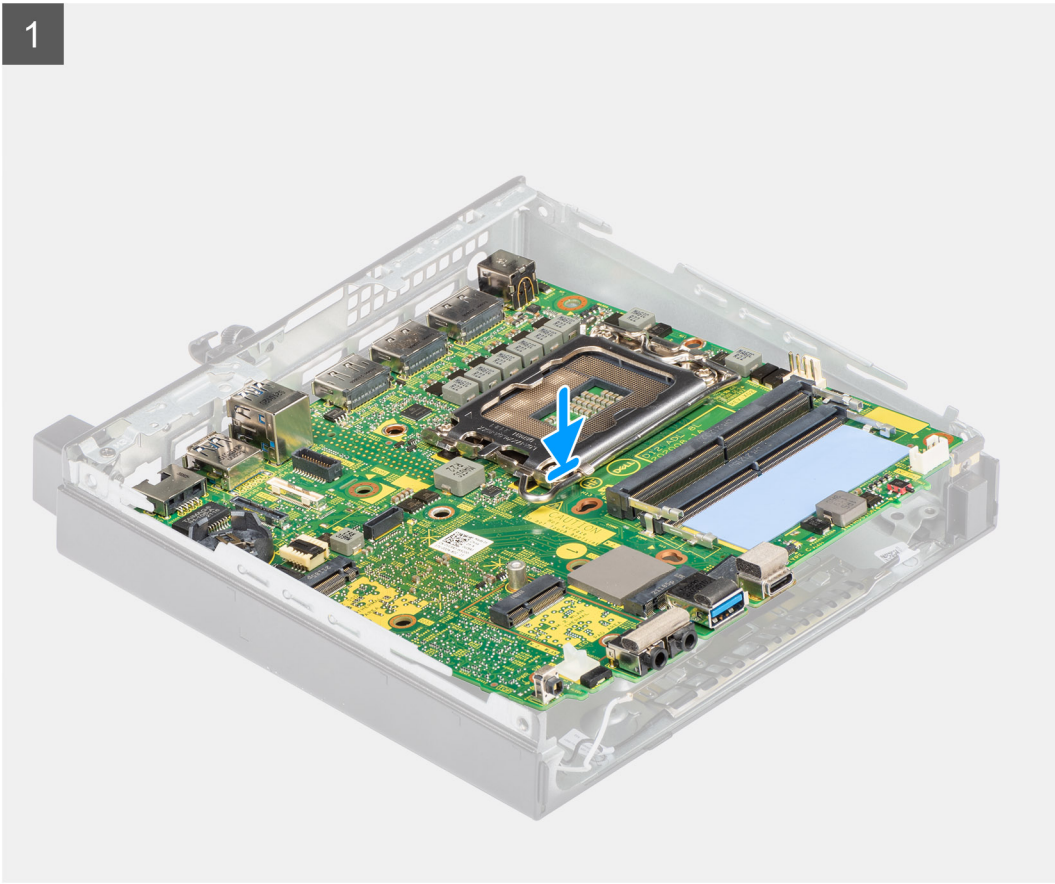



5x  
M3x5



3x  
M3x4L

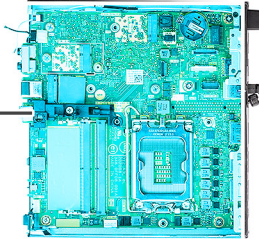

2

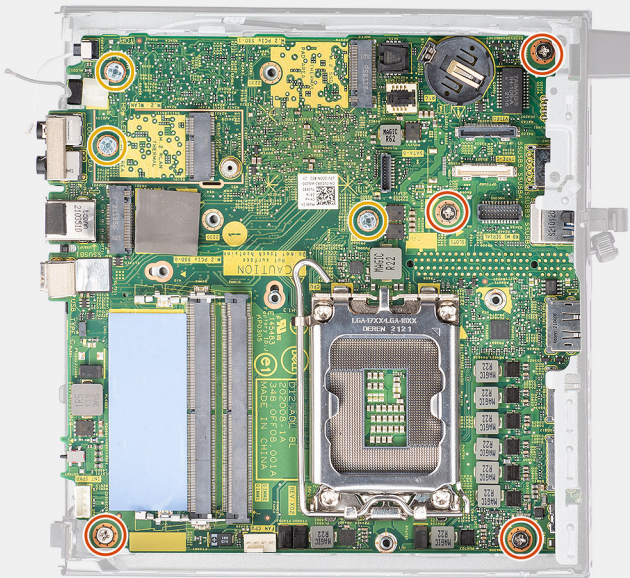

3

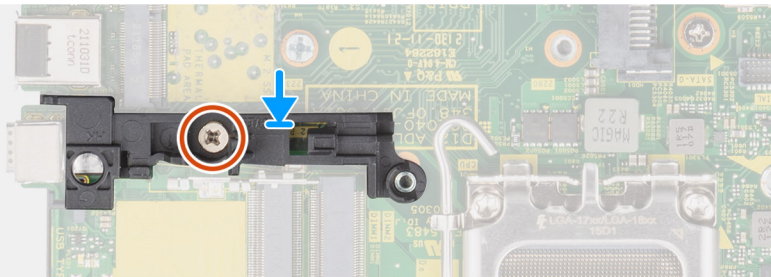

### Steps

1. Align and lower the system board into the system until the connectors at the back of the system board align with the slots on the chassis, and the screw holes on the system board align with the standoffs on the system.
2. Replace the four (M3x5) screws and three (M3x4L) screws that secure the system board to the chassis.
3. Align the slot on the speaker support with system board and place the speaker support on the system board.
4. Replace the screw (M3x5) to secure the speaker support to the system board.

### Next steps

1. Install the [processor](#).
2. Install the [speaker](#).
3. Install the [memory module](#).
4. Install the [heat sink](#).
5. Install the [fan assembly](#).
6. Install the [WLAN card](#).
7. Install the [solid-state drive](#).
8. Install the [side cover](#).
9. Follow the procedure in [after working inside your computer](#).

## Drivers and downloads

When troubleshooting, downloading or installing drivers it is recommended that you read the Dell Knowledge Based article, Drivers and Downloads FAQ [000123347](#).

# BIOS setup

**CAUTION:** Unless you are an expert computer user, do not change the settings in the BIOS Setup program. Certain changes can make your computer work incorrectly.

**NOTE:** Depending on the computer and its installed devices, the items listed in this section may or may not be displayed.

**NOTE:** Before you change BIOS Setup program, it is recommended that you write down the BIOS Setup program screen information for future reference.

Use the BIOS Setup program for the following purposes:

- Get information about the hardware installed in your computer, such as the amount of RAM and the size of the hard drive.
- Change the system configuration information.
- Set or change a user-selectable option, such as the user password, type of hard drive installed, and enabling or disabling base devices.

## Entering BIOS setup program

### About this task

Turn on (or restart) your computer and press F2 immediately.

## Navigation keys

**NOTE:** For most of the System Setup options, changes that you make are recorded but do not take effect until you restart the system.

**Table 3. Navigation keys**

Keys	Navigation
Up arrow	Moves to the previous field.
Down arrow	Moves to the next field.
Enter	Selects a value in the selected field (if applicable) or follow the link in the field.
Spacebar	Expands or collapses a drop-down list, if applicable.
Tab	Moves to the next focus area. <b>NOTE:</b> For the standard graphics browser only.
Esc	Moves to the previous page until you view the main screen. Pressing Esc in the main screen displays a message that prompts you to save any unsaved changes and restarts the system.

## One time boot menu

To enter **one time boot menu**, turn on your computer, and then press F12 immediately.

**NOTE:** It is recommended to shutdown the computer if it is on.

The one-time boot menu displays the devices that you can boot from including the diagnostic option. The boot menu options are:

- Removable Drive (if available)
- STXXXX Drive (if available)
- **i** **NOTE:** XXX denotes the SATA drive number.
- Optical Drive (if available)
- SATA Hard Drive (if available)
- Diagnostics

The boot sequence screen also displays the option to access the System Setup screen.

## System setup options

**i** **NOTE:** Depending on your computer and its installed devices, the items that are listed in this section may or may not appear.

**Table 4. System setup options—System information menu**

Overview	
<b>OptiPlex 7000 Micro</b>	
BIOS Version	Displays the BIOS version number.
Service Tag	Displays the Service Tag of the computer.
Asset Tag	Displays the Asset Tag of the computer.
Manufacture Date	Displays the manufacture date of the computer.
Ownership Date	Displays the ownership date of the computer.
Express Service Code	Displays the express service code of the computer.
Ownership Tag	Displays the Ownership Tag of the computer.
Signed Firmware Update	Displays whether the Signed Firmware Update is enabled on your computer.
<b>Processor Information</b>	
Processor Type	Displays the processor type.
Maximum Clock Speed	Displays the maximum processor clock speed.
Minimum Clock Speed	Displays the minimum processor clock speed.
Current Clock Speed	Displays the current processor clock speed.
Core Count	Displays the number of cores on the processor.
Processor ID	Displays the processor identification code.
Processor L2 Cache	Displays the processor L2 Cache size.
Processor L3 Cache	Displays the processor L3 Cache size.
Microcode Version	Displays the microcode version.
Intel Hyper-Threading Capable	Displays whether the processor is Hyper-Threading (HT) capable.
64-Bit Technology	Displays whether 64-bit technology is used.
<b>Memory Information</b>	
Memory Installed	Displays the total computer memory installed.
Memory Available	Displays the total computer memory available.
Memory Speed	Displays the memory speed.
Memory Channel Mode	Displays single or dual channel mode.
Memory Technology	Displays the technology that is used for the memory.

**Table 4. System setup options—System information menu (continued)**

<b>Overview</b>	
DIMM 1 Size	Displays the DIMM 1 memory size.
DIMM 2 Size	Displays the DIMM 2 memory size.
DIMM 3 Size	Displays the DIMM 3 memory size.
DIMM 4 Size	Displays the DIMM 4 memory size.
<b>Devices Information</b>	
Video Controller	Displays the video controller type of the computer.
Video Memory	Displays the video memory information of the computer.
Wi-Fi Device	Displays the wireless device information of the computer.
Native Resolution	Displays the native resolution of the computer.
Video BIOS Version	Displays the video BIOS version of the computer.
Audio Controller	Displays the audio controller information of the computer.
Bluetooth Device	Displays the Bluetooth device information of the computer.
LOM MAC Address	Displays the LAN On Motherboard (LOM) MAC address of the computer.
dGPU Video Controller	Displays the discrete video controller type of the computer.
Slot 1	Displays the SATA hard drive information of the computer.
Slot 2	Displays the SATA hard drive information of the computer.
Slot 3	Displays the SATA hard drive information of the computer.
Slot 4	Displays the SATA hard drive information of the computer.

**Table 5. System setup options—Boot Configuration menu**

<b>Boot Configuration</b>	
<b>Boot Sequence</b>	
Boot Mode: UEFI only	Displays the boot mode.
Boot Sequence	Displays the boot sequence.
<b>Secure Digital (SD) Card Boot</b>	Enable or disable the SD card read-only boot. By default, the <b>Secure Digital (SD) Card Boot</b> option is not enabled.
<b>Secure Boot</b>	
Enable Secure Boot	Enable or disable the secure boot feature. By default, the option is not enabled.
Secure Boot Mode	Enable or disable to change the secure boot mode options. By default, the <b>Deployed Mode</b> is enabled.
<b>Expert Key Management</b>	
Enable Custom Mode	Enable or disable custom mode. By default, the <b>custom mode</b> option is not enabled.
Custom Mode Key Management	Select the custom values for expert key management.

**Table 6. System setup options—Integrated Devices menu**

<b>Integrated Devices</b>	
<b>Date/Time</b>	Displays the current date in MM/DD/YYYY format and current time in HH:MM:SS AM/PM format.



**Table 6. System setup options—Integrated Devices menu (continued)**

<b>Integrated Devices</b>	
<b>Audio</b>	
Enable Audio	Enable or disable the integrated audio controller. By default, all the options are enabled.
<b>Serial Port</b>	
Serial Port Configuration	Enable or disable the serial port address. By default, the <b>COM1: Port is configured at 3F8h with IRQ4</b> option is enabled.
<b>USB Configuration</b>	
	<ul style="list-style-type: none"> <li>Enable or disable booting from USB mass storage devices through the boot sequence or boot menu.</li> </ul> By default, all the options are enabled.
<b>Front USB Configuration</b>	
	Enable or disable the individual front USB ports. By default, all the options are enabled.
<b>Rear USB Configuration</b>	
	Enable or disable the individual rear USB ports. By default, all the options are enabled.
<b>Dust Filter Maintenance</b>	
	Enable or disable the dust filter maintenance. By default, the <b>Disabled</b> option is enabled.

**Table 7. System setup options—Storage menu**

<b>Storage</b>	
<b>SATA Operation</b>	
	Enable or disable the operating mode of the integrated SATA hard drive controller. By default, the option is enabled.
<b>Storage Interface</b>	
Port Enablement	Enable or disable the onboard drives. By default, all the options are enabled.
<b>SMART Reporting</b>	
Enable SMART Reporting	Enable or disable Self-Monitoring, Analysis, and Reporting Technology (SMART) during computer startup. By default, the <b>Enable SMART Reporting</b> option is not enabled.
<b>Drive Information</b>	
<b>SATA-0</b>	
Type	Displays the SATA HDD type information of the computer.
Device	Displays the SATA HDD device information of the computer.
<b>SATA-1</b>	
Type	Displays the SATA HDD type information of the computer.
Device	Displays the SATA HDD device information of the computer.
<b>SATA-2</b>	
Type	Displays the SATA HDD type information of the computer.
Device	Displays the SATA HDD device information of the computer.
<b>SATA-3</b>	

**Table 7. System setup options—Storage menu (continued)**

Storage	
Type	Displays the SATA HDD type information of the computer.
Device	Displays the SATA HDD device information of the computer.
<b>M.2 PCIe SSD-0</b>	
Type	Displays the M.2 PCIe SSD-0 type information of the computer.
Device	Displays the M.2 PCIe SSD-0 device information of the computer.
<b>Enable MediaCard</b>	
Secure Digital (SD) Card	Enable or disable the SD card. By default, the <b>Secure Digital (SD) Card</b> option is enabled.
Secure Digital (SD) Card Read-Only Mode	Enable or disable the SD card read-only mode. By default, the <b>Secure Digital (SD) Card Read-Only Mode</b> option is not enabled.

**Table 8. System setup options—Display menu**

Display	
<b>Multi-Display</b>	
Enable Multi-Display	Enable or disable the Enable Multi-Display buttons on the computer. By default, the option is enabled.
<b>Primary Display</b>	
Video Primary Display	Determines the primary display when multiple controllers are available on the computer By default, the <b>Auto</b> option is enabled.
<b>Full Screen Logo</b>	
	Enable or disable full screen logo. By default, the option is not enabled.

**Table 9. System setup options—Connection menu**

Connection	
<b>Network Controller Configuration</b>	
Integrated NIC	Controls the on-board LAN controller. By default, the <b>Enabled with PXE</b> option is enabled.
<b>Wireless Device Enable</b>	
WLAN	Enable or disable the internal WLAN device By default, the option enabled.
Bluetooth	Enable or disable the internal Bluetooth device By default, the option enabled.
<b>Enable UEFI Network Stack</b>	
	Enable or disable UEFI Network Stack and controls the on-board LAN Controller. By default, the option is enabled.
<b>HTTPs Boot Feature</b>	
HTTPs Boot	Enable or disable the HTTPs Boot feature. By default, the <b>HTTPs Boot</b> option is enabled.

**Table 9. System setup options—Connection menu (continued)**

Connection	
HTTPs Boot Mode	With Auto Mode, the HTTPs Boot extracts Boot URL from the DHCP. With Manual Mode, the HTTPs Boot reads Boot URL from the user-provided data.  By default, the <b>Auto Mode</b> option is enabled.

**Table 10. System setup options—Power menu**

Power	
<b>USB PowerShare</b>	
Enable USB PowerShare	Enable or disable the USB PowerShare.  By default, the <b>Enable USB PowerShare</b> option is enabled
<b>USB Wake Support</b>	
Enable USB Wake Support	When enabled, you can use the USB devices like a mouse or keyboard to wake your computer from standby.  By default, the option is enabled.
<b>AC Behavior</b>	
AC Recovery	Enables the system to turn on automatically, when AC is inserted.  By default, the <b>Power Off</b> option is enabled.
<b>Active State Power Management</b>	
Aspm	Enables or disables the Active State Power Management (ASPM) level  By default, the <b>Auto</b> option is enabled.
<b>Block Sleep</b>	
	Enables to block entering sleep (S3) mode in the operating system.  By default, the <b>Block Sleep</b> option is disabled.
<b>Deep Sleep Control</b>	
	Enable or disable the Deep Sleep mode support.  By default, the <b>Disabled</b> option is enabled.
<b>Fan Control Override</b>	
	Enable or disable the fan control override feature.  By default, the option is disabled.
<b>Intel Speed Shift Technology</b>	
	Enable or disable the Intel speed shift technology support.  By default, the <b>Intel Speed Shift Technology</b> option is enabled.

**Table 11. System setup options—Security menu**

Security	
<b>TPM 2.0 Security</b>	
TPM 2.0 Security On	Enable or disable TPM 2.0 security options.  By default, the <b>TPM 2.0 Security On</b> option is enabled.
Attestation Enable	Enables to control whether the Trusted Platform Module (TPM) Endorsement Hierarchy is available to the operating system.  By default, the <b>Attestation Enable</b> option is enabled.
Key Storage Enable	Enables to control whether the Trusted Platform Module (TPM) Storage Hierarchy is available to the operating system.  By default, the <b>Key Storage Enable</b> option is enabled.
SHA-256	BIOS and the TPM will use the SHA-256 hash algorithm to extend measurements into the TPM PCRs during BIOS boot.

**Table 11. System setup options—Security menu (continued)**

<b>Security</b>	
	By default, the <b>SHA-256</b> option is enabled.
Clear	Enables to clear the TPM owner information and returns the TPM to the default state. By default, the <b>Clear</b> option is disabled.
PPI ByPass for Clear Commands	Controls the TPM Physical Presence Interface (PPI). By default, the <b>PPI ByPass for clear Commands</b> option is disabled.
<b>Chassis intrusion</b>	Controls the chassis intrusion feature. By default, the option is disabled.
<b>SMM Security Mitigation</b>	Enable or disable SMM Security Mitigation. By default, the option is enabled.
<b>Data Wipe on Next Boot</b>	
Start Data Wipe	Enable or disable the data wipe on next boot. By default, the option is disabled.
Absolute	Enable or disable or permanently disable the BIOS module interface of the optional Absolute Persistence Module service from Absolute software. By default, the <b>Enable Absolute</b> option is enabled.
UEFI Boot Path Security	Controls whether or not the computer will prompt the user to enter the admin password (if set) when booting to a UEFI boot device from the F12 boot menu. By default, the <b>Always Except Internal HDD</b> option is enabled.

**Table 12. System setup options—Passwords menu**

<b>Passwords</b>	
<b>Admin Password</b>	Set, change, or delete the administrator password.
<b>System Password</b>	Set, change, or delete the computer password.
<b>Internal HDD-0 Password</b>	Set, change, or delete the Internal HDD-0 password.
<b>NVMe SSD0</b>	Set, change, or delete the NVMe SSD0 password.
<b>Password Configuration</b>	
Upper Case Letter	Reinforces password must have at least one upper case letter. By default, the option is disabled.
Lower Case Letter	Reinforces password must have at least one lower case letter. By default, the option is disabled.
Digit	Reinforces password must have at least one digit. By default, the option is disabled.
Special Character	Reinforces password must have at least one special character. By default, the option is disabled.
Minimum Characters	Set the minimum characters allowed for password.
Password Bypass	When enabled, this always prompts for computer and internal hard drive passwords when powered on from the off state. By default, the <b>Disabled</b> option is enabled.
<b>Password Changes</b>	

**Table 12. System setup options—Passwords menu (continued)**

<b>Passwords</b>	
Enable Non-Admin Password Changes	Enable or disable to change computer and hard drive password without the need for admin password.  By default, the option is enabled.
<b>Admin Setup Lockout</b>	
Enable Admin Setup Lockout	Enables administrators control over how their users can or cannot access BIOS setup.  By default, the option is disabled.
<b>Master Password Lockout</b>	
Enable Master Password Lockout	When enabled, this will disable the master password support.  By default, the option is disabled.
<b>Allow Non-Admin PSID Revert</b>	
Enable Allow Non-Admin PSID Revert	Controls access to the Physical Security ID (PSID) revert of NVMe hard-drives from the Dell Security Manager prompt.  By default, the option is disabled.

**Table 13. System setup options—Update, Recovery menu**

<b>Update, Recovery</b>	
<b>UEFI Capsule Firmware Updates</b>	Enable or disable BIOS updates through UEFI capsule update packages.  By default, the option is enabled.
<b>BIOS Recovery from Hard Drive</b>	Enables the user to recover from certain corrupted BIOS conditions from a recovery file on the user primary hard drive or an external USB key.  By default, the option is enabled.
<b>BIOS Downgrade</b>	
Allow BIOS Downgrade	Enable or disable the flashing of the computer firmware to previous revision is blocked.  By default, the option is enabled.
<b>SupportAssist OS Recovery</b>	Enable or disable the boot flow for SupportAssist OS Recovery tool in the event of certain computer errors.  By default, the option is enabled.
<b>BIOSConnect</b>	Enable or disable cloud Service OS recovery if the main operating system fails to boot with the number of failures equal to or greater than the value specified by the Auto OS Recovery Threshold setup option and local Service OS does not boot or is not installed.  By default, the option is enabled.
<b>Dell Auto OS Recovery Threshold</b>	Controls the automatic boot flow for SupportAssist System Resolution Console and for Dell OS Recovery Tool.  By default, the threshold value is set to 2.

**Table 14. System setup options—System Management menu**

<b>System Management</b>	
<b>Service Tag</b>	Display the Service Tag of the computer.
<b>Asset Tag</b>	Create a computer Asset Tag.



**Table 14. System setup options—System Management menu (continued)**

<b>System Management</b>	
<b>Wake on LAN/WLAN</b>	Enable or disable the computer to power on by special LAN signals when it receives a wakeup signal from the WLAN.  By default, the <b>Disabled</b> option is selected.
<b>Auto on Time</b>	Enable to set the computer to turn on automatically every day or on a preselected date and time. This option can be configured only if the Auto On Time is set to Everyday, Weekdays, or Selected Days.  By default, the option is disabled.
<b>Intel AMT Capability</b>	Enable Intel AMT Capability
	Enable or disable the Intel AMT capability.  By default, the <b>Restrict MEBx Access</b> option is enabled.
<b>MEBx Hotkey</b>	Enable or disable MEBx hotkey.  By default, the option is disabled.
<b>USB Provision</b>	Enable USB Provision
	Enable or disable the Intel AMT provisioning using the local provisioning file through a USB storage device.  By default, the option is disabled.
<b>SERR Messages</b>	Enable or disable SERR messages.  By default, the option is enabled.

**Table 15. System setup options—Keyboard menu**

<b>Keyboard</b>	
<b>Keyboard Errors</b>	Enable Keyboard Error Detection
	Enable or disable the keyboard error detection.  By default, the option is enabled.
<b>Numlock LED</b>	Enable Numlock LED
	Enable or disable Numlock LED.  By default, the option is enabled.
<b>Device Configuration Hotkey Access</b>	Device Configuration Hotkey Access
	Enable or disable users to access device configuration by using hotkeys.  By default, the option is enabled.

**Table 16. System setup options—Pre-boot Behavior menu**

<b>Pre-boot Behavior</b>	
<b>Warning and Errors</b>	Enable or disable the action to be done when a warning or error is encountered.  By default, the <b>Prompt on Warnings and Errors</b> option is enabled.
<b>Fastboot</b>	Enable to set the speed of the boot process.  By default, the option is enabled.
<b>Extend BIOS POST Time</b>	Set the BIOS POST time.  By default, the <b>0 seconds</b> option is enabled.

**Table 17. System setup options—Virtualization menu**

Virtualization	
<b>Intel Virtualization Technology</b>	
Enable Intel Virtualization Technology (VT)	Specify whether a Virtual Machine Monitor (VMM) can utilize the additional hardware capabilities that are provided by Intel Virtualization Technology.  By default, the option is enabled.
<b>VT for Direct I/O</b>	
	Specify whether a Virtual Machine Monitor (VMM) can utilize the additional hardware capabilities that are provided by Intel Virtualization Technology for Direct I/O.  By default, the option is enabled.
<b>Intel Trusted Execution Technology (TXT)</b>	
Enable Intel Trusted Execution Technology (TXT)	Specifies whether a measured Virtual Machine Monitor (MVMM) can utilize the additional hardware capabilities that are provided by Intel Trusted Execution Technology.  By default, the option is disabled.

**Table 18. System setup options—Performance menu**

Performance	
<b>Multi Core Support</b>	
Active Cores	Enables to change the number of CPU cores available to the operating system.  By default, the <b>All Cores</b> options are enabled.
<b>Intel SpeedStep</b>	
Enable Intel SpeedStep Technology	Enables the computer to dynamically adjust processor voltage and core frequency, decreasing average power consumption and heat production.  By default, the option is enabled.
<b>C-States Control</b>	
Enable C-State Control	Enable or disable additional processor sleep states.  By default, the option is enabled.
<b>Intel Turbo Boost Technology</b>	
Enable Intel Turbo Boost Technology	Enable or disable Intel TurboBoost mode of the processor.  By default, the option is enabled.
<b>Intel Hyper-Threading Technology</b>	
Enable Intel Hyper-Threading Technology	Enable or disable Hyper-Threading in the processor.  By default, the option is enabled.

**Table 19. System setup options—System Logs menu**

System Logs	
<b>BIOS Event Log</b>	
Clear BIOS Event Log	Display BIOS events.  By default, the <b>Keep</b> option is enabled.

# Updating the BIOS

## Updating the BIOS in Windows

### About this task

 **CAUTION:** If BitLocker is not suspended before updating the BIOS, the next time you reboot the system it will not recognize the BitLocker key. You will then be prompted to enter the recovery key to progress and the system will ask for this on each reboot. If the recovery key is not known this can result in data loss or an unnecessary operating system re-install. For more information on this subject, search in the Knowledge Base Resource at [www.dell.com/support](http://www.dell.com/support).

### Steps

1. Go to [www.dell.com/support](http://www.dell.com/support).
2. Click **Product support**. In the **Search support** box, enter the Service Tag of your computer, and then click **Search**.  
 **NOTE:** If you do not have the Service Tag, use the SupportAssist feature to automatically identify your computer. You can also use the product ID or manually browse for your computer model.
3. Click **Drivers & Downloads**. Expand **Find drivers**.
4. Select the operating system installed on your computer.
5. In the **Category** drop-down list, select **BIOS**.
6. Select the latest version of BIOS, and click **Download** to download the BIOS file for your computer.
7. After the download is complete, browse the folder where you saved the BIOS update file.
8. Double-click the BIOS update file icon and follow the on-screen instructions.  
For more information, search in the Knowledge Base Resource at [www.dell.com/support](http://www.dell.com/support).

## Updating the BIOS in Linux and Ubuntu

To update the system BIOS on a computer that is installed with Linux or Ubuntu, see the knowledge base article [000131486](https://www.dell.com/support) at [www.dell.com/support](http://www.dell.com/support).

## Updating the BIOS using the USB drive in Windows

### About this task

 **CAUTION:** If BitLocker is not suspended before updating the BIOS, the next time you reboot the system it will not recognize the BitLocker key. You will then be prompted to enter the recovery key to progress and the system will ask for this on each reboot. If the recovery key is not known this can result in data loss or an unnecessary operating system re-install. For more information on this subject, search in the Knowledge Base Resource at [www.dell.com/support](http://www.dell.com/support).

### Steps

1. Follow the procedure from step 1 to step 6 in [Updating the BIOS in Windows](#) to download the latest BIOS setup program file.
2. Create a bootable USB drive. For more information, search in the Knowledge Base Resource at [www.dell.com/support](http://www.dell.com/support).
3. Copy the BIOS setup program file to the bootable USB drive.
4. Connect the bootable USB drive to the computer that needs the BIOS update.
5. Restart the computer and press **F12**.
6. Select the USB drive from the **One Time Boot Menu**.
7. Type the BIOS setup program filename and press **Enter**.  
The **BIOS Update Utility** appears.
8. Follow the on-screen instructions to complete the BIOS update.

# Updating the BIOS from the F12 One-Time boot menu

Update your computer BIOS using the BIOS update.exe file that is copied to a FAT32 USB drive and booting from the F12 One-Time boot menu.

## About this task

**CAUTION:** If BitLocker is not suspended before updating the BIOS, the next time you reboot the system it will not recognize the BitLocker key. You will then be prompted to enter the recovery key to progress and the system will ask for this on each reboot. If the recovery key is not known this can result in data loss or an unnecessary operating system re-install. For more information on this subject, search in the Knowledge Base Resource at [www.dell.com/support](http://www.dell.com/support).

## BIOS Update

You can run the BIOS update file from Windows using a bootable USB drive or you can also update the BIOS from the F12 One-Time boot menu on the computer.

Most of the Dell computers built after 2012 have this capability, and you can confirm by booting your computer to the F12 One-Time Boot Menu to see if BIOS FLASH UPDATE is listed as a boot option for your computer. If the option is listed, then the BIOS supports this BIOS update option.

**NOTE:** Only computers with BIOS Flash Update option in the F12 One-Time boot menu can use this function.

## Updating from the One-Time boot menu

To update your BIOS from the F12 One-Time boot menu, you need the following:

- USB drive formatted to the FAT32 file system (key does not have to be bootable)
- BIOS executable file that you downloaded from the Dell Support website and copied to the root of the USB drive
- AC power adapter that is connected to the computer
- Functional computer battery to flash the BIOS

Perform the following steps to perform the BIOS update flash process from the F12 menu:

**CAUTION:** Do not turn off the computer during the BIOS update process. The computer may not boot if you turn off your computer.

## Steps

1. From a turn off state, insert the USB drive where you copied the flash into a USB port of the computer.
2. Turn on the computer and press F12 to access the One-Time Boot Menu, select BIOS Update using the mouse or arrow keys then press Enter.  
The flash BIOS menu is displayed.
3. Click **Flash from file**.
4. Select external USB device.
5. Select the file and double-click the flash target file, and then click **Submit**.
6. Click **Update BIOS**. The computer restarts to flash the BIOS.
7. The computer will restart after the BIOS update is completed.

# System and setup password

Table 20. System and setup password

Password type	Description
System password	Password that you must enter to log in to your system.
Setup password	Password that you must enter to access and make changes to the BIOS settings of your computer.

You can create a system password and a setup password to secure your computer.

 **CAUTION:** The password features provide a basic level of security for the data on your computer.

 **CAUTION:** Anyone can access the data that is stored on your computer if it is not locked and left unattended.

 **NOTE:** System and setup password feature is disabled.

## Assigning a system setup password

### Prerequisites

You can assign a new **System or Admin Password** only when the status is in **Not Set**.

### About this task

To enter the system setup, press F12 immediately after a power-on or reboot.

### Steps

1. In the **System BIOS** or **System Setup** screen, select **Security** and press Enter.  
The **Security** screen is displayed.
2. Select **System/Admin Password** and create a password in the **Enter the new password** field.  
Use the following guidelines to assign the system password:
  - A password can have up to 32 characters.
  - At least one special character: ! " # \$ % & ' ( ) \* + , - . / : ; < = > ? @ [ \ ] ^ \_ ` { | }
  - Numbers 0 through 9.
  - Upper case letters from A to Z.
  - Lower case letters from a to z.
3. Type the system password that you entered earlier in the **Confirm new password** field and click **OK**.
4. Press Esc and save the changes as prompted by the pop-up message.
5. Press Y to save the changes.  
The computer restarts.

## Deleting or changing an existing system setup password

### Prerequisites

Ensure that the **Password Status** is Unlocked (in the System Setup) before attempting to delete or change the existing System and/or Setup password. You cannot delete or change an existing System or Setup password, if the **Password Status** is Locked.

### About this task

To enter the System Setup, press F12 immediately after a power-on or reboot.

### Steps

1. In the **System BIOS** or **System Setup** screen, select **System Security** and press Enter.  
The **System Security** screen is displayed.
2. In the **System Security** screen, verify that **Password Status** is **Unlocked**.
3. Select **System Password**, update, or delete the existing system password, and press Enter or Tab.
4. Select **Setup Password**, update, or delete the existing setup password, and press Enter or Tab.  
 **NOTE:** If you change the System and/or Setup password, reenter the new password when prompted. If you delete the System and/or Setup password, confirm the deletion when prompted.
5. Press Esc and a message prompts you to save the changes.
6. Press Y to save the changes and exit from System Setup.  
The computer restarts.



# Clearing BIOS (System Setup) and System passwords

## About this task

To clear the system or BIOS passwords, contact Dell technical support as described at [www.dell.com/contactdell](http://www.dell.com/contactdell).

 **NOTE:** For information on how to reset Windows or application passwords, refer to the documentation accompanying Windows or your application.

# Troubleshooting

## Dell SupportAssist Pre-boot System Performance Check diagnostics

### About this task

SupportAssist diagnostics (also known as system diagnostics) performs a complete check of your hardware. The Dell SupportAssist Pre-boot System Performance Check diagnostics is embedded with the BIOS and is launched by the BIOS internally. The embedded system diagnostics provides a set of options for particular devices or device groups allowing you to:

- Run tests automatically or in an interactive mode
- Repeat tests
- Display or save test results
- Run thorough tests to introduce additional test options to provide extra information about the failed device(s)
- View status messages that inform you if tests are completed successfully
- View error messages that inform you of problems encountered during testing

 **NOTE:** Some tests for specific devices require user interaction. Always ensure that you are present at the computer terminal when the diagnostic tests are performed.

For more information, see <https://www.dell.com/support/kbdoc/000180971>.

## Running the SupportAssist Pre-Boot System Performance Check

### Steps

1. Turn on your computer.
2. As the computer boots, press the F12 key as the Dell logo appears.
3. On the boot menu screen, select the **Diagnostics** option.
4. Click the arrow at the bottom left corner.  
Diagnostics front page is displayed.
5. Click the arrow in the lower-right corner to go to the page listing.  
The items detected are listed.
6. To run a diagnostic test on a specific device, press Esc and click **Yes** to stop the diagnostic test.
7. Select the device from the left pane and click **Run Tests**.
8. If there are any issues, error codes are displayed.  
Note the error code and validation number and contact Dell.

## Power-Supply Unit Built-in Self-Test

Built-in Self-Test (BIST) helps determine if the power-supply unit is working. To run self-test diagnostics on the power-supply unit of a desktop or all-in-one computer, search in the Knowledge Base Resource at [www.dell.com/support](http://www.dell.com/support).

# System-diagnostic lights

This section lists the system-diagnostic lights of your OptiPlex 7000 Micro.

**Table 21. System-diagnostic lights**

Blinking pattern		Problem description	Suggested resolution
Amber	White		
1	1	TPM detection failure	Replace the system board.
1	2	Unrecoverable SPI Flash Failure	Replace the system board.
1	5	EC unable to program i-Fuse	Replace the system board.
1	6	Generic catch-all for ungraceful EC code flow errors	Disconnect all power source (AC, battery, coin cell) and drain flea power by pressing and holding down power button for 3~5 seconds.
2	1	CPU failure	<ul style="list-style-type: none"> <li>• Run the Dell Support Assist/Dell Diagnostics tool.</li> <li>• If problem persists, replace the system board.</li> </ul>
2	2	System board failure (included BIOS corruption or ROM error)	<ul style="list-style-type: none"> <li>• Flash latest BIOS version</li> <li>• If problem persists, replace the system board.</li> </ul>
2	3	No memory/RAM detected	<ul style="list-style-type: none"> <li>• Confirm that the memory module is installed properly.</li> <li>• If problem persists, replace the memory module.</li> </ul>
2	4	Memory/RAM failure	<ul style="list-style-type: none"> <li>• Reset and swap memory modules among the slots.</li> <li>• If problem persists, replace the memory module.</li> </ul>
2	5	Invalid memory installed	<ul style="list-style-type: none"> <li>• Reset and swap memory modules among the slots.</li> <li>• If problem persists, replace the memory module.</li> </ul>
2	6	System board/Chipset Error	Replace the system board.
2	7	LCD failure (SBIOS message)	Replace the LCD module.
2	8	LCD failure (EC detection of power rail failure)	Replace the system board.
3	1	CMOS battery failure	<ul style="list-style-type: none"> <li>• Reset the main battery connection.</li> <li>• If problem persists, replace the main battery.</li> </ul>
3	2	PCI or Video card/chip failure	Replace the system board.

**Table 21. System-diagnostic lights (continued)**

Blinking pattern		Problem description	Suggested resolution
Amber	White		
3	3	BIOS Recovery image not found	<ul style="list-style-type: none"> <li>Flash latest BIOS version</li> <li>If problem persists, replace the system board.</li> </ul>
3	4	BIOS Recovery image found but invalid	<ul style="list-style-type: none"> <li>Flash latest BIOS version</li> <li>If problem persists, replace the system board.</li> </ul>
3	5	Power rail failure	Replace the system board.
3	6	Flash corruption detected by SBIOS.	<ul style="list-style-type: none"> <li>Press power button for over 25 seconds to do RTC reset. If problem persists, replace the system board.</li> <li>Disconnect all power source (AC, battery, coin cell) and drain flea power by pressing and holding down power button 3~5 seconds to ensure all power are drained.</li> <li>Run "BIOS recovery from USB", and the instructions are in the website <a href="#">Dell support</a>.</li> <li>If problem persists, replace the system board.</li> </ul>
3	7	Timeout waiting on ME to reply to HECI message.	Replace the system board.

**NOTE:** Blinking 3-3-3 LEDs on Lock LED (Caps-Lock or Num-Lock), Power button LED (without Fingerprint reader), and Diagnostic LED indicates failure to provide input during LCD panel test on Dell SupportAssist Pre-boot System Performance. Check diagnostics.

## Recovering the operating system

When your computer is unable to boot to the operating system even after repeated attempts, it automatically starts Dell SupportAssist OS Recovery.

Dell SupportAssist OS Recovery is a standalone tool that is preinstalled in all Dell computers installed with Windows operating system. It consists of tools to diagnose and troubleshoot issues that may occur before your computer boots to the operating system. It enables you to diagnose hardware issues, repair your computer, back up your files, or restore your computer to its factory state.

You can also download it from the Dell Support website to troubleshoot and fix your computer when it fails to boot into their primary operating system due to software or hardware failures.

For more information about the Dell SupportAssist OS Recovery, see *Dell SupportAssist OS Recovery User's Guide* at [www.dell.com/serviceabilitytools](http://www.dell.com/serviceabilitytools). Click **SupportAssist** and then, click **SupportAssist OS Recovery**.

## Real Time Clock—RTC reset

The Real Time Clock (RTC) reset function allows you or the service technician to recover the recently launched model Dell Latitude and Precision systems from **No POST/No Boot/No Power** situations. You can initiate the RTC reset on the system

from a power-off state only if it is connected to AC power. Press and hold the power button for 25 seconds. The system RTC reset occurs after you release the power button.

**NOTE:** If AC power is disconnected from the system during the process or the power button is held longer than 40 seconds, the RTC reset process gets aborted.

The RTC reset will reset the BIOS to Defaults, un-provision Intel vPro and reset the system date and time. The following items are unaffected by the RTC reset:

- Service Tag
- Asset Tag
- Ownership Tag
- Admin Password
- System Password
- HDD Password
- Key Databases
- System Logs

**NOTE:** The IT administrator's vPro account and password on the system will be un-provisioned. The system needs to go through the setup and configuration process again to reconnect it to the vPro server.

The below items may or may not reset based on your custom BIOS setting selections:

- Boot List
- Enable Legacy Option ROMs
- Secure Boot Enable
- Allow BIOS Downgrade

## Backup media and recovery options

It is recommended to create a recovery drive to troubleshoot and fix problems that may occur with Windows. Dell proposes multiple options for recovering Windows operating system on your Dell PC. For more information, see [Dell Windows Backup Media and Recovery Options](#).

## WiFi power cycle

### About this task

If your computer is unable to access the internet due to WiFi connectivity issues a WiFi power cycle procedure may be performed. The following procedure provides the instructions on how to conduct a WiFi power cycle:

**NOTE:** Some ISPs (Internet Service Providers) provide a modem/router combo device.

### Steps

1. Turn off your computer.
2. Turn off the modem.
3. Turn off the wireless router.
4. Wait for 30 seconds.
5. Turn on the wireless router.
6. Turn on the modem.
7. Turn on your computer.





# Getting help and contacting Dell

## Self-help resources

You can get information and help on Dell products and services using these self-help resources:

**Table 22. Self-help resources**

Self-help resources	Resource location
Information about Dell products and services	<a href="http://www.dell.com">www.dell.com</a>
My Dell app	
Tips	
Contact Support	In Windows search, type <code>Contact Support</code> , and press Enter.
Online help for operating system	<a href="http://www.dell.com/support/linux">www.dell.com/support/linux</a> <a href="http://www.dell.com/support/windows">www.dell.com/support/windows</a>
Access top solutions, diagnostics, drivers and downloads, and learn more about your computer through videos, manuals and documents.	Your Dell computer is uniquely identified by a Service Tag or Express Service Code. To view relevant support resources for your Dell computer, enter the Service Tag or Express Service Code at <a href="http://www.dell.com/support">www.dell.com/support</a> .  For more information on how to find the Service Tag for your computer, see <a href="#">Locate the Service Tag on your computer</a> .
Dell knowledge base articles for a variety of computer concerns	<ol style="list-style-type: none"> <li>1. Go to <a href="http://www.dell.com/support">www.dell.com/support</a>.</li> <li>2. On the menu bar at the top of the Support page, select <b>Support &gt; Knowledge Base</b>.</li> <li>3. In the Search field on the Knowledge Base page, type the keyword, topic, or model number, and then click or tap the search icon to view the related articles.</li> </ol>

## Contacting Dell

To contact Dell for sales, technical support, or customer service issues, see [www.dell.com/contactdell](http://www.dell.com/contactdell).

 **NOTE:** Availability varies by country/region and product, and some services may not be available in your country/region.

 **NOTE:** If you do not have an active Internet connection, you can find contact information about your purchase invoice, packing slip, bill, or Dell product catalog.