

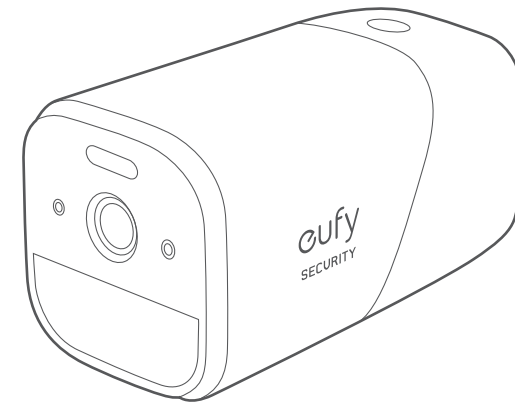

QUICK START GUIDE

eufy SECURITY 4G Starlight Camera



1 / OVERVIEW

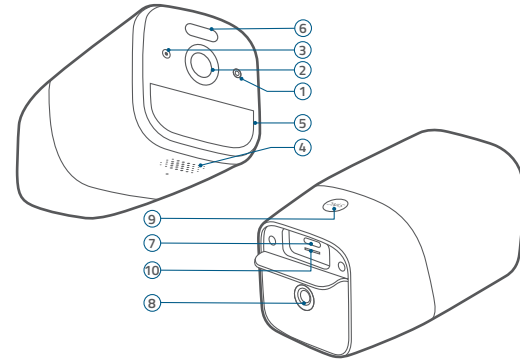

Model: TB150

- 1 LED Indicator
- 2 Camera Lens
- 3 Microphone
- 4 Speaker
- 5 Motion Sensor
- 6 Spotlight
- 7 Charging Port
- 8 Mounting Hole
- 9 SYNC Button
 - Press and hold for 2 seconds to enter setup mode
 - Press and hold for 8 seconds to reset
- 10 Nano SIM Card Tray Slot

2 / CHARGING

LED Indicator	Description
Blue	Charging
OFF	Fully charged

Option 1. Wall Charger

Connect the camera to a wall charger (not provided).

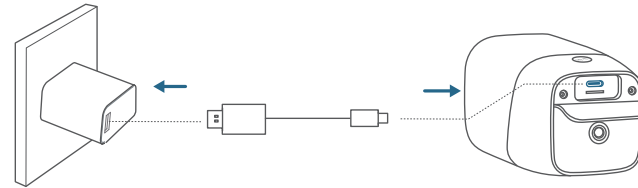

Option 2. eufy Solar Panel Charger

Follow the eufy Solar Panel Charger's user manual to install the solar panel (not provided).

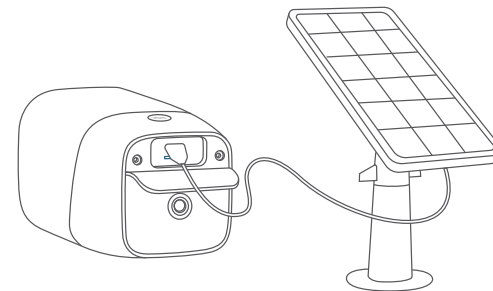

3 / SETTING UP

1. Insert your Nano SIM card into the camera.

💡 4G Band: B2/B4/B5/B12/B13/B14/B66/B71; Compatible With AT&T.

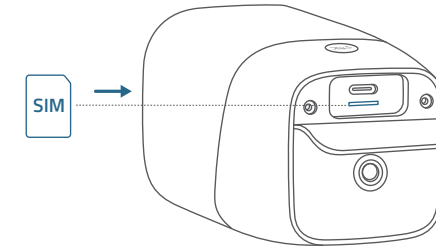

2. Download and install the eufy Security app, then sign up for an account.



3. Follow on-screen instructions to complete the setup.

LED Indicator	Description
Flashing blue	Ready for setup
OFF	Successfully added to the eufy Security app
Red	Live streaming or recording
Flashing red	Alarm triggered
Flashing blue and red	Updating firmware

4 / MOUNTING

Select a location

You can mount the camera in the areas without power supply or Wi-Fi, such as outdoors, holiday homes, small construction sites, small farms, and small warehouses. For best results, hang it 3.5-10 ft (1-3 m) above the ground.

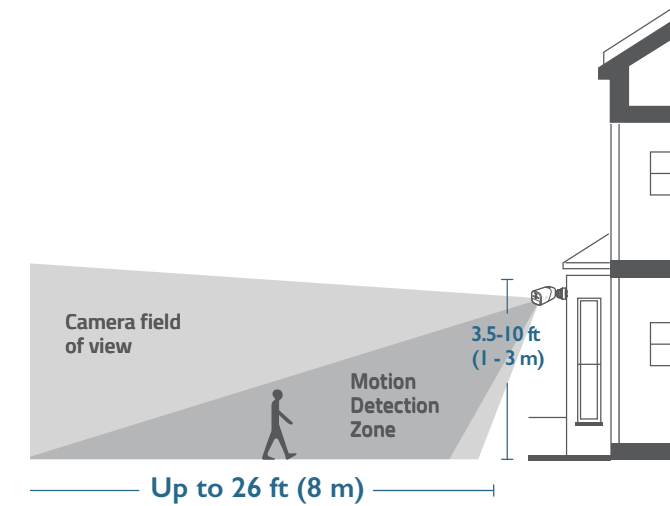

Mount the camera

1. Turn the knob of the mounting bracket counterclockwise to loosen and disassemble it.

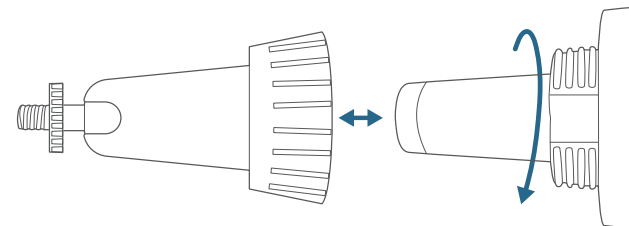

2. Place the mounting bracket against the wall. Drill holes with a 15/64" (6 mm) drill bit, then insert the anchors into the holes; anchors are necessary for walls that are made out of hard materials such as concrete, brick, or stucco.

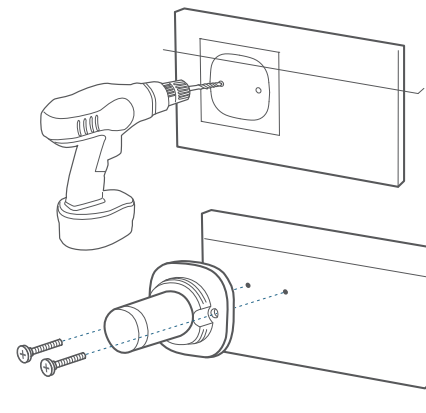

05

3. Firmly screw the knob of the mounting bracket into the mounting hole.

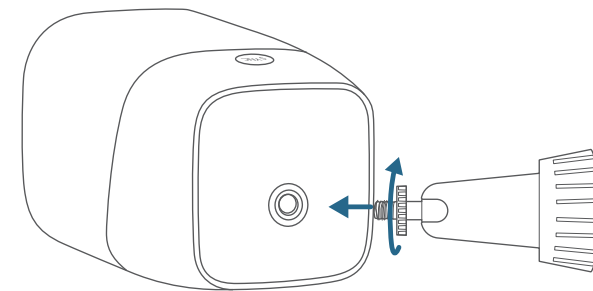

4. Hold and screw the camera to the mounting bracket. Rotate the camera to adjust the view and check it using the live stream, which you can access in the eufy Security app.

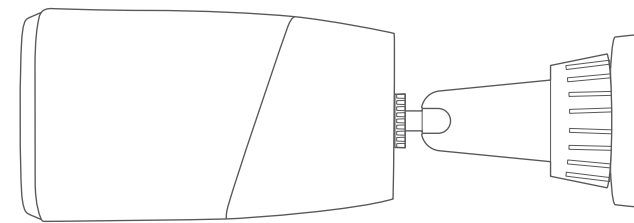

The camera can be also installed on the ceiling. Follow the steps above to install it.

06

5 / NOTICE

FCC Statement

This device complies with Part 15 of the FCC Rules. Operation is subject to the following two conditions: (1) this device may not cause harmful interference, and (2) this device must accept any interference received, including interference that may cause undesired operation.

Warning: Changes or modifications not expressly approved by the party responsible for compliance could void the user's authority to operate the equipment.

Note: This equipment has been tested and found to comply with the limits for a Class B digital device, pursuant to Part 15 of the FCC Rules. These limits are designed to provide reasonable protection against harmful interference in a residential installation.

This equipment generates uses and can radiate radio frequency energy and, if not installed and used in accordance with the instructions, may cause harmful interference to radio communications. However, there is no guarantee that interference will not occur in a particular installation. If this equipment does cause harmful interference to radio or television reception, which can be determined by turning the equipment off and on, the user is encouraged to try to correct the interference by one or more of the following measures: (1) Reorient or relocate the receiving antenna. (2) Increase the separation between the equipment and receiver. (3) Connect the equipment into an outlet on a circuit different from that to which the receiver is connected. (4) Consult the dealer or an experienced radio/TV technician for help.

FCC Radio Frequency Exposure Statement

The device has been evaluated to meet general RF exposure requirements. The device can be used in fixed/mobile exposure condition. The min separation distance is 20cm.

Notice: Shielded cables

All connections to other computing devices must be made using shielded cables to maintain compliance with FCC regulations.
The following importer is the responsible party
Company Name: POWER MOBILE LIFE, LLC
Address: 10900 NE 8th St, Ste 501, Bellevue WA 98004
Telephone: 1-800-988-7973

07

Warning:

- replacement of a battery with an incorrect type that can defeat a safeguard;
- disposal of a battery into fire or a hot oven, or mechanically crushing or cutting of a battery, that can result in an explosion;
- leaving a battery in an extremely high temperature surrounding environment that can result in an explosion or the leakage of flammable liquid or gas; and
- a battery subjected to extremely low air pressure that may result in an explosion or the leakage of flammable liquid or gas.

CAUTION RISK OF EXPLOSION IF BATTERY IS REPLACED BY AN INCORRECT TYPE. DISPOSE OF USED BATTERIES ACCORDING TO THE INSTRUCTIONS

Customer Service

Warranty

12-month limited warranty

Call Us

United States
+1 (800) 988 7973 Mon-Fri 6:15-17:00(PT)
Sat-Sun 6:30-16:30(PT)

United Kingdom

+44 (0) 1604 936 200 Mon-Fri 6:00-17:00
Sat-Sun 6:00-14:00

Germany

+49 (0) 69 9579 7960 Mo-Fr 8:00-16:00

Email Us

support@eufylife.com

Anker Innovations Limited

Room 1318-19, Hollywood Plaza, 610 Nathan Road, Mongkok, Kowloon, Hong Kong

 @EufyOfficial

 @EufyOfficial

 @EufyOfficial

08

09