

# RICOH



Digital Camera

# RICOH WG-80

Start Guide

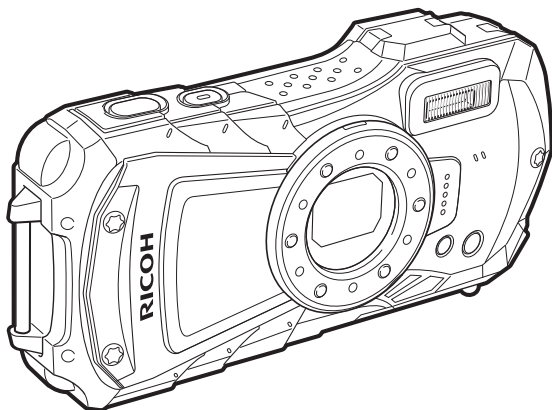

To ensure the best performance from your camera, please read this manual before using the camera.

Model:R06020

Thank you for purchasing this RICOH WG-80 Digital Camera.

This Start Guide provides information on how to get your RICOH WG-70 ready for use and its basic operations. To ensure proper operation, please read this Start Guide before using the camera.

For details on how to use the various shooting methods and settings, please refer to the Operating Manual (PDF) posted on our website.

Refer to p.59 for details on the Operating Manual.

### **Regarding copyrights**

Images taken with this digital camera that are for anything other than personal enjoyment cannot be used without permission according to the rights as specified in the Copyright Act. Please take care, as there are cases where limitations are placed on taking pictures even for personal enjoyment during demonstrations, performances or of items on display. Images taken with the purpose of obtaining copyrights also cannot be used outside the scope of use of the copyright as laid out in the Copyright Act, and care should be taken here also.

### **Regarding trademarks**



- SDXC logo is a trademark of SD-3C, LLC.
- HDMI, the HDMI logo, and High-Definition Multimedia Interface are trademarks or registered trademarks of HDMI Licensing, LLC in the United States and/or other countries.
- This product supports PRINT Image Matching III. PRINT Image Matching enabled digital still cameras, printers and software help photographers to produce images more faithful to their intentions. Some functions are not available on printers that are not PRINT Image Matching III compliant. Copyright 2001 Seiko Epson Corporation. All Rights Reserved. PRINT Image Matching is a trademark of Seiko Epson Corporation. The PRINT Image Matching logo is a trademark of Seiko Epson Corporation.
- This product is licensed under the AVC Patent Portfolio License for the personal use of a consumer or other uses in which it does not receive remuneration to (i) encode video in compliance with the AVC standard ("AVC video") and/or (ii) decode AVC video that was encoded by a consumer engaged in a personal activity and/or was obtained from a video provider licensed to provide AVC video. No license is granted or shall be implied for any other use. Additional information may be obtained from MPEG LA, LLC. See <http://www.mpegla.com>.
- All other trademarks are the property of their respective owners.

## To users of this camera

- Do not use or store this camera in the vicinity of equipment that generates strong electromagnetic radiation or magnetic fields.  
Strong static charges or the magnetic fields produced by equipment such as radio transmitters could interfere with the display, damage the stored data, or affect the camera's internal circuitry and cause camera misoperation.
- The liquid crystal panel used for the display is manufactured using extremely high precision technology. Although the level of functioning pixels is 99.99% or better, you should be aware that 0.01% or fewer of the pixels may not illuminate or may illuminate when they should not. However, this has no effect on the recorded image.
- There is a possibility that the illustrations and the screen display in this manual are different from the actual ones.
- In this manual, SD Memory Cards, SDHC Memory Cards and SDXC Memory Cards are referred to as SD Memory Cards.
- In this manual, the generic term "computer(s)" refers to either a Windows PC or a Macintosh.
- In this manual, the term "battery(ies)" refers to any type of batteries used for this camera and its accessories.

In this manual, the capture mode, such as for taking still pictures and recording movies, is referred to as "📷 mode" (capture mode) ("Still Picture Capture Mode" refers to the mode for taking still pictures and "Movie Mode" refers to the mode for recording movies). The playback mode, such as for viewing captured images on the display, is referred to as "▶ mode" (playback mode). In ▶ mode, you can perform simple editing operations on the images that are played back.

The meanings of the symbols used in this manual are explained below.

	Indicates the reference page number for an explanation of the related operation.
	Indicates information that is useful to know.
	Indicates precautions to be taken when operating the camera.

## Using Your Camera Safely

We have paid close attention to the safety of this camera. When using this camera, we request your special attention regarding items marked with the following symbols.



### Warning

This symbol indicates that ignoring this item could cause serious personal injuries.



### Caution

This symbol indicates that ignoring this item could cause minor or medium personal injuries, or loss of property.

## About the Camera

### Warning

- Do not attempt to take the camera apart or modify the camera. High voltages are present within the camera, and there is a danger of electric shock if the camera is taken apart.
- If the inside of the camera should become exposed as a result of, for example, the camera being dropped, please do not under any circumstances touch such exposed portions, as there is a danger of receiving an electric shock.
- Wrapping the strap around a neck is dangerous. Take care that small children do not hang the strap around their necks.
- If any irregularities occur during use, such as smoke or a strange odor, stop use immediately, remove the battery, and contact your nearest service center. Continued use can cause a fire or electric shock.

### Caution

- Do not place your finger on the flash when it is discharging as there is a risk of burns.
- Do not discharge the flash while it is touching your clothing as there is a risk of discoloring.
- Some portions of the camera heat up during use, so please take care, as there is a risk of low temperature burns if such portions are held for long periods of time.
- Should the display be damaged, be careful of glass fragments. Also, be careful not to allow the liquid crystal to get on your skin, in your eyes, or in your mouth.
- Depending on your individual factors or physical condition, the use of the camera may cause itching, rashes or blisters. In case of any abnormality, stop using the camera and get medical attention immediately.

## About the USB Power Adapter

### Warning

- Always use the USB power adapter exclusively developed for this camera, with the specified power and voltage. Using a USB power adapter not exclusive to this camera, or using the exclusive USB power adapter with an unspecified power or voltage can cause a fire, electric shock, or camera breakdown. The specified voltage is 100-240V AC.
- Do not disassemble or modify the product. This can cause a fire or electric shock.
- If the generation of smoke or strange odor from the product or other abnormality occurs, immediately discontinue its use and consult your nearest service center. Continued use can cause a fire or electric shock.
- If water should happen to get inside the product, consult your nearest service center. Continued use can cause a fire or electric shock.
- If you see a lightning flash or hear thunder during use of the USB power adapter, unplug the AC plug and discontinue use. Continued use can cause damage to the product, fire, or electric shock.
- Wipe off the AC plug if it becomes covered with dust. Accumulated dust may cause a fire.

## Caution

- Do not place or drop heavy objects on or forcefully bend the USB cable. Doing so may damage the cable. Should the cable be damaged, consult your nearest service center.
- Do not touch or short-circuit the terminal area of the USB cable while the cable is plugged in.
- Do not handle the AC plug with wet hands. This can cause an electric shock.
- Do not subject the product to strong impacts or allow it to drop onto a hard surface. This can cause a malfunction.
- Do not use the power adapter to charge a battery other than a rechargeable lithium-ion battery D-LI92. This can cause overheating, explosion, or connected device failure.
- To reduce the risk of hazards, use only a CSA/UL certified power supply cord set, cord is Type SPT-2 or heavier, minimum NO.18 AWG copper, one end with a molded-on male attachment plug cap (with a specified NEMA configuration), and the other is provided with a molded-on female connector body (with a specified IEC nonindustrial type configuration) or the equivalent.

## About the Battery

### Warning

- Be sure to store the battery out of the reach of small children. Placing it in their mouths may cause an electric shock.
- If any leakage from the battery should come in contact with your eyes, it may cause a loss of sight. Flush your eyes with clean water and get medical attention immediately. Do not rub them.

### Caution

- Only use the specified battery with this camera. Use of other batteries may cause an explosion or fire.
- Do not disassemble the battery. Disassembling the battery may cause an explosion or leakage.
- Remove the battery from the camera immediately if it becomes hot or begins to smoke. Be careful not to burn yourself during removal.
- Keep wires, hairpins, and other metal objects away from the + and - contacts of the battery.
- Do not short the battery or dispose of the battery in fire. This can cause an explosion or fire.
- If any leakage from the battery should come in contact with skin or clothes, it may cause irritation to the skin. Wash the affected areas thoroughly with water.
- Precautions for D-LI92 Battery Usage:
  - BATTERY MAY EXPLODE OR FIRE IF MISTREATED.
  - DO NOT DISASSEMBLE OR DISPOSE OF IN FIRE.
  - DO NOT CHARGE EXCEPT SPECIFIED CHARGING CONDITION.
  - DO NOT HEAT ABOVE 140°F / 60°C, OR SHORT CIRCUIT.
  - DO NOT CRUSH OR MODIFY.

## Keep the Camera and its Accessories out of the Reach of Small Children

### Warning

- Be sure to keep the camera and its accessories out of the reach of small children.
  1. Injuries may result from the product falling or from unexpected movement.
  2. Suffocation may result from wrapping the strap around the neck.
  3. Small accessories such as battery or an SD Memory Card may be swallowed. Seek medical attention immediately if an accessory is accidentally swallowed.

# Care to be Taken During Handling

## Before Using Your Camera

- When the camera has not been used for a long time, confirm that it is still working properly, particularly prior to taking important pictures (such as at a wedding or when traveling). Contents of the recording cannot be guaranteed if recording, playback or transferring your data to a computer, etc. is not possible due to a malfunction of your camera or recording media (SD Memory Card), etc.
- The lens on this camera is not interchangeable. The lens is not removable.

## About the Battery and USB Power Adapter

- To keep the battery in optimum condition, avoid storing it in a fully charged state or in high temperatures.
- If the battery is left inserted and the camera is not used for a long time, the battery will over-discharge and shorten the battery's life.
- Charging the battery a day before use or on the day of use is recommended.
-  Class II equipment: The provided USB power adapter is a Class II (double-insulated) product.

## Precautions on Carrying and Using Your Camera

- Hot and humid places should be avoided. Particular care should be taken regarding vehicles, which can become very hot inside.
- Ensure that the camera is not subjected to substantial vibrations, shocks, or pressure as this may cause damage, malfunction, or a loss in waterproof performance. Place the camera on a cushion for protection when the camera is subjected to the vibrations of a motorbike, car, ship, etc. If the camera is subjected to substantial vibrations, shocks, or pressure, take your camera to your nearest service center and have it checked.
- The temperature range in which the camera can be used is -10°C to 40°C (14°F to 104°F).
- The display will become black at high temperatures but will return to normal at normal temperatures.
- The response speed of the display becomes slow at low temperatures. This is due to the properties of the liquid crystal and is not a malfunction.
- If the camera is subjected to rapid temperature changes, condensation may form on the inside and outside of the camera. Therefore put the camera in a bag or plastic bag and take it out when the difference in temperature has subsided.
- Avoid contact with garbage, mud, sand, dust, water, toxic gases, or salt. These could cause the camera to breakdown. Wipe the camera to dry off any rain or water drops.
- Do not press the display with excessive force. This could cause it to break or malfunction.
- Be careful not to sit down with the camera in your back pocket as this may damage the exterior of the camera or the display.
- When using a tripod with the camera, be careful not to overtighten the screw in the tripod socket on the camera.



## Cleaning Your Camera

- Do not clean the camera with organic solvents such as thinner, alcohol or benzine.
- Use a lens brush to remove dust accumulated on the lens. Never use a spray blower for cleaning as it may damage the lens.

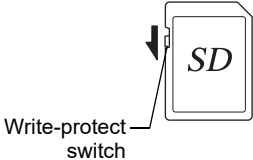
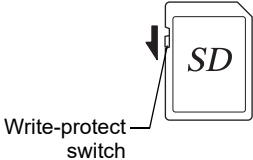
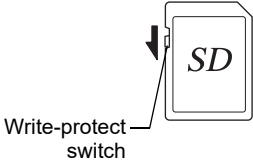
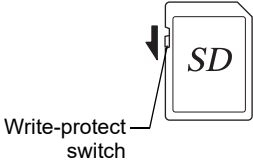

## Storing Your Camera

- Avoid storing the camera where pesticides and chemicals are handled. Remove the camera from its case and store it in a well-ventilated place to prevent the camera from becoming moldy during storage.
- Avoid using or storing the camera where it may be exposed to static electricity or electrical interference.
- Avoid using or storing the camera in direct sunlight or in locations where it may be exposed to rapid changes in temperature or to condensation.
- Periodic inspections are recommended every one to two years to maintain high performance.

## Other Precautions

- The SD Memory Card is equipped with a write-protect switch. Setting the switch to LOCK prevents new data from being recorded on the card, the stored data from being deleted, and the card from being formatted by the camera or computer.    
   
Write-protect switch
-  appears on the display when the card is write-protected.
- Care should be taken when removing the SD Memory Card immediately after using the camera, as the card may be hot.
- Keep the battery/card cover closed and do not remove the SD Memory Card or turn the camera off while the data is being played back or saved to the card, or the camera is connected to a computer with the USB cable, as this may cause the data to be lost or the card to be damaged.
- Do not bend the SD Memory Card or subject it to violent impact. Keep it away from water and store away from high temperature.
- Do not remove the SD Memory Card during formatting as this may damage the card and render it unusable.
- The data on the SD Memory Card may be lost in the following circumstances. We do not accept any liability for data that is deleted
  - (1) when the SD Memory Card is mishandled by the user.
  - (2) when the SD Memory Card is exposed to static electricity or electrical interference.
  - (3) when the SD Memory Card has not been used for a long time.
  - (4) when the SD Memory Card is ejected or the batteries are removed while the card is being accessed.
- If it is not used for a long time, the data on the card may become unreadable. Be sure to regularly make a backup of important data on a computer.
- Be sure to format SD Memory Cards that are unused or have been used on another camera.
- When using an SD Memory Card with a slow recording speed, recording may stop while recording a movie even if there is adequate space in the memory, or image capture or playback may take a long time.
- Please note that deleting data, or formatting the SD Memory Cards or the built-in memory does not completely erase the original data. Deleted files can sometimes be recovered using commercially available software. It is user's responsibility to ensure the privacy of such data.

# Contents

Using Your Camera Safely.....	1
Care to be Taken During Handling.....	4
Contents.....	6
<b>Checking the Contents of the Package .....</b>	<b>7</b>
<b>Names of Parts.....</b>	<b>8</b>
<b>Names of Operating Parts.....</b>	<b>9</b>
<b>Display Indications .....</b>	<b>12</b>
Display in  Mode .....	12
Display in  Mode .....	13
Guide Display.....	14
<b>Powering the Camera .....</b>	<b>15</b>
Installing the Battery .....	15
Charging the Battery .....	17
<b>Installing an SD Memory Card.....</b>	<b>19</b>
<b>Turning the Camera On and Off.....</b>	<b>21</b>
Starting-up in Playback Mode .....	21
<b>Initial Settings .....</b>	<b>22</b>
Setting the Display Language .....	22
Setting the Date and Time .....	23
<b>Setting the Camera Functions.....</b>	<b>24</b>
Operating the Menus .....	24
Menu List .....	26
Resetting to Default Settings (Reset).....	29
Displaying the Clock Display.....	29
<b>Taking Still Pictures.....</b>	<b>30</b>
Taking Pictures .....	30
Using the Zoom.....	32
Setting the Shooting Mode.....	33
Using the Self-timer.....	36
<b>Setting the Shooting Functions.....</b>	<b>38</b>
Using the Rec. Mode Menu Items.....	38
Selecting the Flash Mode .....	39
Selecting the Focus Mode .....	40
<b>Recording Movies.....</b>	<b>43</b>
Recording Movies .....	43
Recording a Movie Quickly Using the Movie Button .....	44
<b>Playing Back Images.....</b>	<b>45</b>
Playing Back Still Pictures.....	45
Playing Back a Movie.....	45
Using the Playback Functions.....	46
<b>Deleting Images .....</b>	<b>49</b>
Deleting a Single Image.....	49
<b>Appendix.....</b>	<b>50</b>
Main Specifications .....	50
Warranty Policy.....	54
Information on the Operating Manual.....	59
Regarding User Registration.....	59



# Checking the Contents of the Package

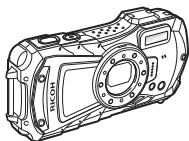

Camera  
RICOH WG-80

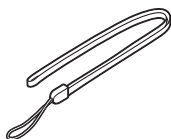

Strap  
O-ST104 (\*)

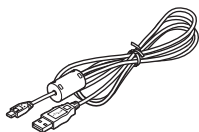

USB cable  
I-USB157 (\*)  
or I-USB170(\*)



Rechargeable lithium-ion  
battery D-LI92 (\*)



USB power  
adapter



Power  
plug



Macro stand  
O-MS1

Start Guide (this manual)  
Regarding Waterproof,  
Dustproof, and Shockproof  
Design

\* Available as optional accessories.

# Names of Parts

## Front

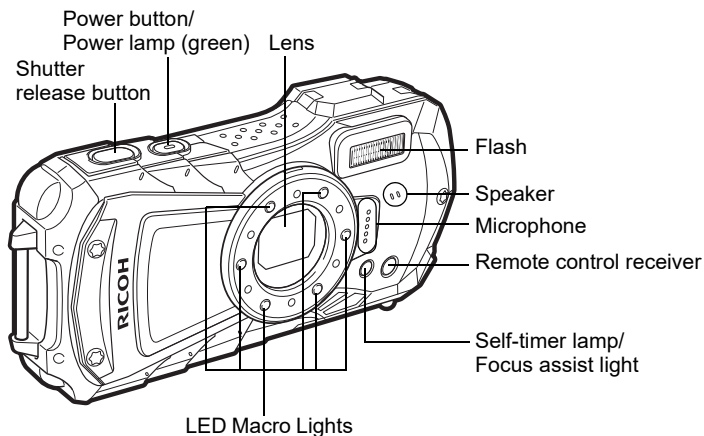

## Back

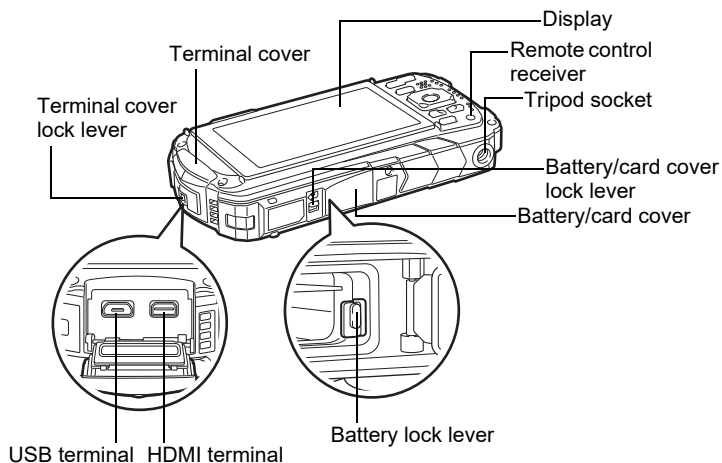

# Names of Operating Parts

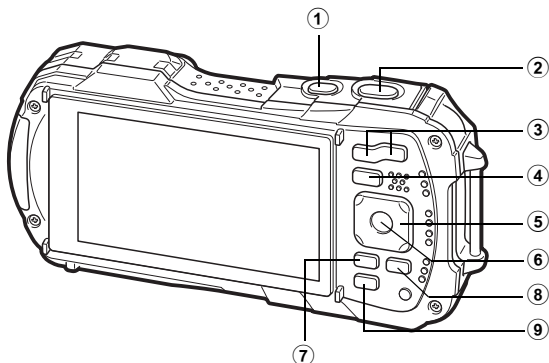

## ① Power button

Turns the camera on and off (p.21).

## ② Shutter release button

📷 Mode:

Focuses the camera on the subject when pressed halfway in Still Picture Capture Mode (except when the focus mode is set to **PF**, **▲**, and **MF**) (p.30). Takes a still picture when pressed down fully (p.31).

Pressing down fully starts and stops movie recording in **MOVIE** (Movie), **UW** (Underwater Movie), and **HS** (High Speed Movie) modes (p.43).

▶ Mode:

Switches to 📷 mode.

## ③ W/T button

📷 Mode:

Changes the captured area (p.32).

▶ Mode:

In single-image display, pressing **6** switches to 6-image display. Pressing **12** again switches to 12-image display. Press **Q** to return to the previous display. In single-image display, pressing **Q** magnifies the image. Press **6** to return to the previous display.

In 12-image display, press **6** to change to folder or calendar display.

In folder/calendar display, press **Q** to change to 12-image display.

Adjusts the volume during playback of movies (p.45).

④

**▶ button****📷** Mode:

Switches to ▶ mode.

▶ Mode:

Switches to 📷 mode.

⑤

**Four-way controller****📷** Mode:

(▲) : Changes the drive mode (p.36).

(▼) : Displays the Capture Mode Palette (p.34).

(◀) : Changes the flash mode (p.39).

(▶) : Changes the focus mode (p.40).

(▲▼) : Adjusts the focus when the focus mode is set to **MF** (p.41).

▶ Mode:

(▲) : Plays back and pauses a movie (p.45).

(▼) : Displays the Playback Mode Palette (p.48).  
Stops a movie during playback (p.45).

(◀▶) : Displays the previous or next image during single-image display (p.45).

Fast-forwards, fast-reverses, frame forwards, and frame reverses during movie playback (p.45).

(▲▼◀▶) : Changes the position of the area to be magnified during zoom display.

Selects an image in 6- or 12-image display, a folder in folder display, and a date in calendar display.

Adjusts the position of a frame or an image when you are using the Original Frame function.

⑥

**OK button****📷** Mode:

Changes the information on the display (p.12).

▶ Mode:

Changes the information on the display (p.13).

Returns zoom, 6- or 12-image display to single-image display.

Changes to 12-image display of the selected folder during folder display.

Changes to single-image display of the selected date during calendar display.

⑦

**MENU button****📷** Mode:In Still Picture Capture Mode, [**📷** Rec. Mode] menu appears. In Movie Mode, [**🎬** Movie] menu appears (p.24).

▶ Mode:

Displays the [**⚙** Setting] menu during single-image display (p.24).

Returns to single-image display during Playback Mode Palette display (p.47).

Returns zoom, 6- or 12-image display to single-image display.

Switches from folder/calendar display to 12-image display with the cursor placed on the most recent image.

## 8 **Movie button**

 Mode:

Starts movie recording in Still Picture Capture Mode (p.44).

## 9 **Green/ button**

 Mode:

Switches to  (Green) mode.

Calls up the assigned function.

 Mode:

Switches from single-image display to the Delete screen (p.49).

Switches from 6- or 12-image display to the Select & Delete screen.

Switches from folder display to the calendar display screen.

Switches from calendar display to the folder display screen.

In this manual, the method for operating the four-way controller is shown in illustrations, such as in the ones below.

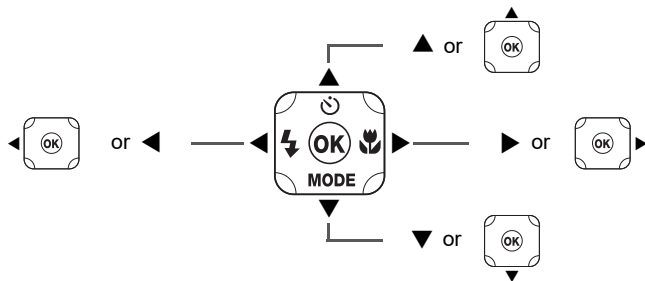

## Macro stand

Attaching the supplied macro stand (O-MS1) reduces camera shake during shooting in  (Digital Microscope) mode. Insert two clips into the slits in upper and lower sides of the LED Macro Lights part. When attaching and detaching the macro stand, do not hold the clip part.

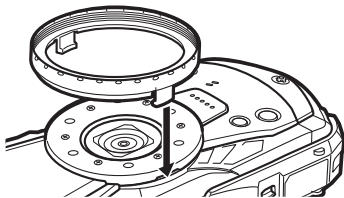

\* When using the macro stand, the camera may not be able to focus if the objects have uneven surfaces.

# Display Indications



## Display in Mode

The display changes in the following sequence each time you press the **OK** button: “Normal Display”, “Histogram + Info”, “Grid Display”, “No Info”, “LCD Off”.

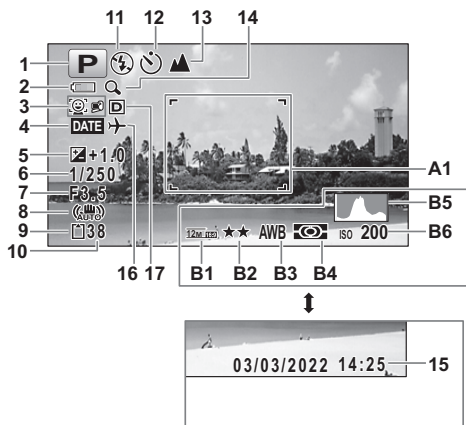
**Normal Display/ Histogram + Info/ Grid Display in Still Picture Capture Mode**  
1 to 17 and A1 appear when “Normal Display” is selected. B1 to B6 appear at the position of 15 when “Histogram + Info” is selected. Only A1 appears when “Grid Display” or “No Info” is selected.



- |  |   |
|--|---|
| <b>1</b> Shooting mode (p.33)              | <b>14</b> Digital zoom/Intelligent Zoom icon (p.32) |
| <b>2</b> Battery level indicator (p.18)    | <b>15</b> Date and time (p.23)                      |
| <b>3</b> Face Detection icon               | <b>16</b> World Time setting                        |
| <b>4</b> Date Imprint setting              | <b>17</b> D-Range Setting                           |
| <b>5</b> EV Compensation                   | <b>A1</b> Focus frame (p.30)                        |
| <b>6</b> Shutter speed                     | <b>B1</b> Recorded Pixels                           |
| <b>7</b> Aperture                          | <b>B2</b> Quality Level                             |
| <b>8</b> Pixel Track SR icon               | <b>B3</b> White Balance                             |
| <b>9</b> Memory status (p.21)              | <b>B4</b> AE Metering                               |
| <b>10</b> Remaining image storage capacity | <b>B5</b> Histogram                                 |
| <b>11</b> Flash Mode (p.39)                | <b>B6</b> Sensitivity                               |
| <b>12</b> Drive Mode (p.36)                |   |
| <b>13</b> Focus Mode (p.40)                |   |

- \* 6 and 7 are only displayed when the shutter release button is pressed half-way.
- \* For 8,  is displayed when Pixel Track SR is set to  (On) on the [Rec. Mode] menu.  is displayed when the shutter release button is pressed halfway if Pixel Track SR is set to  (Off) and there is a danger of camera shake.
- \* For 13, when the focus mode is set to **AF** and the Auto Macro function is activated,  appears on the display (p.40).
- \* 15 appears for two seconds after the camera is turned on.
- \* 17 changes depending on [D-Range Setting] settings in the [Rec. Mode] menu. No icon is displayed on the screen when [Highlight Correction] and [Shadow Correction] are both set to [Off].
- \* When the shooting mode is **AUTO PICTURE** (Auto Picture) and if you press the shutter release button halfway, the automatically selected shooting mode appears in A1 even when "No Info" is selected.
- \* If there are overexposed highlight areas in the image, they will blink red on the display, and if there are underexposed shadow areas, they will blink yellow.
- \* Some indications may not appear depending on the shooting mode.

## Display in Mode



The display shows the shooting information of the image in playback mode. The display changes in the following sequence each time you press the **OK** button:

### Normal Display/Histogram + Info in Playback Mode

**(All of the display items are displayed here for explanatory purposes.)**

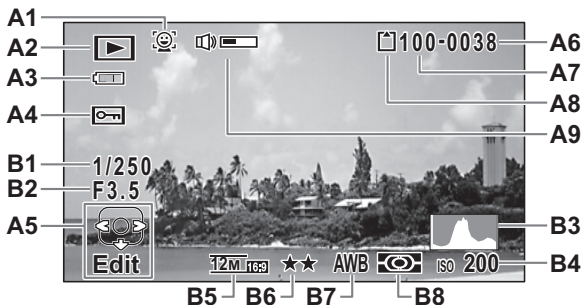
The display shows information such as the shooting conditions. In "Normal Display", A1 to A9 are displayed. In "Histogram + Info", B1 to B8 are displayed as well.















- |   |                           |
|---|---------------------------|
| <b>A1</b> Face Detection icon   | <b>A9</b> Volume icon     |
| <b>A2</b> Playback mode<br> : Still picture (p.45)<br> : Movie (p.45) | <b>B1</b> Shutter speed   |
| <b>A3</b> Battery level indicator (p.18)  | <b>B2</b> Aperture        |
| <b>A4</b> Protect icon  | <b>B3</b> Histogram       |
| <b>A5</b> Four-way controller guide   | <b>B4</b> Sensitivity     |
| <b>A6</b> File number   | <b>B5</b> Recorded Pixels |
| <b>A7</b> Folder number   | <b>B6</b> Quality Level   |
| <b>A8</b> Memory status (p.21)  | <b>B7</b> White Balance   |
|   | <b>B8</b> AE Metering     |

- \* A1 appears only if the Face Detection function worked when the image was shot.
- \* In “Normal Display”, A3 disappears if no operation is performed for two seconds.
- \* A5 appears even when “No Info” is selected, but disappears if no operation is performed for two seconds. When no operation is performed for two seconds in “Normal Display” or “Histogram + Info”, only “Edit” disappears.
- \* A9 appears only when the volume is being adjusted during playback of movies (p.45).
- \* When “Normal Display” is selected, the shooting date and time appears for two seconds in the B4 to B8 positions.
- \* If there are overexposed highlight areas in the image, they will blink red on the display, and if there are underexposed shadow areas, they will blink yellow.

## Guide Display

A guide indicator for each available button or key operation appears as follows on the display during operation.

	Four-way controller (▲)
	Four-way controller (▼)
	Four-way controller (◀)
	Four-way controller (▶)
	<b>MENU</b> button

	Zoom button
	<b>OK</b> button
	Shutter release button
 (green), 	Green/  button
 (red)	Movie button



# Powering the Camera

## Installing the Battery

Use the rechargeable lithium-ion battery D-LI92 that is provided with the camera.

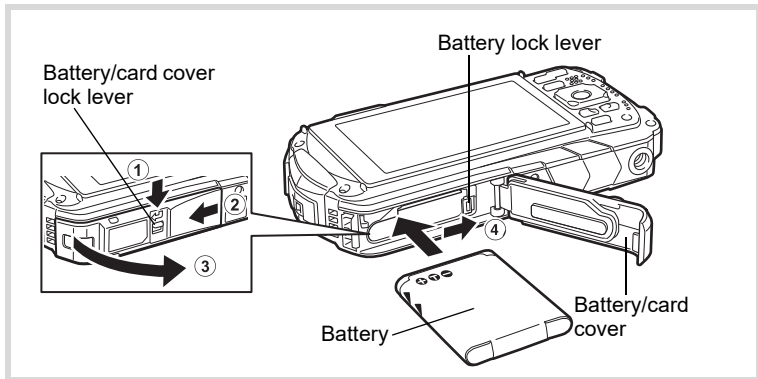

**1**

### Open the battery/card cover.

Press the battery/card cover lock lever in the direction shown ①, slide the cover towards ② and open it towards ③.

**2**

### Using the side of the battery to press the battery lock lever in the direction of ④, insert the battery with the PENTAX logo pointing toward the lens.

Push the battery in until it is locked in place.



If the battery is incorrectly oriented, malfunction may result.

**3**

### Close the battery/card cover.

Push down and slide the battery/card cover with steady but gentle force in the opposite direction indicated by ②.

The battery/card cover may be difficult to close because the waterproof packing is very thick to prevent water from entering the camera.

To close the battery/card cover, push down on it toward the camera with your thumb where it says [PUSH]. Then slide it until the battery/card cover lock lever slides into place covering the yellow mark on the lock lever.

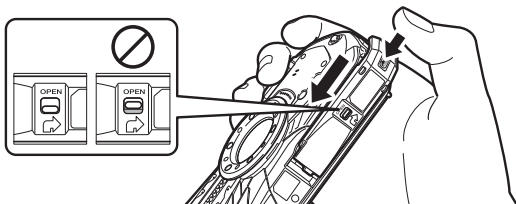

## Removing the Battery

- 1** Open the battery/card cover.
- 2** Push the battery lock lever towards ④.

The battery will be ejected. Take care not to drop the battery when removing it.



- Do not use excessive force when opening and closing the battery/card cover because the waterproof seal may peel off. If the seal is not in the correct position, the camera will not be waterproof.
- If the battery/card cover is not locked securely, water, sand, or dirt may get into the camera.
- This camera uses a rechargeable lithium-ion battery D-LI92. Use of any other type of battery may damage the camera and cause malfunction.
- Insert the battery correctly. If the battery is incorrectly oriented, malfunction may result.
- Do not remove the battery while the camera is turned on.
- When storing the battery for more than 6 months, charge the battery for 30 minutes using the USB power adapter and store the battery separately. Be sure to recharge the battery every 6 to 12 months. Storing the battery below room temperature is ideal. Avoid storing it in high temperatures.
- The date and time may be returned to the default settings if the camera is left without the battery for a long time.
- Be careful as the camera or the battery may become hot when the camera is used continuously for a long period of time.
- Allow the camera to dry completely before changing the battery. Avoid changing the battery where the camera is likely to get wet or dirty, and make sure that your hands are dry.

### For Customers in USA and Canada Lithium-Ion batteries are recyclable.

You can help preserve our environment by returning your used rechargeable batteries to the collection and recycling location nearest you.

For more information regarding recycling of rechargeable batteries, call toll free 1-800-822-8837, or visit <http://www.call2recycle.org/>

## Charging the Battery

Connect the supplied USB power adapter to the camera and charge the battery before using it for the first time or after a long period of non-use, or when the [Battery depleted] message appears.

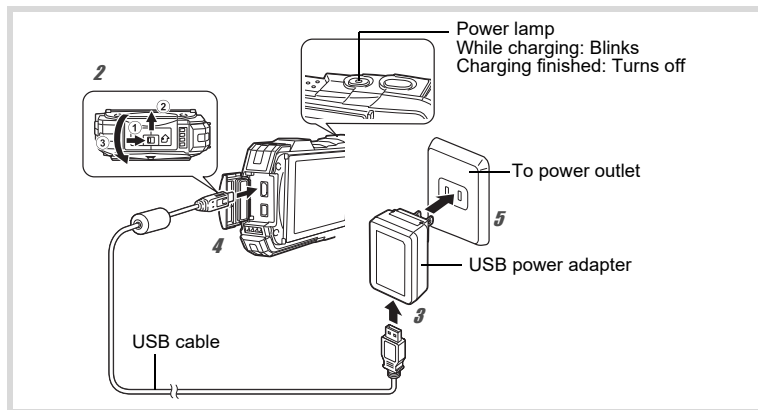

### 1 Insert the power plug to the USB power adapter.

Insert it until it clicks into place.

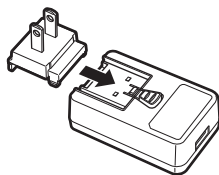

### 2 Make sure that the camera is turned off and open the terminal cover.

Move the terminal cover lock lever in the direction shown by ①, slide the cover in the direction shown by ② and open the cover in the direction shown by ③.

### 3 Connect the USB cable to the USB power adapter.

### 4 Connect the USB cable to the camera.

### 5 Plug the USB power adapter into the power outlet.

The power lamp blinks while charging.

When charging is finished, the power lamp turns off.

The terminal cover will not close while charging. Leave the cover open when charging and do not attempt to close it.

**6** Unplug the USB power adapter from the power outlet when charging is finished.

**7** Remove the USB cable from the camera.

**8** Close the terminal cover.

Close the terminal cover in the opposite direction indicated by ③. While lightly pressing on the cover, slide it away from ② until it clicks.



- Do not use the supplied USB power adapter for any other purpose than that of connecting to this camera and charging the designated battery. Doing otherwise may cause a connected device to be damaged or overheated.
- The battery has reached the end of its service life when it starts to run down soon after being charged. Replace it with a new battery.
- If the camera is connected to the power outlet but the charging indicator fails to light, the battery may be faulty. Replace it with a new battery.



- The time required to fully charge the battery is about 120 minutes (max.). (The charging time may vary depending on the ambient temperature and charging conditions.) The appropriate ambient temperature for charging the battery is 0°C to 40°C (32°F to 104°F).
- You cannot turn on the camera while it is charging.

• **Image Storage Capacity, Movie Recording Time, and Playback Time (at 23°C (73.4°F) with the display on and the battery fully charged)**

Image Storage Capacity <sup>*1</sup> (flash used for 50% of shots)	Movie Recording Time <sup>*2</sup>	Playback Time <sup>*2</sup>
Approx. 300 pictures	Approx. 90 min.	Approx. 260 min.

\*1 The image storage capacity shows the approximate number of shots recorded during CIPA-compliant testing (at 23°C (73.4°F) with display on and flash used for 50% of the shots). Actual performance may vary according to operating conditions.

\*2 According to the results of in-house testing.



- Battery performance may deteriorate as temperature decreases. When using the camera in cold regions, we recommend carrying a spare battery in your pocket to keep it warm. Battery performance will recover when the temperature returns to normal.
- Be sure to take a spare battery with you when traveling abroad or to a cold region, or if you intend to take a lot of pictures.

• **Battery Level Indicator**

You can check the battery level by the indicator on the display.

Screen Display	Battery Status
(green)	Adequate power remains.
(green)	Battery is running low.
(yellow)	Battery is running very low.
(red)	Battery is exhausted.
[Battery depleted]	The camera will turn off after this message appears.

# Installing an SD Memory Card

This camera uses SD Memory Cards, SDHC Memory Cards or SDXC Memory Cards. Captured images are saved on the SD Memory Card if a card is inserted in the camera. They are saved in the built-in memory if a card is not inserted (p.21).



- Be sure to use this camera to format (initialize) an SD Memory Card that is unused or has been previously used on other cameras or digital devices.
- Make sure that the camera is turned off before inserting or removing the SD Memory Card.
- Allow the camera to dry completely before changing the SD Memory Card. Avoid changing the card where the camera is likely to get wet or dirty, and make sure that your hands are dry.
- Do not use excessive force when sliding the battery/card cover open and closed because the waterproof seal may peel off. If the seal is not in the correct position, the camera will not be waterproof.



- The number of still pictures that can be stored varies depending on the capacity of the SD Memory Card and the selected number of recorded pixels and quality level (p.51).
- The power lamp blinks while the SD Memory Card is being accessed (data is being recorded or read).

## Backing Up Data

The camera may not be able to access data in the built-in memory in the case of a malfunction. Use a computer or other device to back up important data in another location.

## Displaying data stored in the built-in memory

When an SD Memory Card is inserted in the camera, still pictures and movies on the SD Memory Card are displayed. If you want to display still pictures and movies stored in the built-in memory, turn the camera off and remove the SD Memory Card.



Make sure that the camera is turned off before inserting or removing the SD Memory Card.

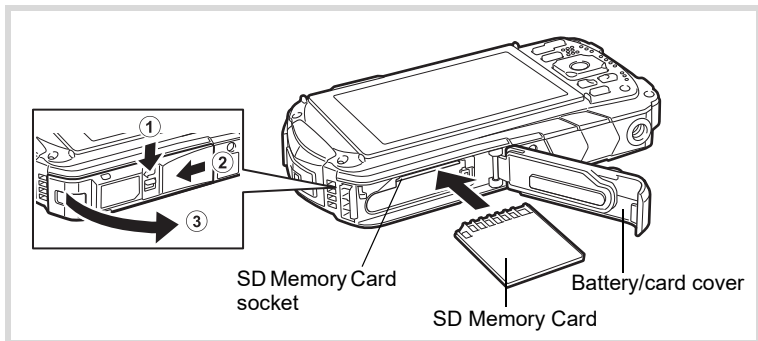

## 1 Open the battery/card cover.

Press the battery/card cover lock lever in the direction shown ①, slide the cover towards ② and open it towards ③.

## 2 Insert the SD Memory Card into the SD Memory Card socket so that the label is facing toward the front of the camera (the side with the lens).

Push the card in all the way. Images may not be recorded correctly if the card is not inserted all the way.

To remove the SD Memory Card, push it in once and then pull it out.

## 3 Close the battery/card cover.

Push down and slide the battery/card cover with steady but gentle force in the opposite direction indicated by ②.



If the battery/card cover is not locked securely when you close it, water, sand, or dirt may get into the camera.



- The image file size varies depending on the number of recorded pixels and the number of images that can be saved on an SD Memory Card also varies.
- Set the number of recorded pixels for still pictures from the [📷 Rec. Mode] menu and for movies from the [🎬 Movie] menu.
- For an approximate number of still pictures and amount of time of movies that can be saved on an SD Memory Card, see "Main Specifications" (p.50).

# Turning the Camera On and Off

## 1 Press the power button.

The camera turns on and both the power lamp and display turn on. If the [Language/言語] screen or [Date Adjustment] screen appears when you turn the camera on, follow the procedure on p.22 to set the display language and/or current date and time.

## 2 Press the power button again.

The camera turns off and both the power lamp and display turn off.

Taking Still Pictures p.30

## Checking the SD Memory Card

The SD Memory Card is checked when the camera turns on and the memory status is displayed.

	The SD Memory Card is inserted. Images will be saved on the SD Memory Card.
	The SD Memory Card is not inserted. Images will be saved in the built-in memory.
	The write-protect switch on the SD Memory Card is in the LOCK position (p.5). Images cannot be recorded.



Memory status

## Starting-up in Playback Mode

Use this function when you want to play back images straightaway without taking any picture.

## 1 Press and hold down the button.

The display turns on and the camera starts up in playback mode.



- To switch from playback mode to capture mode, press the button or press the shutter release button halfway.
- In order to set the camera not to start up in playback mode, set [Playback Mode] to (Off) from [Startup Shortcut] in the [Setting] menu.

Playing Back Still Pictures p.45

# Initial Settings

The [Language/言語] screen appears when the camera is turned on for the first time. Perform the operations in “Setting the Display Language” below to set the language, and in “Setting the Date and Time” (p.23) to set the current date and time.

## Setting the Display Language

**1** Use the four-way controller (▲▼◀▶) to choose the display language.

**2** Press the OK button.

The [Initial Setting] screen appears in the selected language. If the desired settings for [Hometown] and [DST] (Daylight Saving Time) appear, proceed to step 9.

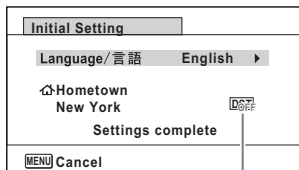

Daylight saving time

**3** Press the four-way controller (▼).  
The frame moves to [Hometown].

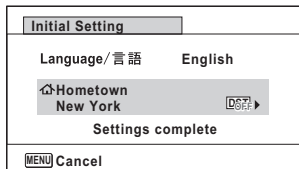

**4** Press the four-way controller (▶).  
The [Hometown] screen appears.

**5** Use the four-way controller (◀▶) to choose a city.

**6** Press the four-way controller (▼).

The frame moves to [DST] (Daylight Saving Time).

**7** Use the four-way controller (◀▶) to select  (On) or  (Off).

**8** Press the OK button.

The [Initial Setting] screen reappears.

**9** Press the four-way controller (▼) to select [Settings complete].

**10** Press the OK button.

The [Date Adjustment] screen appears. Next, set the date and time.



## Setting the Date and Time

Set the current date and time and the display format.

**1 Press the four-way controller (▶).**

The frame moves to [mm/dd/yy].

**2 Use the four-way controller (▲▼) to choose the date and time display format.**

Choose from [mm/dd/yy], [dd/mm/yy] or [yy/mm/dd].

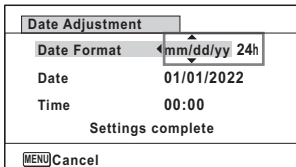

**3 Press the four-way controller (▶).**

The frame moves to [24h].

**4 Use the four-way controller (▲▼) to select [24h] (24-hour display) or [12h] (12-hour display).**

**5 Press the four-way controller (▶).**

The frame returns to [Date Format].

**6 Press the four-way controller (▼).**

The frame moves to [Date].

**7 Press the four-way controller (▶).**

The frame moves to the month.

**8 Use the four-way controller (▲▼) to change the month.**

Change the day and year in the same manner.

Next, change the time.

**9 Press the four-way controller (▼) to select [Settings complete].**

**10 Press the OK button.**

This confirms the date and time.



If you press the **OK** button in step 10, the camera clock is reset to 0 seconds. To set the exact time, press the **OK** button when the time signal (on the TV, radio, etc.) reaches 0 seconds.



When the [Initial Setting] or [Date Adjustment] screen is displayed, you can cancel the setting operation and switch to capture mode by pressing the **MENU** button. In this case, the [Initial Setting] screen will appear next time you turn the camera on.

# Setting the Camera Functions

To change the camera settings, press the **MENU** button to display the [📷 Rec. Mode] menu or [⚙️ Setting] menu. Functions for playing back and editing images can be accessed from the Playback Mode Palette.

## Operating the Menus

There are three types of menus: [📷 Rec. Mode], [🎥 Movie] and [⚙️ Setting]. Press the **MENU** button in Still Picture Capture Mode to display the [📷 Rec. Mode] menu. Press the **MENU** button in Movie Mode to display the [🎥 Movie] menu. Press the **MENU** button in [▶️] mode to display the [⚙️ Setting] menu. Use the four-way controller (◀️▶️) to move between menus.

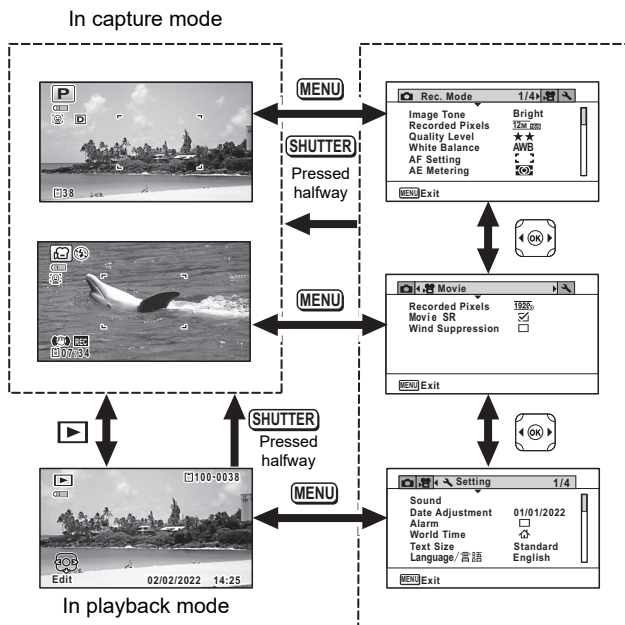



- Available button and key operations appear on the display during menu operation.
- The **MENU** button function varies depending on the screen. Refer to the guide indications.







<b>MENU</b>	Exit	Exits the menu and returns to the original screen.
<b>MENU</b>		Returns to the previous screen with the current settings.
<b>MENU</b>	Cancel	Cancels the current selection, exits the menu and returns to the previous screen.



## Menu List

The following list shows the items that can be set with the menus and provides descriptions of each item.

### [📷 Rec. Mode] Menu

This menu provides the functions related to taking still pictures and recording movies.

Item		Description	Default Setting (Shooting mode: <b>P</b> )
Image Tone		For setting the tone of images	Bright
Recorded Pixels		For choosing the number of recorded pixels of still pictures	 (4608 x 2592)
Quality Level		For setting the quality level of still pictures	★★ (Better)
White Balance		For adjusting the color balance according to the lighting conditions	<b>AWB</b> (Auto)
AF Setting	Focusing Area	When <b>AF</b> (Standard),  (Macro), or  (1cm Macro) is selected as the focus mode, you can change the autofocus area (Focusing Area)	 (Multiple)
	Auto Macro	For choosing whether or not to use the auto macro function	<input checked="" type="checkbox"/> (On)
	Focus Assist	For setting whether or not to use the focus assist light	<input checked="" type="checkbox"/> (On)
AE Metering		For choosing the area of the screen that is metered to determine the exposure	 (Multi-segment)
Sensitivity		For setting the sensitivity	AUTO (125-1600)
AUTO ISO Range		For setting the adjustment range when the sensitivity is set to AUTO	125-1600
EV Compensation		For adjusting the overall brightness of an image	±0.0
D-Range Setting	Highlight Correction	For setting the bright portion correction function	Auto
	Shadow Correction	For setting the dark portion correction function	Auto
Pixel Track SR		For choosing whether to compensate for camera shake while taking still pictures	<input type="checkbox"/> (Off)
Face Detection		For automatically setting the focus and exposure according to faces that are detected and for setting the Self-portrait Assist function	 (Face Detection On)
Blink Detection		For choosing whether to use the Blink Detection function with the Face Detection function	<input checked="" type="checkbox"/> (On)

Item	Description	Default Setting (Shooting mode: <b>P</b> )
Digital Zoom	For choosing whether or not to use the digital zoom	<input checked="" type="checkbox"/> (On)
Instant Review	For choosing whether to display Instant Review	<input checked="" type="checkbox"/> (On)
Memory	For choosing whether to save the set values of the shooting functions or return to the defaults when the camera is turned off	—
Green Button	For assigning a function to the Green button in <b>☘</b> mode	Green mode
Sharpness	For choosing sharp or soft outlines	 (Normal)
Saturation (Tone Adjustment)	For setting the color saturation. When [Monochrome] is selected, the item changes to [Tone Adjustment]	 Normal (B&W for Tone Adjustment)
Contrast	For setting the image contrast level	 (Normal)
Date Imprint	For choosing whether to imprint the date and/or time when taking still pictures	Off
IQ Enhancer*	For setting whether to apply the IQ Enhancer process to an image	<input checked="" type="checkbox"/> (On)
Macro Light	Set On, Off, or Brightness adjustment for the LED for macro photography.	<input checked="" type="checkbox"/> (On)

\*IQ Enhancer = Image Quality Enhancer





- Use the **☘** (Green) mode to enjoy easy picture-taking with standard settings, regardless of the settings made from the [Rec. Mode] menu.
- Assigning a frequently used function to the Green button enables you to go straight to the desired function.

## [🎬 Movie] Menu

Item	Description	Default Setting
Recorded Pixels	For choosing the number of recorded pixels and the frame rate for movies	 (1920 x 1080-30fps)
Movie SR	For choosing whether or not to use the Movie Shake Reduction function	<input checked="" type="checkbox"/> (On)
Wind Suppression	For suppressing wind noises while recording movies	<input type="checkbox"/> (Off)

## [⚙️ Setting] Menu

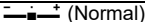
Item	Description	Default Setting
Sound	For adjusting the operation volume and playback volume, and setting the start-up sound, shutter sound, key operation sound, and self-timer sound	—
Date Adjustment	For adjusting the date and time	—

Item	Description	Default Setting	
Alarm	For setting the alarm	—	
World Time	For setting the Hometown and Destination cities	—	
Text Size	For setting the text size of the menu	Standard	
Language/言語	For setting the language in which menus and messages appear	According to initial setting	
Folder Name	For choosing how names are assigned to folders for storing images	Date	
File Name	For choosing how names are assigned to images	RIMG	
USB Connection	For setting the method for connecting the camera to a PC by the USB cable (MSC or PTP)	MSC	
HDMI Out	For setting the HDMI output format when connecting to an AV device with an HDMI terminal	Auto	
Brightness Level	For adjusting the brightness of the display	 (Normal)	
Outdoor View Stg.	For adjusting the brightness of the display for outdoor shooting.	 (Off)	
Power Saving	For setting the time until the camera enters power-saving mode	5 sec.	
Auto Power Off	For setting the time until the camera turns off automatically	3 min.	
Quick Zoom	For choosing whether to use the Quick Zoom function when playing back images	<input type="checkbox"/> (Off)	
Guide Display	For setting whether to display explanations for selected items in Capture Mode Palette and Playback Mode Palette	<input checked="" type="checkbox"/> (On)	
Reset	For returning settings other than the date and time, language and world time to their defaults	Cancel	
Delete All	For deleting all the images at once	Cancel	
Pixel Mapping	For correcting defective pixels on the image sensor	Cancel	
Startup Shortcut	Playback Mode	For setting whether to start-up the camera in playback mode.	<input checked="" type="checkbox"/> (On)
	LED Lighting	For setting whether to turn the LED Macro Lights on with the camera turned off.	<input checked="" type="checkbox"/> (On)
	Clock Display	For setting whether to display the clock with the camera turned off.	<input checked="" type="checkbox"/> (On)
Format	For formatting the SD Memory Card/built-in memory	Cancel	

## Resetting to Default Settings (Reset)

You can reset the camera settings to their defaults.

- 1 Use the four-way controller (▲▼) to select [Reset] in the [↶ Setting] menu.**
- 2 Press the four-way controller (▶).**  
The [Reset] screen appears.
- 3 Use the four-way controller (▲) to select [Reset].**

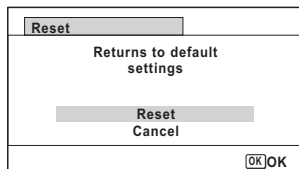

- 4 Press the OK button.**  
The settings return to the defaults.

## Displaying the Clock Display

You can use the camera as a clock. With the camera turned off, press and hold down the **OK** button to display the clock on the display.

- 1 Press and hold down the OK button.**  
The camera turns on and the clock appears on the screen.  
The camera turns off automatically after approximately 10 seconds.  
Pressing the power button turns the camera off immediately.



Not to function the Clock Display by pressing **OK** button, set [Clock Display] to  (Off) in [Startup Shortcut] from the [↶ Setting] menu.

# Taking Still Pictures

## Taking Pictures

This camera has various functions and shooting modes that support a wide array of scenes and subjects. This section explains shooting with the default settings when shipped.

### 1 Press the power button.

The camera turns on and is ready to take still pictures. In this manual, this is called Still Picture Capture Mode.

### 2 Check the subject and shooting information on the display.

The focus frame in the middle of the display indicates the automatic focusing area.



Focus frame

When the camera detects a person's face, the Face Detection function is activated and the face detection frame appears.

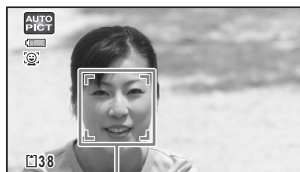

Face detection frame

You can change the captured area by pressing the zoom button (p.32).

Right (**T**)      Enlarges the subject.

Left (**W**)      Widens the area that is captured by the camera.

### 3 Press the shutter release button halfway.

The camera emits focus assist light in dark shooting situations.

The focus frame (or face detection frame) on the display turns green when the camera focuses on the subject.





## 4

### Press the shutter release button fully.

The picture is taken.

The flash discharges automatically depending on the light conditions.

The image appears on the display temporarily (Instant Review) and is saved to the SD Memory Card or the built-in memory.



is displayed when the shutter release button is pressed halfway if there is a risk of camera shake.

### Using the Shutter Release Button

The shutter release button works in a two-step action as follows.

#### Press halfway

This refers to pressing the shutter release button gently to the first position. This locks the focus setting and exposure. The green focus frame lights on the display when the shutter release button is pressed halfway and the subject is in focus. If the subject is out of focus, the frame turns white.

#### Press fully

This refers to pressing the shutter release button all the way down to the fully depressed position. This takes a picture.

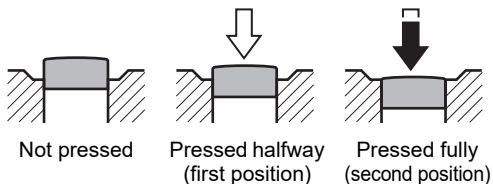

#### Poor focusing conditions

The camera may not be able to focus under the following conditions. In these cases, lock the focus on an object the same distance away as the subject (by pressing and holding the shutter release button halfway), then aim the camera at your subject and press the shutter release button fully.

- Objects that lack contrast such as a blue sky or white wall
- Dark places or objects, or conditions that prevent light being reflected back
- Intricate patterns
- Fast moving objects
- When both an object in the foreground and an object in the background exist in the captured area
- Strongly reflected light or strong backlighting (bright background)

# Using the Zoom

You can use the zoom to change the captured area.

## 1 Press the W/T button in mode.

**W** Wide (left)

Widens the area that is captured by the camera.

**T** Tele (right)

Enlarges the subject.

If you continue to press **T**, the camera automatically switches from optical zoom to Intelligent Zoom and stops at the point where the zoom switches to digital zoom.

Once the button is released and pressed again, the camera switches to digital zoom.

If the digital zoom is set to off in the menu, the optical zoom and the Intelligent Zoom ranges are available for use. The zoom ratio of the Intelligent Zoom varies depending on the number of recorded pixels.



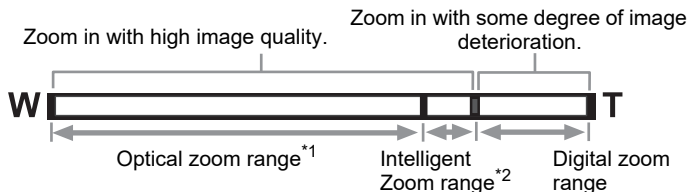





The zoom bar is displayed as follows.



\*1 You can zoom in to a maximum of 5x optically.

\*2 The Intelligent Zoom range varies depending on the number of recorded pixels. See the following table.

## Recorded pixels and the maximum zoom ratio

Recorded Pixels	Intelligent Zoom (The zoom ratio includes the 5x optical zoom.)	Digital zoom
 /  / 	Not Available (5x optical zoom only)	Equivalent to approx. 36x
 / 	Approx. 7.5x	
 / 	Approx. 8.9x	
 (*1)	Approx. 11.3x	
	Approx. 12x	

Recorded Pixels	Intelligent Zoom (The zoom ratio includes the 5x optical zoom.)	Digital zoom
2M (*2)	Not Available (5x optical zoom only)	
1280 (*2)	Not Available (5x optical zoom only)	
1024	Approx. 22.5x	Equivalent to approx. 36x
640	Approx. 36x (same as digital zoom)	

(\*1) Intelligent Zoom and digital zoom are not available when  (Report) mode is set. (Only 5x optical zoom is available.)

(\*2) indicates values that can only be set when  (Report) mode is set.



- We recommend you use a tripod to prevent camera shake when taking pictures at high zoom ratios.
- Pictures taken in the digital zoom range appear grainier than pictures taken in the optical zoom range.
- The image magnified using Intelligent Zoom may appear rough on the display. This does not affect the quality of the recorded image.
- Intelligent Zoom is available regardless of whether the digital zoom is turned on or off.

## Setting the Shooting Mode

This camera has a variety of shooting modes that let you take pictures or record movies in different situations simply by choosing the right mode for the particular situation from the Capture Mode Palette.

### 1 Press the four-way controller (▼) in mode.

The Capture Mode Palette appears.

### 2 Use the four-way controller (▲▼◀▶) to choose a shooting mode.























































The guide of the selected shooting mode is displayed in the lower part of the display.

















### 3 Press the OK button.

The shooting mode is selected and the camera returns to capture mode.

The following modes can be selected from the Capture Mode Palette.

Item	Description	Page															
 Auto Picture	<p>The camera automatically selects the appropriate shooting mode from the following fifteen modes</p> <table border="1" data-bbox="357 239 850 676"> <tr> <td data-bbox="357 239 523 337">  Standard           </td> <td data-bbox="523 239 688 337">  Night Scene           </td> <td data-bbox="688 239 850 337">  Night Scene Portrait           </td> </tr> <tr> <td data-bbox="357 337 523 407">  Landscape           </td> <td data-bbox="523 337 688 407">  Flower           </td> <td data-bbox="688 337 850 407">  Portrait           </td> </tr> <tr> <td data-bbox="357 407 523 477">  Sport           </td> <td data-bbox="523 407 688 477">  Candlelight           </td> <td data-bbox="688 407 850 477">  Blue Sky           </td> </tr> <tr> <td data-bbox="357 477 523 575">  Portraitx Blue Sky           </td> <td data-bbox="523 477 688 575">  Portraitx Backlight           </td> <td data-bbox="688 477 850 575">  Sunset           </td> </tr> <tr> <td data-bbox="357 575 523 673">  Portraitx Sunset           </td> <td data-bbox="523 575 688 673">  Group Photograph           </td> <td data-bbox="688 575 850 673">  Text           </td> </tr> </table> <p>* When the camera detects the pet's face, the shutter is automatically released.</p>	 Standard	 Night Scene	 Night Scene Portrait	 Landscape	 Flower	 Portrait	 Sport	 Candlelight	 Blue Sky	 Portraitx Blue Sky	 Portraitx Backlight	 Sunset	 Portraitx Sunset	 Group Photograph	 Text	—
 Standard	 Night Scene	 Night Scene Portrait															
 Landscape	 Flower	 Portrait															
 Sport	 Candlelight	 Blue Sky															
 Portraitx Blue Sky	 Portraitx Backlight	 Sunset															
 Portraitx Sunset	 Group Photograph	 Text															
 Program	<p>Used for basic shooting. The shutter speed and aperture are set automatically by the camera during shooting. However, you can select and set other functions as desired, such as the flash mode and the number of recorded pixels</p>	—															
 HDR	<p>HDR</p> <p>Combines 3 images into a single image delivering a wider dynamic range image</p>	—															
 Handheld Night Snap	<p>Minimizes camera shake for shooting at night or other low light settings</p>	—															
 Movie	<p>For recording movies. Sound is recorded at the same time</p>	p.43															
 High Speed Movie	<p>Captures frames for slow motion playback</p>	—															
 Digital Microscope	<p>Captures the bigger images of the closer objects</p>	—															
 Landscape	<p>For capturing landscape views. Enhances colors of sky and foliage</p>	—															
 Flower	<p>For images of flowers. The outline of the flower is softened</p>	—															
 Portrait	<p>For capturing portraits. Reproduces a healthy and bright skin tone</p>	—															

Item		Description	Page
	Underwater	For capturing images underwater	—
	Underwater Movie	Use this mode for taking underwater movies	—
	Interval Shot	Shoots a series of images at a specified interval of time	—
	Interval Movie	Shoots a series of images at a specified interval, and saves them as a movie	—
	Surf & Snow	For bright images such as sand or snow. Accurately meters for bright scenes	—
	Kids	For capturing moving kids. Reproduces a healthy and bright skin tone	—
	Pet	For capturing images of moving pets	—
	Sport	For a fast moving subject. Tracks the subject until the picture is taken	—
	Night Scene	For night time images. Use of a tripod or other support is suggested	—
	Night Scene Portrait	For images of people at night. Use of a tripod or other support is advised	—
	Fireworks	For capturing fireworks. Use of a tripod or other support is suggested	—
	Food	For images of food and prepared dishes. Enhances saturation and contrast	—
	Digital SR	Higher sensitivity reduces blur	—
	Report	For capturing images with an image size suitable for reports	—

\*  (Green) mode is available in addition to the ones noted above.



- In shooting modes other than (Program), (Night Scene), (Movie), (Digital Microscope), (Handheld Night Snap), (Interval Shot), (Interval Movie), (High Speed Movie), and (Digital SR), Saturation, Contrast, Sharpness, White Balance, etc. are automatically set to the optimal settings for the selected mode.
- In (Digital Microscope) mode, Recorded Pixels can be selected from 12M(16:9), 5M(16:9), 4M(16:9) or 2M(16:9). The maximum magnification varies depending on the Recorded Pixels.
- Some functions may not be available or may not function fully depending on the selected shooting mode.
- The shutter speed tends to be slower when taking pictures of dark scenes. To prevent camera shake, set the Pixel Track SR to (On), or put the camera on a tripod and use the self-timer (p.36) or a remote control unit.

## Using the Self-timer

In Self-timer mode, a picture is taken ten seconds or two seconds after the shutter release button is pressed.

Stabilize the camera with a tripod or other support when taking a picture with the self-timer.

	Use this mode when you want to be included in a group picture. The picture is taken approximately ten seconds after the shutter release button is pressed.
	Use this mode to avoid camera shake. The picture is taken approximately two seconds after the shutter release button is pressed.

### 1 Press the four-way controller () in mode.

The [Drive Mode] screen appears.

### 2 Use the four-way controller ( ) to select and press the four-way controller ().

### 3 Use the four-way controller ( ) to select or and press the OK button.

The camera is ready to take a picture using the self-timer.

When the camera detects a person's face, the Face Detection function is activated and the face detection frame appears.



## 4

### Press the shutter release button to take a picture.

The countdown starts and the remaining seconds are displayed on the screen.

#### If you select

The self-timer lamp and all of the LED Macro Lights turn on.

From 5 seconds before shooting, the LED Macro Lights turn off in order from the top right.

From 3 seconds before shooting, the self-timer lamp blinks.

#### If you select











The self-timer lamp and the LED Macro Lights blink.

The picture is taken after a countdown of either ten seconds or two seconds.



Focusing may be compromised if you move the camera while the self-timer lamp is blinking when taking still pictures.



- In  (Movie),  (Underwater Movie), and  (High Speed Movie) modes, recording will start after ten seconds or two seconds.
- Press the shutter release button halfway while the self-timer is engaged to stop the countdown and press fully to restart the countdown.
-  cannot be selected while the  (Green) mode settings remain at default. Select  in another shooting mode and then switch the shooting mode to .
- The self-timer lamp and LED Macro Lights do not turn on or blink in  (Pet) mode.
- In the following situations, the LED Macro Lights remain turned on regardless of the countdown.
  - In  (Digital Microscope) mode
  - When [Macro Light] in the [📷 Rec. Mode] menu is set to  (On)
- / cannot be selected in some shooting modes.

# Setting the Shooting Functions

## Using the Rec. Mode Menu Items

Settings for shooting are mostly set from the [📷 Rec. Mode] menu. Refer to explanations for each function on how to make these settings.

- 1 Press the MENU button in Still Picture Capture Mode.**  
The [📷 Rec. Mode] menu appears.  
Pressing the MENU button in Movie Mode displays the [🎥 Movie] menu.
- 2 Use the four-way controller (▲ ▼ ◀ ▶) to select an item and set it up.**

## To Save the Setting and Start Taking Pictures

- 3 After setting, press the MENU button.**  
The camera returns to capture mode.  
The setting is saved and the camera returns to the previous screen.



When the [⚙ Setting] menu is displayed from [▶] mode, you can switch to 📷 mode by pressing the ▶ button.

## To Save the Setting and Start Playback of Images

- 3 Press the ▶ button.**  
When the [📷 Rec. Mode], [🎥 Movie] or [⚙ Setting] menu is displayed from 📷 mode, the setting is saved and the camera returns to playback mode.

## To Cancel the Changes and Continue with Menu Operations

- 3 Press the MENU button.**  
The changes are canceled and you can select a menu.





- Some functions may not be available or may not function fully depending on the selected shooting mode.
- The **MENU** button function varies depending on the screen. Refer to the guide indications.

Exit	Exits the menu and returns to the original screen.
↶	Returns to the previous screen with the current settings.
Cancel	Cancels the current selection, exits the menu and returns to the previous screen.

## Selecting the Flash Mode

	Auto	The flash discharges automatically depending on the light conditions.
	Flash Off	The flash does not discharge, regardless of the brightness. Use this mode to take pictures where flash photography is prohibited.
	Flash On	The flash discharges for each shot regardless of the brightness.
	Auto + Red-eye	This mode reduces the red-eye phenomenon caused by the light from the flash being reflected in the subject's eyes. The flash discharges automatically.
	Flash On + Red-eye	This mode reduces the red-eye phenomenon caused by the light from the flash being reflected in the subject's eyes. The flash discharges regardless of the light conditions.
	Macro Light	Light is emitted from the LED surrounding the lens.







- The available modes differ depending on the selected shooting mode, focus mode or drive mode.
- If you use the Face Detection function when is selected, the flash mode is automatically set to .
- A pre-flash discharges when using the red-eye reduction function.





Using the flash when capturing images at a close distance may cause irregularities in the image due to the light distribution.

## 1 Press the four-way controller (◀) in mode.

The [Flash Mode] screen appears. The flash mode changes each time the button is pressed. You can also change the setting using the four-way controller (▲▼).

In  (Underwater) mode,  (Flash Off + Flash On (2 shots)) appears instead of  (Auto + Red-eye) and  (Flash On + Red-eye) as shown on the right.

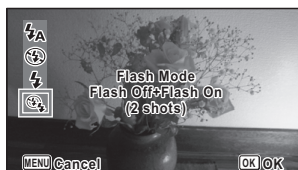

When you select  (Flash Off + Flash On (2 shots)), two images are taken in succession in  (Flash Off) and  (Flash On). After taking the pictures, you can select the best shot from them.





## 2 Press the OK button.

The setting is saved and the camera returns to capture mode.

### About the red-eye phenomenon

Taking pictures using the flash may cause the subject's eyes to appear red in the resulting picture. This phenomenon occurs when the light from the flash is reflected in the subject's eyes. It can be reduced by increasing the illumination in the area around the subject and/or decreasing the subject distance and adjusting the lens to wider angle setting. Setting the flash mode to  (Auto + Red-eye) or  (Flash On + Red-eye) is also an effective way of reducing red eyes.

## Selecting the Focus Mode

 AF	Standard	This mode is used when the distance to the subject is from 50 cm to $\infty$ . The camera is focused on the subject in the autofocus area when the shutter release button is pressed halfway.
	Macro	This mode is used when the distance to the subject is from 10 cm to 60 cm. The camera is focused on the subject in the autofocus area when the shutter release button is pressed halfway.
	1cm Macro	This mode is used when the distance to the subject is from 1 cm to 30 cm. The camera is focused on the subject in the autofocus area when the shutter release button is pressed halfway.

<b>PF</b>	Pan Focus	This mode is used when you ask someone to take pictures for you, or when taking pictures of the scenery through the window of a car or train. The entire picture, from the front to the back, is focused.
<b>▲</b>	Infinity	This mode is used for taking distant objects. The flash is set to  (Flash Off).
<b>MF</b>	Manual Focus	This mode lets you adjust the focus manually.

## 1 Press the four-way controller (▶) in mode.



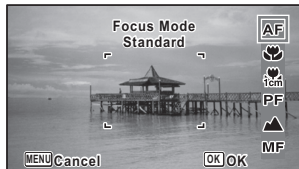

The [Focus Mode] screen appears.  
The focus mode changes each time the button is pressed. You can also change the setting using the four-way controller (▲▼).



## 2 Press the OK button.

The setting is saved and the camera returns to capture mode.



- The available modes differ depending on the selected shooting mode.
- The noise from focusing is recorded when a focus mode other than **PF** or **▲** is selected in  (Movie),  (Underwater Movie), and  (High Speed Movie) modes.
- When [Auto Macro] is on and shooting with  selected, if the subject is further than 60 cm away, the camera automatically focuses to ∞ (Infinity).

## To Set the Manual Focus

The procedure for setting the focus manually (**MF**) is described here.

### 1 Press the four-way controller (▶) in mode.

The [Focus Mode] screen appears.

### 2 Use the four-way controller (▶) to select **MF**.

### 3 Press the OK button.

The central portion of the image is magnified to full screen on the display.

## 4 Press the four-way controller (▲▼).

The **MF** indicator appears on the display to indicate the approximate distance to the subject. Use the four-way controller (▲▼) to adjust the focus using the indicator as a guide.

- ▲ for distant focus
- ▼ for closer focus



**MF** indicator

## 5 Press the OK button.

The focus is locked and the camera returns to capture mode.

After the focus is locked, you can press the four-way controller (▶) again to display the **MF** indicator and readjust the focus.



The shooting mode and drive mode cannot be changed while the **MF** indicator is displayed.



To switch from **MF** to another focus mode, press the four-way controller (▶) while the **MF** indicator is displayed.

# Recording Movies

## Recording Movies

This mode enables you to record movies. Sound is recorded at the same time.

**1** Use the four-way controller (▲▼◀▶) to select  (Movie) from the Capture Mode Palette.

**2** Press the OK button.

The  (Movie) mode is selected and the camera returns to capture mode.

The following information appears on the display.

- 1 Movie mode icon
- 2 Movie Shake Reduction icon
- 3 Remaining recordable time
- 4 REC indicator (blinks during recording)
- 5 Focus frame (does not appear during recording)

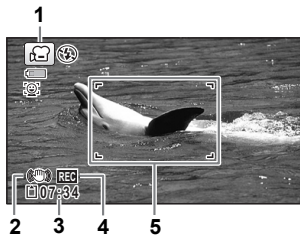

You can change the captured area by pressing the **W/T** button.

**T** Enlarges the subject.

**W** Widens the area that is captured by the camera.

**3** Press the shutter release button fully.

Recording starts. You can continue recording until the recorded movie time reaches 25 minutes.

**4** Press the shutter release button fully.

Recording stops.

Playing Back a Movie  p.45



- The focus mode can be changed before recording starts.
- When the focus mode is set to **MF** (Manual Focus), you can adjust the focus before recording starts and during recording.
- When the shooting mode is set to (Movie), Face Detection is automatically set to on. You can select Smile Capture or Face Detection Off before starting recording a movie. When the Smile Capture function is activated, movie recording starts automatically when the camera recognizes the subject's smile. However, the Smile Capture function may not work depending on the condition of the recognized faces, and movie recording may not start automatically. If this happens, press the shutter release button to start movie recording.
- When you use the SD Memory Card, use SD Speed Class 4 or higher cards.
- Movies recorded in mode capture a different area than still pictures.

## Keeping the Shutter Release Button Pressed

If you keep the shutter release button pressed for more than one second, recording will continue as long as you keep the button pressed. Shooting stops when you take your finger off the shutter release button.

## Recording a Movie Quickly Using the Movie Button

This camera starts/stops movie recording simply by pressing the Movie button, without selecting (Movie) from the Capture Mode Palette. This is useful when you want to start recording quickly.

**1**

### Press the Movie button.

Recording starts. You can continue recording until the recorded movie time reaches 25 minutes.

**2**

### Press the Movie button again.

Recording stops.





- You cannot stop recording by pressing the shutter release button. To stop recording, press the Movie button.
- You cannot start recording a movie by pressing the Movie button when the shooting mode is set to (Movie), (Underwater Movie), (Digital Microscope), (Interval Shot), (High Speed Movie), (Interval Movie), or (Pet), or the camera is in mode.
- Movies are recorded with the default settings for the [ Movie] menu when recording movies with the Movie button (p.27).

# Playing Back Images



## Playing Back Still Pictures

- 1 Press the  button after taking a picture.

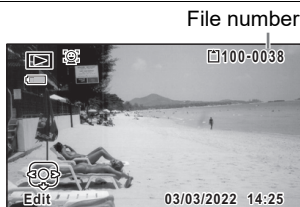
The camera enters  mode and the image appears on the display. Displaying one image in full in  mode (default setting) is called single-image display.





## To Play Back the Previous or Next Image

- 2 Press the four-way controller ( ).

The previous or next image appears.



## To Delete the Displayed Image

Press the  button while the image is displayed to display the Delete screen. Press the four-way controller () to select [Delete] and press the **OK** button.



## Playing Back a Movie

You can play back the movies you have taken. The sound is played back at the same time.

- 1 Enter  mode and use the four-way controller ( ) to choose the movie you want to play back.

- 2 Press the four-way controller ()

Playback starts.



The following operations can be performed during playback.

- |  |                        |
|--|------------------------|
| Four-way controller (▲)                    | Pauses playback        |
| Zoom button right (Q)                      | Increases the volume   |
| Zoom button left (W)                       | Reduces the volume     |
| Press and hold the four-way controller (▶) | Fast-forwards playback |
| Press and hold the four-way controller (◀) | Fast-reverses playback |

The following operations can be performed while playback is paused.

- |                         |                    |
|-------------------------|--------------------|
| Four-way controller (◀) | Reverses frames(*) |
| Four-way controller (▶) | Forwards frames    |
| Four-way controller (▲) | Resumes playback   |

(\*)In frame-reverse mode, the first frame of every 30 frames appears on the display with each press of the four-way controller(◀). For example, when you reverse frames from the second frame to the 31st frame, the first frame appears on the display, and when you reverse frames from the 32nd to 61st, the 31st frame appears.

### 3 Press the four-way controller (▼).

Playback stops.



Only movies taken with this camera can be played back. Movies taken with other cameras cannot be played back.

## Using the Playback Functions

### 1 In mode, press the four-way controller (▼).

The Playback Mode Palette appears.

### 2 Use the four-way controller (▲▼◀▶) to choose an icon.

The guide for the selected function appears below.

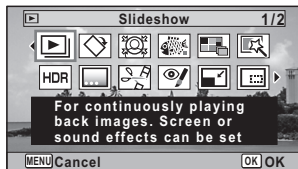

### 3 Press the OK button.

The playback function is recalled.





MENU

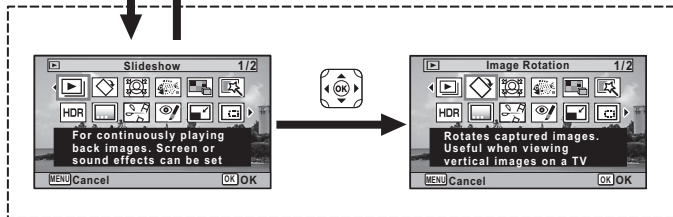

Press **SHUTTER** halfway  
or

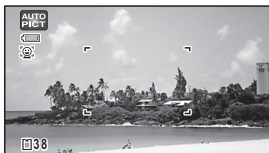

Closes the Playback Mode Palette and goes to mode

**OK**

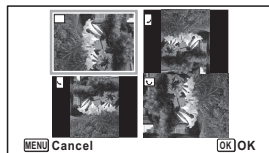















Goes to the screen for selected playback function



When the frame is placed over an icon on the Playback Mode Palette, the guide of that function appears.

## Playback Mode Palette

Playback Mode		Description	Default Setting
	Slideshow	For continuously playing back images. Screen or sound effects can be set	—
	Image Rotation	Rotates captured images. Useful when viewing vertical images on a TV	Normal
	Small Face Filter	Reduces the size of faces in the image, for well-proportioned portraits	Approx. 7%
	Ink Rubbing Filter	Creates an image similar to ink rubbing from original pictures	— + (Standard)
	Collage	Creates a collage print page from saved image files	—
	Digital Filter	For modifying images with a Color filter or Soft filter	B&W/Sepia
<b>HDR</b>	HDR Filter	Processes single image to simulate HDR effect	—
	Original Frame	Available to make from the kind and color of a frame. Available to enter text	All sides/White
	Movie Edit	Save as Still Image	For saving one frame from a movie as a still picture
		Divide Movies	For dividing a movie into two
		Adding title picture	For adding a title picture to your movie
	Red-eye Edit	Attempts to edit out the red-eye effect in image. Success may vary	—
	Resize	Changes Recorded Pixels and Quality Level to make the file size smaller	Depending on the picture taken
	Cropping	For cropping images to the size you like. Saved as a new image	Depending on the picture taken
	Image Copy	To copy images between the built-in memory and an SD Memory Card	Built-in memory → SD Memory Card
	Protect	Protects images from delete function. Format function still erases all	Depending on the picture taken
	Start-up Screen	For setting a captured image as the Start-up Screen	Default

# Deleting Images

Delete images that you do not want to keep.

## Deleting a Single Image

You can delete a single image.



Protected images cannot be deleted.

**1** Enter  mode and use the four-way controller (◀▶) to choose the image you want to delete.

**2** Press the  button.  
A confirmation screen appears.

**3** Use the four-way controller (▲) to select [Delete].

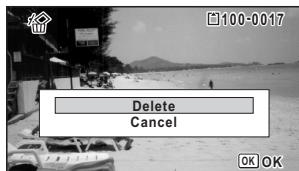

**4** Press the OK button.  
The image is deleted.

## Main Specifications

Type	Fully automatic compact digital camera with built-in zoom lens
Number of Effective Pixels	Approx. 16 megapixels
Image Sensor	1/2.3 inch CMOS
Number of Recorded Pixels	<p>Still <b>16M</b> (4608 x 3456), <b>12M</b> (3456 x 3456), <b>12M</b> (4608 x 2592), <b>7M</b> (3072 x 2304), <b>5M</b> (3072 x 1728), <b>5M</b> (2592 x 1944), <b>4M</b> (2592 x 1464), <b>3M</b> (2048 x 1536), <b>2M</b> (1920 x 1080), <b>1024</b> (1024 x 768), <b>640</b> (640 x 480)</p> <p>* <b>12M</b> / <b>5M</b> / <b>4M</b> / <b>2M</b> in Digital Microscope mode. (When the Recorded Pixels other than <b>2M</b> is selected, only the optical zoom is available.)</p> <p>* <b>5M</b> / <b>4M</b> in Burst Shooting mode.</p> <p>* <b>3M</b> / <b>2M</b> / <b>1280</b> in Report mode.</p> <p>* <b>5M</b> / <b>4M</b> in Original Frame mode.</p> <p>Movie <b>1920</b> (1920 x 1080/30fps), <b>1280</b> (1280 x 720/60fps) <b>1280</b> (1280 x 720/30 fps)</p>
Sensitivity	<p>AUTO, Manual (ISO 125, 200, 400, 800, 1600, 3200, 6400)</p> <p>* The sensitivity is fixed at AUTO (125-6400) in Digital SR mode.</p>
File Formats	<p>Still JPEG (Exif 2.3), DCF 2.0, PRINT Image Matching III</p> <p>Movie MPEG-4 AVC/H.264, approx. 60 fps/30 fps, PCM system, monaural sound, Movie SR (Movie Shake Reduction)</p>
Image Tone	<p>Still Bright, Natural, Vibrant, Slide Film, Monochrome, Cross Processing</p> <p>* The values that can be set vary depending on the shooting mode.</p>
Quality Level	<p>Still ★★★ (Best), ★★ (Better), ★ (Good)</p> <p>Movie Fixed at ★★★ (Best) *Unchangeable</p>
Storage Media	Built-in memory (approx. 68 MB), SD Memory Card, SDHC Memory Card, SDXC Memory Card (up to 512 GB)

Approximate Image Storage Capacity and Recording Time  
Still

	Built-in Memory			2 GB SD Memory Card		
	★★★	★★	★	★★★	★★	★
<b>16M</b> (4608 x 3456)	13	23	38	370	653	1078
<b>12M</b> <b>16M</b> (3456 x 3456)	15	30	46	435	853	1307
<b>12M</b> <b>16M</b> (4608 x 2592)	15	30	46	435	853	1307
<b>7M</b> (3072 x 2304)	23	43	69	653	1205	1921
<b>5M</b> <b>16M</b> (3072 x 1728)	27	53	76	778	1499	2119
<b>5M</b> (2592 x 1944)	27	53	76	778	1499	2119
<b>4M</b> <b>16M</b> (2592 x 1464)	36	69	99	1024	1921	2794
<b>3M</b> (2048 x 1536)	43	85	124	1205	2364	3415
<b>2M</b> (1600 x 1200)	69	124	167	1921	3415	4728
<b>2M</b> <b>16M</b> (1920 x 1080)	63	114	167	1756	3235	4728
<b>1280</b> (1280 x 960)	99	181	256	2794	5122	6830
<b>1024</b> (1024 x 768)	150	256	335	4098	6830	8782
<b>640</b> (640 x 480)	311	484	545	8782	12295	15368

- The image storage capacity is for reference only. The actual image storage capacity may vary depending on the SD Memory Card and the subject.
- **2M** (1600x1200) and **1280** (1280x960) can be set only when  (Report) mode is set.

Movie

	Built-in Memory	2 GB SD Memory Card
<b>1920</b> (1920 x 1080/30 fps)	34 sec.	17 min. 2 sec.
<b>1280</b> (1280 x 720/60 fps)	34 sec.	17 min. 2 sec.
<b>1280</b> (1280 x 720/30 fps)	55 sec.	27 min. 38 sec.

- The above figures are based on our standard shooting conditions and may vary depending on the subject, shooting conditions and type of the SD Memory Card used.
- The maximum length of continuous recording time for a movie is 25 minutes.

White Balance	Auto, Daylight, Shade, Tungsten Light, Fluorescent Light (Daylight Colors/Daylight White/White Light), Manual	
Lens	Focal Length	5.0 - 25.0 mm (approx. 28 - 140 mm in 35 mm format equivalent)
	Maximum Aperture	F3.5 (W) - F5.5 (T)
	Lens Construction	11 elements in 9 groups (5 aspherical elements)
	Zoom Type	Electrically driven
Optical Zoom	5x	
Intelligent Zoom	<b>7M</b> / <b>5M</b> <sub>DS</sub> : approx. 7.5x, <b>5M</b> / <b>4M</b> <sub>DS</sub> : approx. 8.9x, <b>3M</b> : approx. 11.3x, <b>2M</b> <sub>DS</sub> : approx. 12x, <b>1024</b> : approx. 22.5x, <b>640</b> : approx. 36x (when combined with optical zoom)	
Digital Zoom	Max. approx. 7.2x (combines with 5x optical zoom to give zoom magnification equivalent to 36x)	
Motion Blur Reduction	Still	Electronic Shake Reduction (Pixel Track SR), Hi-sensitivity Shake Reduction (Digital SR)
	Movie	Electronic Movie Shake Reduction (Movie SR)
Display	2.7 inch wide-LCD, approx. 230,000 dots (AR coating (cover only))	
Playback Modes	Single-frame, 6-frame, 12-frame, Magnified view (max. 10x, scrollable), Folder Display, Calendar Display, Histogram Display, Highlight/Shadow Area Alert, Select & Delete, Slideshow, Resize, Cropping, Image Copy, Image Rotation, Digital Filter, HDR Filter, Original Frame, Ink Rubbing Filter, Collage, Small Face Filter, Movie Playback/Edit (Save as Still image, Divide, Adding title picture), Red-eye Edit, Protect, Start-up Screen	
Focus Mode	Autofocus, Macro, 1cm Macro, Pan Focus, Infinity, Manual Focus	
Focus	Type	TTL contrast detection system by sensor Multiple (9-point autofocus)/spot/automatic tracking changeable
	Focus Range (From lens face)	Standard : 0.5 m - ∞ (Entire zoom range) Macro : 0.1 m - 0.6 m (Entire zoom range) 1cm Macro : 0.01 m - 0.3 m (Mid-zoom to telephoto)
		* It is possible to switch to Infinity, Pan Focus and Manual Focus. * Face Detection AF is available only when the camera recognizes the subject's face.
	Focus Lock	By half-pressing the shutter release button
Exposure Control	AE Metering	Multi-segment metering, Center-weighted metering, Spot AE metering
	EV Compensation	±2 EV (can be set in 1/3 EV steps)
Face Detection	Detection of up to 32 people's faces (up to 31 face detection frames on the display), Smile Capture, Blink Detection, Self-portrait Assist, Self-portrait Assist + Smile Capture * Face Detection AE is available only when the camera detects the subject's face.	
Pet Detection	Detectable number of pets: 1	

Shooting Mode	Auto Picture, Program, HDR, Handheld Night Snap, Movie, Underwater, Underwater Movie, Digital Microscope, Landscape, Flower, Portrait, Interval Shot, Interval Movie, High Speed Movie, Digital SR, Surf & Snow, Kids, Pet, Sport, Night Scene, Night Scene Portrait, Fireworks, Food, Report	
Digital Filter	B&W/Sepia, Toy Camera, Retro, Color (red, pink, purple, blue, green, yellow), Extract Color (red, green, blue), Color Emphasis (Sky Blue, Fresh Green, Delicate Pink, Autumn Leaves), High Contrast, Starburst (Cross, Heart, Star), Soft, Fish-eye, Brightness, Miniature	
Movie	Continuous Recording Time	Approx. 1 second - 25 minutes (however, only until the built-in memory or SD Memory Card is full)
Shutter Speed	1/4000 sec. - 1/4 sec. (mechanical and electronic shutters), max. 4 sec. (Night Scene mode)	
Built-in Flash	Modes	Auto, Flash Off, Flash On, Auto + Red-eye, Flash On + Red-eye, Macro Light
	Flash Range (Except Macro Light)	Wide-angle: approx. 0.2 - 5.5 m (approx. 0.66 - 18 ft.) (Sensitivity: AUTO) Telephoto: approx. 0.2 - 3.5 m (approx. 0.66 - 11 ft.) (Sensitivity: AUTO)
Drive Mode	Single-frame, Self-timer (10 sec., 2 sec.), Continuous Shooting, Burst Shooting, Remote Control (0 sec., 3 sec.), Auto Bracketing	
Self-timer	Electronic control type, control time: Approx. 10 sec., 2 sec.	
Time Function	World Time	75 cities (28 time zones)
	Clock Display	Clock Display by holding down <b>OK</b> button while camera is turned off (for approx. 10 sec.)
	Alarm	Alarm with simultaneous display of the Clock Display at specified time
Power Source	Rechargeable lithium-ion battery D-LI92	
Battery Life	Image Storage Capacity Approx. 300 pictures	* Recording capacity shows the approximate number of shots recorded during CIPA-compliant testing (at 23°C (73.4°F) with display on and flash used for 50% of the shots). Actual performance may vary according to operating conditions.
	Playback Time Approx. 260 min.	* According to the results of in-house testing.
	Movie Recording Time Approx. 90 min.	* According to the results of in-house testing.
Interfaces	USB 2.0 (Micro-B) /HDMI output terminal (Type D)	
Waterproof and Dustproof Rating	JIS waterproof grade 8 and JIS dustproof grade 6 (IP68) Continuous underwater shooting possible for 2 hours at depth of 14 m.	
Impact Resistance Rating	Our drop test (1.6 m height onto a 5 cm thick plywood surface) complying with MIL-Standard 810F Method 516.5-Shock testing. * Waterproof performance is not guaranteed if the camera is exposed to impact such as being dropped or hit. * The camera is not guaranteed to be free of trouble or damages under every condition.	
Dimensions	Approx. 122.5 (W) x 61.5 (H) x 29.5 (D) mm (approx. 4.8 (W) x 2.4 (H) x 1.2 (D) inches) (excluding operating or protruding parts)	

Weight	Approx. 173 g (approx. 6.1 oz.) (excluding battery and SD Memory Card) Approx. 194 g (approx. 6.8 oz.) (including battery and SD Memory Card)
Accessories	Rechargeable lithium-ion battery, USB power adapter, USB cable, Strap, Macro stand, Start Guide, Regarding Waterproof, Dustproof, and Shockproof Design

### USB Power Adapter AC-U2

Power Supply	100 to 240 VAC (50/60 Hz), 0.2 A
Output	5.0 VDC, 1000 mA, 5.0 W
Average Active Efficiency	76.8 %
No-Load Power Consumption	70 mW
Temperature	10 to 40°C (50 to 104°F)
Dimensions	Approx. 42.5 mm (W) x 22 mm (H) x 66.5 mm (D) (approx. 1.7 in. (W) x 0.9 in. (H) x 2.6 in. (D)) (excluding the power plug)
Weight	Approx. 40 g (approx. 1.4 oz) (excluding the power plug)

### Rechargeable Battery D-LI92

Nominal Voltage	3.7 V
Rated Capacity	925 mAh, 3.5 Wh
Operating Temperature	0 to 45°C (32 to 113°F)
Storage Temperature	-20 to 50°C (-4 to 122°F)
Dimensions	Approx. 39.8 mm (W) x 34.2 mm (H) x 6.8 mm (D) (approx. 1.57 in. (W) x 1.35 in. (H) x 0.27 in. (D))
Weight	Approx. 20 g (approx. 0.7 oz)

## Warranty Policy

All our cameras purchased through authorized bona fide photographic distribution channels are guaranteed against defects of material or workmanship for a period of twelve months from the date of your purchase. Service will be rendered, and defective parts will be replaced without cost to you within that period, provided the camera does not show evidence of impact, sand or liquid damage, mishandling, tampering, battery or chemical corrosion, operation contrary to operating instructions, or modification by an unauthorized repair shop. The manufacturer or its authorized representatives shall not be liable for any repair or alterations except those made with its written consent and shall not be liable for damages from delay or loss of use or from other indirect or consequential damages of any kind, whether caused by defective material or workmanship or otherwise; and it is expressly agreed that the liability of the manufacturer or its representatives under all guarantees or warranties, whether expressed or implied, is strictly limited to the replacement of parts as hereinbefore provided. No refunds will be made on repairs by non-authorized service facilities.



### Procedure During 12-month Warranty Period

Any camera which proves defective during the 12-month warranty period should be returned to the dealer from whom you purchased the camera or to the manufacturer. If there are no representatives of the manufacturer in your country, send the camera to the manufacturer, with postage prepaid. In this case, it will take a considerable length of time before the camera can be returned to you owing to the complicated customs procedures required. If the camera is covered by warranty, repairs will be made and parts replaced free of charge, and the camera will be returned to you upon completion of servicing. If the camera is not covered by warranty, regular charges of the manufacturer or of its representatives will apply. Shipping charges are to be borne by the owner. If your camera was purchased outside of the country where you wish to have it serviced during the warranty period, regular handling and servicing fees may be charged by the manufacturer's representatives in that country. Notwithstanding this, your camera returned to the manufacturer will be serviced free of charge according to this procedure and warranty policy. In any case, however, shipping charges and customs clearance fees to be borne by the sender. To prove the date of your purchase when required, please keep the receipt or bills covering the purchase of your camera for at least a year. Before sending your camera for servicing, please make sure that you are sending it to the manufacturer's authorized representatives or their approved repair shops, unless you are sending it directly to the manufacturer. Always obtain a quotation for the service charge, and only after you accept the quoted service charge, instruct the service station to proceed with the servicing.

- **This warranty policy does not affect the customer's statutory rights.**
- **The local warranty policies available from our distributors in some countries can supersede this warranty policy. Therefore, we recommend that you review the warranty card supplied with your product at the time of purchase, or contact our distributor in your country for more information and to receive a copy of the warranty policy.**

### Notice to Users in CE marking

This product complies with the essential requirements and provisions of EMC Directive 2014/30/EU.

Importer(CE marking) : RICOH IMAGING EUROPE S.A.S.

Parc Tertiaire SILIC 7-9, avenue Robert Schuman - B.P. 70102, 94513 Rungis Cedex, FRANCE

Manufacturer : RICOH IMAGING COMPANY,LTD.

1-3-6, Nakamagome, Ohta-ku, Tokyo 143-8555, JAPAN



The CE Mark is a Directive conformity mark of the European Union.

### Notice to Users in UKCA marking

This product complies with the essential requirements and provisions of Electromagnetic Compatibility Regulations 2016.

Manufacturer : RICOH IMAGING COMPANY,LTD.

1-3-6, Nakamagome, Ohta-ku, Tokyo 143-8555, JAPAN



The UKCA Mark is a Regulation conformity mark of the United Kingdom.

## **For customers in USA**

### **STATEMENT OF FCC COMPLIANCE**

This device complies with Part 15 of the FCC Rules. Operation is subject to the following two conditions: (1) This device may not cause harmful interference, and (2) this device must accept any interference received, including interference that may cause undesired operation.

Changes or modifications not approved by the party responsible for compliance could void the user's authority to operate the equipment.

This equipment has been tested and found to comply with the limits for a Class B digital device, pursuant to part 15 of the FCC Rules.

These limits are designed to provide reasonable protection against harmful interference in a residential installation. This equipment generates, uses and can radiate radio frequency energy and, if not installed and used in accordance with the instructions, may cause harmful interference to radio communications.

However, there is no guarantee that interference will not occur in a particular installation.

If this equipment does cause harmful interference to radio or television reception, which can be determined by turning the equipment off and on, the user is encouraged to try to correct the interference by one or more of the following measures:

- Reorient or relocate the receiving antenna.
- Increase the separation between the equipment and receiver.
- Connect the equipment into an outlet on a circuit different from that to which the receiver is connected.

\*Consult the dealer or an experienced radio/TV technician for help.

## **For customers in Canada**

Innovation, Science and Economic Development Canada (ISED) Regulatory Compliance Notice.

This Class B digital apparatus complies with Canadian ICES-003 (B).

## **Pour les utilisateurs au Canada**

Avis de conformité à la réglementation d'Innovation, Sciences et Développement économique Canada (ISDE).

Cet appareil numérique de la classe B est conforme à la norme NMB-003 (B) du Canada.

## **FOR CALIFORNIA, U.S.A. ONLY**

Perchlorate Material-special handling may apply. The lithium battery used in this camera contains perchlorate material, which may require special handling. See [www.dtsc.ca.gov/hazardouswaste/perchlorate](http://www.dtsc.ca.gov/hazardouswaste/perchlorate)

**Declaration of Conformity**  
According to 47CFR, Parts 2 and 15 for  
**Class B Personal Computers and Peripherals**

We: RICOH IMAGING AMERICAS  
CORPORATION

Located at: 2 Gatehall Drive Suite 204, Parsippany,  
New Jersey 07054, U.S.A.  
Phone: 800-877-0155

Declare under sole responsibility that the product identified herein complies with 47CFR Parts 2 and 15 of the FCC rules as a Class B digital device. Each product marketed is identical to the representative unit tested and found to be compliant with the standards. Records maintained continue to reflect the equipment being produced can be expected to be within the variation accepted, due to quantity production and testing on the statistical basis as required by 47CFR §2.909. Operation is subject to the following two conditions: (1) This device may not cause harmful interference, and (2) This device must accept any interference received, including interference that may cause undesired operation. The above named party is responsible for ensuring that the equipment complies with the standards of 47CFR §15.101 to §15.109.

Product Name: Digital Camera

Model Number: R06020

Contact person: Customer Service Manager

Date and Place: February, 2022, Parsippany

## Information for Users on Collection and Disposal of Old Equipment and Used Batteries

### 1. In the European Union



These symbols on the products, packaging and/or accompanying documents mean that used electrical and electronic equipment and batteries should not be mixed with general household waste.

Used electrical/electronic equipment and batteries must be treated separately and in accordance with legislation that requires proper treatment, recovery and recycling of these products.

By disposing of these products correctly you will help ensure that the waste undergoes the necessary treatment, recovery and recycling and thus prevent potential negative effects on the environment and human health which could otherwise arise due to inappropriate waste handling.

If a chemical symbol is added beneath the symbol shown above, in accordance with the Battery Directive, this indicates that a heavy metal (Hg = Mercury, Cd = Cadmium, Pb = Lead) is present in the battery at a concentration above an applicable threshold specified in the Battery Directive.

For more information about collection and recycling of used products, please contact your local authorities, your waste disposal service or the point of sale where you purchased the products.

### 2. In other countries outside the EU

These symbols are only valid in the European Union. If you wish to discard used products, please contact your local authorities or dealer and ask for the correct method of disposal.

For Switzerland: Used electrical/electronic equipment can be returned free of charge to the dealer, even when you don't purchase a new product. Further collection facilities are listed on the home page of [www.swico.ch](http://www.swico.ch) or [www.sens.ch](http://www.sens.ch).

## Information on the Operating Manual

An Operating Manual (PDF) containing information on how to use this camera is available. Please download it from our website.



### **Operating Manual Download:**

<https://www.ricoh-imaging.com/manuals/>

## Regarding User Registration

In order to better serve you, we request that you complete the user registration, which can be found on our website. Thank you for your cooperation.

<https://www.ricoh-imaging.com/registration/>

# Memo

# Memo

**RICOH IMAGING COMPANY, LTD.**

1-3-6, Nakamagome, Ohta-ku, Tokyo 143-8555, JAPAN  
(<https://www.ricoh-imaging.co.jp>)

**RICOH IMAGING EUROPE  
S.A.S.**

Parc Tertiaire SILIC 7-9, avenue Robert Schuman -  
B.P. 70102, 94513 Rungis Cedex, FRANCE  
(<https://www.ricoh-imaging.eu>)

**RICOH IMAGING  
AMERICAS CORPORATION**

2 Gatehall Drive Suite 204, Parsippany, New Jersey  
07054, U.S.A.  
(<https://www.us.ricoh-imaging.com>)

**RICOH IMAGING CANADA  
INC.**

5560 Explorer Drive Suite 100, Mississauga, Ontario,  
L4W 5M3, CANADA  
(<https://www.ricoh-imaging.ca>)

**RICOH IMAGING CHINA  
CO., LTD.**

Room A 23F Lansheng Building, 2-8 Huaihaizhong  
Road, Huangpu District, Shanghai, 200021, CHINA  
(<http://www.ricoh-imaging.com.cn>)

<https://www.ricoh-imaging.co.jp/english/>

This contact information may change without notice.  
Please check the latest information on our websites.

- Specifications and external dimensions are subject to change without notice.