

**SC-T5100 Series**  
**SC-T3100 Series**  
**SC-T5100N Series**  
**SC-T3100N Series**

**User's Guide**

---

**Contents**

**Contents**

**Introduction**

Notes on Manuals. . . . . 5  
 Meaning of Symbols. . . . . 5  
 Illustrations. . . . . 5  
 Product Model Descriptions. . . . . 5  
 Manual Organization. . . . . 5  
 Viewing PDF Manuals. . . . . 5  
 Printer Parts. . . . . 7  
 Front. . . . . 7  
 Inside. . . . . 9  
 Back. . . . . 11  
 Control panel. . . . . 13  
 Home screen operations. . . . . 13  
 Features of Printer. . . . . 16  
 Realizing High Resolution. . . . . 16  
 Insistence on Ease-of-Use. . . . . 16  
 Notes on Usage and Storage. . . . . 17  
 Installation space. . . . . 17  
 Notes when using the printer. . . . . 18  
 Notes when not using the printer. . . . . 18  
 Notes on handling ink cartridges. . . . . 19  
 Notes on handling paper. . . . . 20  
 Saving Power. . . . . 21

**Introducing the Software**

Provided Software. . . . . 22  
 Built-in Software in the Printer. . . . . 23  
 How to Use Web Config. . . . . 24  
 How to Start. . . . . 24  
 Closing. . . . . 24  
 Function Summary. . . . . 24  
 Updating Software or Installing Additional Software. . . . . 25  
 Checking Whether Updates Available and Updating Software. . . . . 25  
 Receiving Update Notifications. . . . . 25  
 Uninstalling Software. . . . . 26  
 Windows. . . . . 26  
 Mac. . . . . 26

**Loading and Setting the Paper**

Notes on Loading the Paper. . . . . 27  
 Paper Load Position. . . . . 27  
 Loading and Removing the Roll Paper. . . . . 28

Loading Roll Paper. . . . . 28  
 Cutting the Roll Paper. . . . . 30  
 Removing Roll Paper. . . . . 32  
 Loading and Removing Paper in/from the Auto Sheet Feeder. . . . . 34  
 Attaching and Removing the Stacker (for Plain Paper). . . . . 34  
 Loading Paper in the Auto Sheet Feeder. . . . . 34  
 Removing Paper from the Auto Sheet Feeder. . . . . 36  
 Loading and Removing Cut Sheet(1 sheet). . . . . 37  
 Loading Cut Sheet(1 sheet). . . . . 37  
 Removing Cut Sheet (1 Sheet). . . . . 38  
 Setting Loaded Paper. . . . . 39  
 For Roll Paper. . . . . 39  
 For Auto Sheet Feeder / Cut Sheet(1 sheet). . . . . 41  
 Optimizing Paper Settings (Media Adjust). . . . . 43  
 Notes on Making Adjustments. . . . . 43  
 Adjustment Procedure. . . . . 43

**Printing with the Printer Driver from Your Computer**

Basic Operating Procedures (Windows). . . . . 46  
 Printing Procedure. . . . . 46  
 Canceling Printing. . . . . 48  
 Customizing the Printer Driver. . . . . 49  
 Basic Operating Procedures (Mac). . . . . 52  
 Printing Procedure. . . . . 52  
 Canceling Printing. . . . . 55  
 Customizing the Printer Driver. . . . . 55  
 Printing CAD Drawings. . . . . 57  
 Enlargements and Horizontal and Vertical Banners. . . . . 59  
 Fitting Documents to the Width of the Roll Paper. . . . . 60  
 Fitting Documents to the Output Size. . . . . 61  
 Choosing a Print Size. . . . . 63  
 Printing at Non-Standard Sizes. . . . . 64  
 Correct color and print. . . . . 68  
 Color Management Printing. . . . . 72  
 About Color Management. . . . . 72  
 Color Management Print Settings. . . . . 72  
 Setting color management with the applications. . . . . 73  
 Setting color management with the printer driver. . . . . 75  
 Multi-Page Printing (N-up). . . . . 79

## Contents

Manual 2-Sided Printing (Windows Only) . . . . .	80
Notes on Using 2-Sided Printing. . . . .	80
Setting Procedures for Printing. . . . .	80
Folded 2-Sided Printing (Windows only). . . . .	82
Poster Printing (Windows Only). . . . .	83
Printing Multiple Documents (Layout Manager) (Windows Only). . . . .	88
Setting Procedures for Printing. . . . .	88
Saving and Recalling Settings. . . . .	89

### **Printing Using the HP-GL/2 or HP RTL Mode from a Computer**

Printer Settings. . . . .	91
Basic Print Settings. . . . .	91
HP-GL/2 Specific Print Settings. . . . .	91
CAD Application Settings. . . . .	92

### **Changing the Network Connection Methods**

Switching to Wired LAN. . . . .	93
Switching to Wireless LAN. . . . .	93
Directly Connection Wirelessly (Wi-Fi Direct). . . . .	94

### **Printing Using AirPrint**

### **Making Enlarged Copies with an A3 or A4 Scanner**

Connecting the Scanner. . . . .	96
Making Enlarged Copies. . . . .	97
Placing Documents in the Scanner. . . . .	97

### **Using the Menu**

Menu List. . . . .	99
Paper Setting menu. . . . .	109
Roll Paper menu. . . . .	109
Auto Sheet Feeder menu. . . . .	112
Cut Sheet(1 sheet) menu. . . . .	113
Printer Status menu. . . . .	114
Settings menu. . . . .	115
General Settings. . . . .	115
Maintenance. . . . .	131
Printer Status/Print. . . . .	132
Enlarged Copy menu. . . . .	133

## **Maintenance**

Clear Print Head Clogs. . . . .	134
Checking for Clogged Print Head, and Cleaning. . . . .	134
Powerful Cleaning. . . . .	134
Replacing Consumables. . . . .	135
Handling of Used Consumables. . . . .	135
Replacing Ink Cartridges. . . . .	135
Maintenance Box Replacement. . . . .	137
Replacing the Cutter. . . . .	138

## **Problem Solver**

What to do When a Message is Displayed. . . . .	140
When a Maintenance Call/Printer Error Occurs. . . . .	141
Troubleshooting. . . . .	142
You cannot print (because the printer does not work). . . . .	142
The printer sounds like it is printing, but nothing prints. . . . .	144
The prints are not what you expected. . . . .	145
Feeding or ejecting problems. . . . .	150
Others. . . . .	152

## **Appendix**

Options and Consumable Products. . . . .	154
Epson Special Media. . . . .	154
Ink cartridges. . . . .	154
Others. . . . .	155
Supported Media. . . . .	157
Epson Special Media Table. . . . .	157
Supported Commercially Available Paper. . . . .	160
Printable area. . . . .	163
Roll Paper. . . . .	163
Cut Sheet (Auto Sheet Feeder). . . . .	165
Cut Sheet (1 Sheet). . . . .	165
Moving or Transporting the Printer. . . . .	166
Moving to a Different Location in the Same Building. . . . .	166
When Transporting. . . . .	167
Handling if Transporting/Leaving the Printer in an Environment of -10°C or Less. . . . .	167
System Requirements. . . . .	169
Printer Driver. . . . .	169
Web Config. . . . .	170
Specifications Table. . . . .	171
For European users. . . . .	172

**Contents**

***Where To Get Help***





Technical Support Web Site. . . . .	174
Contacting Epson Support. . . . .	174
Before Contacting Epson. . . . .	174
Help for Users in North America. . . . .	175
Help for Users in Europe. . . . .	175
Help for Users in Australia. . . . .	175
Help for Users in Singapore. . . . .	176
Help for Users in Thailand. . . . .	176
Help for Users in Vietnam. . . . .	176
Help for Users in Indonesia. . . . .	176
Help for Users in Hong Kong. . . . .	177
Help for Users in Malaysia. . . . .	177
Help for Users in India. . . . .	177
Help for Users in the Philippines. . . . .	178

Introduction

# Introduction

## Notes on Manuals

### Meaning of Symbols

 <b>Warning:</b>	Warnings must be followed to avoid serious bodily injury.
 <b>Caution:</b>	Cautions must be followed to avoid bodily injury.
 <b>Important:</b>	Important must be followed to avoid damage to this product.
<b>Note:</b>	Notes contain useful or additional information on the operation of this product.
	Indicates related reference content.

## Illustrations

The illustrations may differ slightly from the model you are using. Please be aware of this when using the manuals.

## Product Model Descriptions

Some models described in this manual may not be sold in your country or region.

## Manual Organization

The manuals for the product are organized as shown below.

You can view the PDF manuals using Adobe Acrobat Reader or Preview (Mac).

Setup Guide (booklet)	Provides information on how to setup the printer after unpacking it from the box. Make sure you read this manual to perform operations safely.
Operator's Guide (booklet or PDF)	Provides selected information on how to use the printer and frequently used features of the printer.
General Information (PDF)	Provides important safety instructions, printer specifications and contact details.
Online Manual	
User's Guide (this manual)	Provides overall information and instructions on using the printer and on solving problems.
Administrator's Guide (PDF)	Provides network administrators with information on management and printer settings.

## Viewing PDF Manuals

This section uses the Adobe Acrobat Reader DC as an example to explain the basic operations for viewing the PDF in Adobe Acrobat Reader.

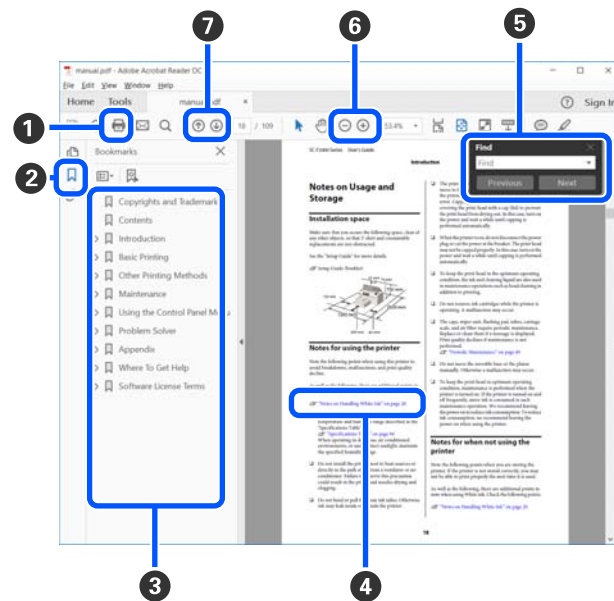

- 1 Click to print the PDF manual.

## Introduction

- Each time it is clicked the bookmarks are hidden or shown.

- Click the title to open the relevant page.

Click [+] to open the titles lower in the hierarchy.

- If the reference is in blue text, click the blue text to open the relevant page.

To return to the original page, do the following.

### For Windows

While pressing the Alt key, press the ← key.

### For Mac

While pressing the command key, press the ← key.

- You can input and search for keywords, such as the names of items you want to confirm.

### For Windows

Right click on a page in the PDF manual and select **Find** in the menu that is displayed to open the search toolbar.

### For Mac

Select **Find** in the **Edit** menu to open the search toolbar.

- To enlarge the text in the display that is too small to see well, click (+). Click (-) to reduce the size. To specify a part of an illustration or screenshot to enlarge, do the following.

### For Windows

Right click on the page in the PDF manual and select **Marquee Zoom** in the menu that is displayed. The pointer changes to a magnifying glass, use it to specify the range of the place you want to enlarge.

### For Mac

Click **View** menu - **Zoom** - **Marquee Zoom** in this order to change the pointer to a magnifying glass. Use the pointer as a magnifying glass to specify the range of the place you want to enlarge.

- Opens the previous page or next page.

Introduction

# Printer Parts

## Front

The illustration shows the SC-T3100 Series (24 inch model with stand).

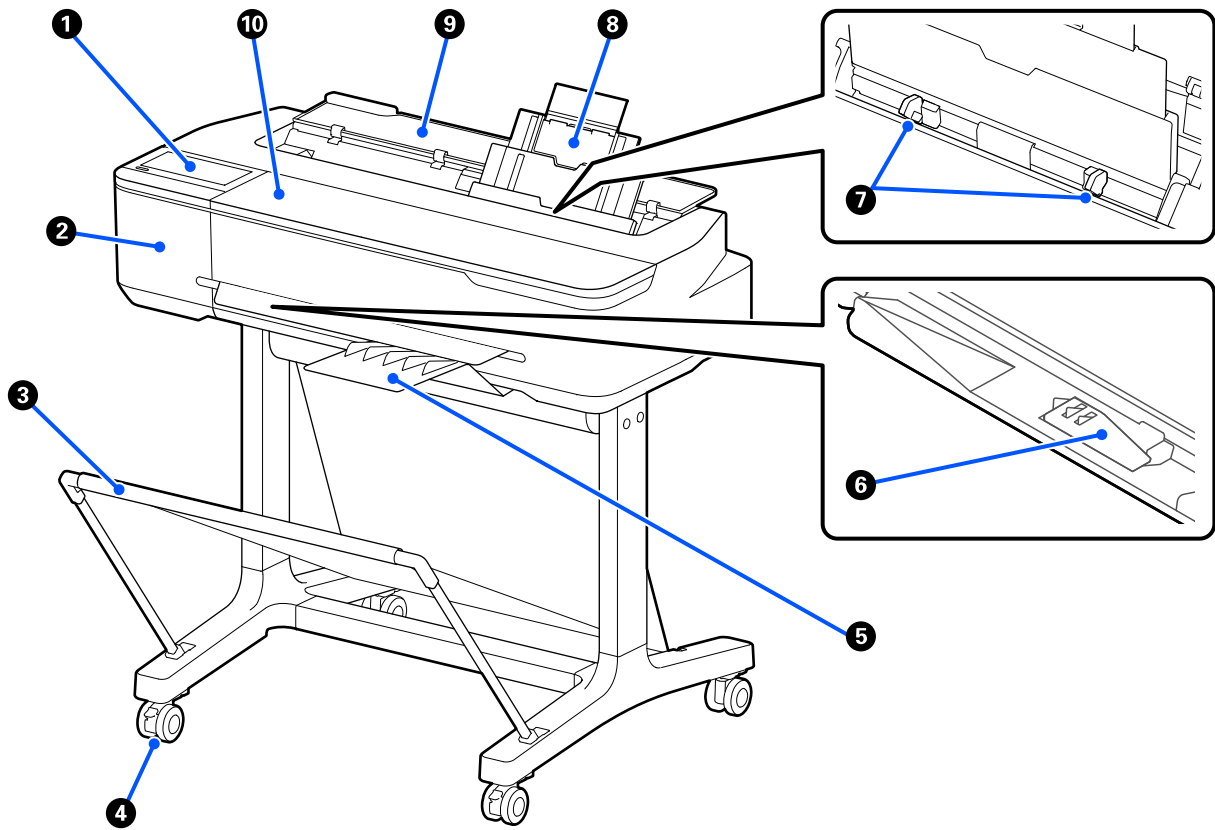

**1 Control panel**

[“Control panel” on page 13](#)

**2 Cutter cover**

Open when replacing the cutter.

[“Replacing the Cutter” on page 138](#)

**3 Paper basket**

Output from the printer collects in this basket, keeping the media clean and free of creases.

A dedicated stand that comes with a paper basket is provided as an option for SC-T3100N Series and SC-T5100N Series.

[“Options and Consumable Products” on page 154](#)

## Introduction

### 4 Casters

There are two casters on each leg. The casters are normally kept locked once the printer is in place.

### 5 Stacker (for plain paper)

Attach this stacker to the front of the printer in this way when continuously printing multiple sheets of plain paper from the auto sheet feeder. The printed paper is stacked in this tray after ejection. Remove the stacker when using roll paper or Cut Sheet (1 sheet).

 [“Attaching and Removing the Stacker \(for Plain Paper\)” on page 34](#)

### 6 B1 width paper support (SC-T5100 Series/SC-T5100N Series only)

For roll paper or cut sheet (1 sheet) equivalent to B1 width (718 to 738 mm) only, raise the B1 width paper support before printing to prevent scuffing and soiling of the print surface.

 [“Loading Roll Paper” on page 28](#)

 [“Loading Cut Sheet\(1 sheet\)” on page 37](#)

### 7 Edge guides

Slide these guides against the left and right edges of the paper loaded in the auto sheet feeder. It can prevent paper from being fed skewed.

### 8 Auto sheet feeder

This allows you to load multiple sheets of A3 to A4 cut sheet. The loaded paper is automatically fed and printed continuously.

 [“Loading Paper in the Auto Sheet Feeder” on page 34](#)

### 9 Cut sheet cover

Open this cover when using the auto sheet feeder or when loading a cut sheet of paper.

 [“Loading Cut Sheet\(1 sheet\)” on page 37](#)

When loading roll paper, open this cover and then open the roll paper cover.

To prevent dust from accumulating inside the printer, use the printer with this cover closed when not using the auto sheet feeder and when not loading a cut sheet of paper.

### 10 Front cover

Open this cover when replacing ink cartridges or clearing a paper jam.



## Introduction

---

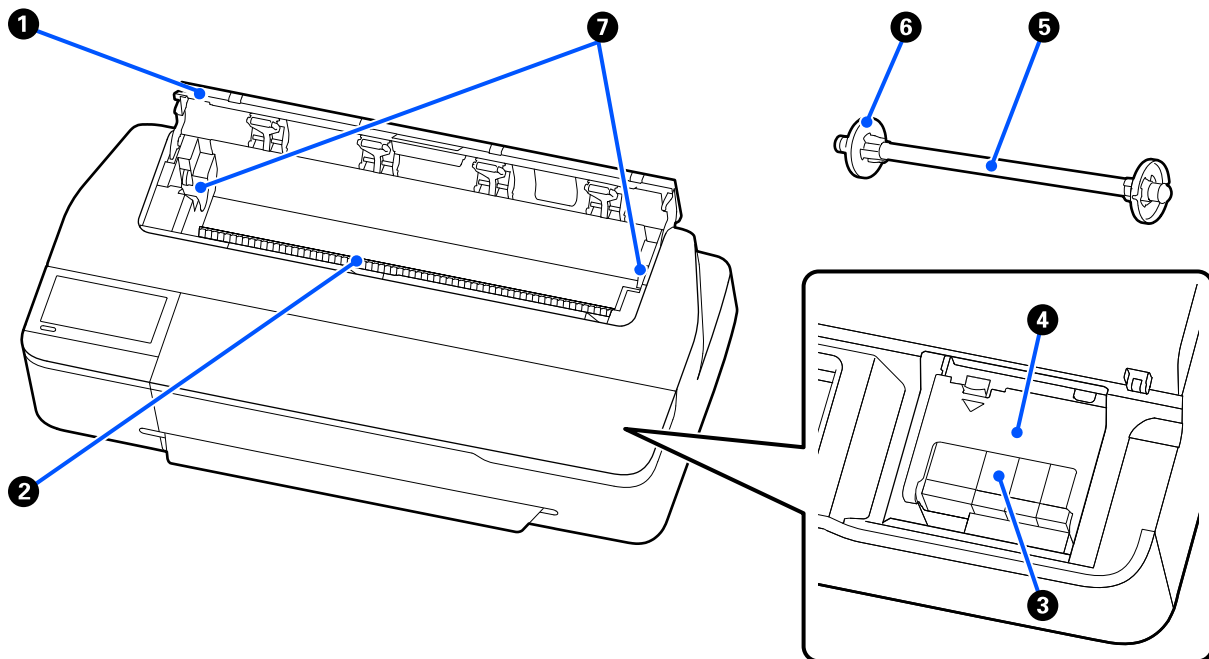
**Inside**
**1 Roll paper cover**

This cover protects the loaded roll paper and prevents dust from entering inside the printer. Except when loading or removing roll paper, it should be closed when using the printer.

 [“Loading Roll Paper” on page 28](#)

**2 Paper slot**

This is the slot through which roll paper or single sheets of cut sheet are fed during printing. Feed single sheets one at a time.

**3 Ink cartridges**

Install cartridges into all slots.

 [“Replacing Ink Cartridges” on page 135](#)

**4 Cartridge cover**

Open when replacing ink cartridges.

**5 Spindle**

When loading roll paper into the printer, insert this through the roll paper.

**6 Movable flange (transparent)**

This fixes the roll paper placed on the spindle. Attach or detach it when placing or removing roll paper on/from the spindle.

## Introduction

### 7 Spindle holder

Place the spindle in this holder after it is attached to the roll paper. There is a holder on both the left and right sides.

 [“Loading Roll Paper” on page 28](#)

## Introduction

### Back

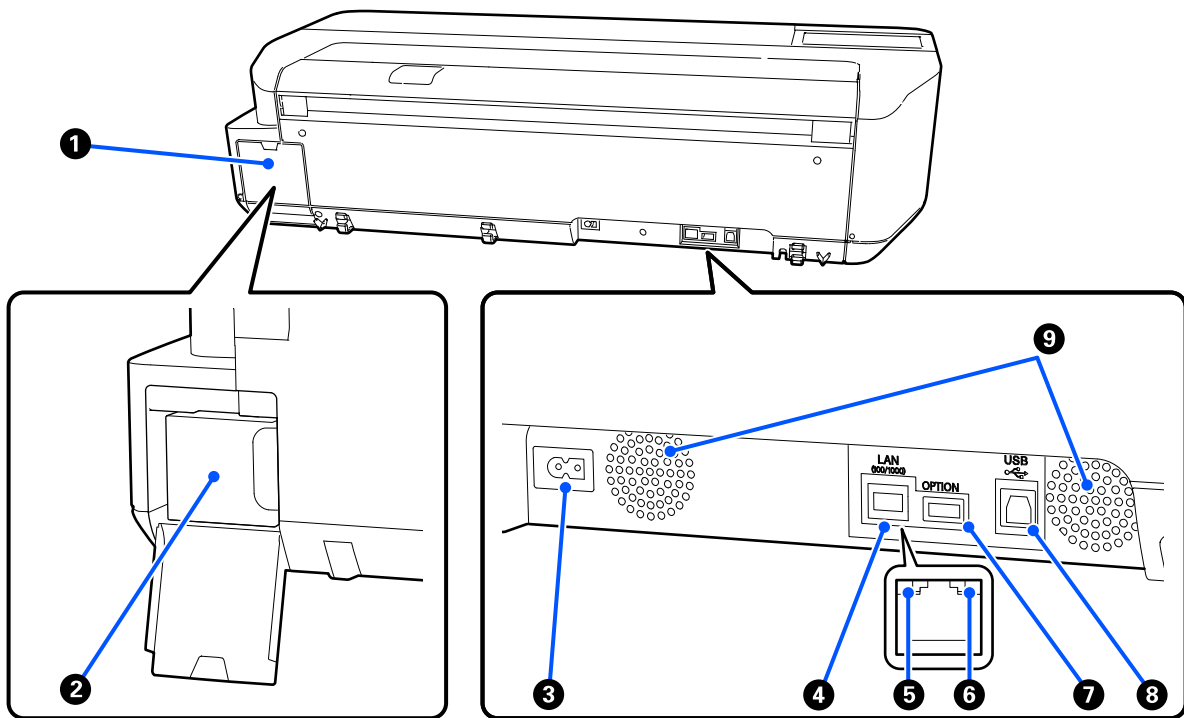

**1 Maintenance box cover**

Open the cover when replacing the Maintenance Box.

**2 Maintenance Box**

This container is for collecting the waste ink.

 [“Maintenance Box Replacement” on page 137](#)

**3 AC inlet**

Connect the supplied power cable here.

**4 LAN port**

Connects the LAN cable.

**5 Status light (green, orange)**

The color indicates the network transmission speed.

Off: 10BASE-T

Orange: 100BASE-T

Green: 1000BASE-T

## Introduction

### ⑥ Data light (yellow)

The network connection status and data reception are indicated by a lit or flashing light.

On: Connected.

Flashing: Receiving data.

### ⑦ OPTION port

Connect a scanner to perform enlarged copying.

 [“Making Enlarged Copies with an A3 or A4 Scanner” on page 96](#)

### ⑧ USB port

Connects the USB cable.

### ⑨ Vents

Do not block the vents.

 [“Installation space” on page 17](#)

## Introduction

### Control panel

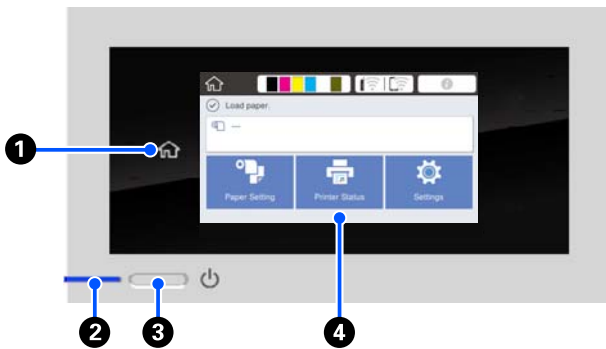

#### 1 Home button

Touch this button while a menu is displayed to return to the Home screen. The home button is off when it cannot be used during operations such as paper feeding.

#### 2 light (power light)

On  : The power is on.

Flashing  : The printer is performing a process such as starting up, powering off, data receiving, or print head cleaning. Please wait without performing any operation until this light stops flashing. Do not disconnect the power cord.

Off  : The power is off.

#### 3 button (power button)

Turns the power on and off.

#### 4 Screen

This is a touch panel to display the printer's status, menus, error messages, and so on. You can select the menu items and options displayed on this screen by gently touching (tapping) them, and scroll the screen by moving your finger while it remains touching the screen.

### Home screen operations

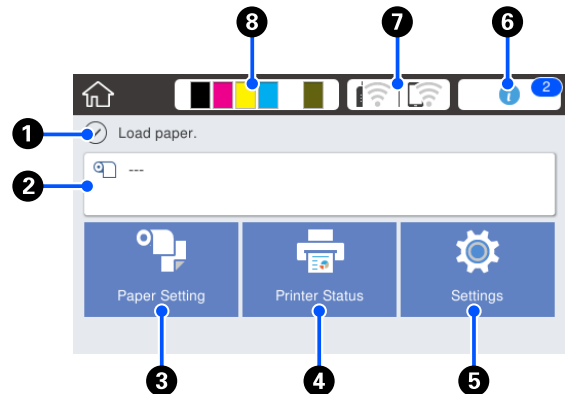

Overview of Home screen operations  *Operator's Guide* (booklet or PDF)

#### 1 Information display area

Displays the printer's status, error messages, and so on.

#### 2 Roll paper information area

- When roll paper is loaded  
Displays information on the loaded roll paper. When Paper Remaining is set to On, the approximate remaining amount (remaining length) is displayed. Touching this area displays a menu to perform operations such as setting and adjusting the roll paper.  
["Roll Paper menu" on page 109](#)
- When roll paper is not loaded  
Displays "---". Touching this area displays the procedure for loading roll paper.

#### 3 Paper Setting menu button

## Introduction

Touch this button when loading, removing, setting, or adjusting paper.

- ❑ See the following for more details on Roll Paper.  
[🔗 “Loading and Removing the Roll Paper” on page 28](#)  
 Menu descriptions [🔗 “Roll Paper menu” on page 109](#)
- ❑ See the following for more details on Auto Sheet Feeder.  
[🔗 “Loading and Removing Paper in/from the Auto Sheet Feeder” on page 34](#)  
 Menu descriptions [🔗 “Auto Sheet Feeder menu” on page 112](#)
- ❑ See the following for more details on Cut Sheet(1 sheet).  
[🔗 “Loading and Removing Cut Sheet\(1 sheet\)” on page 37](#)  
 Menu descriptions [🔗 “Cut Sheet\(1 sheet\) menu” on page 113](#)

### 4 Printer Status menu button

Touch this button when you want to check the status of consumables or details of displayed notifications.

[🔗 “Printer Status menu” on page 114](#)

### 5 Settings menu button

Touch this button when you want to perform maintenance or configure the printer operation settings, network settings, or other settings. See the following for more details.

[🔗 “Settings menu” on page 115](#)

### 6 Information icon







When there are notifications, such as consumable remaining amount low warnings, the number of notifications is indicated by a badge at the top right of this icon. If you touch this icon when the badge is displayed, a list of the notifications that require your action is displayed. Touching each item displays instructions on what to do. If you do not perform the actions, the badge will not disappear.

### 7 Network icon

The network connection status is indicated by an icon as shown below.

Touching the icon allows you to switch the network connection status.

[🔗 “Changing the Network Connection Methods” on page 93](#)

	Not connected to a wired LAN or the wired LAN or wireless LAN not set.
	Connected to a wired LAN.
	Wireless LAN (Wi-Fi) is disabled.
	Searching for SSID, IP address not set, or signal strength is 0 or poor.
	Connected to a wireless LAN (Wi-Fi). The number of lines indicates the signal strength. The more lines there are, the better the signal strength.
	Wi-Fi Direct (simple AP) connection is disabled.
	Wi-Fi Direct (simple AP) connection is enabled.

### 8 Consumables status icon

Estimates of the remaining amounts of ink cartridges and the empty space in the Maintenance Box are indicated by the length of the bars. The shorter a bar is, the lower the remaining amount of ink or space.

When  is displayed, the remaining amount of the corresponding ink cartridge or the amount of empty space in the Maintenance Box is low. Touching the icon displays the consumables status screen so that you can check the ink cartridge and Maintenance Box product numbers. This is a shortcut button for **Supply Status** in the **Printer Status** menu.

[🔗 “Printer Status menu” on page 114](#)

## Introduction

**Note:**

When you connect an Epson A3 or A4 scanner to the printer, **Enlarged Copy** appears to allow you to easily make enlarged copies.

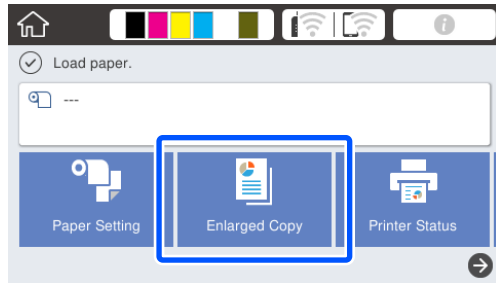

 [“Making Enlarged Copies with an A3 or A4 Scanner” on page 96](#)

## Introduction

# Features of Printer

## Realizing High Resolution

### CAD drawings that are clear, legible, and can even be used safely outdoors

Newly-developed Epson UltraChrome XD2 ink enables the printer to produce extremely detailed drawings both in black and white and in color.

The supplied printer driver offers a line drawing mode, making it easier to optimize printing for line drawing and, through unsurpassed reproduction of line drawing and fine lines in the form of connected lines, diagonals, and curves, ensuring the best possible results when the printer is used for drawings.

In addition, you can even safely take your drawings outdoors with you because they are printed using ink with excellent water resistance.

 [“Printing CAD Drawings” on page 57](#)

### Posters and displays that are vivid and also allow for short-term outdoor display

Posters with vivid hues can be printed simply by selecting, for example, **Poster (Photo)/Perspective** in Select Target of the supplied printer driver.

Short-term outdoor display is even supported since ink that also has excellent light fastness is used.

Your posters will last even longer if you use lamination processing.

The effect differs depending on the paper.

## Insistence on Ease-of-Use

### Space-saving large-format printer

This printer is compact and lightweight compared to previous large-format Epson printers, so you will have no trouble finding a location to place it. The model without a stand can even be placed on a drawing storage cabinet or the like. See the following for dimensions.

 [“Specifications Table” on page 171](#)

### Automatic switching between auto sheet feeder (cut sheet) and roll paper

This printer allows not only roll paper to be loaded but also multiple sheets of A3 size or smaller sheet to be loaded in the auto sheet feeder at the same time. When you select either of these two **Source** settings of the printer driver, the paper is switched automatically to allow you to print easily.

### Smooth operation while checking the operating instructions on the screen

In addition to having a screen design that enables intuitive operation, this printer allows you to check illustrated instructions of operations such as how to load paper.

 [Operator's Guide](#) (booklet or PDF)

### Printer driver that is simple and easy to operate

Print settings can be optimized simply by choosing the desired use or target. This spares you the trouble of adjusting print settings individually. When you select a Source setting, printing failures due to paper loading mistakes are reduced because the size and type of paper loaded in the printer are applied automatically. In addition to checking the set conditions in an illustration in the printer driver, you can also check a detailed image in the preview screen before printing.



**Introduction**

**Support for wireless LAN connection**

This printer can be freely placed where desired without considering cable routing because it can connect with a computer via a wireless LAN to print. Of course, it also supports a wired LAN connection.

Furthermore, even if your device is not connected to a LAN, this printer also allows printing by directly connecting with it using Wi-Fi Direct. From an iOS device, you can also print easily using AirPrint.

 [“Switching to Wireless LAN” on page 93](#)

 [“Directly Connection Wirelessly \(Wi-Fi Direct\)” on page 94](#)

 [“Printing Using AirPrint” on page 95](#)

**Notes on Usage and Storage**

**Installation space**

Make sure that you secure the following space, clear of any other objects, so that paper ejection and consumable replacement are not obstructed.

See the “Specifications Table” for the external dimensions of the printer.

 [“Specifications Table” on page 171](#)

**SC-T5100 Series/SC-T3100 Series**

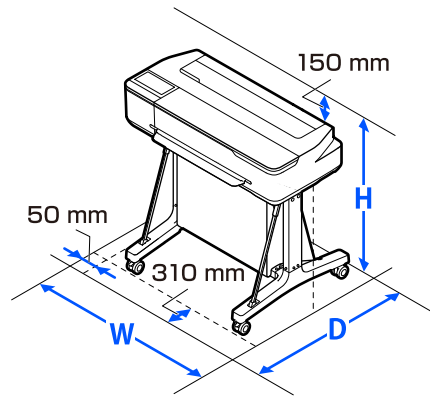

	W	D	H
SC-T5100 Series	1318 mm	1270 mm	1063 mm
SC-T3100 Series	1020 mm	1270 mm	1063 mm

**SC-T5100N Series/SC-T3100N Series**

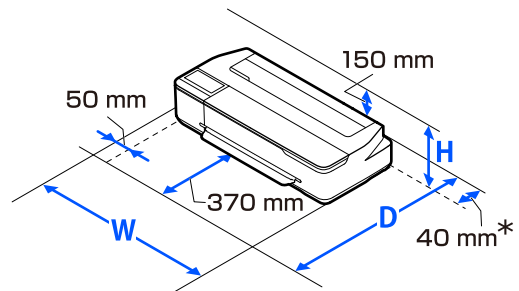

## Introduction

	W	D	H
SC-T5100N Series	1318 mm	915 mm	380 mm
SC-T3100N Series	1020 mm	915 mm	380 mm

\*At least 130 mm of space is required at the back when replacing the Maintenance Box.

### Notes when using the printer

Note the following points when using this printer to avoid breakdowns, malfunctions, and print quality decline.

- ❑ When using the printer, observe the operating temperature and humidity range described in the "Specifications Table".  
 ↗ "Specifications Table" on page 171  
 Even when the conditions above are met, you may not be able to print properly if the environmental conditions are not suitable for the paper. Be sure to use the printer in an environment where the paper's requirements are met. For more details, see the documentation supplied with the paper. Also, when operating in dry areas, air conditioned environment, or under direct sunlight, maintain the appropriate humidity.
- ❑ Do not install the printer next to heat sources or directly in the path of air from a ventilator or air conditioner. Failure to observe this precaution could result in the print head nozzles drying and clogging.
- ❑ The print head may not be capped (i.e., may not move to the right-hand side) if an error occurs and the printer is turned off without first resolving the error. Capping is a function for automatically covering the print head with a cap (lid) to prevent the print head from drying out. In this case, turn on the power and wait a while until capping is performed automatically.
- ❑ When the power is on, do not remove the power plug or cut the power at the breaker. The print head may not be capped properly. In this case, turn on the power and wait a while until capping is performed automatically.

- ❑ Even when printing is not performed, some of each color of ink will be consumed by ink cartridge replacement, print head cleaning, and other maintenance operations needed to keep the print head in good condition.
- ❑ The printer may automatically perform print head cleaning to maintain good printing quality. Please wait until cleaning finishes without opening any of the covers or turning off the power.

### Notes when not using the printer

If you are not using it, note the following points when storing the printer. If it is not stored correctly, you may not be able to print properly the next time it is used.

- ❑ When storing the printer, store it flat with the ink cartridges installed. Do not place the printer tilted, upright, or upside down.
- ❑ If you do not print for a long time, the print head nozzles may become clogged. We recommend that you print once a week to prevent the print head from clogging.
- ❑ The roller may leave an impression on paper that is left in the printer. This can also cause wavy or curled paper resulting in paper feeding problems or the print head could be scratched. Remove any paper when storing.
- ❑ Store the printer after confirming that the print head has been capped (the print head is positioned at the far right). If the print head is left uncapped for a long time, the print quality may decline.

**Note:**

*If the print head is not capped, turn the printer on, and then turn it off.*

- ❑ To prevent the accumulation of dust and other foreign matter in the printer, close all covers before placing it in storage.  
 If the printer will be not be used for an extended period, protect it with an anti-static cloth or other cover.  
 The print head nozzles are very small, and they can become clogged easily if fine dust gets on the print head, and you may not be able to print properly.

## Introduction

- ❑ The print head may fail if the environmental temperature becomes -10°C or lower. If the environmental temperature in the room or during transport is expected to become -10°C or lower, be sure to discharge the ink in advance.  
🔗 “Handling if Transporting/Leaving the Printer in an Environment of -10°C or Less” on page 167

---

## Notes on handling ink cartridges

Note the following points when handling ink cartridges to maintain good print quality.

- ❑ The ink cartridges packaged with your printer are partly used during initial setup. In order to produce high quality printouts, the print head in your printer will be fully charged with ink. This one-off process consumes a quantity of ink and therefore these cartridges may print fewer pages compared to subsequent ink cartridges.
- ❑ The Initial Cartridge included together with the printer are designed for printer setup and not for resale or later use. After some ink is used for charging, the rest is available for printing. For the initial setup, make sure to use Initial Cartridge.
- ❑ We recommend that ink cartridges be stored at room temperature out of direct sunlight and used before the expiry date printed on the packaging.
- ❑ To ensure good results, use all the ink in the cartridges within 6 months of opening the packages.
- ❑ Do not open the ink cartridge package until you are ready to install it in the printer. The cartridge is vacuum packed to maintain its reliability.
- ❑ Ink cartridges that have been stored at low temperatures for an extended period should be allowed to return to room temperature over a period of at least three hours.
- ❑ Be sure to peel off the tape (yellow) before installing an ink cartridge. If you attempt to forcibly install an ink cartridge without removing the tape, the printer may become unable to print properly. Never peel off anything else such as the film or label. Ink may leak.
- ❑ Do not touch the IC chips on the ink cartridges. You may not be able to print properly.  
🔗 “Replacing Ink Cartridges” on page 135
- ❑ Install the ink cartridges for all the colors. Printing is not possible if they are not all installed.
- ❑ Do not leave the printer without ink cartridges installed. The print head nozzles may dry and printing may become no longer possible.
- ❑ The ink level and other data are stored in the IC chip, allowing cartridges to be used after being removed and replaced. However, if an ink cartridge with not much ink remaining is removed and reinstalled, it may not be usable because some ink is consumed to ensure the reliability of the printer.
- ❑ To avoid getting dust on the ink supply port, store a removed partially used ink cartridge with the ink supply port downward or horizontal in the same environment as this product. The ink supply port has a valve in it so it does not need to be capped.
- ❑ Removed ink cartridges may have ink around the ink supply port, so be careful not to get any ink on the surrounding area when removing the cartridges.
- ❑ To maintain the quality of the print head, this printer stops printing before ink cartridges are completely expended.
- ❑ Although the ink cartridges may contain recycled materials, this does not affect printer function or performance.
- ❑ Do not dismantle or remodel ink cartridges. You may not be able to print properly.
- ❑ Do not drop or otherwise subject an ink cartridge to a strong impact. Ink may leak from the cartridge.
- ❑ Even when the printer is not in use, some of each color of ink will be consumed by ink cartridge replacement, print head cleaning, and other maintenance operations needed to keep the print head in good condition.

## Introduction

- ❑ A mixture of color inks may be used to print black depending on the paper type and print quality settings even for black and white and grayscale printing.

### Notes on handling paper

Note the following points when handling and storing the paper. If the paper is not in good condition, print quality may decline.

Check the documentation supplied with each paper.

### Notes on Handling

- ❑ Use Epson special media under normal room conditions (temperature: 15 to 25°C, humidity: 40 to 60%).
- ❑ Do not fold the paper or scratch the surface of the paper.
- ❑ Avoid touching the printable surface of the paper with your bare hands. Moisture and oils from your hands can affect print quality.
- ❑ Handle paper by the edges. We recommend wearing cotton gloves.
- ❑ Changes in temperature and humidity may cause paper to become wavy or curled. Check the following points.
  - ❑ Load the paper just before printing.
  - ❑ Do not use wavy or curled paper.  
For roll paper, cut off the wavy or curled parts and then load it again.  
For cut sheets, use new paper.
- ❑ Do not wet the paper.
- ❑ Do not throw away the paper packaging as you can use it for storing the paper.
- ❑ Avoid locations that are subject to direct sunlight, excessive heat, or humidity.
- ❑ Keep cut sheets in their original package after opening, and keep them in a flat place.

- ❑ Remove roll paper that is not in use from the printer. Rewind it correctly and then store it in the original packaging that came with the roll paper. If you leave the roll paper in the printer for a long time, its quality may decline.

### Notes on handling printed paper

To maintain long lasting, high quality print results, note the following points.

- ❑ Do not rub or scratch print outs. If they are rubbed or scratched, the ink may peel off.
- ❑ Do not touch the surface of print outs. The ink may peel off.
- ❑ Make sure the print outs are completely dry before folding or stacking; otherwise, the color may change where they touch (leaves a mark). These marks will disappear if they are separated immediately and dried; however, they will remain if not separated.
- ❑ If you put the print outs in an album before they are completely dry, they may be blurred.
- ❑ Do not use a dryer to dry the print outs.
- ❑ Avoid direct sunlight.
- ❑ Prevent color distortion while displaying or storing the print outs by following the instructions in the paper's documentation.

#### Note:

*Typically, print outs and photos fade over time (color distortion) due to the effects of light and various constituents in the air. This also applies to Epson special media. However, with the correct storage method, the degree of color distortion can be minimized.*

- ❑ *See the documentation supplied with Epson special media for detailed information on handling the paper after printing.*
- ❑ *The colors of photos, posters, and other printed materials appear different under different lighting conditions (light sources<sup>\*</sup>). The colors of print outs from this printer may also appear different under different light sources.*  
*\* Light sources include sunlight, fluorescent light, incandescent light, and other types.*

## Introduction

# Saving Power

The printer enters sleep mode or turns off automatically if no operations are performed for a set period. You can adjust the time before power management is applied. Any increase will affect the product's energy efficiency. Please consider the environment before making any change.

### Sleep mode

The printer enters sleep mode when there are no errors, no print jobs being received, and no control panel or other operations performed. When the printer enters sleep mode, the control panel's screen turns off and the internal motors and other parts switch off to consume less power.

Sleep mode is exited if a print job is received or the screen of the control panel is touched.

The delay before the printer enters sleep mode can be selected from values between 1 and 210 minutes. At default settings, the printer enters sleep mode if no operations are performed for 15 minutes. The delay can be changed from the **Basic Settings** menu.

 [“General Settings - Basic Settings” on page 115](#)

#### **Note:**

*When the printer enters sleep mode, the control panel's screen goes blank as if the power has been turned off, but the  light remains lit.*

### Power Off Timer

This function automatically turns the printer off if no errors occur, no print jobs are received, and no control panel or other operations are performed for a set period of time.

The default setting differs as follows depending on the model.

- SC-T5100/SC-T5100N/SC-T5180/SC-T5180N/  
SC-T3100/SC-T3100N/SC-T3180N  
Set to **8h**.
- SC-T5130/SC-T5160/SC-T5160N/SC-T3130/  
SC-T3130N/SC-T3160/SC-T3160N  
Set to **Off**.

Power Off Timer settings can be changed from the Basic Settings menu.

 [“General Settings - Basic Settings” on page 115](#)

## Introducing the Software

# Introducing the Software

## Provided Software

The following table lists the provided software.



The supplied software disc contains the software for Windows. When using a Mac or a computer without a disc drive, download the software from <http://epson.sn> and then install it.

For details on the various software, see the online help of each software or the *Administrator's Guide* (online manual).

**Note:**

Convenient software compatible with this printer is introduced on the Epson website. Please check the information from the following link.

<http://www.epson.com>

Software Name	Function
Printer Driver	Install the printer driver to take full advantage of the functionality of this printer when printing.  <a href="#">"Printing with the Printer Driver from Your Computer" on page 46</a>
EPSON Software Updater	Software to check whether there is any software update information and then notify you and install the software if an update is available. It allows you to update the firmware and already installed software of the printer.  <a href="#">"Updating Software or Installing Additional Software" on page 25</a>
LFP Print Plug-In for Office (Windows Only)	Plug-in software for Microsoft Office applications (Word, Excel, and PowerPoint). Installing this plug-in displays ribbon items in Office applications that give quick access to horizontal and vertical banner printing and enlarged printing. It can be installed by selecting it in the Additional Installation screen when installing the software. You can also install it later with EPSON Software Updater. The supported Microsoft versions are shown below. Office 2003/Office 2007/Office 2010/Office 2013/Office 2016
EpsonNet Config	Software to configure the initial settings of the network or change the settings of the network in bulk when installing or relocating Epson printers and scanners. EpsonNet Config is not installed automatically. Download it from the Epson website and then install it if necessary. <a href="http://www.epson.com">http://www.epson.com</a> For Windows, you can install the software from the following folder on the supplied software disc. \\Network\EpsonNetConfig  <i>Administrator's Guide</i>

## Introducing the Software

# Built-in Software in the Printer

The following software comes preinstalled in the printer. Start and use it from a Web browser via the network.

Software Name	Function
Web Config	The network security settings can be configured from Web Config. This software also has an email notification function for notifying of printer errors and other problems. <a href="#">👉 "How to Use Web Config" on page 24</a>

## Introducing the Software

# How to Use Web Config

This section describes how to start the software and provides a summary of its functions.

## How to Start

Start the software from a web browser on a computer or smart device that is connected to the same network as the printer.

- 1 Check the IP address of the printer.

Touch  on the Home screen, select the connected network, and check the IP address.

**Note:**

The IP address can also be checked by printing a network connection check report. A report can be printed by touching the following in order from the Home screen.

**Settings - General Settings - Network Settings - Connection Check**

- 2 Start a Web browser on a computer or smart device connected to the printer via the network.

- 3 Enter the IP address of the printer in the address bar of the Web browser and press the **Enter** or **Return** key.

Format:

IPv4: http://IP address of printer/

IPv6: http://[IP address of printer]/

Example:

IPv4: http://192.168.100.201/

IPv6: http://[2001:db8::1000:1]/

## Closing

Close the Web browser.

## Function Summary

This section introduces the main functions of Web Config. For more details, see the *Administrator's Guide*.



## Main Functions

- Check the printer's status, such as the remaining amount of ink.
- Check and update the printer's firmware version.
- Configure the printer's network settings and advanced security settings, such as SSL/TLS communication, IPsec/IP filtering, and IEEE802.1X, which cannot be configured with the printer alone.
- Edit the custom paper settings and export and import the settings.  
The custom paper settings registered in **Settings - General Settings - Printer Settings - Custom Paper Setting** of the printer can be changed as well as exported to a file and then imported (registered) to another printer. This is convenient when you install multiple printers and want to use common custom paper settings for them.



## Introducing the Software

# Updating Software or Installing Additional Software

When you install the software during setup as described in the *Setup Guide*, Epson Software Updater is installed. Epson Software Updater allows you to update the firmware and already installed software in your computer as well as install additional software compatible with the printer.

**Note:**

The software is updated as needed for greater convenience and more robust functionality. We recommend setting to receive update notifications with Epson Software Updater and updating the software as soon as possible when there is a notification.

## Checking Whether Updates Available and Updating Software

**1** Check that the computer and printer are in the following states.

- Computer is connected to the Internet.
- Printer and computer can communicate.

**2** Start Epson Software Updater.

- Windows  
Display the list of all the programs and then click Epson Software Updater in the Epson Software folder.

**Note:**

- If you press the Windows key (key with Windows logo mark) on the keyboard and then type the software name in the search box of the displayed window, the software appears immediately.
- The software can also be started by clicking the printer icon on the Taskbar of the desktop and then selecting **Software Update**.

- Mac  
Select **Go - Applications - Epson Software - EPSON Software Updater**.

**3** Select the software or manuals to be updated and then update them.

Follow the on-screen instructions.

 **Important:**

Do not turn off the computer or printer during the update.

**Note:**

Software not displayed in the list cannot be updated with Epson Software Updater. Check the latest versions of software on the Epson website.

Please note that you cannot update or install software using Epson Software Updater if you are using a Windows Server OS. Download the software from the Epson website.

<http://www.epson.com>

## Receiving Update Notifications

### Windows

- 1** Start Epson Software Updater.
- 2** Click **Auto update settings**.
- 3** Select the interval to perform the update check in the **Interval to Check** field of the printer and then click **OK**.

### Mac

The software is set by default to check and notify whether there are updates every 30 days.

Introducing the Software

# Uninstalling Software

## Windows

**Important:**

- ❑ You must log in as an Administrator.
- ❑ If the password or confirmation of an administrator is requested, enter the password and then continue with the operation.

- 1 Turn off the printer, and unplug the interface cable.
- 2 Close all applications running on your computer.
- 3 Go to the **Control Panel** and click **Uninstall a program** from the **Programs** category.



- 4 Select the software you want to remove and then click **Uninstall/Change** (or **Change/Remove / Add/Remove**).

You can remove the printer driver and EPSON Status Monitor 3 by selecting **EPSON SC-XXXXX Printer Uninstall**.

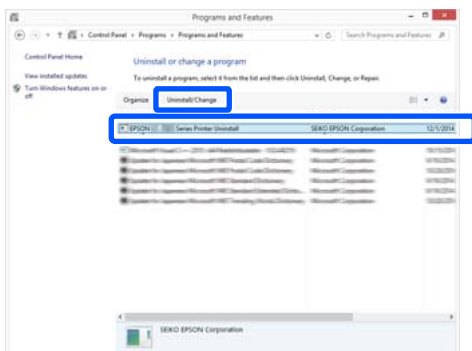

- 5 Select the printer icon, and then click **OK**.



- 6 Follow the on-screen instructions to continue. When the delete confirmation message appears, click **Yes**.

Restart the computer if you are reinstalling the printer driver.

## Mac

When reinstalling or upgrading the printer driver or other software, follow the steps below to uninstall the target software first.

### Printer Driver

Use the "Uninstaller".

### Downloading the Uninstaller

Download Uninstaller from the Epson website.

<http://www.epson.com/>

### Using the Uninstaller

Follow the instructions on the Epson website.

### Other Software

Drag and drop folder with the software name from the **Applications** folder into **Trash** to delete.

## Loading and Setting the Paper

# Loading and Setting the Paper

## Notes on Loading the Paper



### Caution:

Do not rub the edges of the paper with your hands. The edges of the paper are thin and sharp and could cause an injury.

### Do not leave paper loaded in the printer

The roller may leave an impression on paper that is left in the printer. In addition, the paper may become wavy or curled due to damp, which may cause paper feeding problems, paper jams, or soiled prints.

We recommend that you return the paper to its original package and store it flat, and take it out of the package for use when printing.

### Do not load roll paper with the right and left edges uneven

Loading roll paper with the right and left edges uneven may cause paper feeding problems or paper meandering may occur during printing. Rewind the paper to make the edges even, or use roll paper with no problem.

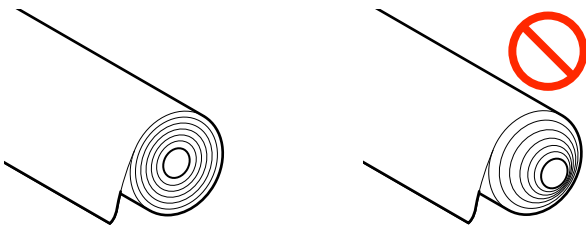

### Do not load curled paper

Loading curled paper may cause paper jams or soiled prints. Flatten the paper before use by bending it in the opposite way or use paper with no problem.

### Unsupported paper

Do not use paper that is wavy, torn, cut, folded, too thick, too thin, has a sticker affixed, etc. Doing so may cause paper jams or soiled prints. See the following for paper supported by the printer.

 [“Epson Special Media Table” on page 157](#)

 [“Supported Commercially Available Paper” on page 160](#)

## Paper Load Position

The position to load paper differs depending on the shape and size of the paper to be loaded. See the following for more details on the paper that can be used with the printer.

 [“Supported Media” on page 157](#)

### Roll Paper

Roll paper from 329 mm to the maximum printable width can be loaded.

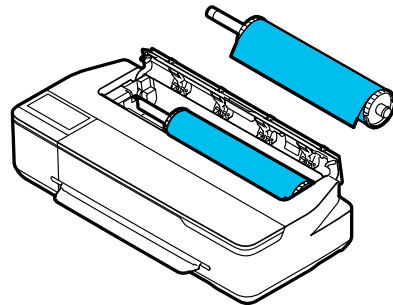

### Auto Sheet Feeder

Multiple sheets of A3 to A4 paper can be loaded. The number of sheets that can be loaded at once differs depending on the paper. See the following for more details.

 [“Cut Sheet” on page 158](#)

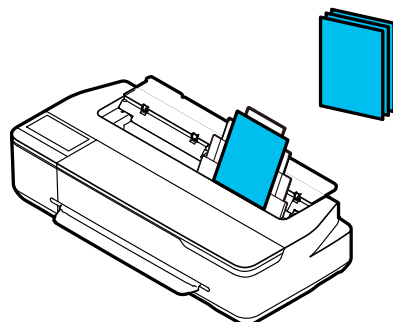

## Loading and Setting the Paper

### Cut Sheet(1 sheet)

One sheet of cut paper from A4 to the maximum printable width can be loaded.

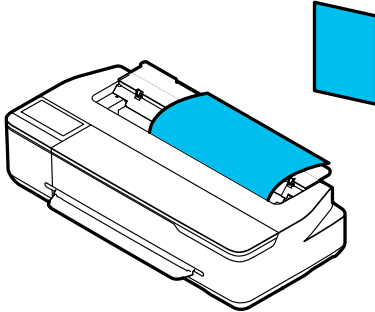

**Note:**

- ❑ The paper slot for Roll Paper and Cut Sheet(1 sheet) is the same. Insert either one into the paper slot.
- ❑ Paper can be loaded in the auto sheet feeder while leaving roll paper loaded. You can switch to one of the paper sources in the printer driver.

## Loading and Removing the Roll Paper

Place the roll paper on the supplied spindle and then load the roll paper in the printer.

When replacing paper, remove the loaded paper first.

[“Removing Roll Paper” on page 32](#)

[“Removing Cut Sheet \(1 Sheet\)” on page 38](#)

When paper is loaded in the auto sheet feeder, remove it and then load it again after you finish loading or removing the roll paper. Before printing on roll paper, remove the stacker.

[“Removing Paper from the Auto Sheet Feeder” on page 36](#)

[“Attaching and Removing the Stacker \(for Plain Paper\)” on page 34](#)

## Loading Roll Paper

**Caution:**

Make sure to grip the flanges of the spindle when loading a roll paper. If you hold and load the roll paper by gripping the other parts, your hand or finger may get injured.

**Note:**

You can load the paper while viewing the loading procedure on the screen. To view the procedure on the screen, touch the Roll paper information area of the Home screen.

- 1 Check that "Load paper." is displayed on the Home screen and then open the cut sheet cover.

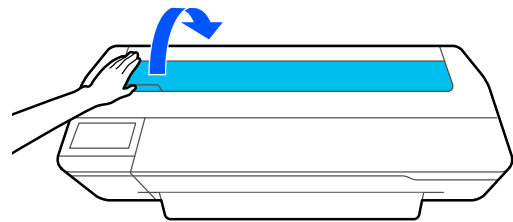

- 2 Release the central lock, and then open the roll paper cover.

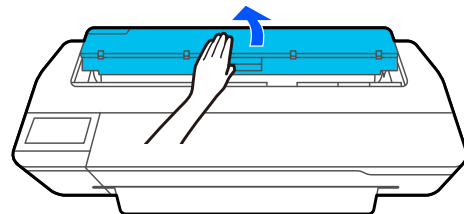

- 3 Remove the inserted spindle.

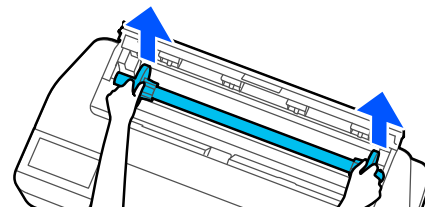

- 4 Pull off the transparent flange from the spindle.

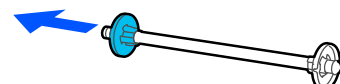

### Loading and Setting the Paper

- 5** Place the roll paper on a flat surface and then insert the spindle.
- With the black flange is on the right, orient the roll paper so that the leading edge is as shown in the figure below.

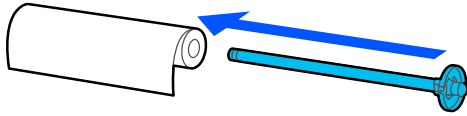

- 6** Push the flange to the roll paper until there is no gap between the flange and roll paper.

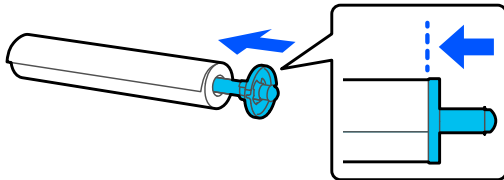

- 7** Attach the transparent flange and push it until there is no gap between the flange and roll paper.

If there are gaps between the flanges at both ends and the roll paper, the paper may be fed skewed resulting in an error.

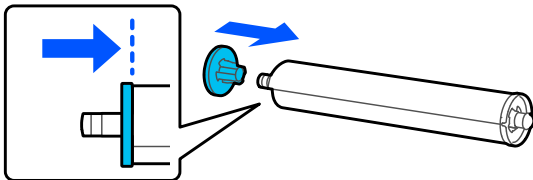

- 8** Orient the paper roll so that the black flange of the spindle is on the right side and then insert the spindle shafts into the cavities in the left and right of the spindle holder.

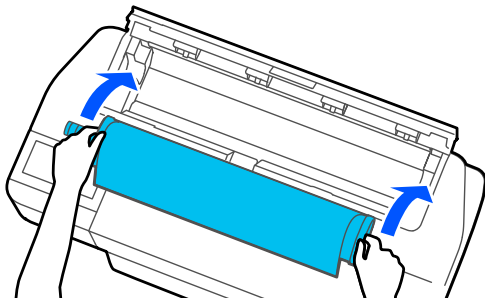

- 9** Check that the leading edge of the roll paper is not bent and then insert it into the paper slot until you hear a beep.

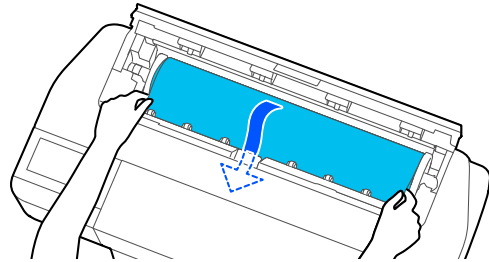

**!** **Important:**

*Hold the paper edges and insert the paper straight into the paper slot. Inserting it skewed will cause a skew error or paper jam.*

**Note:**

*If the leading edge of the roll paper is not horizontal or not cut cleanly, it will be cut automatically after loading completes. However, it will not be cut if **Auto Cut** is set to **Off**.*

- 10** Close the roll paper cover and cut sheet cover.

- 11** On the displayed screen, set the paper type that matches the loaded paper and set remaining amount management if necessary.

Not setting the appropriate paper type will cause print quality trouble. See the following for more details on the paper types and remaining amount settings.

 [“For Roll Paper” on page 39](#)

## Loading and Setting the Paper

**! Important:**

**When paper equivalent to B1 width is loaded in SC-T5100 Series/SC-T5100N Series**

Raise the B1 width paper support as shown in the figure only when you have loaded B1 width (718 to 738 mm) paper. If you do not raise the B1 width paper support, the print surface may be scuffed or soiled.

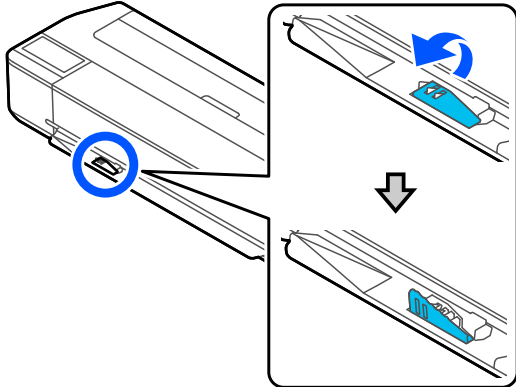

Leave the support lowered when printing to a size other than equivalent to B1 width.

**12**

For SC-T5100 Series and SC-T3100 Series, check that the paper basket attached to the stand is open.

**Note:**

Close the paper basket before printing banners or other documents of sizes that will not fit in the paper basket. Before the paper ejected from the printer touches the floor, we suggest that you take it in both hands close to the paper eject slot and continue to lightly support it until printing is complete.

- When printing of one page is finished  
The roll paper is cut before printing of the next page starts.

If you do not want to cut each page or you want to cut at a desired position, see the following procedure.

### Cutting after Last Page Printed or at Desired Position

Turn off auto cut in the printer driver, print, and then cut using the **Feed/Cut Paper** menu of the printer after printing finishes.

**1**

Select **Off** in **Advanced - Roll Paper Option - Auto Cut** of the printer driver and then print.

Leave the auto cut setting of the printer on.

**Note:**

- The auto cut setting of the printer driver has priority over that of the printer. The auto cut setting of the printer driver is reset to the default setting of **Normal Cut** when the application closes.
- To turn off auto cut when HP-GL/2 mode printing or enlarged copying, turn off the auto cut setting of the printer. Touch the Roll paper information area - **Advanced Media Setting - Auto Cut - Off** from the Home screen. The change to the setting is saved as a setting of the currently selected paper type.

**2**

Touch the Roll paper information area - **Feed/Cut Paper** from the Home screen of the printer after printing finishes.

Use the buttons displayed on the screen to cut and feed the paper.

**When cutting at the printer default cut position (right after the bottom margin)**

Touch the ✂ (Cut) button. The paper is cut and the paper leading edge returns to the print wait position.

## Cutting the Roll Paper



### Auto Cut

Auto Cut is set to On for the printer by default. When On is set, the roll paper is cut automatically at the following times.

- When the leading edge is detected as not horizontal  
After the roll paper is loaded, the leading edge part is cut straight.

## Loading and Setting the Paper

### When cutting at desired position

- ① Touch and hold down the  (Forward) or  (Backward) button until the position you want to cut comes to the position of the dotted line in the figure.

A cut position cannot be set further inside than the bottom margin.

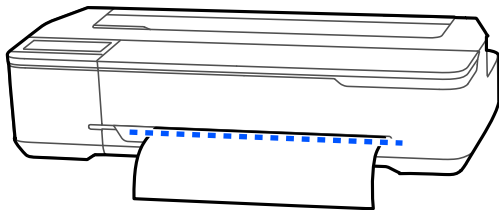

- ② Touch the  (Cut) button.

The paper is cut.

#### Note:

When the length of **A** in the figure is shorter than the following length, the paper is fed automatically until the required length is obtained at the time of cutting.

- Plain paper or tracing paper: 100 mm
- Photo paper or coated paper: 80 mm
- Synthetic paper and other thick paper: 60 mm

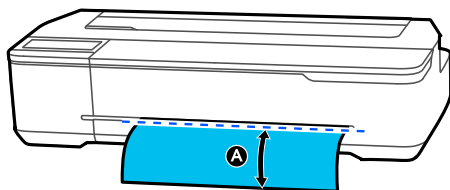

### Cutting Commercially Available Synthetic or Canvas Paper with Scissors

When using commercially available paper that cannot be cleanly cut with the cutter of the printer, print cut lines and cut the paper with scissors.

#### Important:

- If commercially available synthetic or canvas paper is cut with the built-in cutter, the cutter may be damaged or its life may be shortened. When using such paper, cut the paper with scissors as described in the following procedure.
- Do not use a cutter. The printer may be damaged.

- 1 Turn off the auto cut setting and then print.  
To print cut lines, turn off the auto cut setting of the printer. When printing via the printer driver, also turn off the setting of the printer driver.



- Printer settings  
Roll paper information area - **Advanced Media Setting - Auto Cut - Off** from the Home screen.
- Printer driver settings  
**Advanced - Roll Paper Option - Auto Cut - Off**

- 2 Touch the Roll paper information area - **Feed/Cut Paper** from the Home screen of the printer after printing finishes.

- 3 Operate the buttons displayed on the screen.  
**When printing cut lines at the printer default position (right after the bottom margin)**

Touch the  (Cut) button. The cut or print cut lines selection screen appears.

#### When printing cut lines at desired position

Touch and hold down the  (Forward) or  (Backward) button until the position you want to print the cut lines comes to the position of the dotted line in the figure.

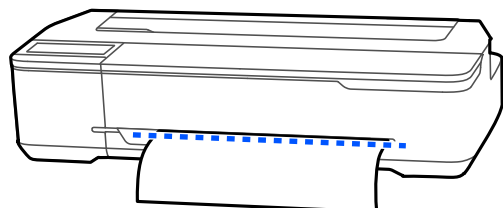



## Loading and Setting the Paper

Cut lines cannot be printed further inside than the bottom margin. Once you have finished moving the paper, touch  (Cut). The cut or print cut lines selection screen appears.

### 4 Touch **Print Cutting Guideline**.

Cut lines are printed and the paper is ejected automatically to a position where it can be easily cut with scissors.

### 5 Cut the paper along the cut lines with scissors and then touch **Done**.

The paper rewinds to return the paper leading edge to the print wait position.

## Removing Roll Paper

This section describes how to remove and store roll paper after printing. The rollers may leave impressions on roll paper if you leave the paper loaded in the printer.

**Note:**

You can remove the paper while viewing the procedure on the screen. To view the procedure on the screen, touch the Roll paper information area - **Remove** from the Home screen.

### 1 When the trailing edge of printed paper is held in the printer, pull out the paper toward you by holding both edges of the paper with your hands.

The printed paper will drop out automatically if the next printing is started.

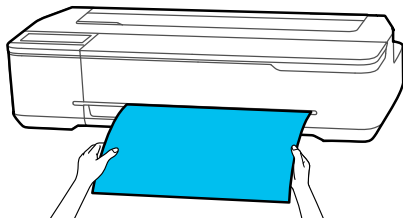

### 2 Open the cut sheet cover.

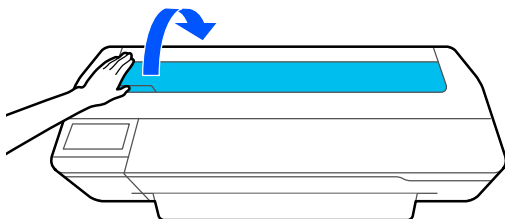

### 3 Release the central lock, and then open the roll paper cover.

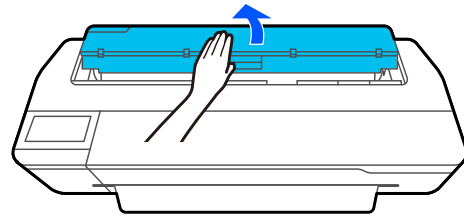

### 4 Touch **Remove**.

The paper is rewound and ejected.

**Note:**

If printed paper is not cut and remains, a confirmation screen appears.

Touch **Cut** to cut the paper at the default cut position or touch **Print Cutting Guideline** to print cut lines at the default position.

If you want to change the cut position or cut lines print position to desired position, touch **Close** and change the position in the **Feed/Cut Paper** menu.

See the following for more details.

 ["Cutting the Roll Paper" on page 30](#)

### 5 Hold the flanges on both ends of the spindle and remove the spindle from the spindle holder.

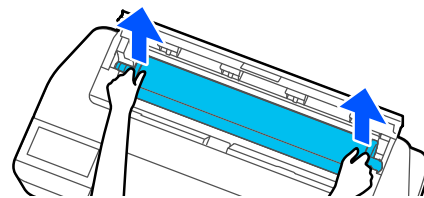

### 6 Detach the transparent flange from the spindle.

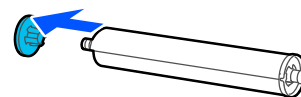

### 7 Remove the spindle from the roll paper.

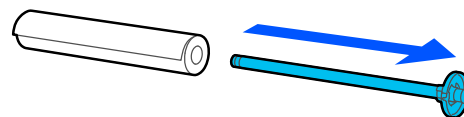



## Loading and Setting the Paper

**!** **Important:**

*After rewinding the roll paper carefully, store it in the original package.*

- 8** Attach the transparent flange to the spindle and return the spindle in the printer.

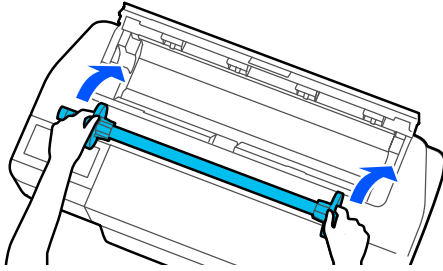

- 9** Close the roll paper cover and cut sheet cover.

**Loading and Setting the Paper**

# Loading and Removing Paper in/from the Auto Sheet Feeder

## Attaching and Removing the Stacker (for Plain Paper)

Attach the supplied stacker before continuously printing multiple sheets of plain paper from the auto sheet feeder. The number of sheets that can be ejected to the stacker is approximately 20.

However, when printing on roll paper or cut sheet (1 sheet), remove the stacker so that the paper can be ejected smoothly.

**How to attach**

Attach the stacker by inserting the hooks of the stacker straight into the holes in the front of the printer.

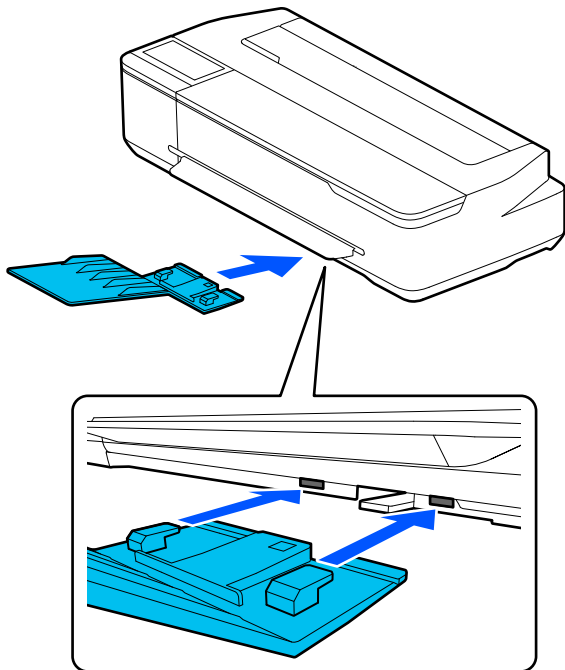

**How to remove**

Remove the stacker by pulling it toward you.

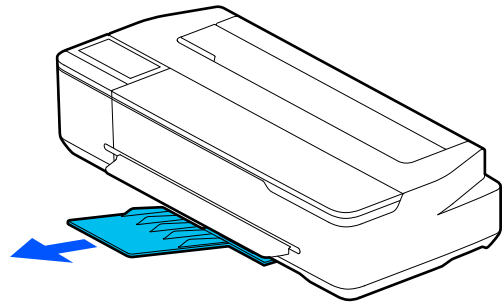

## Loading Paper in the Auto Sheet Feeder

**Note:**

- ❑ The number of sheets that can be loaded in the auto sheet feeder differs depending on the paper. See the following for more details.
  - 👉 "Cut Sheet" on page 158
  - 👉 "Supported Commercially Available Paper" on page 160
- ❑ You can load the paper while viewing the procedure on the screen. To view the procedure on the screen, touch **Paper Setting - Auto Sheet Feeder** from the Home screen.

- 1** Check that "Load paper." or "Ready" is displayed on the Home screen and then open the cut sheet cover.

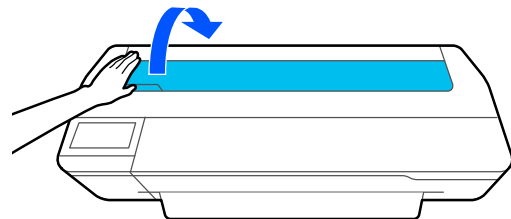

### Loading and Setting the Paper

- 2** Tilt the auto sheet feeder toward the back and then pull it out upward.

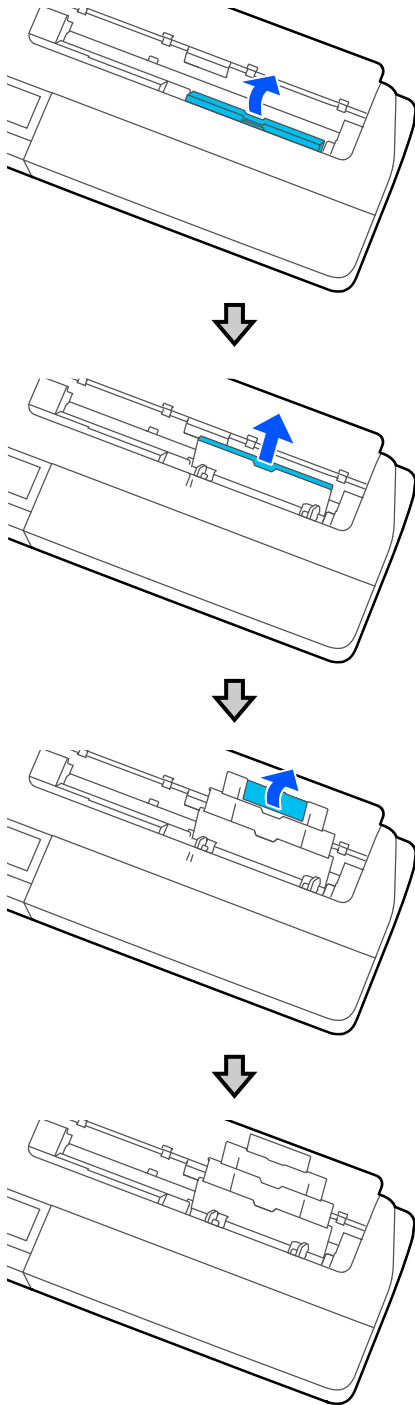

- 3** Load sheets of paper with the print side facing up in the auto sheet feeder.

Align the paper edges and then load the paper.

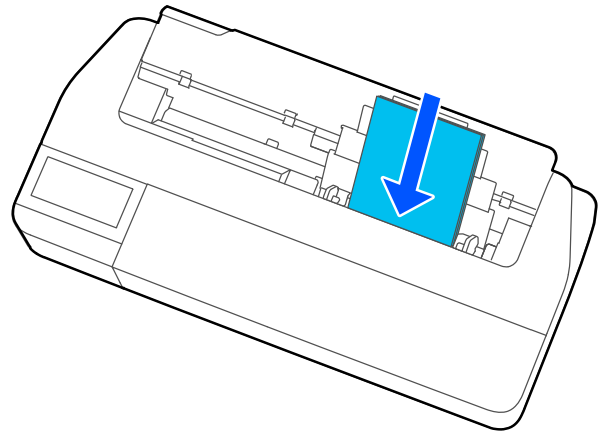

**!** **Important:**

*Insert all paper in portrait orientation. Inserting paper in landscape orientation may cause a decline in print quality.*

- 4** Slide the edge guides against the edges of the paper.

If the edge guides are positioned away from the paper edges, the paper could be fed skewed, which may cause a skew error or paper jam.

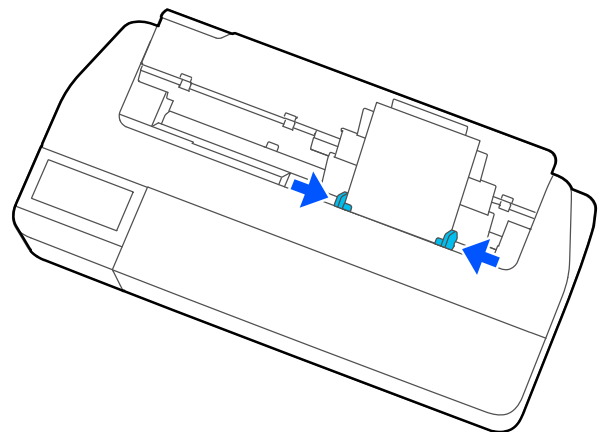

- 5** On the displayed screen, set the paper type and size that match the loaded paper.

Not setting the appropriate paper type will cause print quality trouble. See the following for more details on the paper types and sizes.

[☞](#) “For Auto Sheet Feeder / Cut Sheet(1 sheet)” on page 41

## Loading and Setting the Paper

### Removing Paper from the Auto Sheet Feeder

- 1 Widen the edge guides and then remove the paper.

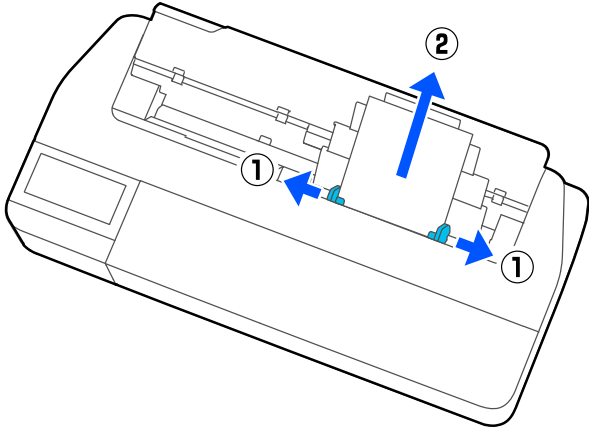

- 2 Fold down the auto sheet feeder and then tilt it to the front.

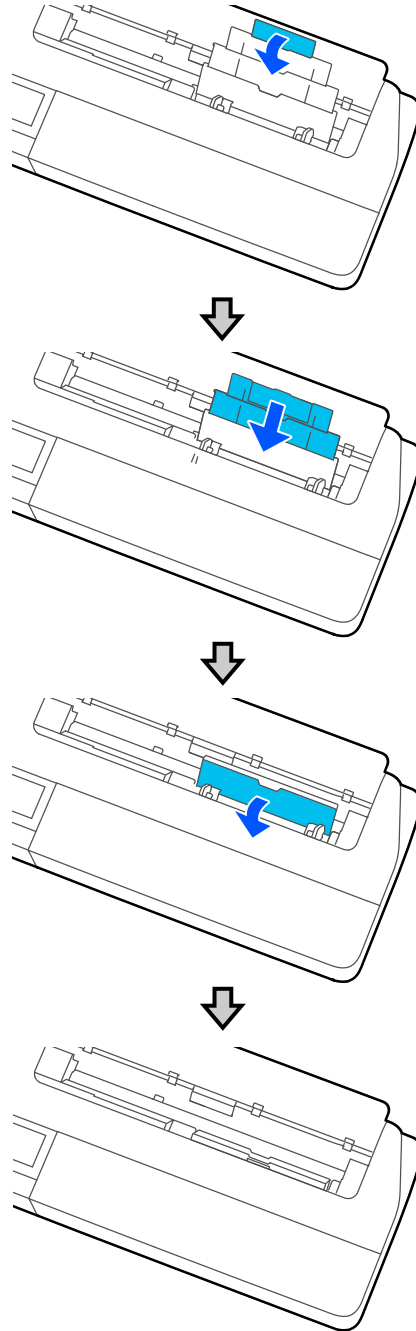

- 3 Close the cut sheet cover.

## Loading and Setting the Paper

# Loading and Removing Cut Sheet(1 sheet)

## Loading Cut Sheet(1 sheet)

When roll paper is loaded, remove it.

 [“Removing Roll Paper” on page 32](#)

When paper is loaded in the auto sheet feeder, remove it and then fold down the auto sheet feeder. Also, if the stacker is attached, remove it.

 [“Removing Paper from the Auto Sheet Feeder” on page 36](#)

 [“Attaching and Removing the Stacker \(for Plain Paper\)” on page 34](#)

**1** Check that **"Load paper."** is displayed on the Home screen and then touch **Paper Setting - Cut Sheet(1 sheet)**.

**2** Open the cut sheet cover.

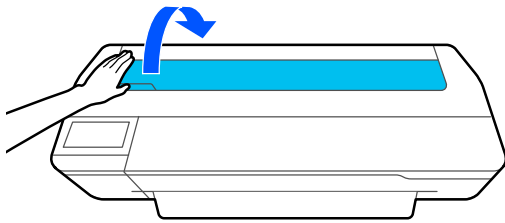

**3** Load a sheet of paper with the print side facing up, and then align its right edge with the mark line on the right and its left edge with the mark line for the paper size.

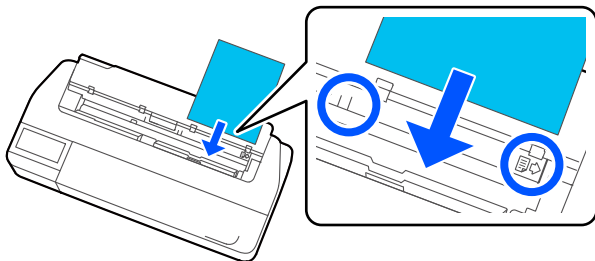

### **Important:**

*Insert all paper in portrait orientation. Inserting paper in landscape orientation may cause a decline in print quality.*

**4** Insert the leading edge of the paper straight into the paper slot until you hear a beep.

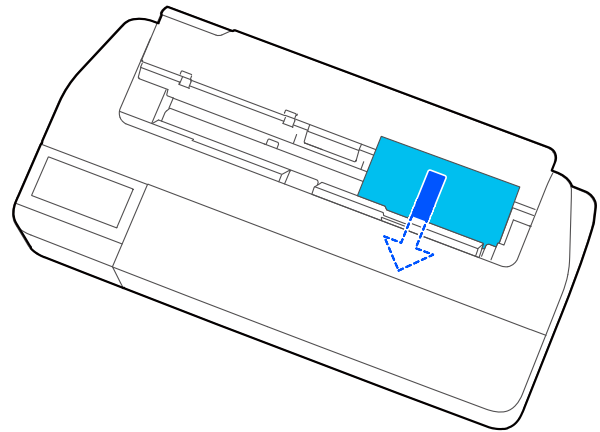

### **Important:**

*Hold the paper edges and insert the paper straight into the paper slot. Inserting it skewed will cause a skew error or paper jam.*

**5** On the displayed screen, set the paper type and size that match the loaded paper.

Not setting the appropriate paper type will cause print quality trouble. See the following for more details on the paper types and sizes.

 [“For Auto Sheet Feeder / Cut Sheet\(1 sheet\)” on page 41](#)

## Loading and Setting the Paper

**! Important:**

**When B1 size paper is loaded in SC-T5100 Series/SC-T5100N Series**

Raise the B1 width paper support as shown in the figure only when you have loaded B1 width (718 to 738 mm) paper. If you do not raise the B1 width paper support, the print surface may be scuffed or soiled.

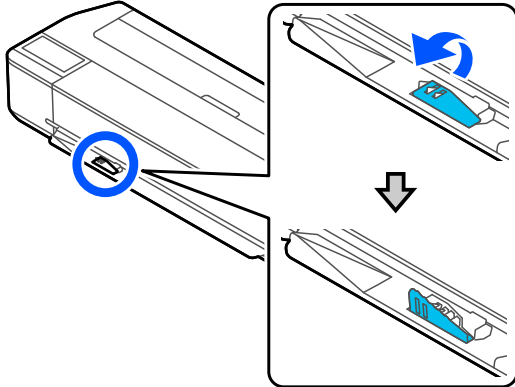

Leave the support lowered when printing to a size other than equivalent to B1 width.

The trailing edge of the paper stops in the state in which is held in the printer after printing. The paper will drop out automatically if the next printing is started before it is removed by hand.

- 6** For SC-T5100 Series and SC-T3100 Series, check that the paper basket attached to the stand is open.

## Removing Cut Sheet (1 Sheet)

### When Removing Unprinted Cut Sheet

Touch **Paper Setting - Cut Sheet(1 sheet) - Remove** from the Home screen.

The paper is ejected.

### When Removing Printed Cut Paper

Pull out the paper toward you by holding the edges of the paper with your hands.

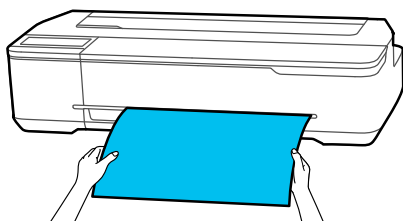

## Loading and Setting the Paper

# Setting Loaded Paper

## For Roll Paper

Configure the following settings after loading roll paper.

### Paper Type Settings

This is the most important setting to obtain the optimum print results. Not setting a paper type that matches the loaded paper will cause wrinkles, scuffing, uneven colors, and other trouble.

### Manage Remaining Amount Settings

If you enable the Manage Remaining Amount setting and then enter the total length of the loaded roll paper, an estimate of the remaining amount of roll paper will be displayed on the Home screen of the printer and on the screen of the printer driver. Furthermore, a notification can also be displayed when the remaining amount has become low.

The remaining amount values are saved associated with the paper types. This enables, for example, the remaining amount to be managed separately for plain paper and tracing paper.

**Note:**

If you want to use remaining amount management with two roll paper of the same paper type but different widths, register the width of one of them in Custom Paper Setting. Custom Paper Setting registration adds a new paper type setting. Perform the registration in **Settings - General Settings - Printer Settings - Custom Paper Setting**. For details on Custom Paper Setting, see the following Custom Paper Setting menu.

 [“General Settings - Printer Settings” on page 117](#)

## How to Set

1

The currently set paper type is shown on the screen displayed after loading roll paper.

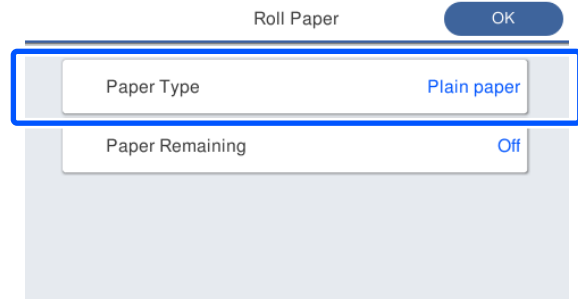

### When changing Paper Type

Proceed to step 2.

### When setting Paper Remaining without changing Paper Type

Proceed to step 5.

### When not changing either of them

Touch **OK**. You can start printing once **Ready** appears on the screen.

**Note:**

The settings are confirmed if no operations are performed for 90 seconds on the above screen. To change the settings later, touch the Roll paper information area - **Change Paper Type** from the Home screen and then configure the settings.

2

Touch **Paper Type**.

The following paper type selection screen appears.

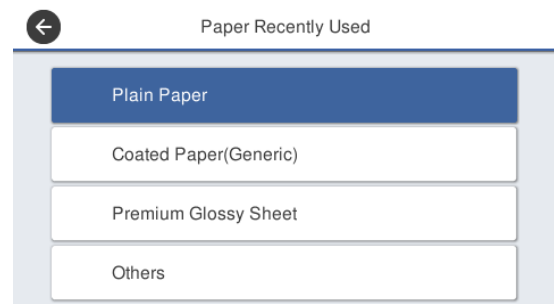

**Note:**

The most recently selected three paper types are displayed in addition to **Others**.

### Loading and Setting the Paper

**3** Select the paper type that matches the loaded roll paper.

#### Epson Special Media

Select the same product name as the one shown on the package of the paper.

#### Commercially available non-Epson paper

Select from the following commercially available paper types.

- Plain paper
- Coated Paper(Generic)
- Photo Paper(Generic)
- Tracing Paper
- Tracing Paper <LowDuty>
- Matte Film

To select a paper type that is not displayed on the screen, touch **Others**.

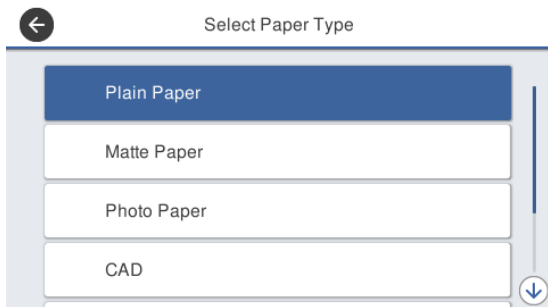

Select a category and select the target paper type.

**Note:**  
If you scroll downward in the category selection screen, **Custom Paper** appears. To select custom paper that has already been registered, touch **Custom Paper**.

**4** When a paper type is selected, the screen returns to the one in step 1.

If you will not set the remaining amount management setting, touch **OK**.

**5** Touch **Paper Remaining**.

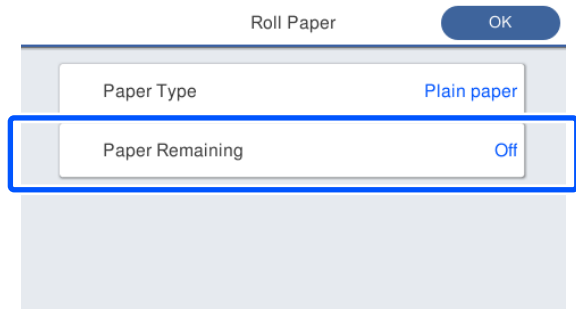

**6** Touch **Setup**.

The setting changes to **On**, and **Remaining Amount** and **Remaining Alert** are enabled. Touch each one and enter a value as follows.

- Remaining Amount: Total length of roll paper (see the manual supplied with the roll paper)
- Remaining Alert: Remaining amount value that will be the timing for displaying the remaining amount warning notification.

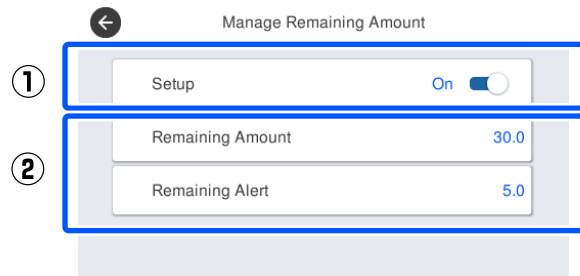

**Note:**  
On the keypad screen for entering a numeric value, enter numbers that include a number of the first decimal place. For example, if you want to enter 5 m, touch [5] and [0].

**7** Touch **←** at the top left of the screen to return to the screen of step 5 and then touch **OK**.

You can start printing once **Ready** appears on the screen.

**Note:**  
If you replace the paper after the remaining amount indication has become 0 m or the paper has actually run out, **Remaining Amount** returns to the default setting value of 30 m.



## Loading and Setting the Paper

### For Auto Sheet Feeder / Cut Sheet(1 sheet)

Configure the following settings after loading paper in the Auto Sheet Feeder or loading Cut Sheet(1 sheet).

#### Paper Type Settings

This is the most important setting to obtain the optimum print results. Not setting a paper type that matches the loaded paper will cause wrinkles, scuffing, uneven colors, and other trouble.

#### Paper Size Setting

The paper size of paper loaded in the auto sheet feeder or loaded Cut Sheet(1 sheet) is not detected automatically. Set the size of the loaded paper.

### How to Set

- 1 The currently set paper type is shown on the screen displayed after loading cut sheet.

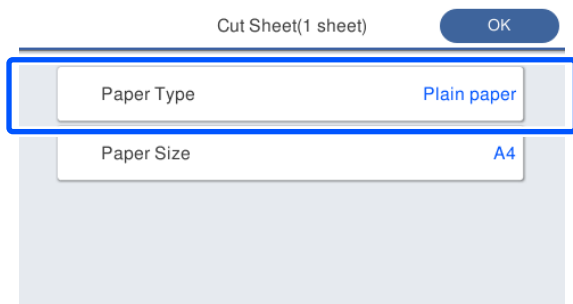

#### When changing Paper Type

Proceed to step 2.

#### When changing Paper Size without changing Paper Type

Proceed to step 4.

#### When not changing either of them

Touch **OK**. You can start printing once **Ready** appears on the screen.

#### Note:

The settings are confirmed if no operations are performed for 90 seconds on the above screen. To change the settings later, touch the following in order from the Home screen and then configure the settings.

- Auto Sheet Feeder  
**Paper Setting - Auto Sheet Feeder - Change Paper Type/Paper Size**
- Cut Sheet(1 sheet)  
**Paper Setting - Cut Sheet(1 sheet) - Change Paper Type/Paper Size**

- 2 Touch **Paper Type**.

The following paper type selection screen appears.

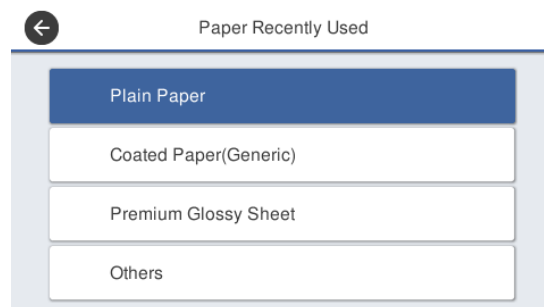

#### Note:

The most recently selected three paper types are displayed in addition to **Others**.

- 3 Select the paper type that matches the loaded paper.

#### Epson Special Media

Select the same product name as the one shown on the package of the paper.

#### Commercially available non-Epson paper

Select from the following commercially available paper types.

- Plain paper
- Coated Paper(Generic)
- Photo Paper(Generic)
- Tracing Paper
- Tracing Paper <LowDuty>
- Matte Film

## Loading and Setting the Paper

To select a paper type that is not displayed on the screen, touch **Others**.

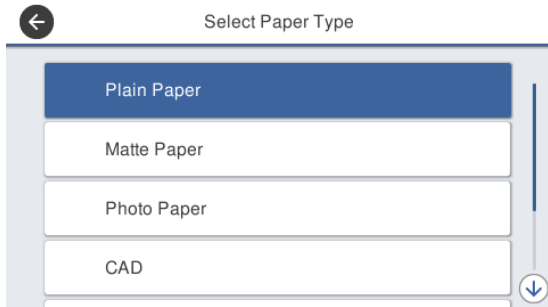

Select a category and select the target paper type. When a paper type is confirmed, the screen returns to the one in step 1.

**Note:**

If you scroll downward in the category selection screen, **Custom Paper** appears. To select custom paper that has already been registered, touch **Custom Paper**.

### 4 Touch Paper Size.

If you will not change the paper size, touch **OK**.

#### Auto Sheet Feeder

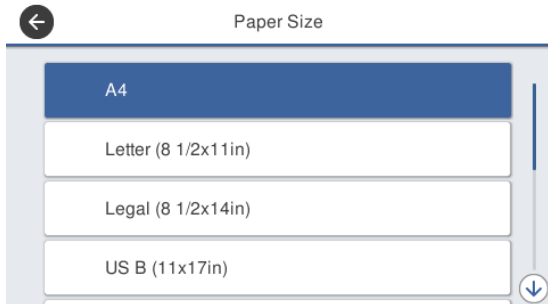

#### Cut Sheet(1 sheet)

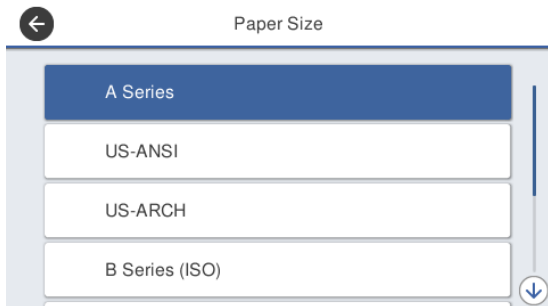

Select a category and select the target paper size.

**Note:**

**Setting non-standard size**

For a non-standard size, touch **User-Defined** at the end of the list and then enter the paper width and length.

On the keypad screen for entering a numeric value, enter numbers that include a number of the first decimal place. For example, if you want to enter 5 m, touch [5] and [0].

### 5

When the screen of step 1 is redisplayed, touch **OK**.

You can start printing once **Ready** appears on the screen.

## Loading and Setting the Paper

# Optimizing Paper Settings (Media Adjust)

Perform Media Adjust in the following cases. It allows you to adjust the settings to perform printing appropriately with the paper to be used easily in wizard format.

- When there are streaks in print results or ruled lines are duplicated or text is blurred
- When registered with custom paper settings

The adjustment results are stored until the next time adjustment is performed. After adjustment is complete, you will be able to perform printing appropriately by simply selecting that paper type.

**Note:**

**Adjustment for paper registered with custom paper settings**

*With roll paper and cut sheet, the paper settings for optimal printing differ even when the paper type is exactly the same. When using both roll paper and cut sheet of the same paper type, register custom paper separately and also make the adjustments separately.*

*Custom Paper Setting registration adds a new paper type setting. Perform the registration in **Settings - General Settings - Printer Settings - Custom Paper Setting**.*

*For details on Custom Paper Setting, see the following Custom Paper Setting menu.*

*[☞ "General Settings - Printer Settings" on page 117](#)*

## Notes on Making Adjustments

- Correctly load the paper that actually requires adjustment and then select the paper type that matches the loaded paper.
- If paper with visible curls, wrinkles, waves, folds, or bends is used, correct adjustment may not be possible. Remove curled, wavy, or folded sections by cutting them off.

## Adjustment Procedure

The adjustment procedure is performed in wizard format. When you proceed with operations in accordance with the instructions displayed on the screen, a set of adjustment patterns will be printed twice.

Adjustment is performed by visually checking both the first and second sets of patterns and specifying the optimal patterns.

The following shows the length and number of sheets of paper used for adjustment pattern printing.

Roll paper: Approx. 420 mm

Auto sheet feeder: 2 sheets of A4 or A3

Cut sheet: 1 sheet for A2 or larger, 2 sheets for smaller than A2

**1**

Touch the following in order from the Home screen.

- Roll paper  
Roll paper information area - **Media Adjust**
- Auto Sheet Feeder  
**Paper Setting - Auto Sheet Feeder - Media Adjust**
- Cut Sheet(1 sheet)  
**Paper Setting - Cut Sheet(1 sheet) - Media Adjust**

**2**

Touch **Start**.

Printing of the first set of adjustment patterns starts.

**! Important:**

*When using A2 size or larger cut sheet, or using roll paper with the auto cut turned off, the paper cannot be removed to print the second set of patterns even though printing of the first set of patterns has finished. Do not pull the printed paper.*

**Note:**

*A print head nozzle clogging check is performed automatically before adjustment pattern printing. If nozzles are determined to be clogged, cleaning starts and the adjustment patterns will be printed after cleaning finishes.*

### Loading and Setting the Paper

- 3** Enter the numeric value of the pattern with the least streaks among the printed adjustment patterns of #1 and then touch **Adjustment #2**.  
In the following example, pattern 0 has the least streaks so you would enter 0.

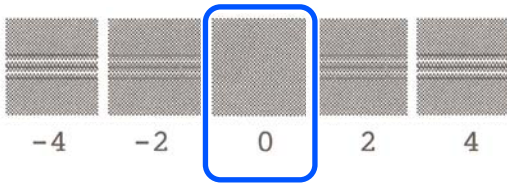

If there is no difference between two adjacent patterns and you are unsure which is the best one to choose, enter the numeric value that comes between them. For example, if you are unsure whether to enter pattern 0 or 2, enter 1.

- 4** Enter the numeric value of the pattern with the least streaks among the adjustment patterns of #2 in the same way as for #1 and then touch **Adjustment #3**.  
**5** Enter the numeric value of the pattern with the most visible straight line among the adjustment patterns of #3 and then touch **Adjustment #4**.

In the following example, pattern 0 has the most visible straight line so you would enter 0.

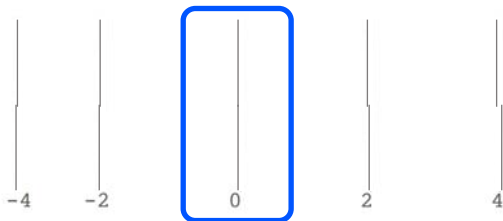

If there is no difference between two adjacent patterns and you are unsure which is the best one to choose, enter the numeric value that comes between them. For example, if you are unsure whether to enter pattern 0 or 2, enter 1.

- 6** Enter the numeric value of the pattern with the most visible straight line among the adjustment patterns of #4 in the same way as for #3.  
**7** Touch **OK**.  
Printing of the second set of adjustment patterns starts. For cut sheet smaller than A2 size, load the second sheet of paper.

**! Important:**

*When using A2 size or larger cut sheet, or using roll paper with the auto cut turned off, the part with the first set of patterns printed on it is pulled inside the printer in order to print the second set of patterns. Do not touch the paper with your hands.*

- 8** Enter the numeric value of the pattern with the least streaks among the printed adjustment patterns of #1 and then touch **Adjustment #2**.  
In the following example, pattern 0 has the least streaks so you would enter 0.

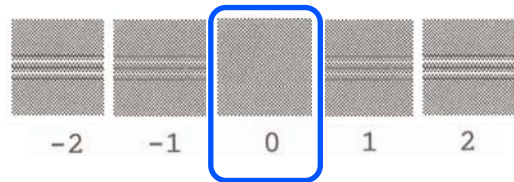

- 9** Enter the numeric value of the pattern with the least streaks among the adjustment patterns of #2 in the same way as for #1 and then touch **Adjustment #3**.  
**10** Enter the numeric value of the pattern with the least streaks among the adjustment patterns of #3 and then touch **OK**.

In the following example, pattern 0 has the least streaks so you would enter 0.

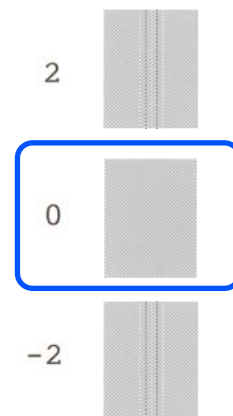

If there is no difference between two adjacent patterns and you are unsure which is the best one to choose, enter the numeric value that comes between them. For example, if you are unsure whether to enter pattern 0 or 2, enter 1.

## Loading and Setting the Paper

The adjustment results are saved as settings of the currently selected paper type. The optimal printing results can be obtained from the next time by simply selecting that paper type.

Printing with the Printer Driver from Your Computer

# Printing with the Printer Driver from Your Computer

## Basic Operating Procedures (Windows)

### Printing Procedure

This section describes the basic procedure to print various data, including the data of Word, Excel, and PowerPoint of Microsoft Office and PDFs of Adobe Acrobat, using the printer driver from a computer.

- 1 Turn on the printer, and load the paper.
  - 🔗 “Loading Roll Paper” on page 28
  - 🔗 “Loading Paper in the Auto Sheet Feeder” on page 34
  - 🔗 “Loading Cut Sheet(1 sheet)” on page 37

- 2 When you have created the data in the application, click **Print** in the **File** menu.

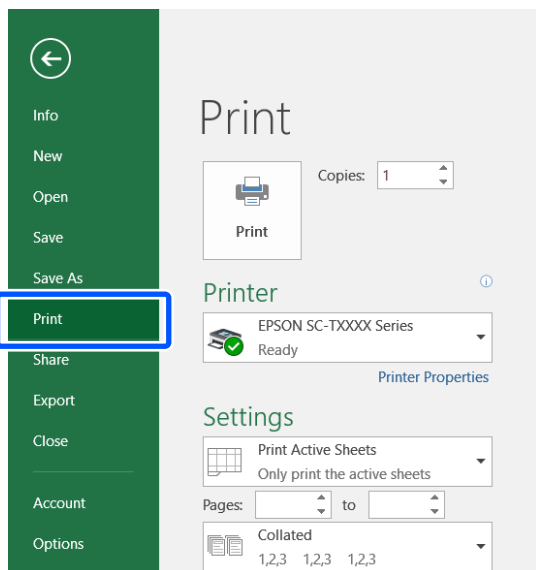

- 3 Select the printer in **Printer** and then click **Printer Properties**.

The printer driver dialog will be displayed.

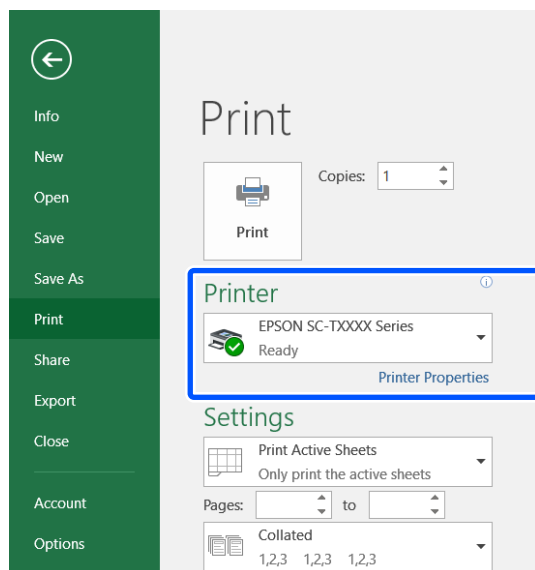

**Note:**

When printing a PDF file  
 In the Print dialog box of Adobe Acrobat, select the **Actual size** (or **Page Scaling: None**) radial button and **Choose paper source by PDF page size** check box. To enlarge or reduce the size, configure the setting in the printer driver settings dialog box.

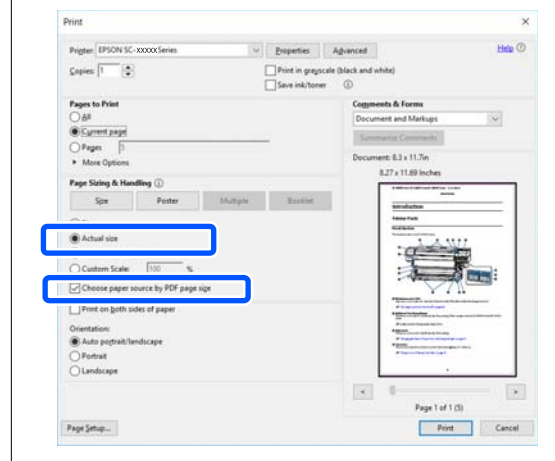

- 4 Check **Document Size** on the Printer Settings tab of the printer driver.

The paper size set in the application is displayed automatically. However, the paper sizes (page sizes) of some applications such as PowerPoint may not be displayed correctly. In such a case, click **Settings...** and specify the size in the displayed Change Paper Size dialog box.

## Printing with the Printer Driver from Your Computer

If the desired size is not available in the pull-down menu of the Change Paper Size dialog box, click **Custom Paper Size...** and then set and save a custom size.

 [“Printing at Non-Standard Sizes” on page 64](#)

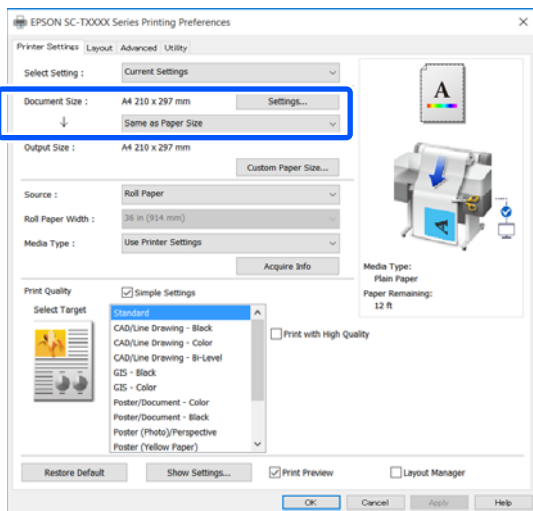

### 5 Set Output Size.

To enlarge or reduce the size, select from the pull-down menu below the Document Size.

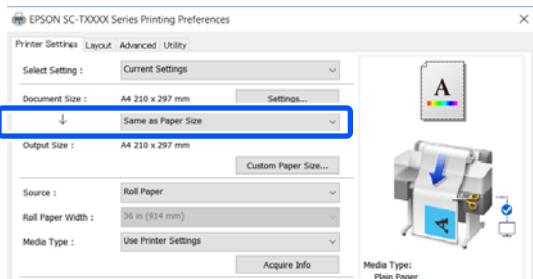

See the following for more details on enlargement settings.

 [“Enlargements and Horizontal and Vertical Banners” on page 59](#)

### 6 Select Source and check the roll paper width (paper size when cut sheet) and paper type.

Select from Roll Paper, Auto Sheet Feeder, and Sheet. If you select a paper source for which paper is not loaded in the printer,  appears.

For Roll Paper Width (Paper Size when cut sheet) and Media Type, the settings configured in the control panel of the printer are applied automatically.

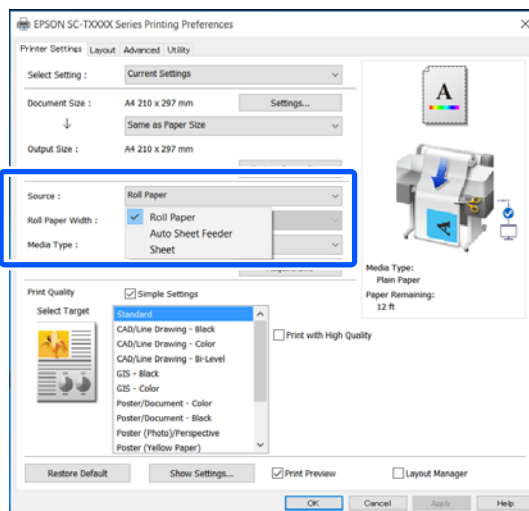

### Note:

*If the paper is loaded or changed after opening the printer driver's dialog box, the paper size and paper type settings configured on the printer will not be applied. In this case, click the **Acquire Info** button to apply the settings.*

### 7 Select Select Target in Print Quality.

Choose an option according to the type of document and how it will be used.

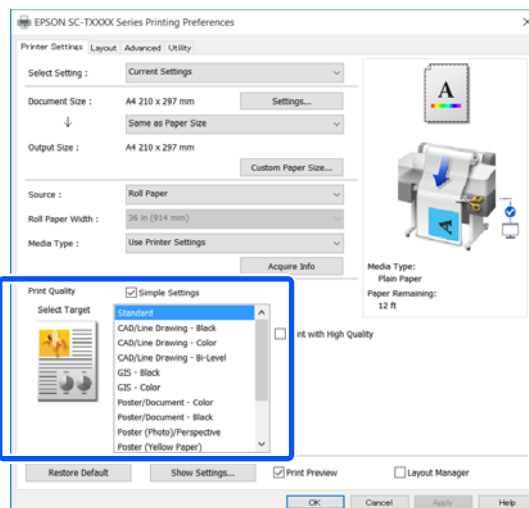

To set the color correction method or color balance in detail to match your preferences, clear the **Simple Settings** check box. See the following for more details.

 [“Correct color and print” on page 68](#)



## Printing with the Printer Driver from Your Computer

- Check that the **Print Preview** check box is selected and then click **OK**.  
If a preview is not necessary, clear the check box and then click **OK**.

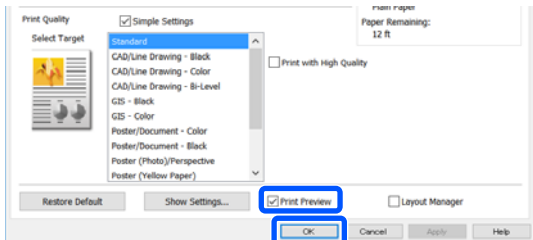

**Note:**  
In the print preview, you can check and change the print settings while viewing the image to be actually printed. We recommend to check with the preview when printing on roll paper or large-sized paper.

- Click **Print** in the Print dialog box of the application.  
The print preview screen appears.
- Check the print settings in the print preview screen, and if there is no problem, click **Print** to start printing.

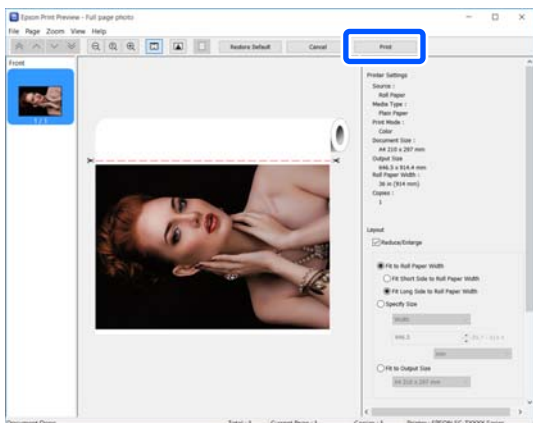

The icons and menus at the top of the preview screen allow you to change the image display settings. You can change the print settings using the menus on the right side. See the help for more details.

**Note:**  
See the printer driver help for more details on setting items. You can display the help in the following two ways:

- Click **Help** at the bottom right of the screen.
- Right-click the item you want to check and then click **Help**. (This is not possible in the print preview screen.)

## Canceling Printing

There are a few ways to stop printing operations depending on the situation. When the computer has finished sending data to the printer, you cannot cancel the print job from the computer. Cancel on the printer.

### Canceling from a Computer

**When the Progress Bar is displayed**

Click **Cancel**.

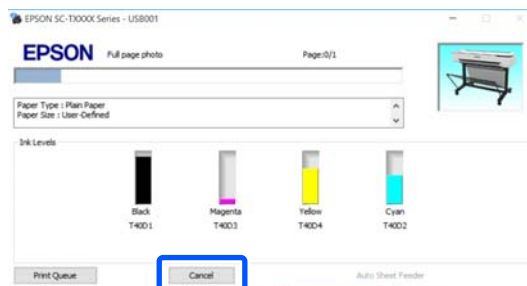

**When the Progress Bar is not displayed**

- Click the printer icon on the taskbar.



Whether or not an icon is displayed depends on the settings selected for Windows.



## Printing with the Printer Driver from Your Computer

- 2** Select the print data you want to cancel and click **Cancel** in the **Document** menu.

To cancel all print data, click **Cancel All Documents** in the **Printer** menu.

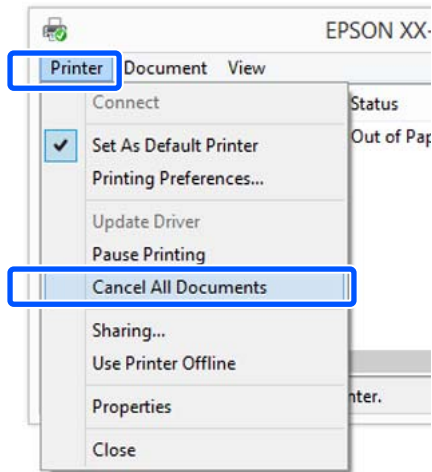

If the job has been sent to the printer, print data is not displayed on the above screen.

### Canceling on the printer

The **Cancel** button is displayed on the control panel screen during printing. Touch the **Cancel** button. The print job is canceled even in the middle of printing. It may take a while before the printer returns to the ready status.

However, print jobs in the print queue on a computer cannot be deleted in this way. Use the procedure of "Canceling from a Computer" to delete print jobs in the print queue.

## Customizing the Printer Driver

You can save the settings or change the display items as you prefer.

### Saving Frequently Used Settings

If you start the printer driver from the Control Panel, change the settings to those you use frequently, and then save the settings, the printer driver's dialog box will be displayed with the saved settings from any application that it is displayed.

- 1** Open **View devices and printers** or **Devices and Printers**.

**Windows 10/8.1/8/7**

Click in the following order: **Hardware and Sound** (or **Hardware**) > **View devices and printers** (or **Devices and Printers**).

**Windows Vista**

Click in the following order: **Hardware and Sound** and then **Printer**.

**Windows XP**

Click in the following order: **Printers and Other Hardware**, and then **Printers and Faxes**.

**Note:**

If your Windows XP Control Panel is in **Classic View**, click **Start**, **Control Panel**, and then **Printers and Faxes**.

- 2** Right-click your printer icon, and click **Printing preferences**.

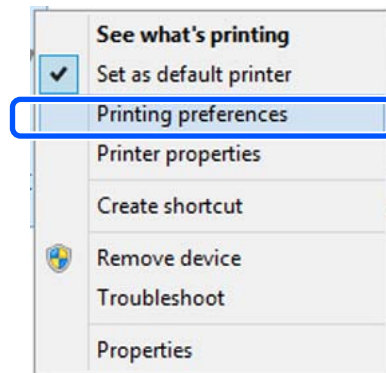

- 3** The printer driver setting screen is displayed.

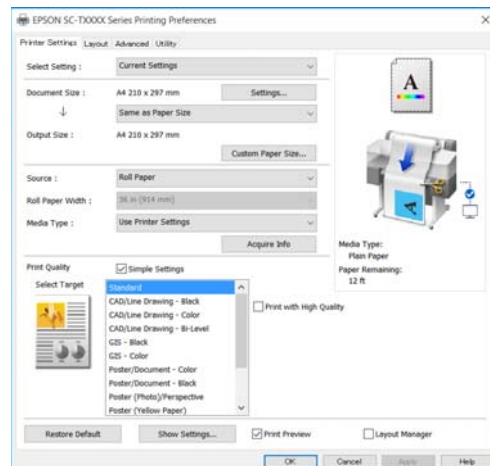

## Printing with the Printer Driver from Your Computer

Make the necessary settings. These settings become the default settings of the printer driver.

### Saving various settings as your Select Settings

You can save all printer driver settings as a Select Setting. This allows you to easily load settings that have been stored in Select Settings, and repeatedly print using exactly the same settings.

**1** Set each item on the Printer Settings, Layout, and Advanced tabs to the settings you want to save as Select Settings.

**2** Click **Custom Settings**.

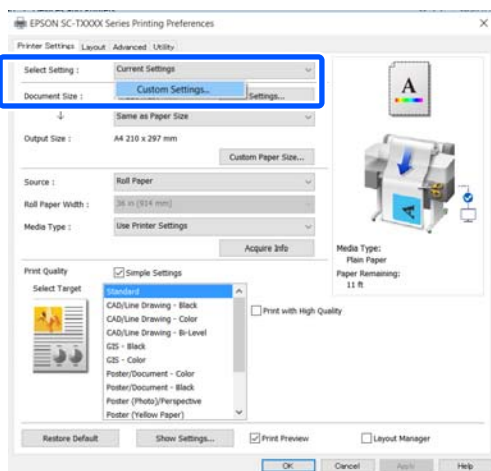

**3** Enter the desired name in **Name**, and then click **Save**.

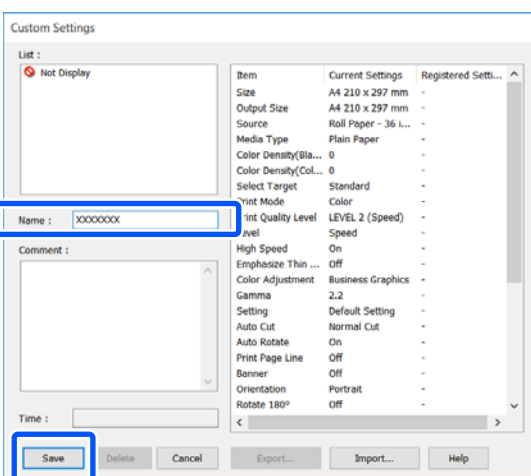

You can save up to 100. The saved select settings can be recalled from **Select Setting**.

**Note:**

**How to share Select Setting with multiple computers**

Select the settings you want to share, click **Export...**, and then export the settings to a file. Display the same screen of the printer driver on another computer, click **Import...**, and then import the settings.

### Rearranging display items

The display items of **Select Setting**, **Media Type**, and **Paper Size** can be arranged as follows to display the ones you use normally right away.

- Hide unnecessary items.
- Rearrange in an order of most frequent use.
- Arrange in groups (folders).

**1** Click **Utility** tab - **Menu Arrangement**.

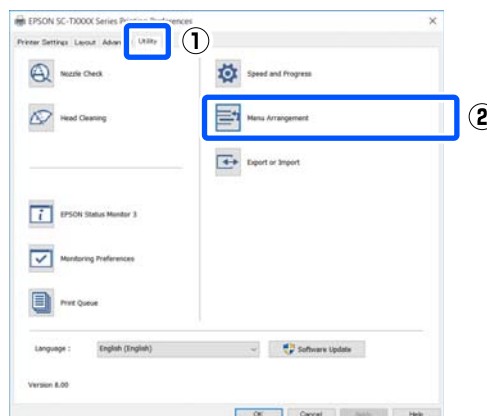

## Printing with the Printer Driver from Your Computer

### 2 Select **Edit Item**.

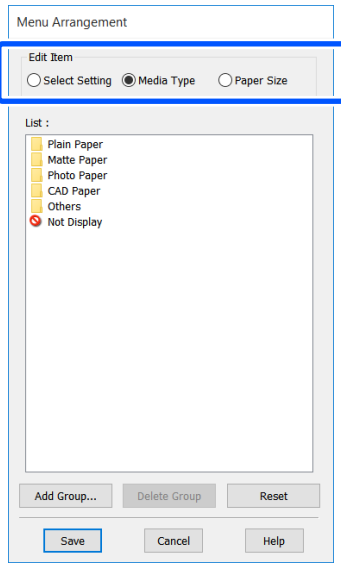

### 4 Click **Save**.

### 3 Change the display order and groups in **List**.

- ❑ You can move and order items by dragging and dropping.
- ❑ To add a new group (folder), click **Add Group...**
- ❑ To delete a group (folder), click **Delete Group**.
- ❑ Drag and drop unnecessary items to **Not Display**.

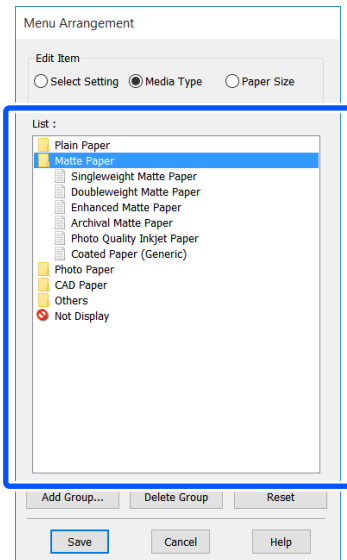

**Note:**

When **Delete Group** is performed, the group (folder) is deleted, but the settings in the deleted group (folder) remain. Delete them individually from **List** in the save location.

Printing with the Printer Driver from Your Computer

# Basic Operating Procedures (Mac)

## Printing Procedure

This section describes the basic procedure to print using the printer driver from a computer.

### Basic Printing Procedure

- 1 Turn on the printer, and load the paper.
  - ☞ “Loading Roll Paper” on page 28
  - ☞ “Loading Paper in the Auto Sheet Feeder” on page 34
  - ☞ “Loading Cut Sheet(1 sheet)” on page 37
- 2 When you have created the data in the application, click **Print** in the **File** menu.

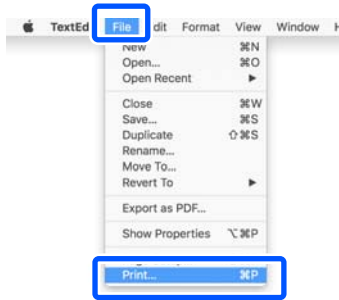

- 3 Click **Show Details** (or ) at the bottom of the screen.

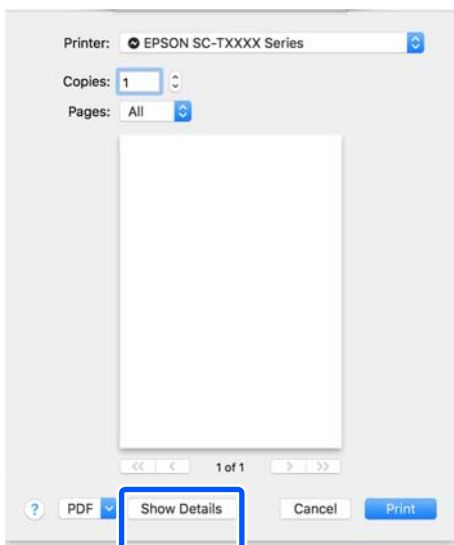

**Note:**

If page settings are not displayed in the print dialog, click the “page settings” option (e.g., **Page Setup**) in the **File** menu.

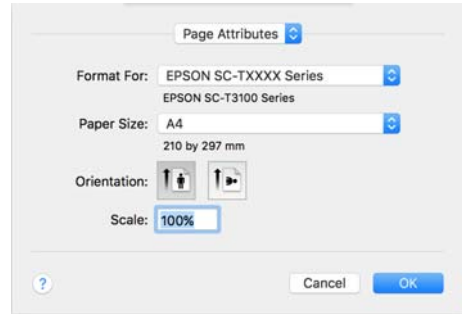

- 4 Check that this printer is selected, and then set the paper size.

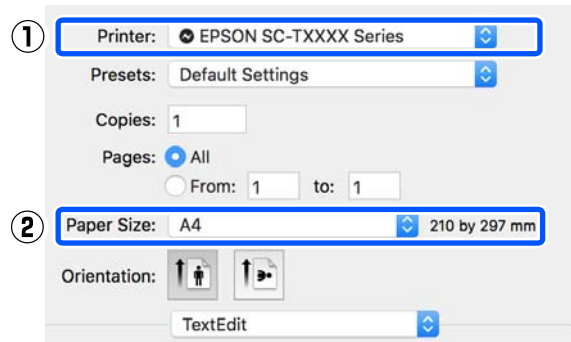

There are three options for each paper size. For example, if you click the A2 size, the following three options appear.

- A2
- A2 (Retain Scale)
- A2 (Roll Paper - Banner)

Normally, select the option without parenthesis (A2 in the example above). Select the other two options at the following times.

**Retain Scale**

PDF and image data may be printed reduced slightly even when the output size is set to **Same as Paper Size** in the following procedure. This occurs to make sure there are the margins required by the printer (3 mm on each the left and right). Select this when you want to print at the actual size without reducing the size.

**Roll Paper - Banner**

Select this when printing a banner to roll paper from an application designed for banner printing.

## Printing with the Printer Driver from Your Computer

### 5 Select **Printer Settings** from the list and set **Output Size**.

If **Printer Settings** is not displayed in the list, the dedicated printer driver for this printer has not been added. See the following and then add the printer driver.

 [“How to Select the Dedicated Printer Driver for This Printer” on page 54](#)

To enlarge or reduce the size, select from the pull-down menu below the Paper Size.

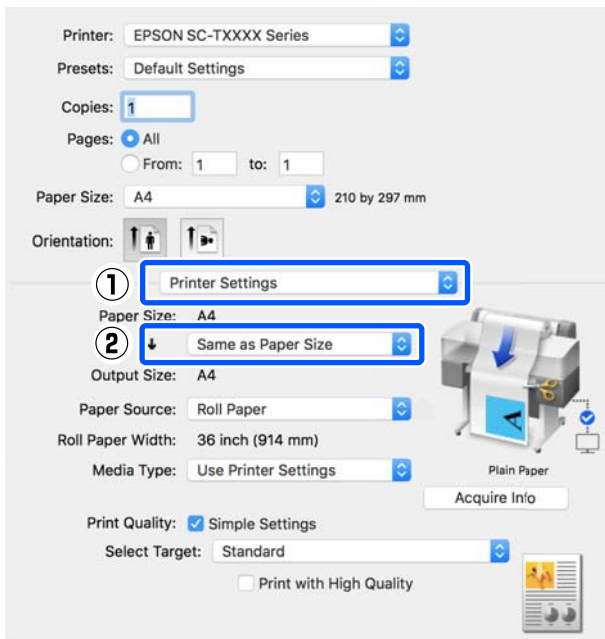

See the following for more details on enlargement settings.

 [“Enlargements and Horizontal and Vertical Banners” on page 59](#)

### 6 Select Paper Source and check the roll paper width (paper size when cut sheet) and paper type.

Select from Roll Paper, Auto Sheet Feeder, and Sheet. If you select a paper source for which paper is not loaded in the printer,  appears.

For Roll Paper Width (Paper Size when cut sheet) and Media Type, the settings configured in the control panel of the printer are applied automatically.

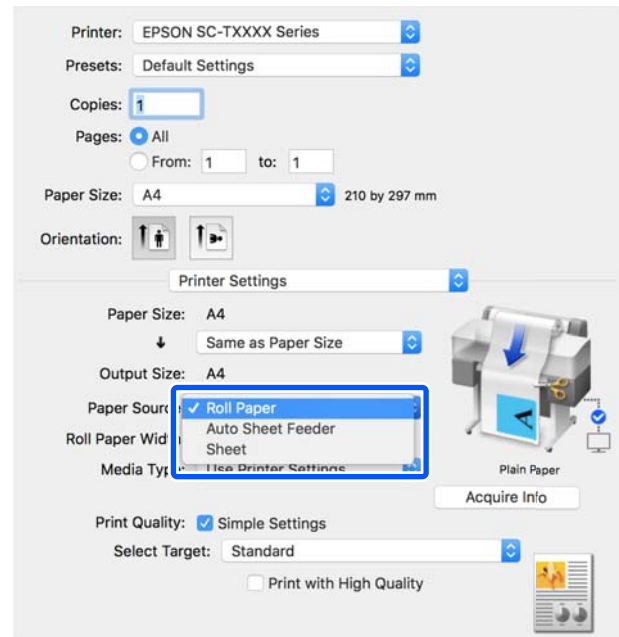

#### **Note:**

*If the paper is loaded or changed after opening the printer driver's dialog box, the paper size and paper type settings configured on the printer will not be applied. In this case, click the **Acquire Info** button to apply the settings.*

## Printing with the Printer Driver from Your Computer

- 7** Select **Select Target** in **Print Quality**.  
Choose an option according to the type of document and how it will be used.

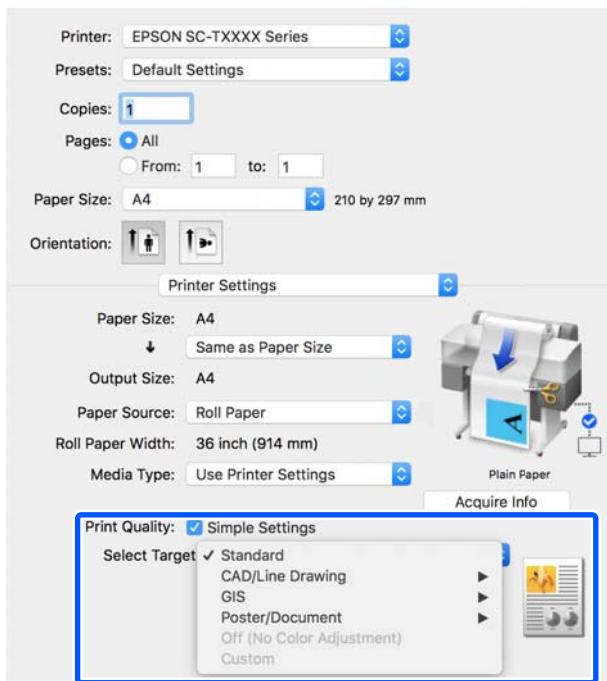

To set the color correction method or color balance in detail to match your preferences, clear the **Simple Settings** check box. See the following for more details.

["Correct color and print" on page 68](#)

- 8** Check that the **Print Preview** check box is selected and then click **Print**.

If a preview is not necessary, clear the check box and then click **Print**.

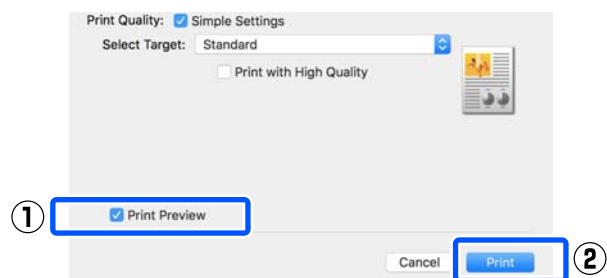

**Note:**

*In the print preview, you can check and change the print settings while viewing the image to be actually printed. We recommend to check with the preview when printing on roll paper or large-sized paper.*

- 9** Check the print settings in the print preview screen, and if there is no problem, click **Print** to start printing.

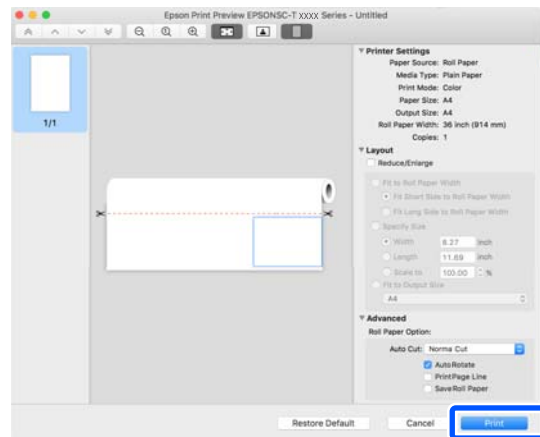

The icons and menus at the top of the preview screen allow you to change the image display settings. You can change the print settings using the menus on the right side. See the help for more details.

**Note:**

*See the printer driver help for more details on setting items. Click in the printer driver settings dialog box to display Help.*

### How to Select the Dedicated Printer Driver for This Printer

You can print using AirPrint from a Mac computer. However, printing by automatically fitting the document to the width of the roll paper and selecting a print quality suitable for the print target are not possible. If the menus described in the previous section "Basic Printing Procedure" are not displayed, select the dedicated printer driver for the printer in **Printer**. The dedicated printer driver for this printer is displayed as follows.

- When USB connection: EPSON SC-TXXXX
- When network connection: EPSON TXXXX or EPSON TXXXX-YYYYYY

\*: "XXXX" is the product model number. "YYYYYY" is the last six digits of the MAC address.

If the dedicated printer driver for this printer is not displayed in the list, add it with the following procedure.



## Printing with the Printer Driver from Your Computer

- 1 Select **System Preferences - Printers & Scanners (Print & Scan or Print & Fax)** from the Apple menu.
- 2 Click **[+]** and select **Add Printer or Scanner**.
- 3 When the list of devices appears, select the dedicated printer driver for this printer and click **Add**.

## Canceling Printing

There are a few ways to stop printing operations depending on the situation. When the computer has finished sending data to the printer, you cannot cancel the print job from the computer. Cancel on the printer.

## Canceling from a Computer

- 1 Click the icon of this printer in the Dock.



- 2 Select the job you want to cancel, and then click **Delete**.

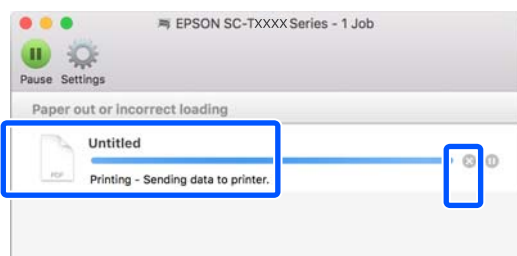

If the job has been sent to the printer, print data is not displayed on the above screen.

## Canceling on the printer

The **Cancel** button is displayed on the control panel screen during printing. Touch the **Cancel** button. The print job is canceled even in the middle of printing. It may take a while before the printer returns to the ready status.

However, print jobs in the print queue on a computer cannot be deleted in this way. Use the procedure of "Canceling from a Computer" to delete print jobs in the print queue.

## Customizing the Printer Driver

You can assign a name to frequently used setting information (paper size and each item of the basic settings) and then save the information to **Presets**. This allows you to easily load settings and repeatedly print using exactly the same settings.

## Saving Frequently Used Settings as Preset

- 1 Set each item on the Paper Size and Printer Settings tabs to the settings you want to save as Presets.
- 2 Click **Save Current Settings as Preset** in **Presets**.

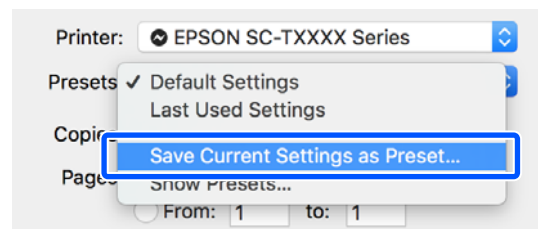

- 3 Enter a name, and then click **OK**.

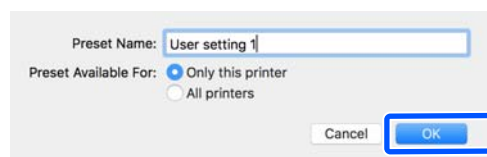

### Note:

When **All printers** is selected from **Preset Available For**, you can select the saved **Presets** from all printer drivers installed on your computer.

## Printing with the Printer Driver from Your Computer

The settings are saved to **Presets**. You can then select the settings you saved from **Presets**.

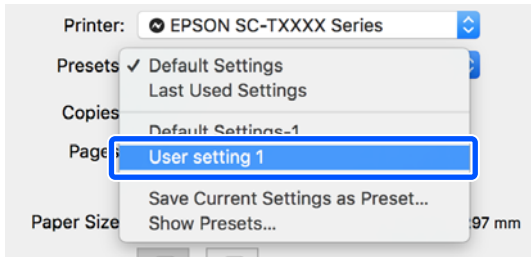

### Deleting from Presets

- 1 Click **Show Presets...** in **Presets** of the Print dialog box.

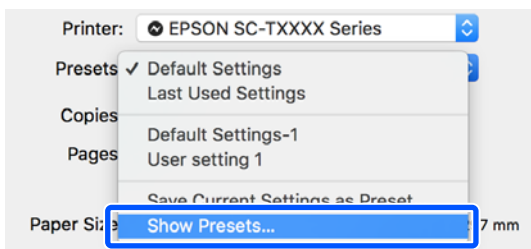

- 2 Select the setting you want to delete, click **Delete**, and then click **OK**.

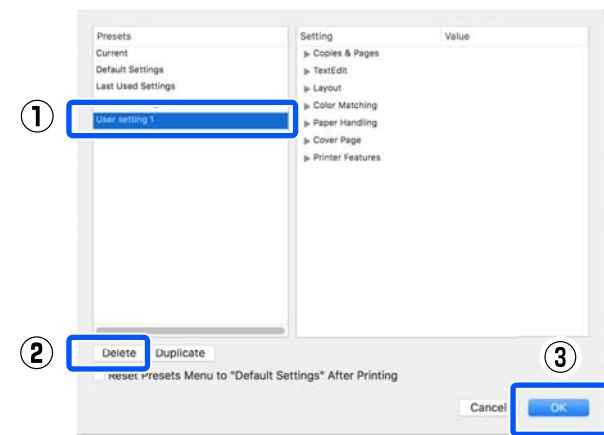



**Printing with the Printer Driver from Your Computer**

# Printing CAD Drawings

There are the following two methods to print CAD drawings.

## Printing with the printer driver

This method is best suited for printing CAD drawings such as the appearance views of buildings at high quality. This section describes the procedure to print using the printer driver from AutoCAD 2018.



**Important:**

*If lines or parts in your drawing are not printed properly, print using the HP-GL/2 or HP RTL mode.*

## Printing using the HP-GL/2 or HP RTL mode

This method is best suited for printing CAD and GIS drawings such as maps and blueprints.

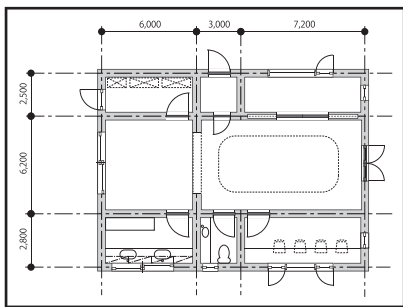

You can print from an application that supports HP-GL/2 (compatible with HP Designjet 750C) and HP RTL. See the following for more details.

[“Printing Using the HP-GL/2 or HP RTL Mode from a Computer” on page 91](#)

**1** Open the data to be printed and then click **Plot**.

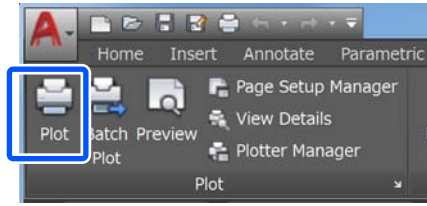

**2** Select the printer in **Printer/plotter** and then click **Properties**.

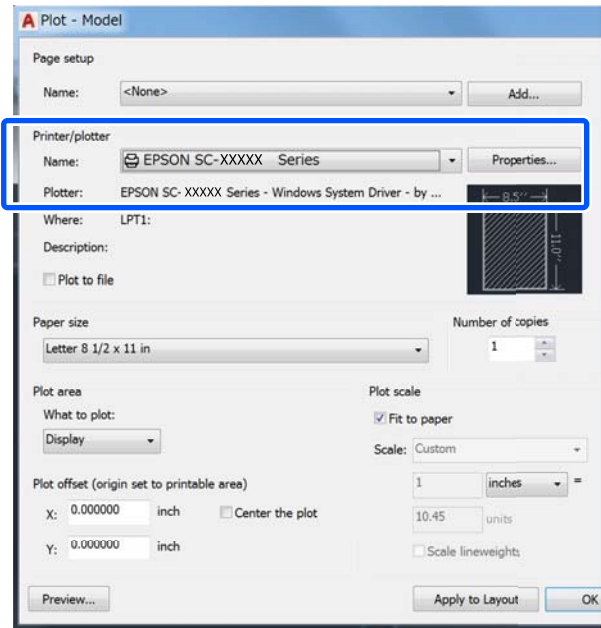

**3** Click **Custom Properties**.

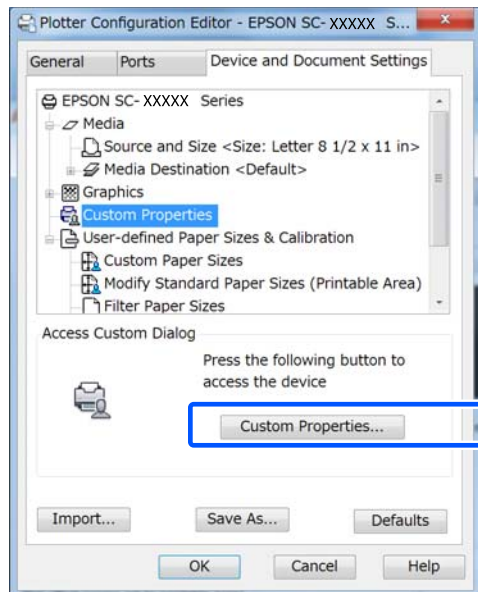

The printer driver's dialog box for this printer appears.

## Printing with the Printer Driver from Your Computer

**4** Set Output Size and Source in the printer driver.

“Basic Operating Procedures (Windows)” on page 46

“Basic Operating Procedures (Mac)” on page 52

**5** Select **CAD/Line Drawing - Black**, **CAD/Line Drawing - Color**, or **CAD/Line Drawing - Bi-Level** from the **Select Target** list.

### Windows

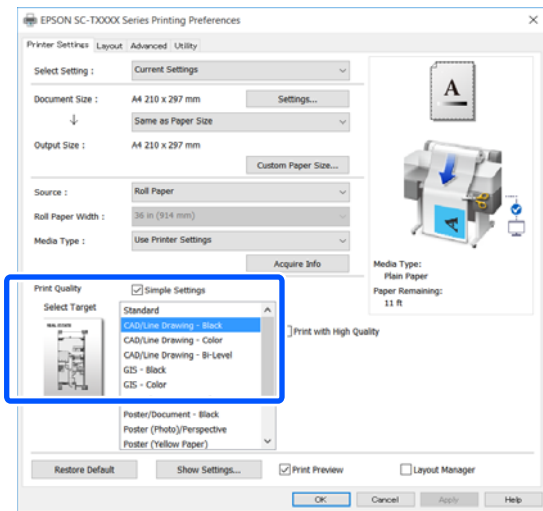

### Mac

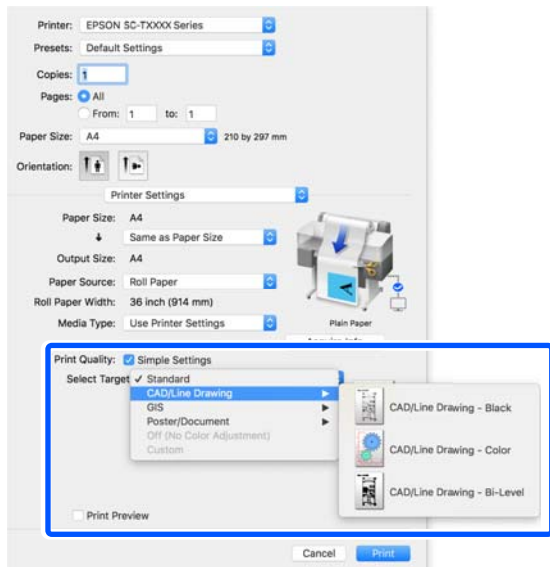

**6** Check other settings, and then start printing.

**Note:**

*If the output size is portrait and the height is smaller than the width of the roll paper, the print image is printed rotated 90° to save paper. This function is enabled if the **Auto Rotate** check box is selected in **Roll Paper Option** on the **Advanced** tab.*

Printing with the Printer Driver from Your Computer

# Enlargements and Horizontal and Vertical Banners

The printer driver can enlarge or reduce documents for different paper sizes. There are three setting methods.

Before printing at non-standard sizes, including vertical or horizontal banners and documents with equal sides, enter the desired paper size in the printer driver.

["Printing at Non-Standard Sizes" on page 64](#)

- Fit to Roll Paper Width**  
Automatically enlarges or reduces the image size to fit the roll paper width.



- Fit to Output Size**  
Automatically enlarges or reduces the image size to fit the paper size.

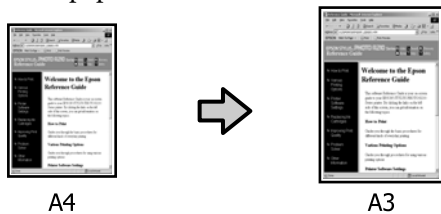

- Specify Size**  
You can specify the enlargement or reduction ratio. Use this method for a non-standard paper size.

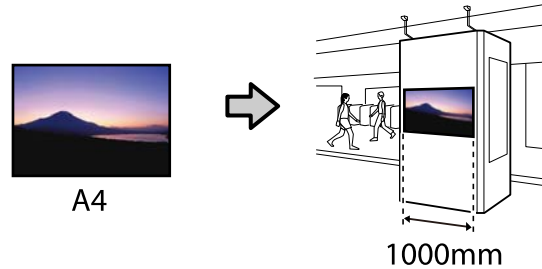

**Note:**

- When printing from applications designed expressly for horizontal or vertical banners, adjust printer driver settings as described in the application documentation.
- When using a Windows application designed for banners, select **Print Banner** on the Layout tab if necessary.

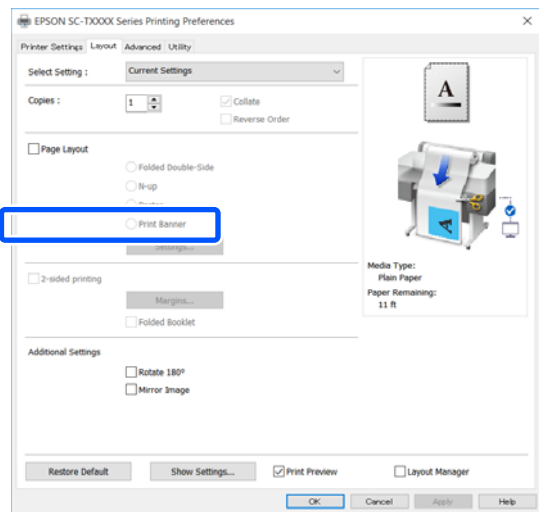

## Printing with the Printer Driver from Your Computer

### Fitting Documents to the Width of the Roll Paper

- 1 Check the document size (or paper size) setting on the Printer Settings tab of the printer driver.

#### Windows

Display the Printer Settings tab of the printer driver from the application and check that the document size is the same as the setting of the application.

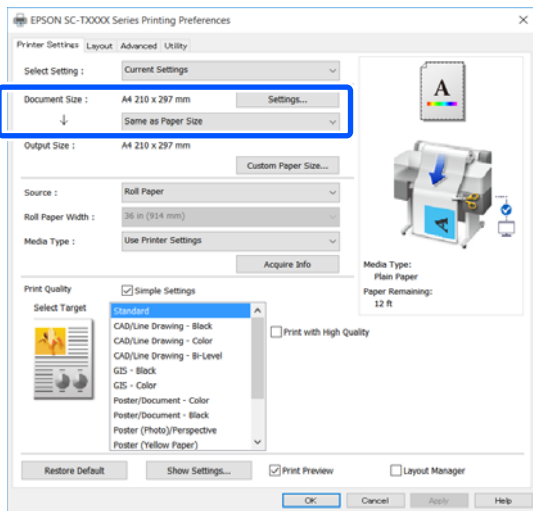

If it differs, click **Settings...** and specify the correct size in the Change Paper Size dialog box.

📖 “Basic Operating Procedures (Windows)” on page 46

#### Mac

Open the page setup screen of the application and check that this printer is selected in **Printer** and check the paper size.

Select a paper size that does not have (Retain Scale) or (Roll Paper - Banner).

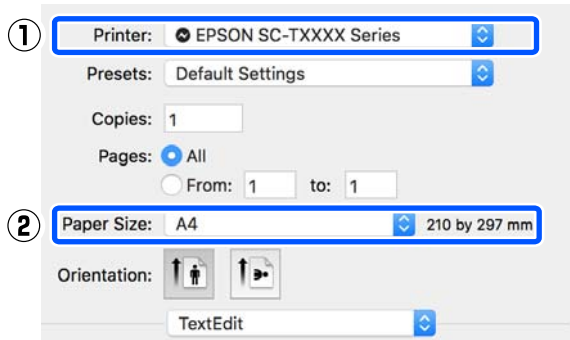

If the size is different, select the correct size from the pull-down menu.

📖 “Basic Operating Procedures (Mac)” on page 52

#### Note:

*In the case of an application without a page setup menu item, you can set the paper size if you open the Print dialog box from the **Print** menu item.*

- 2 Click **Fit to Roll Paper Width** on the Printer Settings tab of the printer driver and select either **Fit Short Side to Roll Paper Width** or **Fit Long Side to Roll Paper Width**.

#### Windows

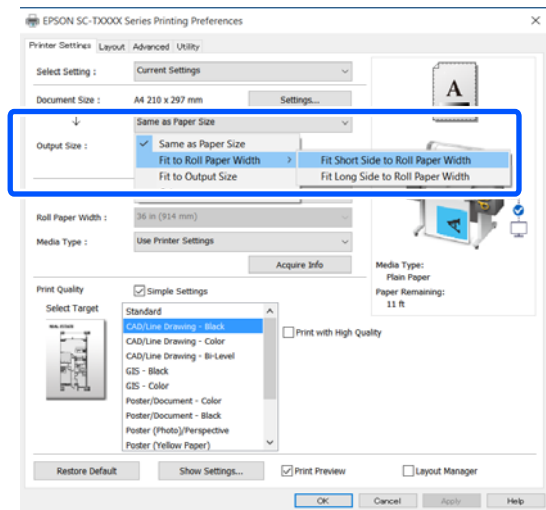

#### Mac

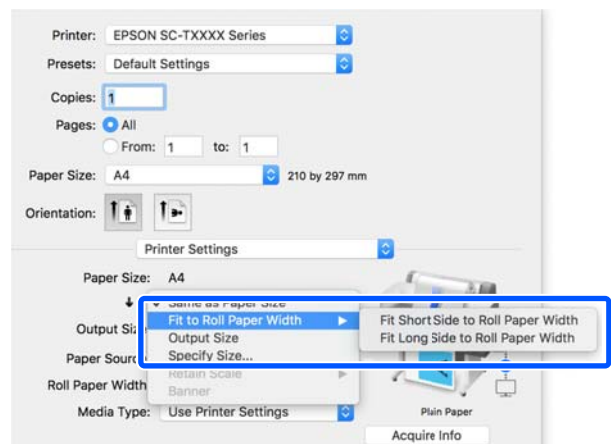

## Printing with the Printer Driver from Your Computer

### Fit Short Side to Roll Paper Width

Select this when you want to print with the print image enlarged to the maximum size for the loaded roll paper.

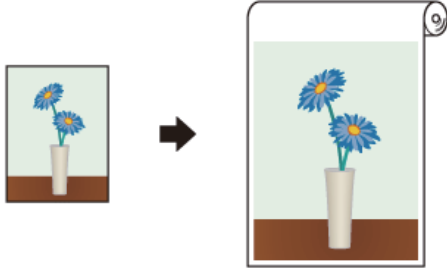

### Fit Long Side to Roll Paper Width

Select this when you want to print with the print image enlarged as much as possible to the extent that paper will not be wasted.



- 3 Check other settings, and then start printing.

## Fitting Documents to the Output Size

- 1 Check the document size (or paper size) setting on the Printer Settings tab of the printer driver.

### Windows

Display the Printer Settings tab of the printer driver from the application and check that the document size is the same as the setting of the application.

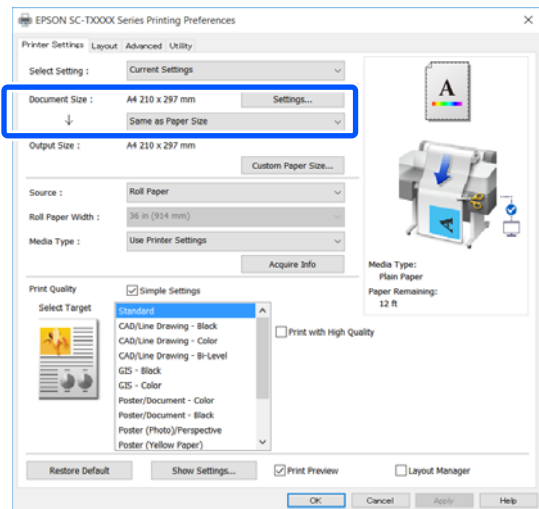

If it differs, click **Settings...** and specify the correct size in the Change Paper Size dialog box.

[“Basic Operating Procedures \(Windows\)” on page 46](#)

### Mac

Open the page setup screen of the application and check that this printer is selected in **Printer** and check the paper size.

Select a paper size that does not have (Retain Scale) or (Roll Paper - Banner).

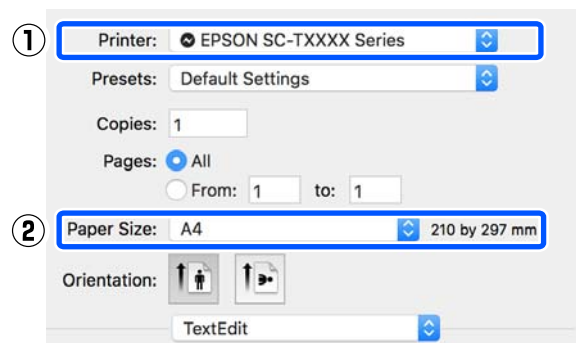

## Printing with the Printer Driver from Your Computer

If the size is different, select the correct size from the pull-down menu.

 [“Basic Operating Procedures \(Mac\)”](#) on page 52

- 2 Select **Fit to Output Size** on the Printer Settings tab of the printer driver.

### Windows

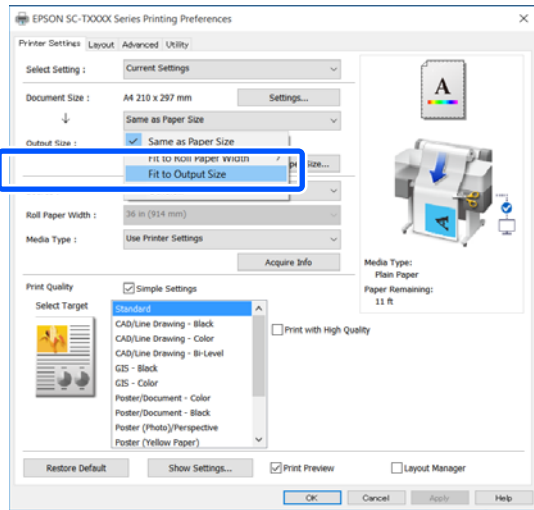

### Mac

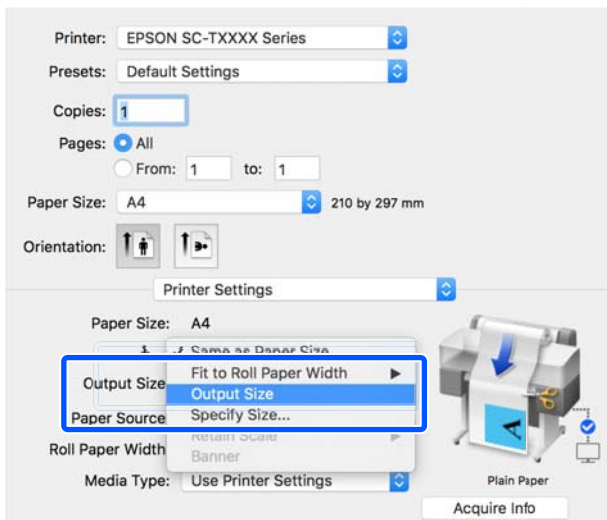

- 3 Select the desired size from the **Output Size** pull-down menu.

### Windows

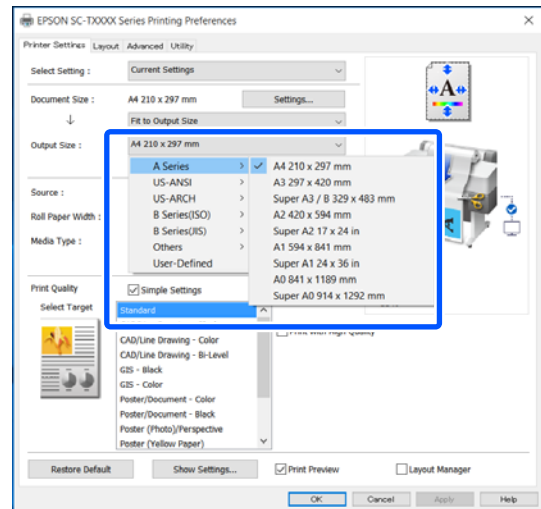

### Mac

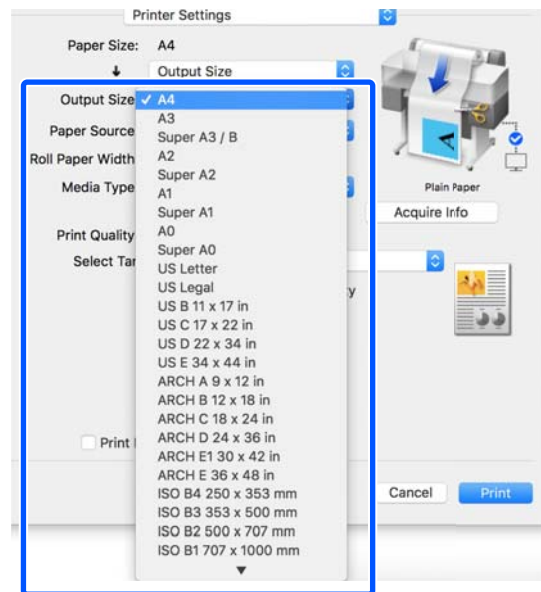

- 4 Check other settings, and then start printing.



## Printing with the Printer Driver from Your Computer

### Choosing a Print Size

- 1 Check the document size (or paper size) setting on the Printer Settings tab of the printer driver.

#### Windows

Display the Printer Settings tab of the printer driver from the application and check that the document size is the same as the setting of the application.

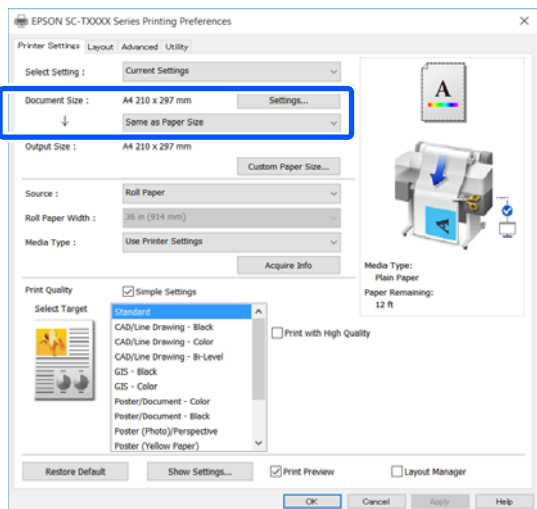

If it differs, click **Settings...** and specify the correct size in the Change Paper Size dialog box.

[“Basic Operating Procedures \(Windows\)” on page 46](#)

#### Mac

Open the page setup screen of the application and check that this printer is selected in **Printer** and check the paper size.

Select a paper size that does not have (Retain Scale) or (Roll Paper - Banner).

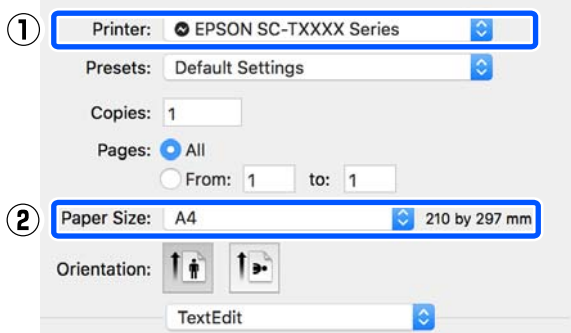

If the size is different, select the correct size from the pull-down menu.

[“Basic Operating Procedures \(Mac\)” on page 52](#)

#### Note:

*In the case of an application without a page setup menu item, you can set the paper size if you open the Print dialog box from the **Print** menu item.*

- 2 Display the Output Size input screen from the Printer Settings tab of the printer driver.

#### Windows

Select **Others...** and then select **Specify Size** in the displayed Output Size dialog box.

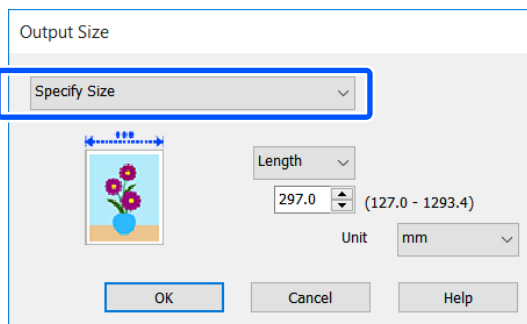
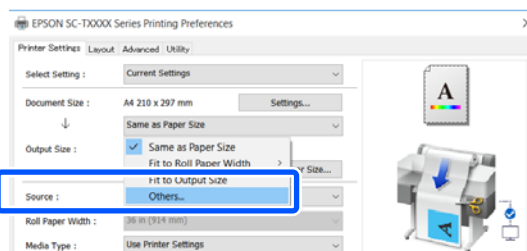

#### Mac

Select **Specify Size**.

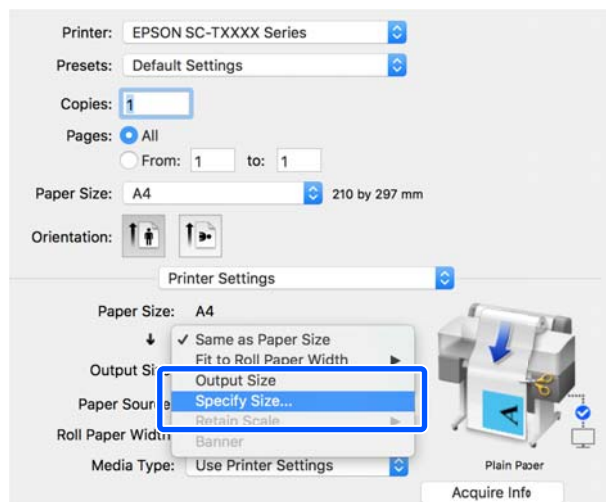

**Printing with the Printer Driver from Your Computer**

**3** Select the size specification method from Width, Length, and Scale to and then enter the setting value.

The print image is enlarged or reduced so that it becomes the specified width, length, or scale while maintaining the aspect ratio of the print data.

**Windows**

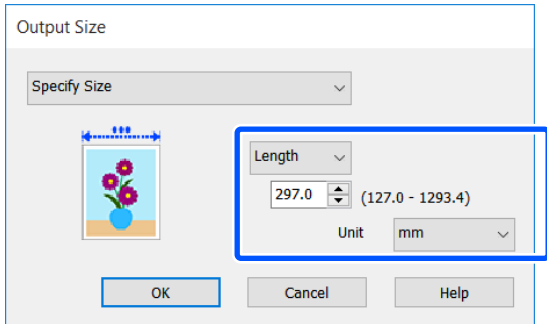

**Mac**

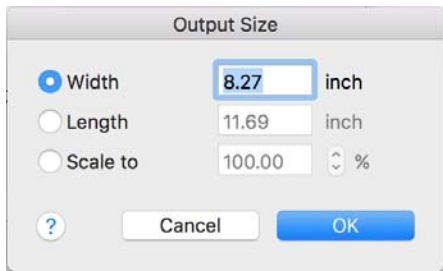

**4** Check other settings, and then start printing.

**Printing at Non-Standard Sizes**

Before printing at non-standard sizes, including vertical or horizontal banners and documents with equal sides, save the desired paper size in the printer driver. Once they have been saved in the printer driver, custom sizes can be selected in the application **Page Setup** and other print dialogs.

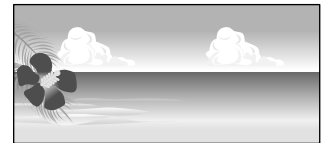

The following sizes can be used.

Paper Width	SC-T5100 Series / SC-T5100N Series	89 to 914 mm
	SC-T3100 Series / SC-T3100N Series	89 to 610 mm
Paper Length*	127 to 18000 mm	

\*: The paper length can be longer when using an application that supports banner printing. However, the actual print size depends on the application, the paper size loaded in the printer, and the computer environment.

**Important:**

- The smallest size supported by the printer is 89 mm wide × 127 mm long. When a smaller size than this is set in **Custom Paper Size...** of the printer driver, trim the unnecessary margins.
- For Custom Paper Sizes of a Mac, although you can specify a large paper size which cannot be loaded in this printer, it will not be printed properly.
- The available output size is limited depending on the application.



## Printing with the Printer Driver from Your Computer

### Making Settings in Windows

- 1 Display the Printer Settings tab of the printer driver from the application and then click **Custom Paper Size...**

The User-Defined Paper Size dialog box appears.

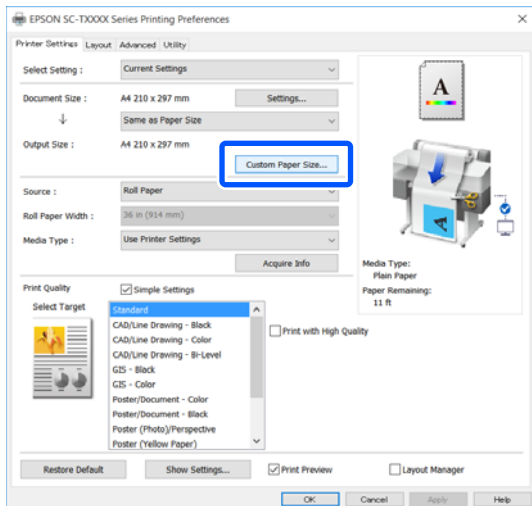

- 2 Set the paper size to use in the User-Defined Paper Size dialog box and then click **Save**.

- The **Paper Size Name** is displayed as a document size or output size option. Set a meaningful name such as "400x500mm" or "Horizontal Banner".
- To view the **Paper Width** and **Paper Height** values for a standard size close to the desired custom size, select the appropriate option in **Base Paper Size**.
- If you select an aspect ratio in **Fix Aspect Ratio** and select **Landscape** or **Portrait** for **Base**, you can set the size by just entering a value in either **Paper Width** or **Paper Height**.

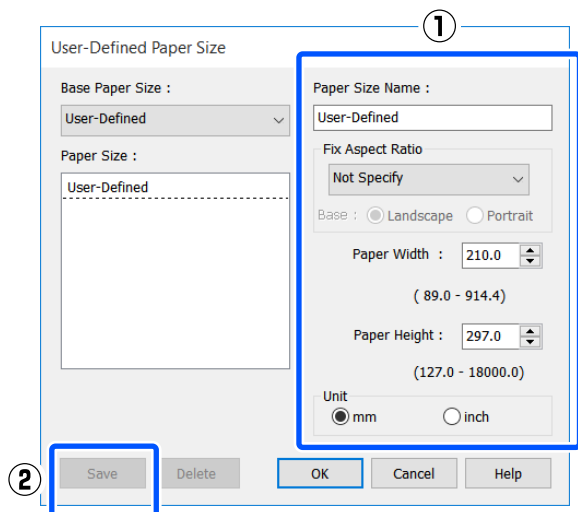

#### Note:

- To change the paper size you saved, select the paper size name from the list on the left.
- To delete a saved paper size, select the paper size name from the list on the left of the screen and then click **Delete**.
- You can save up to 100 paper sizes.

- 3 Click **OK** to close the User-Defined Paper Size dialog box. Also close the printer driver's dialog box.

Registration of the user-defined size is now complete.

- 4 Select the registered paper size in, for example, the page size settings of the application and then create the data.

#### Note:

If the registered paper size is not displayed in the application, check whether it exceeds the sizes supported by the application.

- 5 When you have finished creating the data, display the Printer Settings tab of the printer driver from the Print dialog box.

The registered paper size is displayed in Paper Size on the Printer Settings tab.

[📖 "Basic Operating Procedures \(Windows\)" on page 46](#)

- 6 Check other settings, and then start printing.

## Printing with the Printer Driver from Your Computer

### Settings in Mac

- 1 Open the page setup screen of the application and check that this printer is selected in **Printer** and then select **Manage Custom Sizes** from **Paper Size**.

“Basic Operating Procedures (Mac)” on page 52

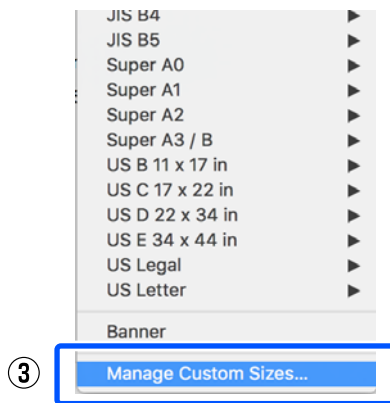
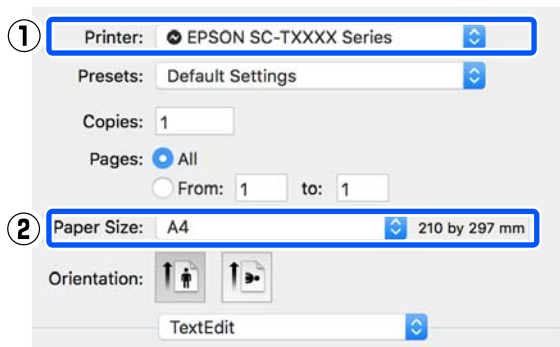

**Note:**

In the case of an application without a page setup menu item, the paper size settings can be displayed by opening the **Print** dialog box from the **Print** menu item.

- 2 Click **+** and then enter the paper size name.

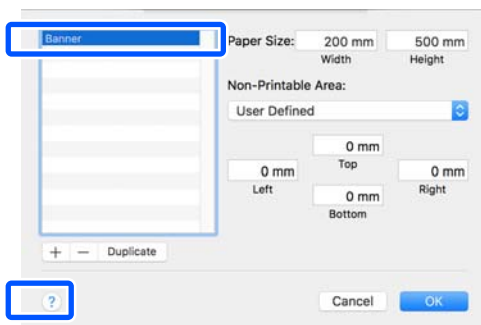

- 3 Enter values in **Width** and **Height** of the **Paper Size**, enter the margins, and then click **OK**.

The ranges of page sizes and margin sizes that can be specified differ depending on your printer model and the settings on the printer.

“Printable area” on page 163

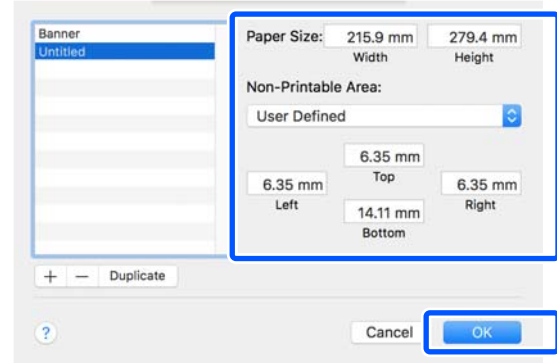

**Note:**

- To edit a saved custom size, choose its name from the list on the left.
- To duplicate a saved paper size, select its name from the list on the left of the screen and click **Duplicate**.
- To delete a saved paper size, select its name from the list on the left of the screen and click **-**.
- The custom paper size setting differs depending on the operating system version. See your operating system's documentation for details.

- 4 Click **OK** to close the Custom Paper Sizes dialog box. Also close the printer driver's dialog box by clicking **Cancel**.

Registration of the custom paper size is now complete.

- 5 Select the registered paper size in, for example, the page size settings of the application and then create the data.

**Note:**

If the registered paper size is not displayed in the application, check whether it exceeds the sizes supported by the application.

## Printing with the Printer Driver from Your Computer

- 6 When you have finished creating the data, display the Printer Settings tab of the printer driver from the Print dialog box.

The registered paper size is displayed in Document Size on the Printer Settings tab.

 [“Basic Operating Procedures \(Mac\)” on page 52](#)

- 7 Check other settings, and then start printing.

## Printing with the Printer Driver from Your Computer

### Correct color and print

The optimal method is selected from the following color correction methods for each print target in the print quality settings of the printer driver.

- EPSON Standard (sRGB)  
Optimizes the sRGB space and corrects the color.
- Business Graphics  
Performs color correction to sharpen your images based on the sRGB space.
- Line Drawing  
Optimizes color correction for line drawing by processing the border between lines and the background as discontinuous.
- GIS  
Performs the optimal printing for topographic maps and other data of the geographic information system (GIS).
- ICM  
Performs color management to match the colors in the image data to those in the printed output (Windows only).  
[🔗 “Color Management Printing” on page 72](#)
- Off (No Color Adjustment)  
Color correction is not performed by the printer driver. Choose if color management is performed by the application.  
[🔗 “Color Management Printing” on page 72](#)

If you clear the **Simple Settings** check box, you can check which of the above color correction methods is used. **Standard of Select Target** is the most suitable setting for the currently selected paper type.

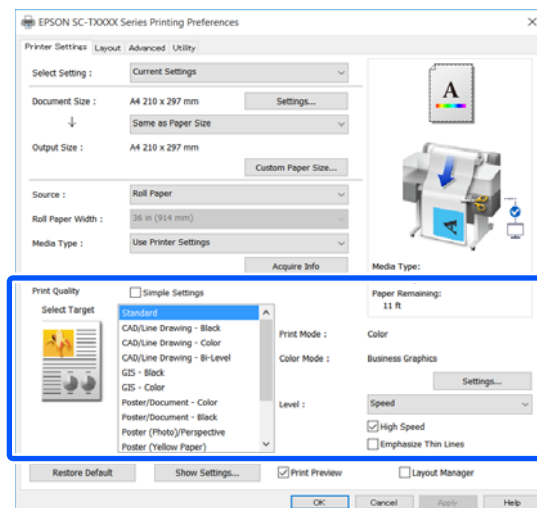

Clicking the **Settings...** button allows you to, for example, finely adjust the Gamma, Brightness, Contrast, Saturation, and color balance.

Use this option when the application in use does not have a color correction function.

**Note:**

*The color correction options available vary with the operating system and the type of paper used.*

If you want to select the color correction method yourself, select **Custom** at the very bottom of the print target list.

#### Making Settings in Windows

- 1** When using applications featuring a color management function, specify how to adjust colors from these applications.

When using applications without a color management function, start from Step 2.

Depending on the type of the application, make the settings following the table below.

Adobe Photoshop CS3 or later  
Adobe Photoshop Elements 6 or later  
Adobe Photoshop Lightroom 1 or later

### Printing with the Printer Driver from Your Computer

OS	Color Management Settings
Windows 10, Windows 8.1, Windows 8, Windows 7, Windows Vista	Printer Manages Colors
Windows XP (Service Pack 2 or later and .NET 3.0 or later)	Printer Manages Colors
Windows XP (other than the above)	No Color Management

In other applications, set **No Color Management**.

**Note:**

For information on supported platforms, see the website for the application in question.

Setting example of Adobe Photoshop CC

Open the **Print** dialog box.

Select **Color Management**, select **Printer Manages Colors** in **Color Handling**, and click **Print**.

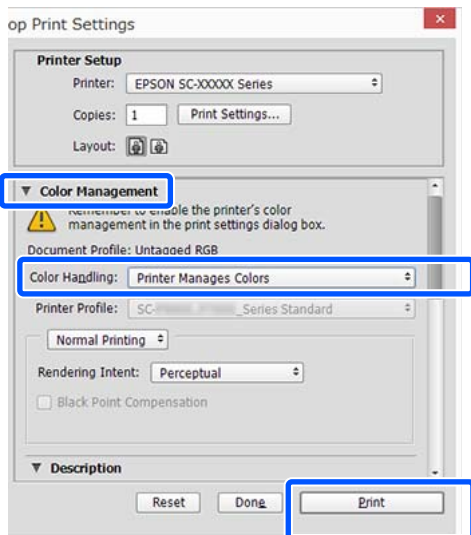

**2** Display the **Printer Settings** tab of the printer driver and then clear the **Simple Settings** check box in the **Print Quality** area.

[“Basic Operating Procedures \(Windows\)” on page 46](#)

**3** Select the print target. If you want to select the color correction method yourself, select **Custom** at the very bottom of the list.

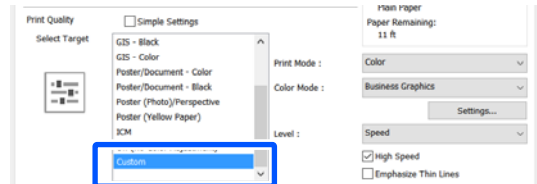

**4** When **Custom** is selected for the print target, select the color and color correction method settings.

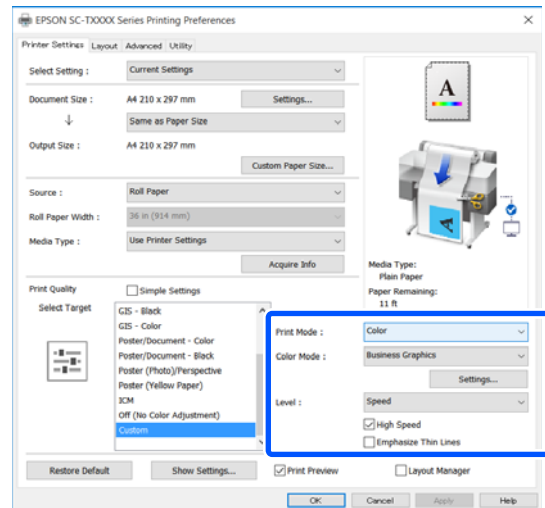

## Printing with the Printer Driver from Your Computer

- 5** If necessary, click **Settings...** and then adjust items such as the Gamma, Brightness, Contrast, Saturation, and color balance.

See the printer driver help for more details on each item.

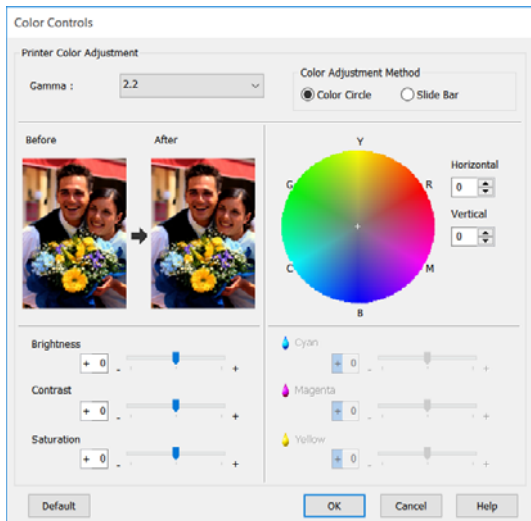

**Note:**

You can adjust the correction value by checking the sample image on the left side of the screen. Furthermore, you can select **Color Circle** or **Slide Bar** of **Color Adjustment Method** and finely adjust the color balance.

- 6** Check other settings, and then start printing.

### Settings in Mac

- 1** When using applications featuring a color management function, specify how to adjust colors from these applications.

When using applications without a color management function, start from Step 2.

When using the following applications, set the color management setting to **Printer Manages Colors**.

- Adobe Photoshop CS3 or later
- Adobe Photoshop Elements 6 or later
- Adobe Photoshop Lightroom 1 or later

In other applications, set **No Color Management**.

**Note:**

For information on supported platforms, see the website for the application in question.

Setting example of Adobe Photoshop CC

Open the **Print** dialog box.

Select **Color Management**, select **Printer Manages Colors** in **Color Handling**, and click **Print**.

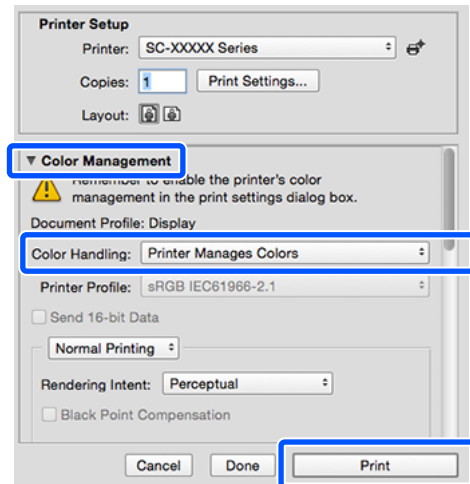

- 2** Display the Print screen.

➔ [“Basic Operating Procedures \(Mac\)” on page 52](#)

- 3** Select **Color Matching** from the list, and then click **EPSON Color Controls**.

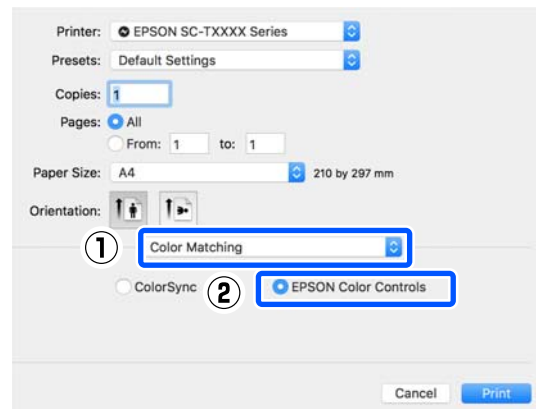

**Note:**

**EPSON Color Controls** will not be available in the following applications if Step 1 is omitted.

- Adobe Photoshop CS3 or later
- Adobe Photoshop Lightroom 1 or later
- Adobe Photoshop Elements 6 or later

### Printing with the Printer Driver from Your Computer

- 4** Select **Printer Settings** from the list and then clear the **Simple Settings** check box in the **Print Quality** area.

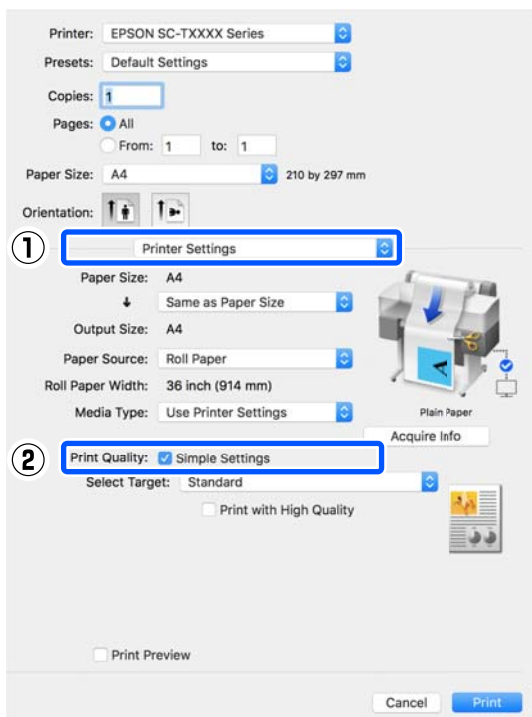

- 5** Select the print target. If you want to select the color correction method yourself, select **Custom** at the very bottom of the list.

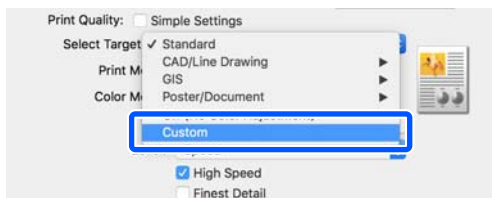

- 6** When **Custom** is selected for the print target, select the color and color correction method settings.

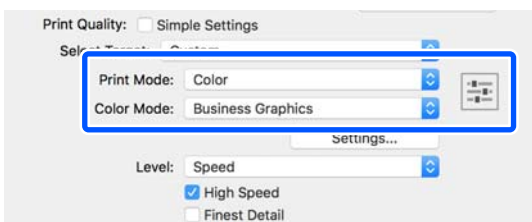

- 7** If necessary, click **Settings...** and then adjust items such as the Gamma, Brightness, Contrast, Saturation, and color balance.

See the printer driver help for more details on each item.

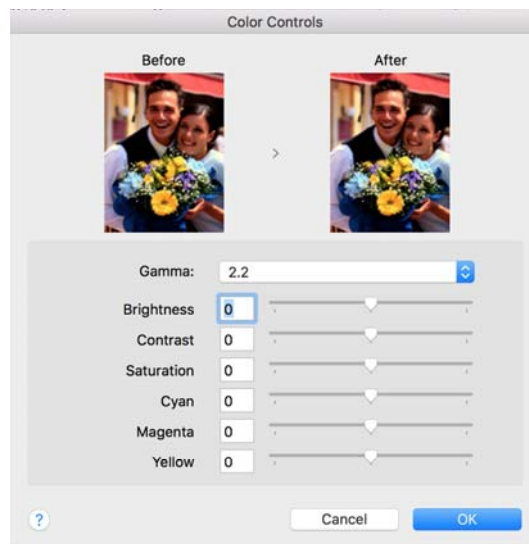

- 8** Check other settings, and then start printing.



## Printing with the Printer Driver from Your Computer

# Color Management Printing

## About Color Management

Even when using the same image data, the original image and the displayed image may look different, and the printed results may look different to the image you see on the display. This occurs due to the difference in characteristics when input devices such as scanners and digital cameras capture colors as electronic data, and when output devices such as display screens and printers reproduce colors from the color data. The color management system is a means to adjust differences in color conversion characteristics among input and output devices. A color management system is included with operating systems such as Windows and Mac OS, in addition to image processing applications. Windows and Mac OS X include the ICM and ColorSync color management systems, respectively.

In a color management system, a color definition file called a "Profile" is used to perform color matching between devices. (This file is also called an ICC profile.) The profile of an input device is called an input profile (or source profile), and the profile of an output device, such as a printer, is called a printer profile (or output profile). A profile is prepared for each media type in this printer's driver.

The color conversion areas by the input device and the color reproduction area by the output device differ. As a result, there are color areas that do not match even when performing color matching using a profile. In addition to specifying profiles, the color management system also specifies conversion conditions for areas where color matching failed as "intent". The name and type of intent vary depending on the color management system you are using.

You cannot match the colors on the printed results and display by color management between the input device and the printer. To match both colors, you need to perform color management between the input device and the display as well.

## Color Management Print Settings

You can perform color management printing using this printer's printer driver in the following two ways.

Choose the best method according to the application you are using, the operating system environment, the aim of the print out, and so on.

### Setting color management with the applications

This method is for printing from applications that support color management. All color management processes are carried out by the application's color management system. This method is useful when you want to obtain the same color management print results using a common application among different operating system environments.

[☞ "Setting color management with the applications" on page 73](#)

### Setting color management with the printer driver

The printer driver uses the operating system's color management system and carries out all color management processes. You can configure the color management settings in the printer driver using the following two methods.

- ❑ Host ICM (Windows) / ColorSync (Mac OS X)  
Set when printing from applications that support color management. This is effective in producing similar print results from different applications under the same operating systems.  
[☞ "Color Management Printing by Host ICM \(Windows\)" on page 75](#)  
[☞ "Color Management Printing by ColorSync \(Mac\)" on page 76](#)
- ❑ Driver ICM (Windows only)  
This allows you to perform color management printing from applications that do not support color management.  
[☞ "Color Management Printing by Driver ICM\(Windows Only\)" on page 77](#)



## Printing with the Printer Driver from Your Computer

### Setting profiles

Settings for the input profile, printer profile, and intent (matching method) vary between three types of color management printing since their color management engines are used differently. This is because color management usage differs between the engines. Make settings in the printer driver or application as described in the following table.

	Input profile settings	Printer profile settings	Intent settings
Driver ICM (Windows)	Printer Driver	Printer Driver	Printer Driver
Host ICM (Windows)	Application	Printer Driver	Printer Driver
ColorSync (Mac OS X)	Application	Printer Driver	Application
Application	Application	Application	Application

Printer profiles for each paper type that is needed when performing color management are installed with the printer's printer driver. You can select the profile from the printer driver's settings screen.

You can select the profile from the printer driver's settings screen.

[“Color Management Printing by Driver ICM\(Windows Only\)” on page 77](#)

[“Color Management Printing by Host ICM \(Windows\)” on page 75](#)

[“Color Management Printing by ColorSync \(Mac\)” on page 76](#)

[“Setting color management with the applications” on page 73](#)

### Setting color management with the applications

Print using applications with a color management function. Make the color management settings in the application and disable the printer driver's color adjustment function.

**1** Make color management settings in the applications.

Setting example of Adobe Photoshop CC

Open the **Print** dialog box.

Select **Color Management**, select **Photoshop Manages Colors** in **Color Handling**, select **Printer Profile** and **Rendering Intent**, and click **Print**.

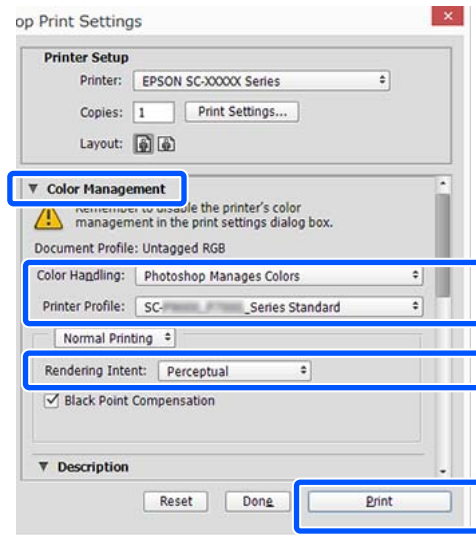

**2** Display the printer driver's settings screen (Windows) or Print screen (Mac).

Make printer driver settings.

**For Windows**

[“Basic Operating Procedures \(Windows\)” on page 46](#)

**For Mac**

[“Basic Operating Procedures \(Mac\)” on page 52](#)

### Printing with the Printer Driver from Your Computer

**3** Set color management to off.

#### For Windows

Clear the **Simple Settings** check box in the Print Quality area of the **Printer Settings** tab and select **Off (No Color Adjustment)** from the print target list.

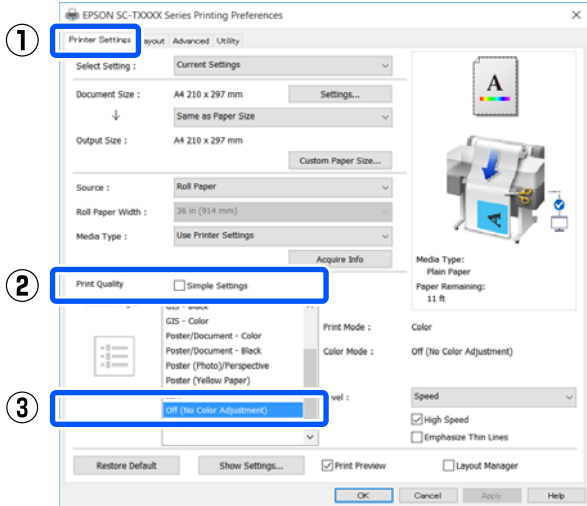

**Note:**

*In Windows 7, Windows Vista, and Windows XP (Service Pack 2 or later and .NET 3.0), **Off (No Color Adjustment)** is selected automatically.*

#### For Mac

Select **Printer Settings** from the list and clear the **Simple Settings** check box in the Print Quality area, and select **Off (No Color Adjustment)** from the print target list.

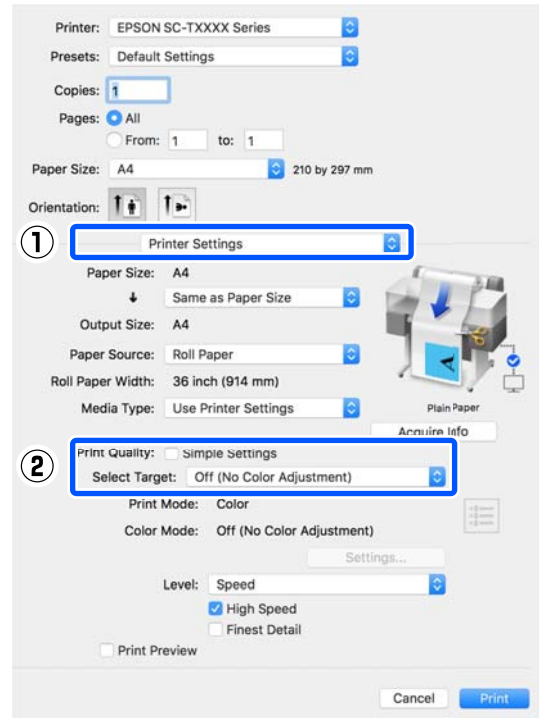

**4** Check other settings, and then start printing.

## Printing with the Printer Driver from Your Computer

### Setting color management with the printer driver

#### Color Management Printing by Host ICM (Windows)

Use image data in which an input profile has been embedded. Also, the application must support ICM.

- 1 Make the settings for color adjustment using the application.

Depending on the type of the application, make the settings following the table below.

Adobe Photoshop CS3 or later  
 Adobe Photoshop Elements 6.0 or later  
 Adobe Photoshop Lightroom 1 or later

OS	Color Management Settings
Windows 8.1, Windows 8, Windows 7, Windows Vista	Printer Manages Colors
Windows XP (Service Pack 2 or later and .NET 3.0 or later)	Printer Manages Colors
Windows XP (other than the above)	No Color Management

In other applications, set **No Color Management**.

**Note:**  
 For information on supported platforms, see the website for the application in question.

Setting example of Adobe Photoshop CC

Open the **Print** dialog box.

Select **Color Management**, select **Printer Manages Colors** in **Color Handling**, and click **Print**.

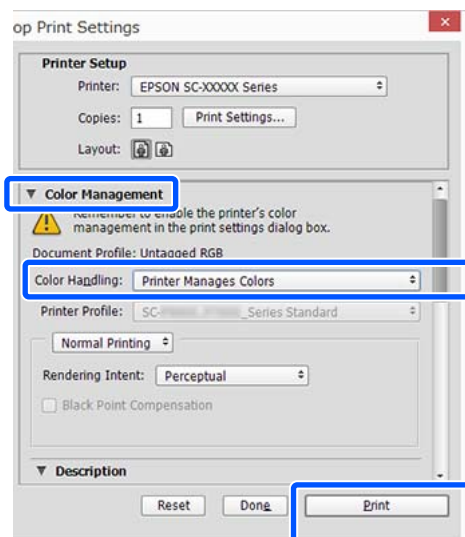

When using an application without a color management function, start from step 2.

- 2 Clear the **Simple Settings** check box in the **Print Quality** area on the **Printer Settings** tab of the printer driver and then select **ICM** from the **Select Target** list.

[“Basic Operating Procedures \(Windows\)” on page 46](#)

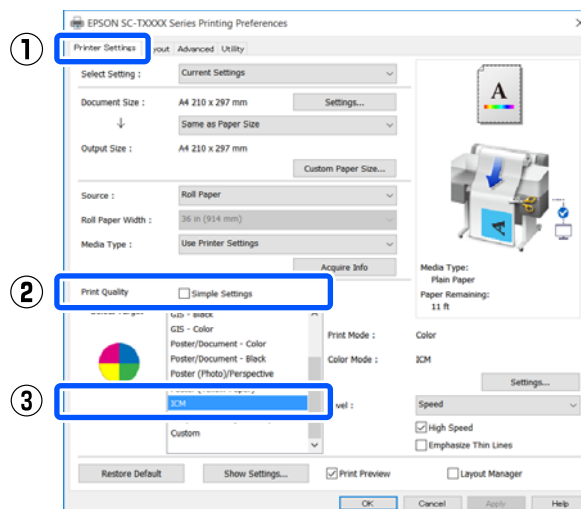

## Printing with the Printer Driver from Your Computer

### 3 Click Settings....

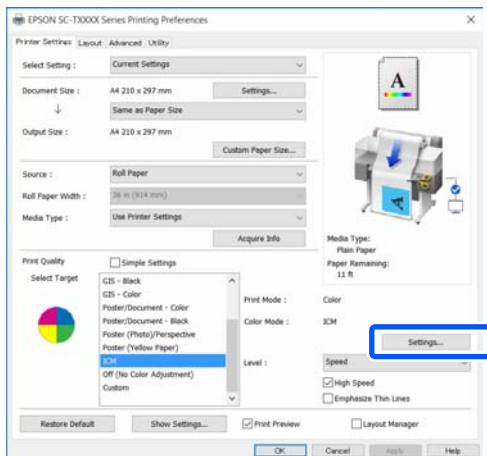

### 4 Select Host ICM in ICM Mode.

See the printer driver help for more details.

The printer profile corresponding to the **Media Type**\* selected on the **Printer Settings** tab is set automatically and is displayed in the **Printer Profile Description** area.

To change the profile, select the **Show all profiles** check box.

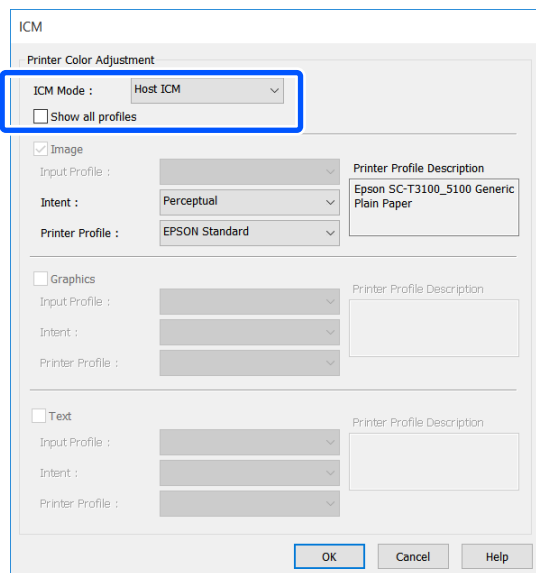

\*: If Source is selected on the Printer Settings tab, the paper type set on the printer is set automatically. Media Type becomes **Use Printer Settings**, and the paper type name is displayed on the right side.

### 5 Check other settings, and then start printing.

## Color Management Printing by ColorSync (Mac)

Use image data in which an input profile has been embedded. Also, the application must support ColorSync.

**Note:**

Depending on the application, color management printing by **ColorSync** may not be supported.

1 Disable the color management functions in the application.

2 Display the Print screen.

[“Basic Operating Procedures \(Mac\)” on page 52](#)

3 Select **Color Matching** from the list, and then click **ColorSync**.

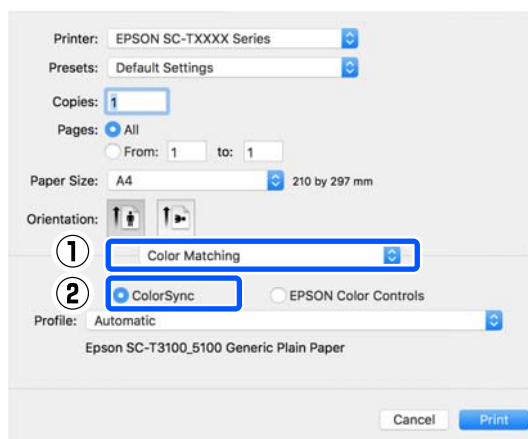

The printer profile corresponding to the currently selected paper type\* is specified automatically and displayed at the bottom of the profile area. To change the profile, select the desired profile from the **Profile** pull-down menu.

\*: It is set in the screen displayed by selecting Printer Settings from the list. If Source is selected, the paper type set on the printer is set automatically, and **Use Printer Settings** is displayed. The paper type name is displayed on the right side of it.

4 Check other settings, and then start printing.

## Printing with the Printer Driver from Your Computer

### Color Management Printing by Driver ICM (Windows Only)

The printer driver uses its own printer profiles to perform color management. You can use the following two color correction methods.

- ❑ Driver ICM (Basic)  
Specify one type of profile and intent for processing the entire image data.
- ❑ Driver ICM (Advanced)  
The printer driver distinguishes the image data into the **Image**, **Graphics**, and **Text** areas. Specify a different profile and intent for each of the three areas.

#### When using applications featuring a color management function

Make the settings for color processing using the application before making printer driver settings.

Depending on the type of the application, make the settings following the table below.

Adobe Photoshop CS3 or later  
 Adobe Photoshop Elements 6.0 or later  
 Adobe Photoshop Lightroom 1 or later

OS	Color Management Settings
Windows 8.1, Windows 8, Windows 7, Windows Vista	Printer Manages Colors
Windows XP (Service Pack 2 or later and .NET 3.0 or later)	
Windows XP (other than the above)	No Color Management

In other applications, set **No Color Management**.

**Note:**

For information on supported platforms, see the website for the application in question.

Setting example of Adobe Photoshop CC

Open the **Print** dialog box.

Select **Color Management**, select **Printer Manages Colors** in **Color Handling**, and click **Print**.

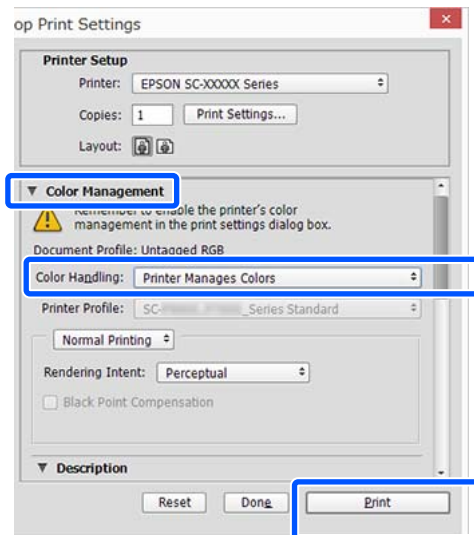

- 1 Clear the **Simple Settings** check box in the Print Quality area on the **Printer Settings** tab of the printer driver and then select **ICM** from the Select Target list.

[“Basic Operating Procedures \(Windows\)” on page 46](#)

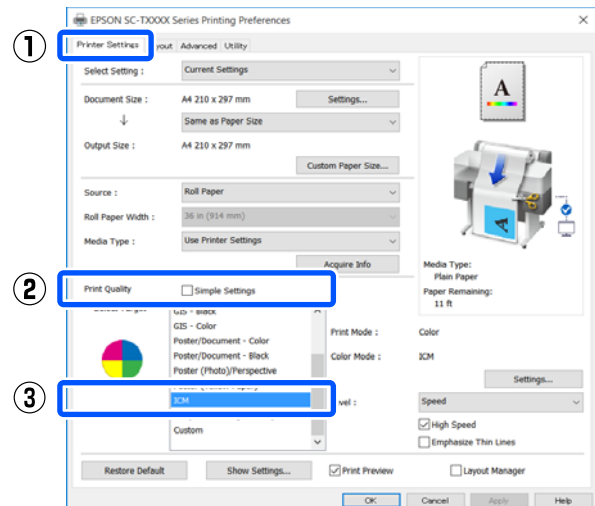

## Printing with the Printer Driver from Your Computer

### 2 Click Settings....

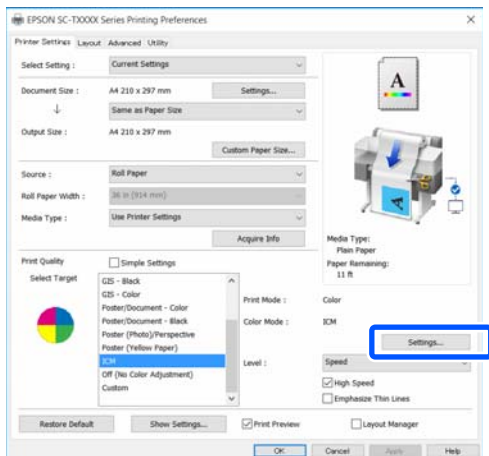

### 3 Select Driver ICM (Basic) or Driver ICM (Advanced) in ICM Mode of the ICM dialog box.



If you select **Driver ICM (Advanced)**, you can specify the profile and intent for each of image data such as photos, graphics data, and text data.

Intent	Explanation
Saturation	Keeps the current saturation unchanged and converts the data.
Perceptual	Converts the data so that a more visually natural image is produced. This feature is used when a wider gamut of color is used for image data.

Intent	Explanation
Relative Colorimetric	Converts the data so that a set of color gamut and white point (or color temperature) coordinates in the original data match their corresponding print coordinates. This feature is used for many types of color matching.
Absolute Colorimetric	Assigns absolute color gamut coordinates to the original and print data and converts the data. Therefore, color tone adjustment is not performed on any white point (or color temperature) for the original or print data. This feature is used for special purposes such as logo color printing.

### 4 Check other settings, and then start printing.

## Printing with the Printer Driver from Your Computer

# Multi-Page Printing (N-up)

Two or four consecutive pages can be printed on a single sheet.

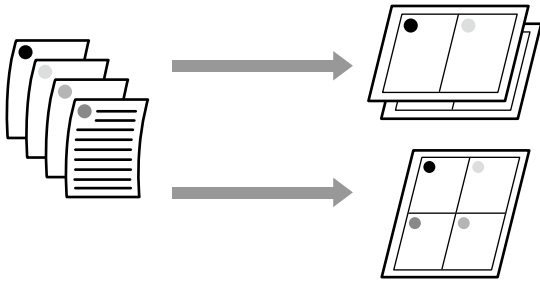

### Making Settings in Windows

**Note:**

In Windows, you can use the Reduce/Enlarge function (Fit to Page) to print the data on different sizes of paper.

[“Printing at Non-Standard Sizes” on page 64](#)

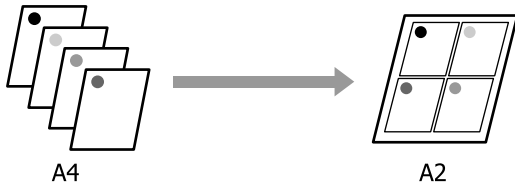

- 1 Display the Layout tab of the printer driver and select the **Page Layout** check box. Then, select **N-up** and click the **Settings** button.

[“Basic Operating Procedures \(Windows\)” on page 46](#)

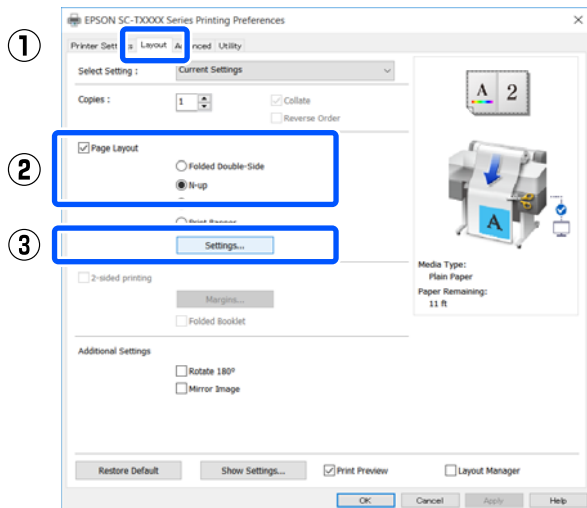

- 2 Set **Number of pages per sheet** and **Page Order** in the Print Layout dialog box.

If the **Print page frames** check box is selected, page frames are printed on each page.

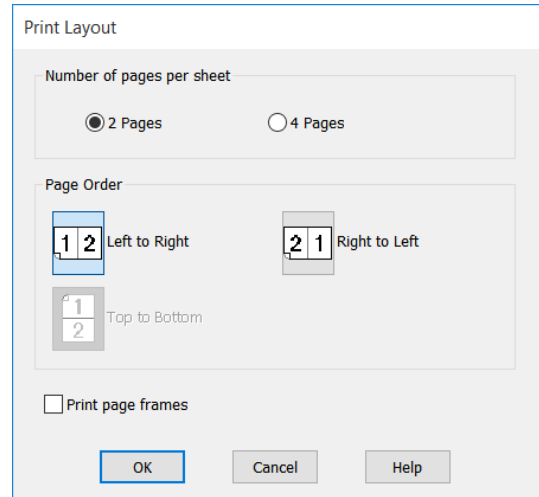

- 3 Check other settings, and then start printing.

### Settings in Mac

- 1 Display the Print dialog box, select **Layout** from the list, and specify the number of pages per sheet and so on.

[“Basic Operating Procedures \(Mac\)” on page 52](#)

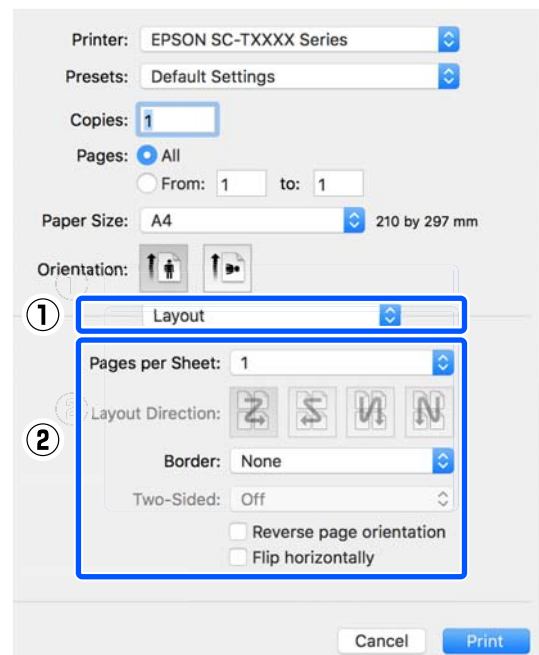



## Printing with the Printer Driver from Your Computer

**Note:**

You can print frames around arranged pages using the **Border** function.

2

Check other settings, and then start printing.

## Manual 2-Sided Printing (Windows Only)

This function is enabled only when Auto Sheet Feeder is selected in Source. It is not available when Roll Paper or Sheet is selected.

This function allows printing on both sides by turning over the paper after printing of the even pages finishes and then printing the odd pages.

### Notes on Using 2-Sided Printing

Observe the following points when performing 2-sided printing.

- Use paper compatible with 2-sided printing.
- Depending on the paper type and data to be printed, the ink may bleed through to the other side of the paper.
- Performing 2-sided printing continuously may cause the print quality to decline or a paper jam. If the print quality declines, reduce the ink density in the printer driver or print one sheet at a time.
- If 2-sided printing is performed continuously, the inside of the printer may become soiled with ink. If the paper is soiled from the rollers after printing, perform cleaning.  [“Smearing occurs on printed matter from the auto sheet feeder.” on page 148](#)

**Note:**

Paper can be further saved by performing 2-sided printing in combination with multi-page printing.

 [“Multi-Page Printing \(N-up\)” on page 79](#)

### Setting Procedures for Printing

1

Load the paper in the auto sheet feeder.

 [“Loading Paper in the Auto Sheet Feeder” on page 34](#)



### Printing with the Printer Driver from Your Computer

- 2 Display the Printer Settings tab of the printer driver and select **Auto Sheet Feeder** in Source.

[“Basic Operating Procedures \(Windows\)” on page 46](#)

- 3 Display the Layout tab of the printer driver and select the **2-sided printing** check box.

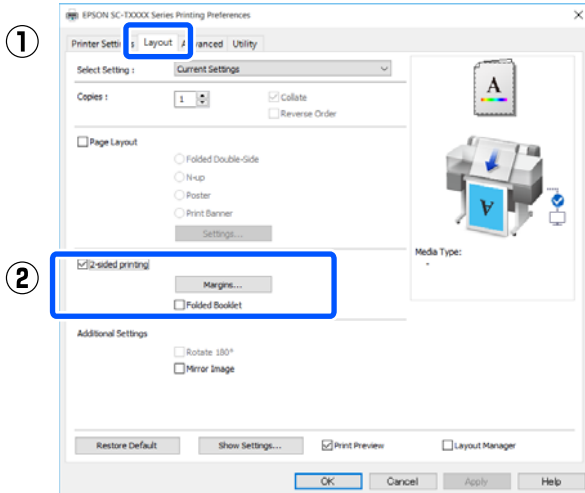

- 4 Check other settings, and then start printing.

- 5 When the guide screen appears after printing of the odd pages is finished, load the paper again following the instructions on the screen and then click **Resume**.

**Note:**

If you click **Margin Setting**, you can set **Binding Edge** and **Binding Margin**. Perform a test print because the set binding margin width and the actual print result may differ depending the application used.

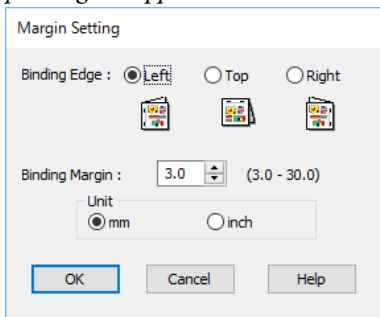

Selecting the **Folded Booklet** check box enables printing to make a booklet. In the example in the figure below, the pages that will be on the inside when the paper is folded into two (pages 2, 3, 6, 7, 10, and 11) are printed first.

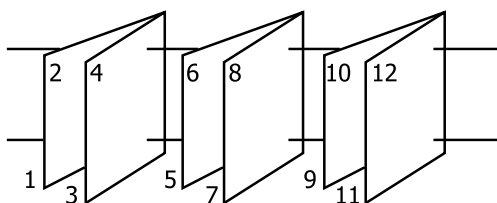

Printing with the Printer Driver from Your Computer

# Folded 2-Sided Printing (Windows only)

Two consecutive pages can be printed on a single sheet. The second page is flipped 180° and printed adjacent to the first page, allowing the paper to be folded to make a 2-sided document.

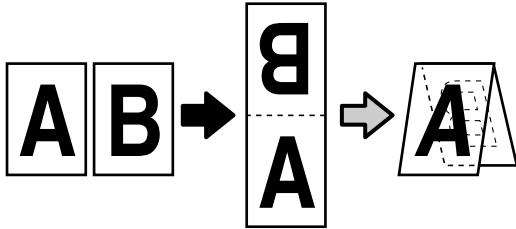

- 1 Display the Layout tab of the printer driver and select the **Page Layout** check box. Then, select **Folded Double-Side** and click the **Settings...** button.

[📖 “Basic Operating Procedures \(Windows\)” on page 46](#)

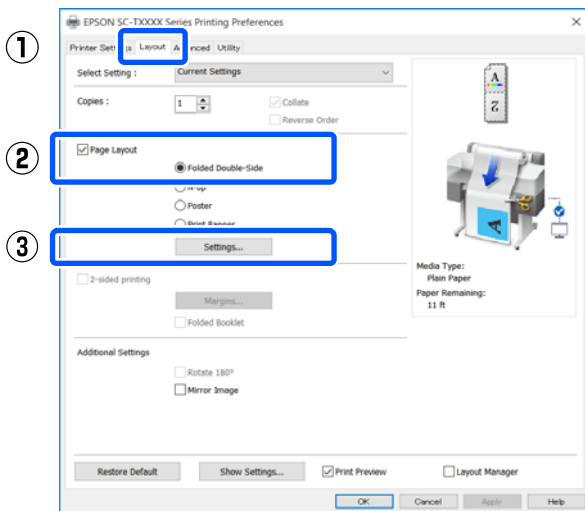

- 2 Set **Binding Edge** and **Binding Margin** in the **Folded Double-Side Setting** dialog box.

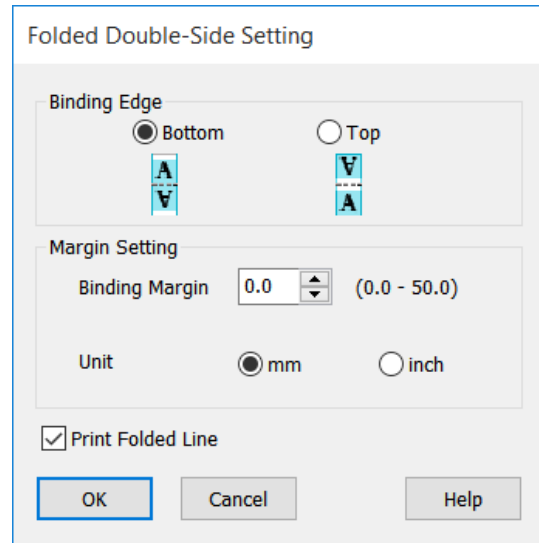

- 3 Check other settings, and then start printing.

**Printing with the Printer Driver from Your Computer**

# Poster Printing (Windows Only)

A single page can be printed across multiple sheets. The sheets can then be joined together to form large posters (up to 16 times the original size).



**1** Display the Layout tab of the printer driver and select the **Page Layout** check box. Then, select **Poster** and click the **Settings...** button.

[“Basic Operating Procedures \(Windows\)” on page 46](#)

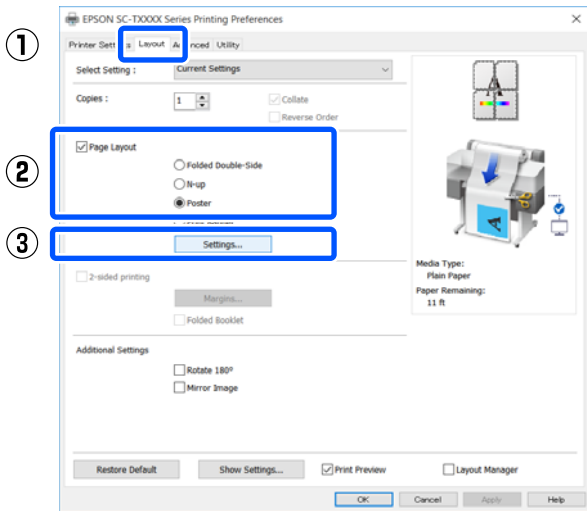

**2** Set **Number of panels** in the Poster dialog box.

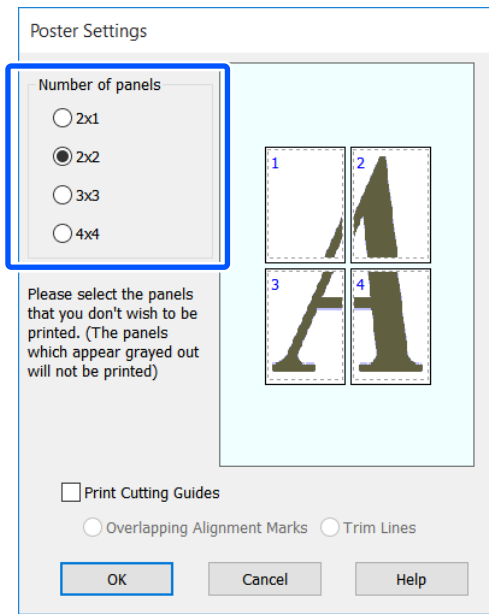

**3** If you want to print marks to serve as a guide when joining together paper printed with poster printing, select the **Print Cutting Guides** check box.

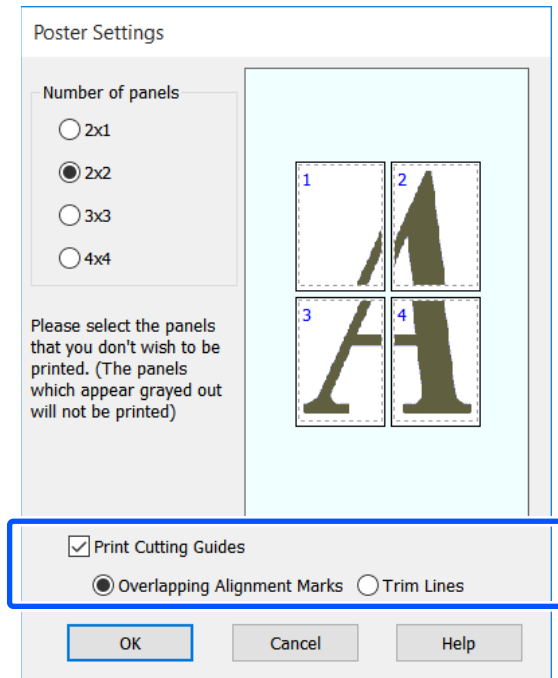

### Overlapping Alignment Marks

Prints guides for joining the paper with overlapping. The finished size is smaller only for the overlapping portions.

## Printing with the Printer Driver from Your Computer

### Print page frames

Prints frames for joining the paper without overlapping.

- 4 Check other settings, and then start printing.

### Joining poster sheets when multi-page printing

If **Overlapping Alignment Marks** is selected, join guides (indicated by the lines drawn through and around the X marks in the illustration below) will be printed on each sheet.

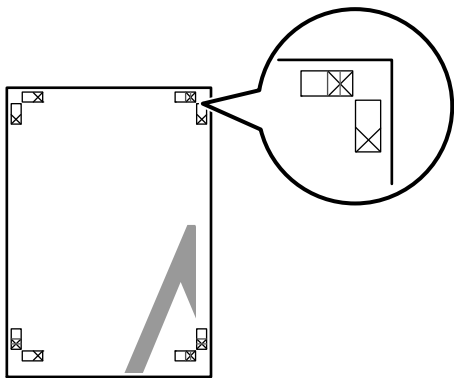

**Note:**

*If the output is in color, the join guides will be in blue and the cut guides in red; otherwise, all the guides will be printed in black.*

The following section describes how to join four printed pages together.

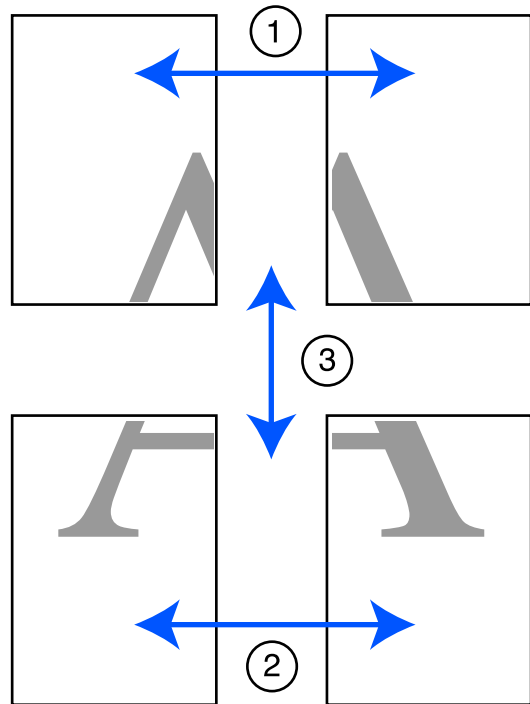

**Printing with the Printer Driver from Your Computer**

- 1 Ready the two top sheets and trim the excess from the left sheet by cutting along the line joining the two join guides (the centers of the X marks).

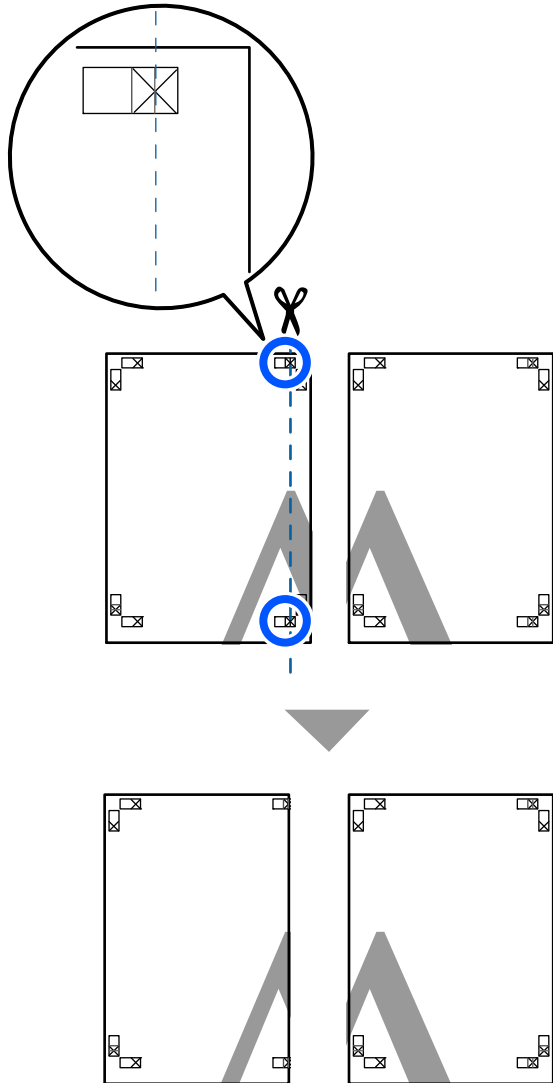

- 2 Lay the upper left sheet on top of upper right sheet. Lineup the X marks as shown in the illustration below, and temporarily fasten them using an adhesive tape on the back.

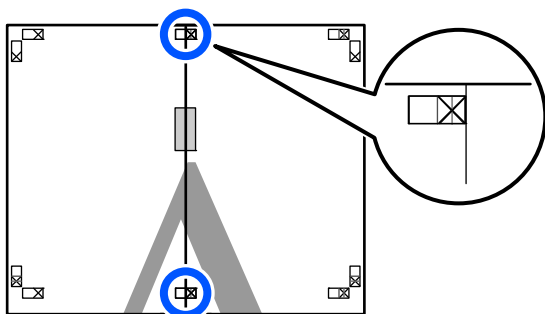

- 3 With the two sheets overlapping, trim the excess by cutting along the line joining the two cut guides (the lines to the left of the X marks).

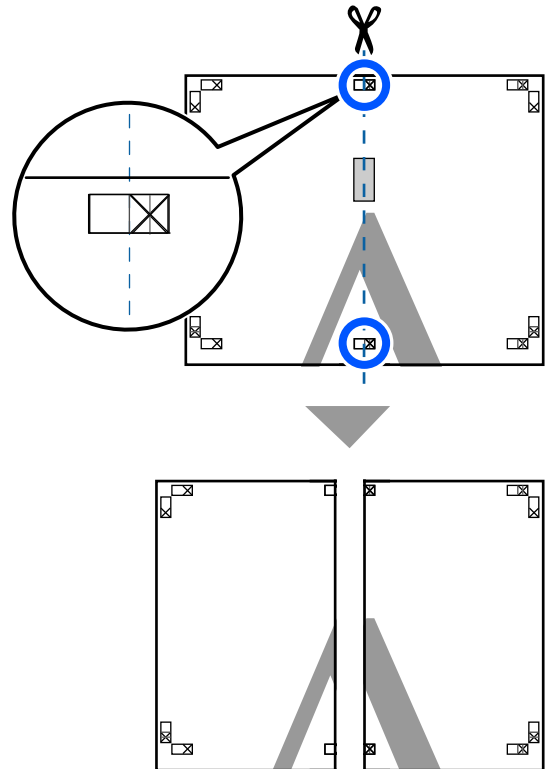

- 4 Rejoin the two sheets. Use an adhesive tape to stick the backs of the sheets together.

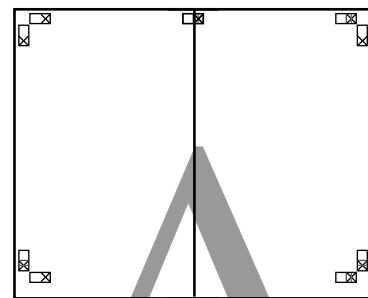

- 5 Repeat steps 1 to 4 for the lower two sheets.

**Printing with the Printer Driver from Your Computer**

- 6** Trim the bottom from the upper sheets by cutting along the line joining the two guides (the lines above the X marks).

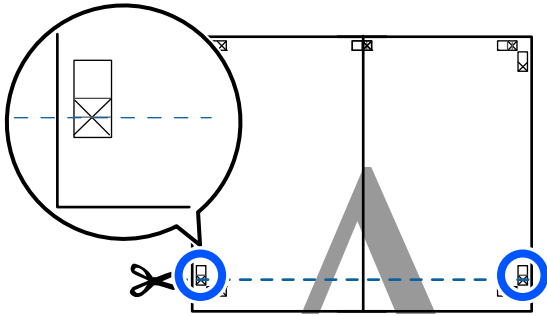

- 7** Lay the upper sheet on top of the lower sheet. Lineup the X marks as shown in the illustration below, and temporarily fasten them using an adhesive tape on the back.

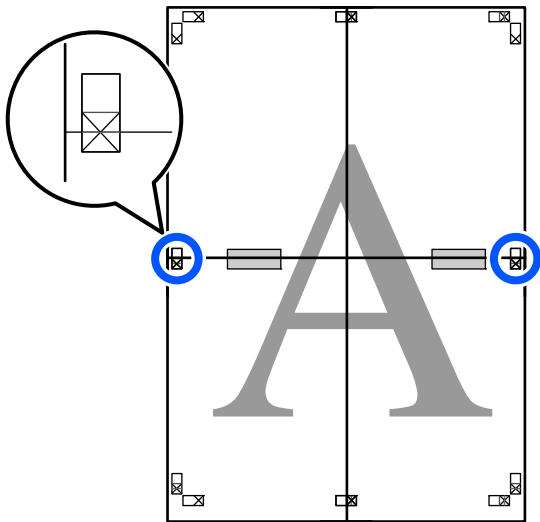

- 8** With the two sheets overlapping, trim the excess by cutting along the line joining the two cut guides (the lines above the X marks).

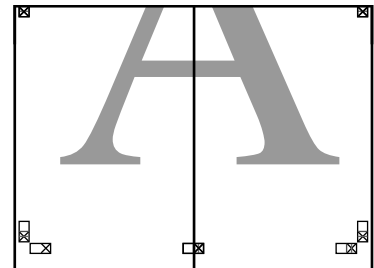
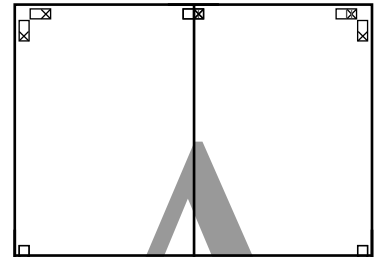
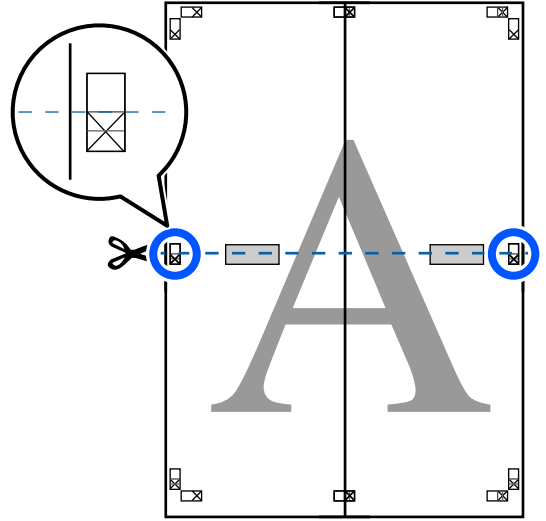

### Printing with the Printer Driver from Your Computer

- 9** Join the upper and lower sheets together.  
Use an adhesive tape to stick the backs of the sheets together.

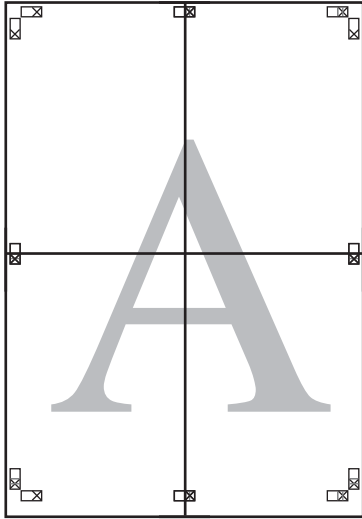

- 10** After joining all the sheets, trim off the borders by cutting along the cut guides (outside the X marks).

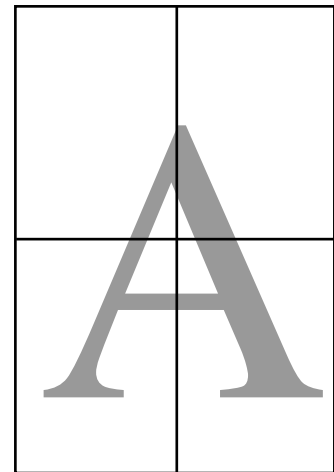
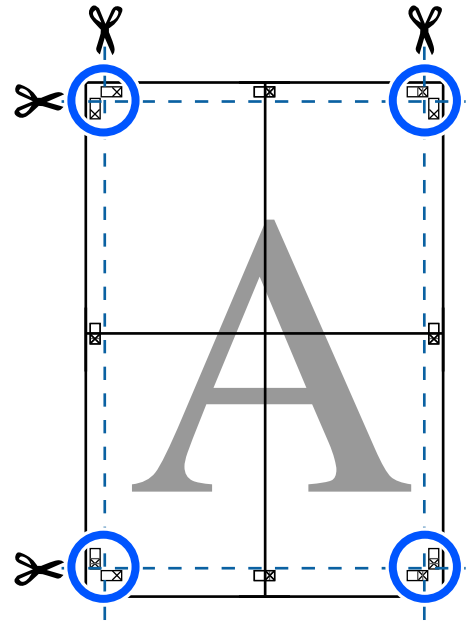

Printing with the Printer Driver from Your Computer

# Printing Multiple Documents (Layout Manager) (Windows Only)

Documents created in different applications can be printed together in your choice of layout. This allows you to improve print work efficiency and conserve paper.

## Sample Multi-Document Layout

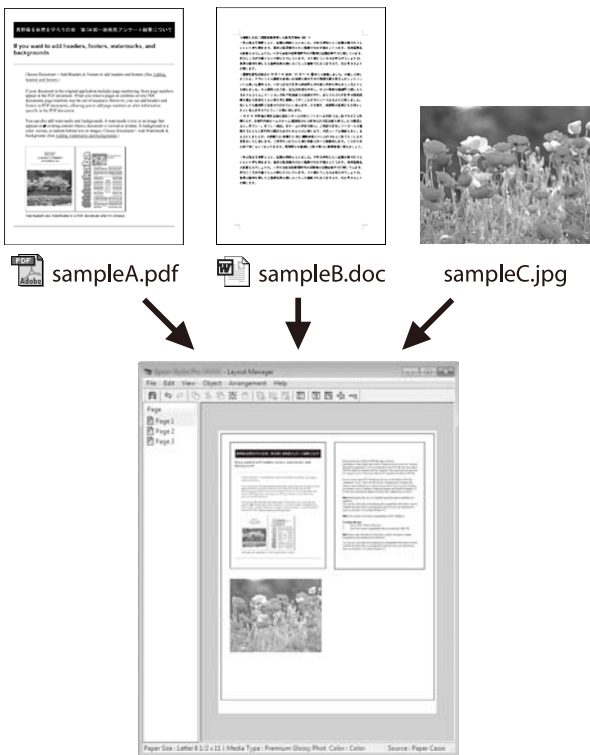

## Sample Free Vertical/Horizontal Layout

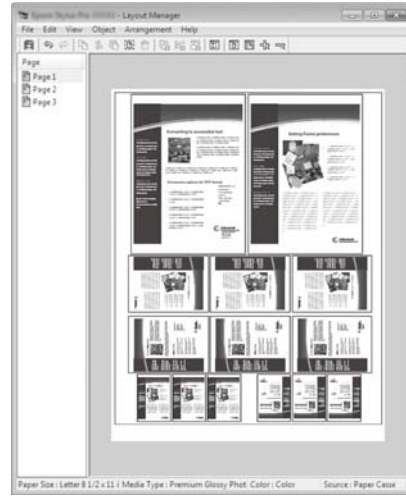

## Setting Procedures for Printing

- 1 Open the file you want to print in your application.
- 2 Select the **Layout Manager** check box on the Printer Settings tab of the printer driver and check that the size set in the application is displayed in Document Size.

[“Basic Operating Procedures \(Windows\)” on page 46](#)

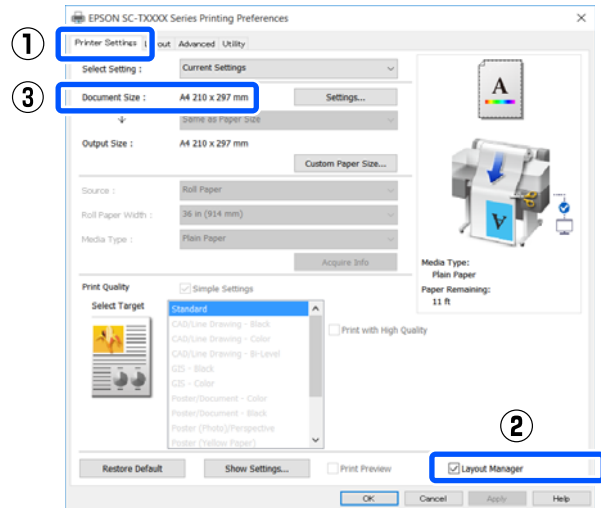

**Note:**  
*Document Size* is the size of the document to be placed on the Layout Manager screen. The actual printing paper size is set in the screen in Step 6.



## Printing with the Printer Driver from Your Computer

- Click **OK**. When printing from an application, the Layout Manager screen opens.

The print data is not printed, but one page is placed on the paper of the Layout Manager screen as one object.

- Leaving the Layout Manager screen open, repeat steps 1 to 3 until all the print data has been added to the layout.

The objects are added to the Layout Manager screen.

- Arrange the objects on the Layout Manager screen.

Objects can be moved or resized by dragging as well as rearranged or rotated using the tool buttons or the options in the **Object** menu.

The overall size and placement of the objects can be changed using the **Preferences** and **Arrangement** options in the **File** menu.

See the Layout Manager screen help for more details on each function.

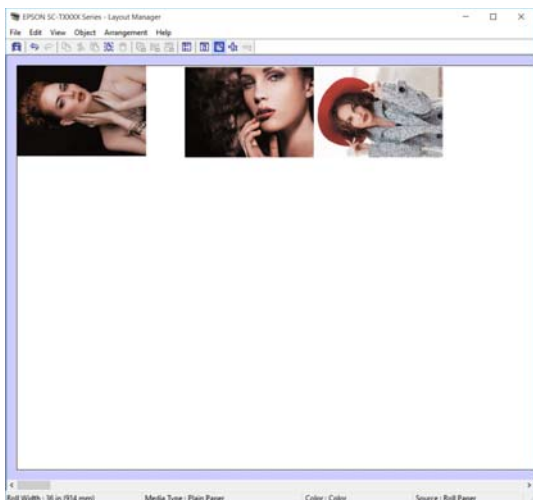

- Click **Properties** in the **File** menu and set the print settings in the printer driver dialog box.

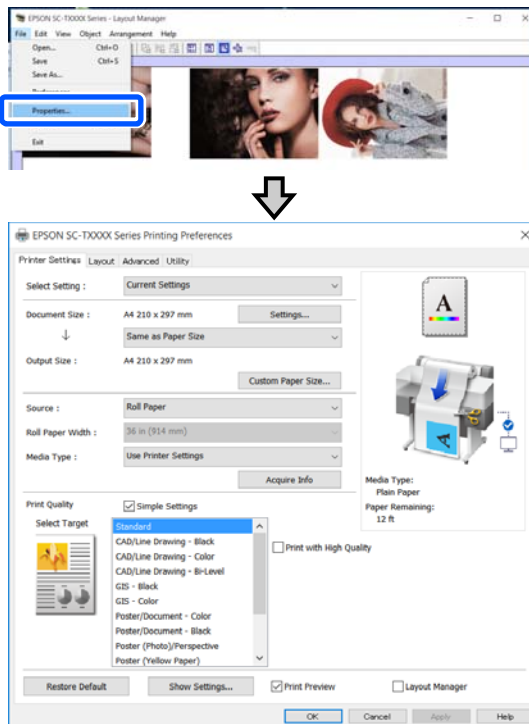

Set **Print Quality** in the **Media Settings** dialog box.

- Click the **File** menu in the Layout Manager screen, and then click **Print**.

Printing starts.

## Saving and Recalling Settings

The layout and setting information on the Layout Manager screen can be saved as a file. If you need to close your application in the middle of a job, you can save it to a file and then open it later to continue your work.

### Saving

- Click the **File** menu on the Layout Manager screen, and then click **Save As...**
- Enter the file name, select the location, and then click **Save**.
- Close the Layout Manager screen.

## Printing with the Printer Driver from Your Computer

### Opening saved files

- 1 Right-click the printer icon (  ) on the Windows taskbar, and then click **Layout Manager** in the displayed menu.

The Layout Manager screen appears.

**Note:**

**When the printer icon is not displayed on the Windows taskbar**

Open the **Utility** tab of the printer driver and click the **Monitoring Preferences**. Select the **Register the shortcut icon to the taskbar** check box in the **Monitoring Preferences** dialog box.

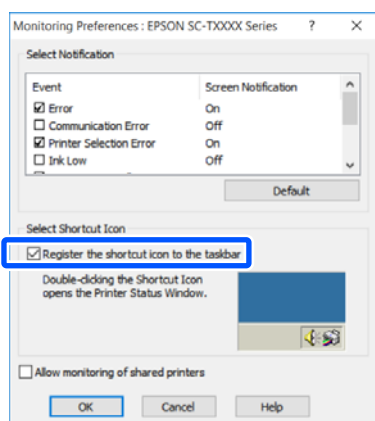

- 2 Click **Open** in the **File** menu on the Layout Manager screen.
- 3 Select the location and open the required file.

## Printing Using the HP-GL/2 or HP RTL Mode from a Computer

# Printing Using the HP-GL/2 or HP RTL Mode from a Computer

The printer can emulate\* HP-GL/2 (compatible with HP Designjet 750C) and HP RTL. This section describes the settings of the printer and the settings in the CAD application for printing while emulating.

\* Not all functions are supported. If you will use an untested application, test its output in advance.

For a list of applications that have been tested, visit the Epson website at <http://www.epson.com>.

### Important:

*The printer may not perform as expected if the size of the data to be printed is extremely large.*

### Note:

*CAD drawings can also be printed using the CAD/ line drawing mode of the supplied printer driver. We recommend printing from the printer driver when you want to print with better image quality.*

 ["Printing CAD Drawings" on page 57](#)

## Printer Settings

Change the printer settings for printing in the HP-GL/2 or HP RTL mode as necessary in the control panel of the printer. The printer settings include basic print settings such as the paper source and margins (Universal Print Settings) and HP-GL/2 specific settings such as palette settings (HP-GL/2 Unique Settings).

## Basic Print Settings

- 1 Touch **Settings - General Settings - Printer Settings - Universal Print Settings** from the Home screen.
- 2 Check **Paper Source** and change the setting if necessary.  
  
The default setting is Roll Paper. When HP-GL/2 or HP RTL print data is sent, an error occurs if paper is not loaded for the paper source set here.
- 3 Check the other items and make changes if necessary.  
  
See the following for more details on Universal Print Settings items.  
  
 ["General Settings - Printer Settings" on page 117](#)

## HP-GL/2 Specific Print Settings

If you want to change HP-GL2 specific settings such as rotating print data, merging lines, and changing the Define Palette set in the application, use the following procedure.

- 1 Touch **Settings - General Settings - Printer Settings - HP-GL/2 Unique Settings** from the Home screen.
- 2 Touch and change the settings of the desired items.  
  
See the following for more details on HP-GL/2 Unique Settings items.  
  
 ["General Settings - Printer Settings" on page 117](#)

## Printing Using the HP-GL/2 or HP RTL Mode from a Computer

**Note:**

**When HP-GL/2 or HP RTL printing is not performed properly**

The printer automatically determines whether normal printing from the printer driver or emulation printing of HP-GL/2 or HP RTL from the sent print data and then switches the print mode accordingly. If mode switching is not performed correctly and printing is not performed properly, configure the setting as follows.

- ❑ When the computer and printer are connected via USB  
Select **Settings - General Settings - Printer Settings - Printing Language - USB** from the Home screen and then change the setting from **Auto** to **HP-GL/2**.
- ❑ When the computer and printer are connected via a network  
Select **Settings - General Settings - Printer Settings - Printing Language - Network** from the Home screen and then change the setting from **Auto** to **HP-GL/2**.

To print from the printer driver as usual after HP-GL/2 or HP RTL finishes, return the setting to **Auto**.

- ❑ SC-T3100 Series/SC-T3100N Series:  
HP Designjet 750C C3195A

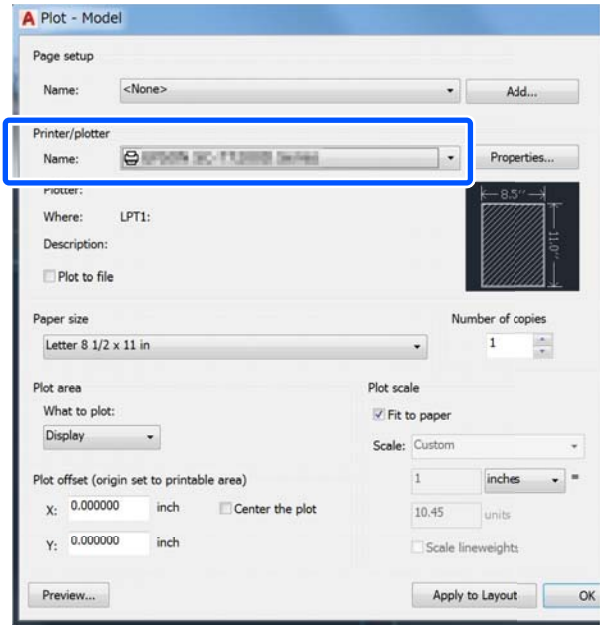

## CAD Application Settings

Set the output device as follows according to your model. This explanation uses AutoCAD 2018 as an example.

- 1 Click **Plot**.

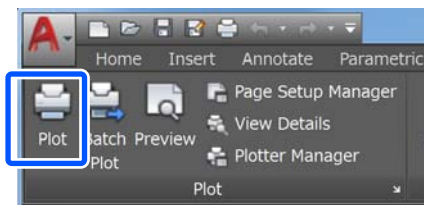

- 2 Set the plotter in **Printer/plotter**.

- ❑ SC-T5100 Series/SC-T5100N Series:  
HP Designjet 750C C3196A

## Changing the Network Connection Methods

# Changing the Network Connection Methods

The printer can connect to a wired LAN or a wireless LAN. Furthermore, it also supports Wi-Fi Direct (Simple AP) which allows a smart device or other device to directly connect wirelessly with the printer even when there is no wired LAN or wireless LAN environment.

The printer cannot connect to a wired LAN and wireless LAN at the same time. A Wi-Fi Direct connection is possible regardless of whether or not the printer is connected to a network.

This section describes the procedures to use to switch the connection method.

**Note:**

See the *Administrator's Guide (online manual)* for details on the network settings.

## Switching to Wired LAN

- 1 Touch  on the Home screen.

**Note:**

The shape and color of the icon differ depending on the connection status.

 ["Home screen operations" on page 13](#)

- 2 Touch **Description**.
- 3 Touch **Wired LAN Connection Method**.
- 4 Touch **Start Setup**.  
The process to disable the wireless LAN connection with the access point starts. Wait until the **The Wi-Fi connection is disabled** message appears.

- 5 Connect your router and the printer with a LAN cable.

See the following for the location of the printer's LAN port.

 ["Back" on page 11](#)

## Switching to Wireless LAN

The SSID (network name) and password of the access point to which the printer is to be connected are required. Confirm them in advance. The printer can be connected to a wireless LAN while the LAN cable is still connected.

**Note:**

If your access point supports WPS (Wi-Fi Protected Setup), the printer can be connected using **Push Button Setup(WPS)** or **PIN Code Setup(WPS)** without using an SSID and password.

 ["General Settings - Network Settings" on page 127](#)

- 1 Touch  on the Home screen.

**Note:**

The shape and color of the icon differ depending on the connection status.

 ["Home screen operations" on page 13](#)

- 2 Touch **Router**.
- 3 Touch **Start Setup**.  
Details of the wired LAN connection status are displayed.
- 4 Touch **Change to Wi-Fi connection**., check the displayed message, and touch **Yes**.
- 5 Touch **Wi-Fi Setup Wizard**.
- 6 Select the desired SSID.  
If the desired SSID is not displayed, touch **Search Again** to update the list. If it is still not displayed, touch **Enter Manually** and directly enter the SSID.

## Changing the Network Connection Methods

**7** Touch **Enter Password** and enter the password.

**Note:**

- Differentiate between uppercase and lowercase when entering the password.
- If the SSID was entered directly, set **Password** to **Available** before entering the password.

**8** When input is finished, touch **OK**.

**9** Check the settings and then touch **Start Setup**.

**10** Touch **OK** to finish the procedure.

If the connection fails, select **Print Check Report** to print a network connection check report. You can check the measure to take in the report.

**11** Close the Network Connection Settings screen.

## Directly Connection Wirelessly (Wi-Fi Direct)

A direct connection with the printer can be established temporarily when, for example, the printer is not connected to a network or you do not have permission to log on to the network.

Wi-Fi Direct is disabled by default. The following describes the procedure from enabling Wi-Fi Direct to connecting.

**Note:**

The printer can connect with up to four smart devices or computers at the same time. If you want to connect another device when there are already four devices connected, disconnect the connection with the printer from an already connected device.

**1** Touch  on the Home screen.

**Note:**

The shape and color of the icon differ depending on the connection status.

 [“Home screen operations” on page 13](#)

**2** Touch **Wi-Fi Direct**.

When Wi-Fi Direct is already enabled, the network (SSID), password, number of connected devices, etc. are displayed. Proceed to step 5.

**Note:**

When any of the displayed network (SSID), device name, etc. is partially not visible because it is cut off at the right edge of the screen, touch the corresponding item to display the entire setting value.

**3** Touch **Start Setup**.

**4** Touch **Start Setup**.

Wi-Fi Direct is enabled and the network (SSID), password are displayed.

**5** Open the Wi-Fi setting screen on the device you want to connect with the printer, select the SSID displayed on the screen of the printer, and enter the password just as it is displayed on the screen.

**6** When a connection is established, touch **Close** to finish the procedure.

**7** Touch **Close** on the screen of the printer to close the network connection settings screen.

When the printer driver is installed on the connected device, you can print using the printer driver.

You can print using AirPrint from a Mac computer or iOS device.

 [“Printing Using AirPrint” on page 95](#)

**Note:**

When you turn off the power of the printer, the connections with connected devices are all disconnected. To reconnect after turning the printer back on, perform the procedure again from step 1.

## Printing Using AirPrint

# Printing Using AirPrint

You can easily print wirelessly using AirPrint from an iPhone, iPad, or iPod touch running the latest iOS or from one of the latest Mac computers.

This section describes the procedure to print from a smart device.



**Note:**

*Printing such as the following is not possible with AirPrint.*

- Printing by automatically fitting the document to the roll paper width*
- Printing by automatically enlarging or reducing to fit the output paper size*
- Setting a print quality suitable for the print target*

*For such printing, please use the printer driver.*

[🔗 “How to Select the Dedicated Printer Driver for This Printer” on page 54](#)

- 1** Connect the smart device and printer via wireless LAN or Wi-Fi Direct.

See the following for more details.

[🔗 “Switching to Wireless LAN” on page 93](#)

[🔗 “Directly Connection Wirelessly \(Wi-Fi Direct\)” on page 94](#)

- 2** Load the paper in the printer.

- 3** Open the document or photo to be printed on your smart device.

- 4** Tap the share icon to display the print option.

- 5** Tap the printer icon or **Print**.

**Note:**

*The print option is not displayed for an application that does not support AirPrint. Check whether it is supported in the help or other documentation of the application.*

- 6** Tap **Select Printer** and select the printer from the displayed list.

- 7** Tap **Print** to start printing.

**Making Enlarged Copies with an A3 or A4 Scanner**

# Making Enlarged Copies with an A3 or A4 Scanner

Connecting an Epson A3 or A4 scanner to the printer makes creating enlarged copies a snap; no computer is required.

**Supported scanners**

- DS-530
- DS-6500
- DS-60000

Check the Epson website for the latest information on supported scanners.

<http://www.epson.com>

**Supported Sizes**

Document Size*1	Output Size
5 x 7 inch	A2
Letter	US C (17x22in)
A5	JIS B2
B5	US D (22x34in)
A4	A1
B4	JIS B1*3
A3	US E (34x44in)*3
User-Defined*2	A0*3
	User-Defined*4

\*1 Differs depending on the specifications of the scanner to be connected.

\*2 89 to 297 mm wide (216 mm when A4 scanner)

\*3 Not supported by SC-T3100 Series/SC-T3100N Series.

\*4 89 to 914 mm wide (up to 610 mm for SC-T3100 Series/SC-T3100N Series)

**Supported paper**

Roll paper only. Enlarged copying to cut sheet is not possible.

**Unsupported paper types**

The following paper cannot be used for enlarged copying.

- Enhanced Adhesive Synthetic Paper
- Enhanced Low Adhesive Synthetic Paper

[“Epson Special Media Table” on page 157](#)

## Connecting the Scanner

- 1** Ready both the printer and the scanner.  
For information on setting up the scanner, see the documentation supplied with the scanner.
- 2** Turn the printer and scanner off.
- 3** Connect the scanner to the printer using the USB cable supplied with the scanner.

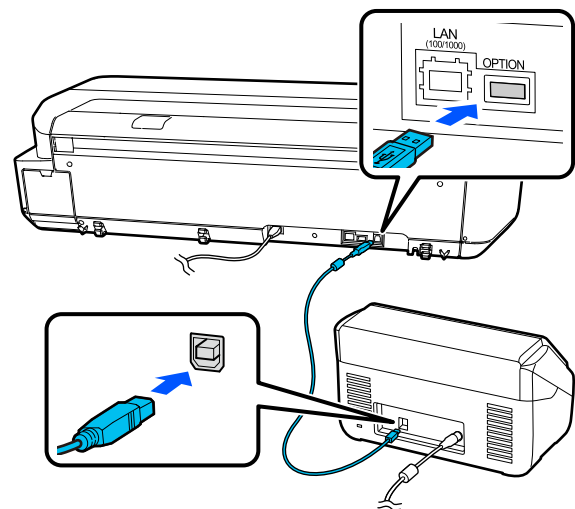

**! Important:**

*Connect the scanner directly to the printer. Enlarged copies are only available when the scanner is connected directly to the printer.*



## Making Enlarged Copies with an A3 or A4 Scanner

# Making Enlarged Copies

- 1 Turn the printer and scanner on.  
The devices may be turned on in any order.
- 2 Load roll paper supported by the enlarged copying function into the printer.  
[“Loading Roll Paper” on page 28](#)
- 3 Place the document on the scanner glass or in the auto document feeder (ADF).  
[“Placing Documents in the Scanner” on page 97](#)  
For information on using the scanner, see the documentation supplied with the device.
- 4 Touch **Enlarged Copy** on the Home screen.  
The enlarged copy dialog box is displayed.

**Note:**

If **Enlarged Copy** is not displayed on the Home screen, check the following.

- Are the connectors of the USB cable connecting the printer and scanner inserted firmly?
- Is the power of the scanner on?
- Is the scanner a model that supports enlarged copying?

- 5 Select the size of the document loaded in the scanner in **Original Size** and set the enlargement setting in **Reduce/Enlarge**.  
If you set **Auto Fit Page to On**, printing is performed by automatically enlarging to fit the width of the roll paper loaded in the printer.

**Important:**

The image quality may decline or streaks may appear depending on the document or magnification.

If streaks appear, try performing paper adjustment.

[“Optimizing Paper Settings \(Media Adjust\)” on page 43](#)

If the problem is not resolved, refer to the scanner manual and then clean the inside of the scanner.

**Note:**

If you touch ☆ (Presets), you can assign a name to frequently used copy settings and then register them to Presets.

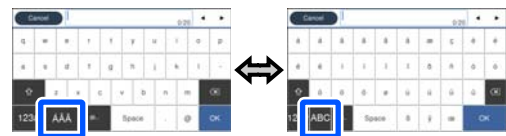

The screen for entering a name can be switched as shown below with the button marked.



Also, each touch of the following bottom left icon switches the input method as follows.

ABC: Enters alphabet letters

123#: Enters numbers and symbols

- 6 Touch the numeric value for the number of copies and then enter the number of copies in the keypad screen.
- 7 Touch  to start copying.  
Copying can also be started by touching the  button of the scanner.

## Placing Documents in the Scanner

Failure to observe the following precautions when placing the original in the scanner may result in reduced print quality or scanning failures.

### Making Enlarged Copies with an A3 or A4 Scanner

- ❑ DS-530 is a scanner that scans both sides simultaneously but it cannot scan both sides of the document with enlarged copying. Place the side you want copying facing downward in the ADF.
- ❑ Be sure to insert the original in landscape (wide) orientation.

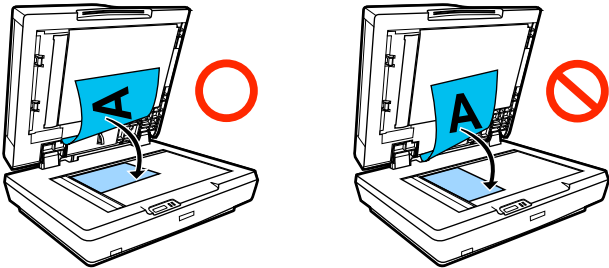

- ❑ If there are documents both on the glass and in the ADF, the document in the ADF will be scanned.  
Remove documents from the ADF before placing a document on the glass.
- ❑ The ADF can not be used when:
  - ❑ When **JIS B1** or **A0** is selected for Reduce/Enlarge and multiple copies will be made
  - ❑ The original is printed on thick stock (e.g., postcards or photographs)
- ❑ When multiple copies are made from an original placed on the glass, the original may be scanned once for each copy.  
Wait until all the copies have been printed before opening the scanner cover.
- ❑ Use the ADF to scan multi-page documents.
- ❑ If multiple copies are set for scanning multiple sheets continuously, the copies will be printed on a page basis as shown below.  
Example: Order in which pages are output when the printer is used to make two copies of a two page document

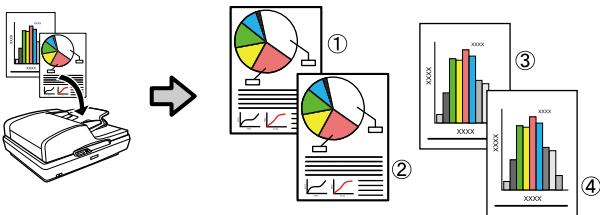

## Using the Menu

# Using the Menu

## Menu List

The items and options available in the menu are described below. See the reference pages for more details on each item.

### Paper Setting

The Paper Setting menu is displayed if paper is loaded.

Details of each item [↗](#) “Paper Setting menu” on page 109

Settings item	Settings value
Roll Paper	
Remove	Display the removal method
Feed/Cut Paper	Backward, Forward, Cut
Media Adjust	Start
Advanced Media Setting	
Platen Gap	1.6, 2.1, 2.6 (Displayed when in Paper Type, Custom Paper is selected.)
Top/Bottom Margins	Standard, Top 3 mm/Bottom 3 mm, Top 15 mm/Bottom 15 mm, Top 45 mm/Bottom 15 mm
Back Tension	Auto, Standard, High, Extra High
Drying Time	
Drying Time per Pass	0 to 10.0 sec
Drying Time per Page	0 to 60 min
Auto Cut	On, Off
Manage Remaining Amount	
Setup	On, Off
Remaining Amount	5.0 to 150.0 m
Remaining Alert	1.0 to 15.0 m

### Using the Menu

Settings item	Settings value
Change Paper Type	
Paper Type	
Plain paper	Display supported paper types
Coated Paper(Generic)	
Premium Glossy Sheet	
Others	
Auto Sheet Feeder	
Media Adjust	Start
Change Paper Type/Paper Size	
Paper Type	
Plain paper	Display supported paper types
Coated Paper(Generic)	
Premium Glossy Sheet	
Others	
Paper Size	Display supported paper sizes
Cut Sheet(1 sheet)	

### Using the Menu

Settings item	Settings value
Remove	Eject paper
Media Adjust	Start
Change Paper Type/Paper Size	
Paper Type	
Plain paper	Display supported paper types
Coated Paper(Generic)	
Premium Glossy Sheet	
Others	
Paper Size	
A Series	Display supported paper sizes
US-ANSI	
US-ARCH	
B Series (ISO)	
B Series (JIS)	
Others	
User-Defined	Display paper size input screen

### Printer Status

Details of each item [☞ “Printer Status menu” on page 114](#)

Settings item	Settings value
Supply Status	Display approximate remaining amounts, as well as product number of consumables
Message List	Display list of messages communicating printer status
Firmware Version	Display firmware version
Print Status Sheet	
Configuration Status Sheet	Print

## Using the Menu

### Settings

Settings item	Settings value
General Settings	
Basic Settings (Details of each item <a href="#">↗</a> "General Settings - Basic Settings" on page 115)	
LCD Brightness	1 to 9
Sound	
Mute	On, Off
Normal Mode	
Button Press	0 to 10
Error Notice	0 to 10
Sound Type	Pattern1, Pattern2
Sleep Timer	1 to 210 minutes
Power Off Timer	Off, 30minutes, 1h, 2h, 4h, 8h, 12h
Circuit Breaker Interlock Startup	On, Off
Date/Time Settings	
Date/Time	Date: yyyy.mm.dd, mm.dd.yyyy, dd.mm.yyyy Time: 12h, 24h
Time Difference	-12:45 to +13:45 (15 minute increments)
Language	Display supported languages
Operation Time Out	On, Off
Keyboard	QWERTY, AZERTY, QWERTZ
Length Unit	m, ft / in

### Using the Menu

Settings item	Settings value
Printer Settings (Details of each item <a href="#">↗</a> "General Settings - Printer Settings" on page 117)	
Paper Source Settings	
Error Notice	
Paper Size Notice	On, Off
Paper Type Notice	On, Off
Roll Paper Setup	
Detect Paper Meandering	On, Off
Print Cutting Guideline	On, Off
After-Print Options	Hold Paper, Eject Paper
Custom Paper Setting (Custom paper types 01 to 10 are displayed, and touching any of these will display settings items.)	
Change Name	Registered name input screen
Change Reference Paper	
Plain paper	Display supported paper types
Matte Paper	
Photo Paper	
CAD	
Others	
Advanced Media Setting	
Platen Gap	1.6, 2.1, 2.6
Top/Bottom Margins	Standard, Top 3 mm/Bottom 3 mm, Top 15 mm/Bottom 15 mm, Top 45 mm/Bottom 15 mm
Back Tension	Auto, Standard, High, Extra High
Drying Time	
Drying Time per Pass	0.0 to 10.0 sec
Drying Time per Page	0.0 to 60 min
Auto Cut	On, Off
Restore Default	Yes, No
Printing Language	
USB	Auto, HP-GL/2
Network	Auto, HP-GL/2

### Using the Menu

Settings item	Settings value
<b>Universal Print Settings</b>	
Paper Source	Roll Paper, Auto Sheet Feeder, Cut Sheet(1 sheet)
Quality	Standard, Speed, Fine, Super Fine
Color Mode	Color, Black/White
Page Margins option	Clip By Margins, Oversize
Page Margin	3 mm, 5 mm
Smoothing	On, Off
<b>Base Output Size</b>	
Auto	-
A Series	Display supported paper sizes
US-ANSI	
US-ARCH	
B Series (ISO)	
B Series (JIS)	
Others	
User-Defined	
Resolution	Standard, 300dpi, 600dpi, 1200dpi
Color Mode (Common)	EPSON Standard (sRGB), Business Graphics, GIS, Line Drawing, Off (No Color Management)
<b>HP-GL/2 Unique Settings</b>	
Rotate	0°, 90°, 180°, 270°
Origin Setup	Left Edge, Center
Mirror Image	On, Off
Line Merge	On, Off
Color Mode (HP-GL/2)	EPSON Standard (sRGB), Business Graphics, GIS, Line Drawing, Off (No Color Management)
Select Palette	Software, Default, Palette A, Palette B
Print Color Palette	Print
<b>Define Palette</b>	
Palette A	Display screen to set pen width and pen color
Palette B	
Restore default HP-GL/2 Unique Settings	Yes, No



### Using the Menu

Settings item	Settings value
Thick Paper	Off, Accept
Bidirectional	Accept, Off
PC Connection via USB	Enable, Disable
USB I/F Timeout Setting	0.5 to 300 sec
Network Settings (Details of each item <a href="#">↗</a> "General Settings - Network Settings" on page 127)	
Wi-Fi Setup	
Router	
Connect via Wi-Fi	When wireless LAN connection disabled: Display <b>Connect via Wi-Fi</b> menu When wireless LAN connection connected: Display connection status and settings information
Wi-Fi Setup Wizard	
Push Button Setup(WPS)	
Others	
PIN Code Setup(WPS)	
Wi-Fi Auto Connect	
Disable Wi-Fi	
Wi-Fi Direct	
Wi-Fi Direct	When Wi-Fi Direct disabled: Display <b>Wi-Fi Direct</b> wizard When Wi-Fi Direct enabled: Display settings information and number of connected devices
Change Password	
Disable Wi-Fi Direct	
Delete Registered Device	
Wired LAN Setup	Start Setup (Displayed when connected to a wireless LAN.)
Network Status	
Wired LAN/Wi-Fi Status	Display current connection settings
Wi-Fi Direct Status	
Print Status Sheet	Print

### Using the Menu

Settings item	Settings value
Connection Check	Start network connection check
Advanced	
Device Name	Display settings change screen
TCP/IP	
Proxy Server	
IPv6 Address	Enable, Disable
Link Speed & Duplex	Auto, 10BASE-T Half Duplex, 10BASE-T Full Duplex, 100BASE-TX Half Duplex, 100BASE-TX Full Duplex
Redirect HTTP to HTTPS	Enable, Disable
Disable IPsec/IP Filtering	Proceed
Disable IEEE802.1X	(Displayed when enabled.)
System Administration (Details of each item <a href="#">↗</a> "General Settings - System Administration" on page 130)	
Security Settings	
Admin Settings	
Admin Password	Register, Change, Clear All Settings
Lock Setting	Off, On
Restore Default Settings	
all Wi-Fi/network settings	Yes, No
Clear All Data and Settings	Yes, No
Firmware Update	
Update	Start Checking
Notification	Off, On
Supply Status	Display approximate remaining amounts, as well as product number of consumables
Maintenance (Details of each item <a href="#">↗</a> "Maintenance" on page 131)	

### Using the Menu

Settings item	Settings value
Print Quality Adjustment	Start
Print Head Nozzle Check	Start
Head Cleaning	Start
Paper Guide Cleaning	Start
Ink Cartridge(s) Replacement	Start
Replace Maintenance Box	Display procedure
Replace Cutter	Start
Powerful Cleaning	Start
Discharging/Charging Ink	Start
Language	Display supported languages
Printer Status/Print (Details of each item <a href="#">↗</a> "Printer Status/Print" on page 132)	
Print Status Sheet	
Configuration Status Sheet	Print
Network	Display <b>General Settings - Network Settings - Network Status</b>

## Using the Menu

### Enlarged Copy

Displayed when an Epson A3 or A4 scanner is connected to the printer. Set scaling in this menu to enable enlarged printing of the scanned documents.

Details of each item  [“Enlarged Copy menu” on page 133](#)

Settings item	Settings value
Copies	1 to 99
Color Mode	Black/White, Color
Original Size	A4, A5, A3, B5, B4, Letter, 13 x 18 cm (5 x 7 in), User-Defined
Reduce/Enlarge	
Auto Fit Page	On, Off
Custom Size	A0*, US E (34x44in)*, JIS B1*, A1, US D (22x34in), JIS B2, US C (17x22in), A2, User-Defined *Only SC-T5100 Series/SC-T5100N Series is displayed.
Density	-4 to 4
Quality	Speed, Fine



## Using the Menu

## Paper Setting menu



### Roll Paper menu

- ❑ The Paper Setting menu is displayed if paper is loaded.
- ❑ **Media Adjust** adjustment results, and settings in **Advanced Media Setting** and **Manage Remaining Amount** are stored for each paper type in **Paper Type**. Changing adjustments and settings will save these as the currently selected paper type settings even if the power is turned off.

\*Default setting

Settings item	Settings value	Explanation
Remove		Rewind the roll paper until it is ejected from inside the printer.  <a href="#">"Removing Roll Paper" on page 32</a>
Feed/Cut Paper	Backward	Use Backward and Forward to move the paper to the desired position. Touch Cut to cut the paper using the built-in cutter.  <a href="#">"Cutting the Roll Paper" on page 30</a>
	Forward	
	Cut	
Media Adjust	Start	Run this adjustment when there is a problem with print results, or after registering custom paper settings. Touch <b>Start</b> to print an adjustment pattern. Then, follow the on-screen instructions to make adjustments. Adjustment results will be saved as the currently selected paper type settings.  <a href="#">"Optimizing Paper Settings (Media Adjust)" on page 43</a>
Advanced Media Setting		

### Using the Menu

Settings item	Settings value	Explanation
Platen Gap	1.6	Displayed when in <b>Paper Type, Custom Paper</b> is selected. When registering Custom Paper, this is the Platen Gap (distance between print head and paper) for the paper selected in <b>Change Reference Paper</b> , therefore this does not normally need to be changed. Change to a wider setting (a higher value) if print results are smeared.
	2.1	
	2.6	
Top/Bottom Margins	Standard*	Setting this to Standard will set the top/bottom margins as follows depending on the printer driver print targets. <ul style="list-style-type: none"> <li><input type="checkbox"/> CAD/Line Drawing: 3 mm/3 mm</li> <li><input type="checkbox"/> Other: 30 mm/30 mm</li> </ul> Left and right margins will remain at 3 mm regardless of settings. If there is any soiling to the top section of the print results, then try increasing the top margin before printing.  <a href="#">"Printable area" on page 163</a>
	Top 3 mm/Bottom 3 mm	
	Top 15 mm/Bottom 15 mm	
Back Tension	Auto	If there is any wrinkling on the paper during printing, set this to <b>High</b> or <b>Extra High</b> .
	Standard	
	High	
	Extra High	
Drying Time		
Drying Time per Pass	0.0 to 10.0 seconds (0.0*)	Select the time the print head pauses to allow drying after each pass. Choose from values between 0.0 and 10.0 seconds. Depending on the paper type, the ink may take a while to dry. If the ink blurs on the paper, set a longer time for drying the ink. Increasing the drying time increases the time needed to print.
Drying Time per Page	0.0 to 60 minutes (0.0*)	Specify how long the printer pauses to allow the ink to dry after printing each page; choose from values between 0.0 and 60 minutes. Depending on the ink density or paper type, the ink may take a while to dry. If the ink blurs on the paper, set a longer time for drying the ink. The longer the drying time, the more time required for printing.
Auto Cut	On*	Choose On to automatically cut roll paper using the built-in cutter as each page is printed or Off to disable auto paper cutting. Setting this to On automatically cuts the edge when the edge is not a horizontal cut when setting paper. The setting selected with the printer driver takes priority when the printer driver is used.  <a href="#">"Cutting the Roll Paper" on page 30</a>
	Off	
Manage Remaining Amount		

### Using the Menu

Settings item	Settings value	Explanation
Setup	On	Select whether to display/record (On) or not to display/record (Off) the amount of remaining roll paper. Setting this to <b>On</b> , enables <b>Remaining Amount</b> and <b>Remaining Alert</b> . ↗ "For Roll Paper" on page 39
	Off*	
Remaining Amount	5.0 to 150.0 m (30*)	Inputting the roll paper total length set in <b>Remaining Amount</b> displays the approximate remaining amount of roll paper on the printer's Home screen and on the printer driver screen.
Remaining Alert	1.0 to 15.0 m (5.0*)	In <b>Remaining Alert</b> , set the limit at which to display a warning when the amount of remaining roll paper drops below that limit. You can set in 0.1 m increments.
Change Paper Type		
Paper Type	Plain paper*	Select the type of paper loaded. The three options other than <b>Others</b> display the most recently selected paper type. When the desired paper type is not displayed, touch <b>Others</b> to display these, and select. ↗ "For Roll Paper" on page 39
	Coated Paper(Generic)	
	Premium Glossy Sheet	
	Others	

## Using the Menu

### Auto Sheet Feeder menu

The Paper Setting menu is displayed if paper is loaded.

\*Default setting

Settings item	Settings value	Explanation
Media Adjust	Start	<p>Run this adjustment when there is a problem with print results, or after registering custom paper settings.</p> <p>Touch <b>Start</b> to print an adjustment pattern. Then, follow the on-screen instructions to make adjustments.</p> <p>Adjustment results will be saved as the currently selected paper type settings.</p> <p><a href="#">🔗 "Optimizing Paper Settings (Media Adjust)" on page 43</a></p>
Change Paper Type/Paper Size		
Paper Type	Plain paper*	<p>Select the type of paper loaded. The three options other than <b>Others</b> display the most recently selected paper type. When the desired paper type is not displayed, touch <b>Others</b> to display these, and select.</p> <p><a href="#">🔗 "For Auto Sheet Feeder / Cut Sheet(1 sheet)" on page 41</a></p>
	Coated Paper(Generic)	
	Premium Glossy Sheet	
	Others	
Paper Size	A4	<p>Select the size of paper loaded.</p> <p>If the desired size is not in the options, then select <b>User-Defined</b>, and enter the paper width and length.</p>
	A3	
	JIS B4	
	ISO B4	
	Letter (8 1/2x11in)	
	Legal (8 1/2x14in)	
	US B (11x17in)	
	ARCH A (9x12in)	
	User-Defined	



## Using the Menu

### Cut Sheet(1 sheet) menu

The Paper Setting menu is displayed if paper is loaded.



\*Default setting

Settings item	Settings value	Explanation
Remove		Touch to eject set cut sheet (1 sheet) without printing. Touch to eject to the front. <a href="#">☞ "Removing Cut Sheet (1 Sheet)" on page 38</a>
Media Adjust	Start	Run this adjustment when there is a problem with print results, or after registering custom paper settings. Touch <b>Start</b> to print an adjustment pattern. Then, follow the on-screen instructions to make adjustments. Adjustment results will be saved as the currently selected paper type settings. <a href="#">☞ "Optimizing Paper Settings (Media Adjust)" on page 43</a>
Change Paper Type/Paper Size		
Paper Type	Plain paper*	Select the type of paper loaded. The three options other than <b>Others</b> display the most recently selected paper type. When the desired paper type is not displayed, touch <b>Others</b> to display these, and select. <a href="#">☞ "For Auto Sheet Feeder / Cut Sheet(1 sheet)" on page 41</a>
	Coated Paper(Generic)	
	Premium Glossy Sheet	
	Others	
Paper Size	A Series	Select the size of paper loaded. If the desired size is not in the options, then select <b>User-Defined</b> , and enter the paper width and length.
	US-ANSI	
	US-ARCH	
	B Series (ISO)	
	B Series (JIS)	
	Others	
	User-Defined	

Using the Menu

# Printer Status menu

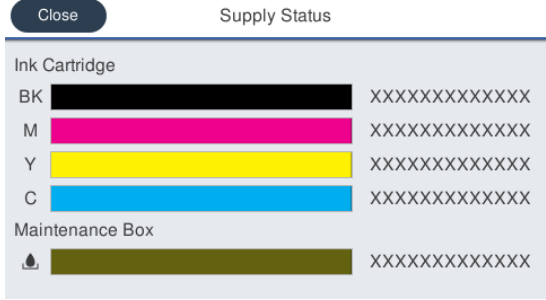
\*Default setting

Settings item	Settings value	Explanation
Supply Status		<p>Display the approximate remaining amounts of each color in ink cartridge and its product number, and the approximate capacity in and product number of the Maintenance Box.</p>  <p>The shorter a bar is, the lower the remaining amount or amount of ink or space. Even if  is displayed, printing is possible until replacement is instructed. However, ensure that a new ink cartridge of that color, or a new Maintenance Box is readied in advance.</p> <p>Furthermore, the ink color codes beside the bars indicate the following.</p> <ul style="list-style-type: none"> <li><input type="checkbox"/> K: Black</li> <li><input type="checkbox"/> M: Magenta</li> <li><input type="checkbox"/> Y: Yellow</li> <li><input type="checkbox"/> C: Cyan</li> </ul>
Message List		Display a list of messages communicating printer status. Select a message from the list to display detailed information.
Firmware Version		Display the printer firmware version.
Print Status Sheet		
	Configuration Status Sheet	Print a list of current printer settings. Use this to view all information at a glance.

Using the Menu

# Settings menu

## General Settings

### General Settings - Basic Settings

\*Default setting

Settings item	Settings value	Explanation
LCD Brightness	1 to 9 (9*)	Adjust screen brightness.
Sound		
Mute	On	Setting this to <b>On</b> will mute sound when touching the menu or other items on the control panel screen, and the confirmation sound when inserting paper into the paper slot when loading paper.
	Off*	
Normal Mode		
Button Press	0 to 10 (5*)	Adjust the volume of the sound when touching the menu or other items on the control panel screen, and of the confirmation sound when inserting paper into the paper slot when loading paper.
Error Notice	0 to 10 (5*)	Adjust the volume of the sound notifying of an error.
Sound Type	Pattern1*	Adjust the type of the sound when touching the menu or other items on the control panel screen, and of the confirmation sound when inserting paper into the paper slot when loading paper.
	Pattern2	
Sleep Timer	1 to 210 minutes (15*)	The printer will enter sleep mode if no errors have occurred, no print jobs have been received, and no actions are performed on the control panel for an extended period of time. This setting selects the amount of time until the printer enters sleep mode. <a href="#">🔗 "Saving Power" on page 21</a>
Power Off Timer	Off	You can select the time after which the printer will turn off automatically if no errors have occurred, no print jobs have been received, or no actions are performed on the control panel for an extended period of time. <a href="#">🔗 "Saving Power" on page 21</a>
	30minutes	
	1h	
	2h	
	4h	
	8h*	
	12h	
Circuit Breaker Interlock Startup	On*	Select whether to turn the printer on (On) or off (Off) when the breaker switch is turned on.
	Off	
Date/Time Settings		

## Using the Menu

Settings item	Settings value	Explanation
Date/Time	-	Enter the current date and time.
Time Difference	-12:45 to +13:45 (0.00*)	Set the difference with coordinated universal time (UTC) in 15 minute increments.  In network environments with a time difference, set this as necessary when administrating the printer.
Language	Japanese	Select the language used on the control panel's screen.
	English	
	French	
	Italian	
	German	
	Portuguese	
	Spanish	
	Dutch	
	Polish	
	Russian	
	Korean	
	Simplified Chinese	
Traditional Chinese		
Operation Time Out	On*	Setting this to <b>On</b> will, if no operations are made for a fixed amount of time on a screen display other than on the Home screen, display a message, and return to the Home screen.
	Off	
Keyboard	QWERTY*	Select the key arrangement for the text input screen displayed when entering the Custom Paper registered name or similar.
	AZERTY	
	QWERTZ	
Length Unit	m*	Select the units of length to use when displaying the length of roll paper and other items.
	ft / in	

Using the Menu

General Settings - Printer Settings

\*Default setting

Settings item	Settings value	Explanation
Paper Source Settings		
Error Notice		
Paper Size Notice	On	Setting this to <b>On</b> will display an error message when the output size or paper type settings of print jobs sent to the printer differ from those settings in the printer.
	Off*	
Paper Type Notice	On	
	Off*	
Roll Paper Setup		
Detect Paper Meandering	On*	If On is selected, an error will be displayed in the control panel and printing will stop if the paper is skewed; select Off to disable this feature. On is recommended in most circumstances as skewed paper may cause the printer to jam.
	Off	
Print Cutting Guideline	On	If Auto Cut is Off, you can choose to print (On) or not print (Off) cut lines on roll paper. Cut lines are not printed if Auto Cut is On or when cut sheets are used. Note, however, that if the roll width selected with the computer is narrower than the paper loaded in the printer, cut lines will be printed regardless of the option selected for Auto Cut. The setting selected with the printer driver takes priority when the printer driver is used.
	Off*	
After-Print Options	Hold Paper*	After printing, select whether to retain in the paper eject slot (Hold Paper) or fully eject (Eject Paper) the bottom of cut sheets or automatically cut roll paper. This function prevents printed paper being ejected and falling to the floor, whereupon the printed surface may be marked, therefore we recommend this be set to <b>Hold Paper</b> . If <b>Hold Paper</b> is set, manually grasp the edge of the paper and remove it from the printer in order to prevent it falling to the floor.
	Eject Paper	

### Using the Menu

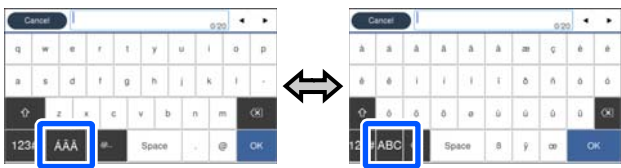
Settings item	Settings value	Explanation
<b>Custom Paper Setting</b> (Touching any of registry number 01 to 10 will display settings items.)		
Change Name		Register and change the name of the custom paper settings. The name registered here is displayed in the <b>Paper Type</b> list. Touch this to display the keyboard screen. Up to 20 characters may be input for the name. The keypad screen can be switched as shown below with the button marked.    Touch the icons at bottom left to switch between input methods. ABC: Enters alphabet letters 123#: Enters numbers and symbols To change the key layout of the full keyboard, use <b>Keyboard</b> in the Basic Settings menu. <a href="#">👉 "General Settings - Basic Settings" on page 115</a>
Change Reference Paper	Plain paper*	You can select the media type that is the closest to the paper you are using.
	Matte Paper	
	Photo Paper	
	CAD	
	Others	
<b>Advanced Media Setting</b>		
Platen Gap	1.6	This is the Platen Gap (distance between print head and paper) for the paper selected in <b>Change Reference Paper</b> , therefore this does not normally need to be changed. Change to a wider setting (a higher value) if print results are smeared.
	2.1	
	2.6	

### Using the Menu

Settings item	Settings value	Explanation
Top/Bottom Margins	Standard*	Setting this to Standard will set the top/bottom margins as follows depending on the printer driver print targets. <input type="checkbox"/> CAD/Line Drawing: 3 mm/3 mm <input type="checkbox"/> Other: 30 mm/30 mm Left and right margins will remain at 3 mm regardless of settings. If there is any soiling to the top section of the print results, then try increasing the top margin before printing. <a href="#">📄 "Printable area" on page 163</a>
	Top 3 mm/Bottom 3 mm	
	Top 15 mm/Bottom 15 mm	
	Top 45 mm/Bottom 15 mm	
Back Tension	Auto*	If there is any wrinkling on the paper during printing, select <b>High</b> or <b>Extra High</b> .
	Standard	
	High	
	Extra High	
Drying Time		
Drying Time per Pass	0.0 to 10.0 seconds (0.0*)	Select the time the print head pauses to allow drying after each pass. Choose from values between 0.0 and 10.0 seconds. Depending on the paper type, the ink may take a while to dry. If the ink blurs on the paper, set a longer time for drying the ink. Increasing the drying time increases the time needed to print.
Drying Time per Page	0.0 to 60 minutes (0.0*)	Specify how long the printer pauses to allow the ink to dry after printing each page; choose from values between 0 and 60 minutes. Depending on the ink density or paper type, the ink may take a while to dry. If the ink blurs on the paper, set a longer time for drying the ink. The longer the drying time, the more time required for printing.
Auto Cut	On*	Choose On to automatically cut roll paper using the built-in cutter as each page is printed or Off to disable auto paper cutting. Setting this to On also automatically cuts the leading edge if the edge is not a horizontal cut when the roll paper is loaded.  The setting selected with the printer driver takes priority when the printer driver is used.  <a href="#">📄 "Cutting the Roll Paper" on page 30</a>
	Off	
Restore Default		Restore the selected Custom Paper settings to default settings.
Printing Language		
USB	Auto*	Normally, leave the setting as Auto. If HP-GL/2 or HP RTL print data is sent from a CAD application or plotter, this is automatically determined, and switched to HP-GL/2 mode. If HP-GL/2 mode printing is not carried out normally, or if normally printing in HP-GL/2 or HP RTL, set as <b>HP-GL/2</b> .
	HP-GL/2	
Network	Auto*	
	HP-GL/2	

### Using the Menu

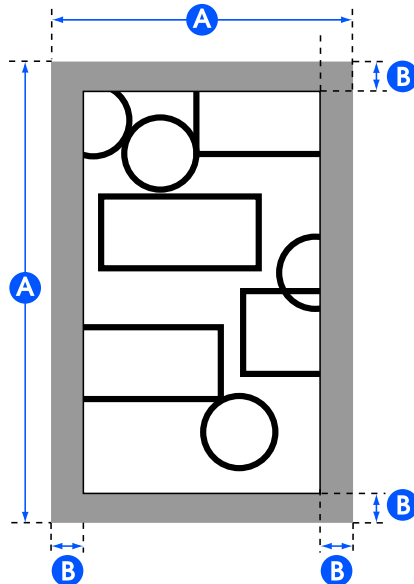
Settings item	Settings value	Explanation
Universal Print Settings (Print setting for when printing in HP-GL/2 or HP RTL mode, or when printing with AirPrint.)		
Paper Source	Roll Paper*	Select the paper source. If the paper is not loaded as in the set paper source, then an error will occur during printing.
	Auto Sheet Feeder	
	Cut Sheet(1 sheet)	
Quality	Standard*	Select the print quality. <b>Standard</b> will print with the quality mode appropriate for that paper's Paper Type settings selected in <b>Paper Source</b> .
	Speed	
	Fine	
	Super Fine	
Color Mode	Color*	Specify whether to print in color or switch to black and white and then print.
	Black/White	
Page Margins option	Clip By Margins*	<p>Depending on the base output size setting, adds the value selected for the page margin (area of <b>B</b> in the following illustration) inside the hard clip area of the PS command of the data or the size selected for base output size (area of <b>A</b> in the following illustration). When there is a print object in the margin section, it is clipped and not printed.</p> 

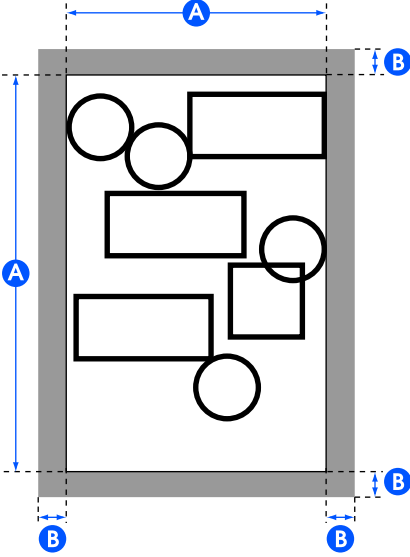
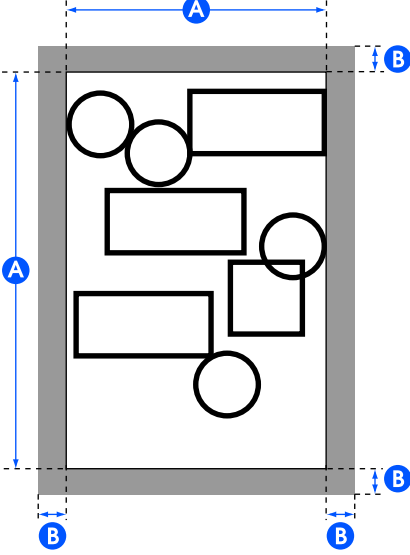

### Using the Menu

Settings item	Settings value	Explanation
	Oversize	<p>The position at which the margin is added depends on the base output size setting, as shown below.</p> <ul style="list-style-type: none"> <li> <input type="checkbox"/> When set to Auto                      Adds the value selected for page margin (area of <b>B</b> in the following illustration) outside the hard clip area of the PS command of the data (area of <b>A</b> in the following illustration).                 </li> </ul>  <ul style="list-style-type: none"> <li> <input type="checkbox"/> When set to a standard size or user defined size                      Adds the value selected for page margin (area of <b>B</b> in the following illustration) outside the size selected for base output size (area of <b>A</b> in the following illustration). With the actual output size, the margin section becomes larger than the selected size (the area of <b>A</b> in the following illustration).                 </li> </ul> 

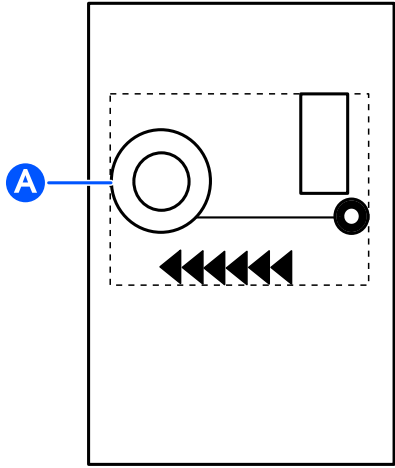

### Using the Menu

Settings item	Settings value	Explanation
Page Margin	3 mm*	Select the top, bottom, left, and right margin values.
	5 mm	For a cut sheet, the top, bottom, left, and right margin values are 3 mm regardless of the settings.
Smoothing	On	This setting is enabled when <b>Resolution</b> is set to <b>Standard</b> , and resolution not specified in the sent print data. Setting this to <b>On</b> prints at the maximum resolution corresponding to that paper's Paper Type settings selected in <b>Paper Source</b> , but depending on the data, this may result in a long print time, or failures in printing because of insufficient memory.
	Off*	
Base Output Size	Auto*	<p>The hard clip area of the PS command of the data becomes the base output size. The actual output size depends on the Page Margins option. When the data does not contain a PS command, the smallest rectangle area <b>A</b> of in the following illustration including the print object becomes the base output size.</p> 
	A Series	<p>The compatible standard sizes for the selected <b>Paper Source</b> are displayed, therefore select the Base Output Size. The actual output size depends on the Page Margins option.</p> <p>For a cut sheet, this setting is available only when the data does not contain a PS command. If the data contains a PS command, this setting is not available, and the hard clip area of the PS command becomes the Base Output Size.</p>
	US-ANSI	
	US-ARCH	
	B Series (ISO)	
	B Series (JIS)	
	Others	
User-Defined	<p>Select this option when outputting at non-standard sizes. After selecting this setting, set Paper Width and Paper Height. You can set in 0.1 mm increments.</p> <p>The actual output size depends on the Page Margins option.</p>	

### Using the Menu

Settings item	Settings value	Explanation
Resolution	Standard*	This setting is enabled when resolution not specified in the sent print data. When <b>Standard</b> is selected, this will print in accordance with that paper's Paper Type settings selected in <b>Paper Source</b> , and at the resolution in the <b>Quality</b> settings.
	300dpi	
	600dpi	
	1200dpi	
Color Mode (Common)	EPSON Standard (sRGB)	Optimize the sRGB space and correct the color.
	Business Graphics*	Perform color correction to sharpen your images based on the sRGB space.
	GIS	Perform color correction suitable for when printing GIS (Geographic Information System) topographical maps or similar.
	Line Drawing	Perform color correction suitable for CAD drawings and other line drawings.
	Off (No Color Management)	Do not perform color correction.
<b>HP-GL/2 Unique Settings</b> (Print settings inherent to HP-GL/2 or HP RTL modes.)		
Rotate	0°	You can rotate the coordinates of the drawn data counterclockwise in units of 90° before printing. Note that objects drawn by RTL are not rotated. When both this setting and the RO command specify rotation, rotation is performed using the combined amount of both values. Note that rotation by the RO command is for objects only (the arrow section in the following illustration), and rotation is not performed for the drawn area (the square section in the following illustration). As a result, objects in a section that protrude from the drawn area are not printed.
	90°	
	180°	
	270°	
Origin Setup	Left Edge*	Set the data coordinate origin.
	Center	

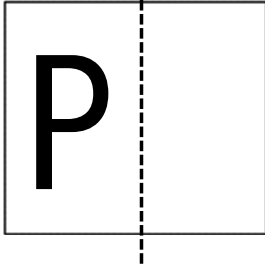
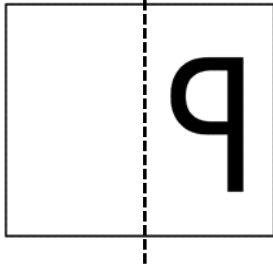
### Using the Menu

Settings item	Settings value	Explanation
Mirror Image	On	<p>Select whether to flip horizontally (mirror) using the center of the output size width as the basis line and then print (On) or print without flipping horizontally (Off).</p> <div style="display: flex; justify-content: space-around; align-items: center;"> <div style="text-align: center;"> <p>OFF</p>  </div> <div style="text-align: center;"> <p>ON</p>  </div> </div> <p>If an angle is specified for rotate, the rotated result is flipped horizontally.</p>
	Off*	
Line Merge	On	<p>Select whether to merge the intersection of the overlapping lines within the image according to the MC command of the data (On), or move lines to be printed later to the front at intersections (Off).</p> <div style="display: flex; justify-content: space-around; align-items: center;"> <div style="text-align: center;"> <p>ON</p>  </div> <div style="text-align: center;"> <p>OFF</p>  </div> </div>
	Off*	
Color Mode (HP-GL/2)	EPSON Standard (sRGB)	Optimize the sRGB space and correct the color.
	Business Graphics	Perform color correction to sharpen your images based on the sRGB space.
	GIS	Perform color correction suitable for when printing GIS (Geographic Information System) topographical maps or similar.
	Line Drawing*	Perform color correction suitable for CAD drawings and other line drawings.
	Off (No Color Management)	Do not perform color correction.

### Using the Menu

Settings item	Settings value	Explanation
Select Palette	Software*	<p>From the following selections, choose the palette that specifies the color and thickness of the logical pen.</p> <ul style="list-style-type: none"> <li><input type="checkbox"/> Software: Print according to the pen configurations set in the application, and ignore the built-in palette of the printer.</li> <li><input type="checkbox"/> Default: Print according to the settings of the built-in palette of the printer specified in advance. The settings of the palette cannot be changed. The built-in palette specifies a logical pen with a pen width of 0.35 mm and 256 colors.</li> <li><input type="checkbox"/> Palette A / Palette B: Print according to the settings of the built-in palette that you specified for Define Palette. If Define Palette setting is not set, the results are the same as when Default is selected.</li> </ul> <p>When Default / Palette A / Palette B are set, pen configurations set in the application are ignored.</p> <p>Selected palette settings can be printed with <b>Print Color Palette</b> and confirmed.</p>
	Default	
	Palette A	
	Palette B	
Print Color Palette	Print	Settings of the palette selected in <b>Select Palette</b> are printed as A3 size. You can check the colors corresponding to the color number for the pen colors.
Define Palette		
Palette A		
Pen 0 to Pen 15		
Pen Width	0.13 to 12.00 mm	<p>In <b>Select Palette</b>, selecting <b>Palette A</b> will print in accordance with settings defined here.</p> <p>You can define a unique built-in palette by specifying the pen width and color for the 16 types of logical pen. Select the pen number, and then define the pen width and pen color for each pen.</p> <p>You can use <b>Print Color Palette</b> to print and check the colors corresponding to the color number for the pen colors.</p>
Pen Color	0 to 255	
Palette B		
Pen 0 to Pen 15		
Pen Width	0.13 to 12.00 mm	<p>In <b>Select Palette</b>, selecting <b>Palette B</b> will print in accordance with settings defined here.</p> <p>Settings details are the same as for Palette A.</p>
Pen Color	0 to 255	
Restore default HP-GL/2 Unique Settings	No	<p>Select <b>Yes</b> to restore all HP-GL/2 Unique Settings settings to default settings.</p>
	Yes	
Thick Paper	Off*	<p>If the paper is thick, the print head may scuff the print surface. Choose <b>On</b> to prevent scuffing. If <b>On</b> is set, the platen gap, which is the distance between the print head and the paper, will widen. However, if the platen gap is already at its maximum, then setting this to <b>On</b> will have no effect.</p>
	On	
Bidirectional	On*	<p>Setting this to <b>On</b> means the print head prints while moving left and right. Setting this to <b>Off</b> means that ruled lines will have less misalignment, but printing will take more time.</p>
	Off	

**Using the Menu**

<b>Settings item</b>	<b>Settings value</b>	<b>Explanation</b>
PC Connection via USB	Enable*	Setting this to <b>Enable</b> allows access from a USB-connected computer. Setting this to <b>Disable</b> does not allow access.
	Disable	
USB I/F Timeout Setting	0.5 to 300 seconds (60*)	If printing stops mid-way when the printer and computer are connected by a USB cable, set a longer time.



## Using the Menu

### General Settings - Network Settings

\*Default setting

Settings item	Settings value	Explanation
Wi-Fi Setup		
Router (Connect via Wi-Fi)		<p><b>Disconnected or disabled</b></p> <p>This is displayed in gray. Touch this, and on the next screen touching <b>Start Setup</b> will display a <b>Wi-Fi Setup Wizard</b> menu, performing a connection operation.</p> <p><b>Connected</b></p> <p>Touch to display the connection status and settings information. Touch <b>Change Settings</b> to display a <b>Wi-Fi Setup Wizard</b> menu, where you can switch access points.</p> <p> <a href="#">"Switching to Wireless LAN" on page 93</a></p>
Wi-Fi Setup Wizard		The list of SSIDs for the detected access points is displayed. From the list, select the SSID to connect to, and connect.
Push Button Setup(WPS)		If the access point to use supports WPS (Wi-Fi Protected Setup), then this menu item can be used for connection. Input of SSID and password is not required. After selecting this menu item, touch and hold the push button on the access point until it flashes, then again touch <b>Start Setup</b> on the printer screen to connect.
Others		
PIN Code Setup(WPS)		If the access point to use supports WPS (Wi-Fi Protected Setup), then this menu item can be used for connection. Touch this to display the PIN code and <b>Start Setup</b> . Input the displayed PIN code from a computer into the access point within 2 minutes, then touch <b>Start Setup</b> to connect.
Wi-Fi Auto Connect		The menu used after installing software from the Software Disc, and connecting to the printer by following the wizard.
Disable Wi-Fi		Selecting this means that the wireless LAN connection will be initialized and disconnected. In the event of problems with the wireless LAN connection, use this menu to reconnect and attempt to resolve the problem.

## Using the Menu

Settings item	Settings value	Explanation
Wi-Fi Direct (Wi-Fi Direct)		<p><b>Disconnected or disabled</b></p> <p>This is displayed in gray. Touch this, and on the next screen touching <b>Start Setup</b> will display <b>Start Setup</b>. Touch <b>Start Setup</b> to enable Wi-Fi Direct, and this will display the printer SSID and password.</p> <p><b>Connected</b></p> <p>Touch to display the printer SSID and password, as well as the number of connected devices. Touch <b>Change Settings</b> to display a <b>Change Password</b> menu.</p> <p> <a href="#">"Directly Connection Wirelessly (Wi-Fi Direct)" on page 94</a></p>
	Change Password	You can change the Wi-Fi Direct password. Changing the password will disconnect all connected computers and smart devices.
	Disable Wi-Fi Direct	Performing this operation will disconnect all connected computers and smart devices. To disconnect only specific devices, disconnect the connection between that device and the printer.
	Delete Registered Device	<p>Android smart device menu item.</p> <p>When using the Wi-Fi Direct function on an Android smart device to connect to the printer, a screen upon which to select whether to approve or refuse this connection will be displayed on the printer. If refuse is selected, then subsequent connection with this device will not be possible. To connect with devices for which connection has been refused, open this menu, and delete registered device information.</p>
Wired LAN Setup		<p>Touch to change a wireless LAN connection to an wired LAN connection. Touch <b>Start Setup</b> to disable wireless LAN connection.</p> <p> <a href="#">"Switching to Wired LAN" on page 93</a></p>
Network Status		
	Wired LAN/Wi-Fi Status	Display current communications status and connection settings such as IP address, etc.
	Wi-Fi Direct Status	Display number of connected devices and connection settings such as SSID.
	Print Status Sheet	Print current network connection detailed information.
Connection Check		Confirm the network status of the printer, and print a network connection check report. In the event of problems, respond in accordance with the diagnostics results.
Advanced		



### Using the Menu

Settings item	Settings value	Explanation
Device Name		Set the name of the printer to use on the network.
TCP/IP	Auto*	Automatically assign the printer IP address using DHCP functionality in the router.
	Manual	Select this to manually assign a fixed IP address, then input the IP address, subnet mask, and other required information. For details, see the <i>Administrator's Guide</i> .
Proxy Server	Use	When using a proxy server to directly connect from the intranet to the Internet so that the printer may directly access the Internet for firmware updates or similar, select <b>Use</b> , and set the server name and port number.
	Do Not Use*	
IPv6 Address	Enable*	Select whether to enable or disable the IPv6 function.
	Disable	
Link Speed & Duplex	Auto*	Normally, set this to <b>Auto</b> .
	10BASE-T Half Duplex	
	10BASE-T Full Duplex	
	100BASE-TX Half Duplex	
	100BASE-TX Full Duplex	
Redirect HTTP to HTTPS	Enable*	Select whether to enable or disable the function to auto-redirect HTTP to HTTPS.
	Disable	
Disable IPsec/IP Filtering	Enable	To enable IPsec/IP filtering functionality, use Web Config. For details, see the <i>Administrator's Guide</i> .
	Disable*	
Disable IEEE802.1X	Enable	To enable IEEE802.1X functionality, use Web Config. For details, see the <i>Administrator's Guide</i> .
	Disable*	

## Using the Menu

### General Settings - System Administration

\*Default setting

Settings item	Settings value	Explanation
Security Settings		
Admin Settings		
Admin Password	Register	<p>When using the Lock Setting function, touch <b>Register</b> and set the administrator password. If changing a password that has already been set, touch <b>Change</b> and set the new password.</p> <p>Set the password and set <b>Lock Setting</b> to <b>On</b> to ask for input of a password when displaying specific settings menus such as network configuration.</p> <p>These menus will only be displayed if the correct password is entered, preventing non-administrators from accidentally changing settings.</p> <p>Keep the password in a safe place.</p> <p>Should you forget the password, contact your dealer or Epson Support.</p>
	Change	
	Clear All Settings	
Lock Setting	Off*	<p>Setting this to <b>On</b> means that input of the administrator password will be requested when selecting the following menu items, and unless the password is entered, changing of configurations or running functions will not be possible. When selecting On, first set the Admin Password.</p> <ul style="list-style-type: none"> <li><input type="checkbox"/> Sleep Timer</li> <li><input type="checkbox"/> Power Off Timer</li> <li><input type="checkbox"/> Circuit Breaker Interlock Startup</li> <li><input type="checkbox"/> Date/Time Settings</li> <li><input type="checkbox"/> Operation Time Out</li> <li><input type="checkbox"/> Printing Language</li> <li><input type="checkbox"/> Universal Print Settings</li> <li><input type="checkbox"/> PC Connection via USB</li> <li><input type="checkbox"/> USB I/F Timeout Setting</li> <li><input type="checkbox"/> Network Settings</li> <li><input type="checkbox"/> Powerful Cleaning</li> <li><input type="checkbox"/> Discharging/Charging Ink</li> </ul>
	On	
Restore Default Settings		
all Wi-Fi/network settings	Yes	Touch <b>Yes</b> to restore all network settings to default settings.
	No	
Clear All Data and Settings	Yes	Touch <b>Yes</b> to restore all settings with the exception of Date/Time Settings, Length Unit, and Language in the Settings menu to default settings.
	No	
Firmware Update		

## Using the Menu

Settings item	Settings value	Explanation
Update		Using this function requires that the printer be connected to a network that can be connected to the Internet. Touch <b>Start Checking</b> to access the Epson website, and to start a search for new firmware. If there is a display indicating that there is new firmware, then follow the on-screen instructions to update the firmware. Updating firmware takes approximately 5 minutes. However, this may take longer depending on the network environment. During update, do not turn off the printer or unplug the power cable from the outlet. Failure to observe this precaution could lead to damage.
Notification	Off*	Setting this to <b>On</b> means the printer will automatically check periodically for new firmware. If new firmware is found, a message will be displayed when the power is turned on.
	On	

## Maintenance

Settings item	Settings value	Explanation
Print Quality Adjustment	Start	Perform the same adjustment as in <b>Media Adjust</b> in the Paper Setting menu. When carrying out this action from this menu, select the paper source from the first screen. <a href="#">☞ "Optimizing Paper Settings (Media Adjust)" on page 43</a>
Print Head Nozzle Check	Start	Check for clogged nozzles by printing a check pattern. <a href="#">☞ "Checking for Clogged Print Head, and Cleaning" on page 134</a>
Head Cleaning	Start	Perform if the printed check pattern has faint or missing areas. <a href="#">☞ "Checking for Clogged Print Head, and Cleaning" on page 134</a>
Paper Guide Cleaning	Start	Perform if there is soiling on the printed surface when printing from the auto sheet feeder. <a href="#">☞ "Smearing occurs on printed matter from the auto sheet feeder." on page 148</a>
Ink Cartridge(s) Replacement	Start	Touch <b>Start</b> to move the print head to the position at which the ink cartridge can be replaced. The replacement procedure is shown on the screen, so replace the ink cartridges while referring to this. <a href="#">☞ "Replacing Ink Cartridges" on page 135</a>
Replace Maintenance Box	Start	Select when replacing the Maintenance Box while confirming the procedure. If you are familiar with replacement and do not need to confirm the procedure, you can replace the Maintenance Box without selecting this menu item. <a href="#">☞ "Maintenance Box Replacement" on page 137</a>
Replace Cutter	Start	Select to replace the cutter if the paper is not cut cleanly. Follow the on-screen instructions to replace. <a href="#">☞ "Replacing the Cutter" on page 138</a>
Powerful Cleaning	Start	Perform if the check pattern has faint or missing areas even after carrying out <b>Head Cleaning</b> three times in a row. <a href="#">☞ "Powerful Cleaning" on page 134</a>

### Using the Menu

Settings item	Settings value	Explanation
Discharging/Charging Ink	Start	<p>The print head may fail if the environmental temperature becomes -10°C or lower. Perform this action if you expect to be transporting/storing the printer in an environment of -10°C or less.</p> <p>Touch <b>Start</b>, and follow the on-screen instructions to eject the ink. When operations are complete, the power turns off automatically.</p> <p> <a href="#">"Handling if Transporting/Leaving the Printer in an Environment of -10°C or Less" on page 167</a></p>

## Printer Status/Print

Settings item	Settings value	Explanation
Print Status Sheet		
	Configuration Status Sheet	Print a list of current printer settings. Use this to view all information at a glance.
	Network	Display current network settings details. Displayed details are the same as displayed in <b>General Settings - Network Settings - Network Status</b> .

## Using the Menu

## Enlarged Copy menu

Displayed when an Epson A3 or A4 scanner is connected to the printer. Set scaling in this menu to enable enlarged printing of the scanned documents.

 [“Making Enlarged Copies with an A3 or A4 Scanner” on page 96](#)

\*Default setting

Settings item	Settings value	Explanation
Copies	1 to 99	Specify the number of copies.
Color Mode	Black/White	Choose whether to do enlarged copying in color or in black and white.
	Color*	
Original Size	A4	Select the document size loaded on the scanner. The sizes available vary with the scanner. Sizes other than those shown here cannot be used.
	A5	
	A3	
	B5	
	B4	
	Letter	
	13 x 18 cm (5 x 7 in)	
Reduce/Enlarge		
Auto Fit Page	On*	Setting this to <b>On</b> means that the copy is enlarged so that the short edge of the document fits the width of the roll paper currently loaded in the printer.  If the short edge of the document is wider than the roll paper, this will be printed at actual size.  If the printer is unable to detect the width of the roll paper, then an error will occur when copying is started.
	Off	
Custom Size	Actual Size	Select the output size. To the left of each size, the percentage of enlargement of the selected document size is displayed.  A0, US E, and B1 display only SC-T5100 Series/SC-T5100N Series.  If the desired size is not on the list, then in <b>User-Defined</b> , set a desired size.
	A0	
	US E (34x44in)	
	JIS B1	
	A1	
	US D (22x34in)	
	JIS B2	
	US C (17x22in)	
A2		
User-Defined		
Density	-4 to 4 (0*)	Choose copy density.
Quality	Speed	Choose Copy Quality in view of image quality and print speed.
	Fine	

## Maintenance

# Maintenance

## Clear Print Head Clogs

If there are banding and unevenness, if text is faint, or if there are differences in the colors of images in the printed results, then the print head may be clogged. Check the nozzles, and if clogged, carry out print head cleaning. If these are still clogged even after cleaning has been carried out three times in a row, then perform Powerful Cleaning.

Confirm the following before performing cleaning.

- ❑ Ink is consumed during print head cleaning. Cleaning is not required except when there are problems with printing, or if nozzle clogging has been confirmed through a nozzle check. Powerful Cleaning consumes more ink than normal head cleaning.
- ❑ If the remaining ink level is low, prepare a new ink cartridge.
- ❑ If the remaining capacity in the Maintenance Box is low, prepare a new Maintenance Box.

## Checking for Clogged Print Head, and Cleaning

- 1 From the Home screen, touch **Settings - Maintenance - Print Head Nozzle Check**.
- 2 Touch **Start** to start print of a check pattern.  
When changing the paper source displayed on the start screen, touch **Paper Source**.
- 3 Check the printed check pattern for clogging.

### Example of clean nozzles

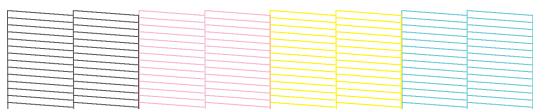

If none of the pattern is missing, then the print head nozzles are not clogged. Touch **○** to end the nozzle clogging check.

### Example of clogged nozzles

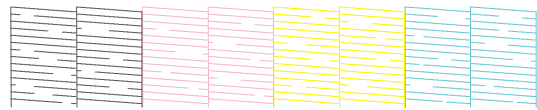

If the pattern has missing areas, touch **✖** to display the **Head Cleaning** screen. Proceed to the next step.

- 4 Touch **Start** to start cleaning.

When cleaning is complete, **Print the pattern?** will be displayed. Touch **Yes** to return to Step 2. Repeat Steps 2 to 4, and check if the problem has been resolved.

If the nozzles are still clogged after performing print head cleaning three times in a row, then perform **Powerful Cleaning**.

## Powerful Cleaning

Perform Powerful Cleaning if the nozzles are still clogged after performing print head cleaning three times in a row.

- 1 From the Home screen, touch **Settings - Maintenance - Powerful Cleaning**.

- 2 Touch **Start** to start cleaning.

When cleaning is complete, **Print the pattern?** will be displayed. Touch **Yes**, and on the next screen touch **Start** to print a check pattern. Check if the nozzle clogging has been removed.

If the nozzles are still clogged after performing Powerful Cleaning, turn off the printer and leave it overnight or longer. When left for some time, the clogged ink may dissolve.

If the nozzles are still clogged, contact your dealer or Epson Support.

## Maintenance

# Replacing Consumables

## Handling of Used Consumables

If using the printer in an office or other business, dispose of used consumables in accordance with laws and regulations, such as by contracting an industrial waste disposal company.

If using the printer in a domestic situation, place these in a plastic bag, then dispose of in accordance with laws and regulations as well as regional ordinances, and as directed by local government.

## Replacing Ink Cartridges

If any of the ink colors remaining amount falls below the minimum amount, printing will not be possible.

If an ink cartridge remaining amount falls below the minimum amount, you can continue printing after replacing the ink cartridge.

If the remaining ink amount drops yet printing is continued, then replacement of an ink cartridge during printing may be required. When replacing ink during a print job, you may see a difference in color depending on the drying conditions. When this is not permissible, we recommend first replacing the ink cartridge with a new one before printing. The removed ink cartridge can be installed again and used until the remaining amount falls below the minimum amount. However, if an ink cartridge with not much ink remaining is removed and reinstalled, it may not be usable because some ink is consumed to ensure the reliability of the printer.

Supported ink cartridges  [“Options and Consumable Products”](#) on page 154

### Important:

*Epson recommends the use of genuine Epson ink cartridges. Epson cannot guarantee the quality or reliability of non-genuine ink. The use of non-genuine ink may cause damage that is not covered by Epson's warranties, and under certain circumstances, may cause erratic printer behavior. Information about non-genuine ink levels may not be displayed, and use of non-genuine ink is recorded for possible use in service support.*

**1** From the Home screen, touch **Settings - Maintenance - Ink Cartridge(s) Replacement**.

**2** Touch **Start** and open the front cover.

The print head moves to the position at which the ink cartridge can be replaced.

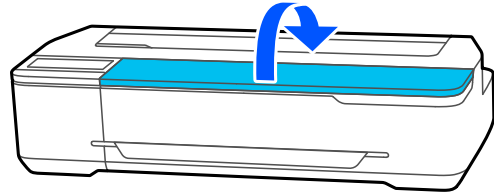

### Important:

*Do not move the print head by hand. Failure to observe this precaution could damage the printer.*

**3** Hold the new ink cartridge as shown below, and shake it up and down around 20 times (for 10 seconds).

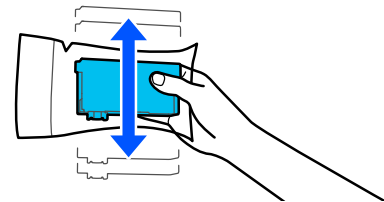

**4** Remove the new ink cartridge from the package and then peel off only the yellow tape.

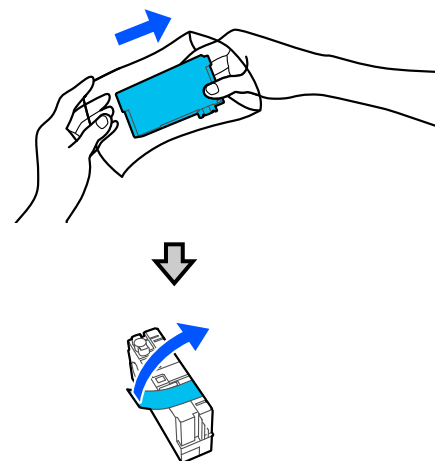

## Maintenance

**! Important:**

Do not touch the parts shown in the illustration. You may not be able to print properly.

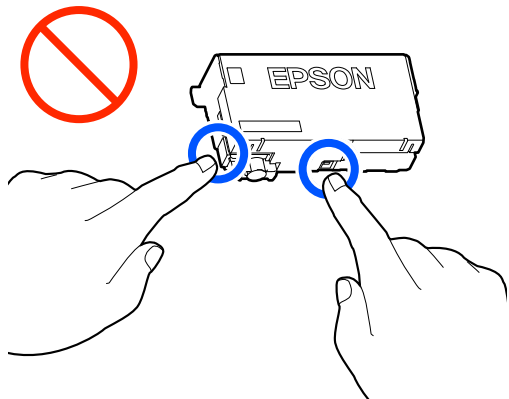

5

Open the cartridge cover.

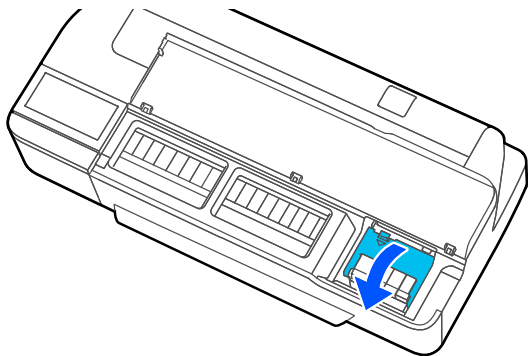

6

Remove the ink cartridge to replace.

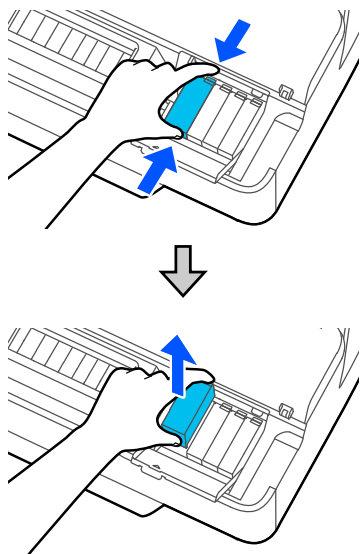

**! Important:**

Removed ink cartridges may have ink around the ink supply port, so be careful not to get any ink on the surrounding area when removing the cartridges.

7

Holding the new cartridge with the label facing up, and insert it perpendicularly.

Push the area marked "Push" firmly.

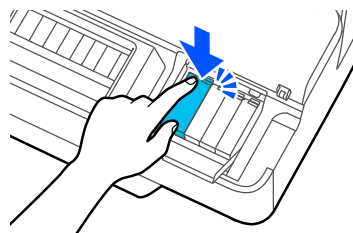

Repeat Steps 3 to 7 (Except step 5) to replace other ink cartridges.

**! Important:**

Install ink cartridges into all slots. You cannot print if any of the slots are empty.

8

Close the cartridge cover and front cover.

Ink charging starts. When **Replacement is complete.** is displayed, ink cartridge replacement is complete.

**! Important:**

Do not turn off the printer during ink charging. Doing so cause insufficient ink charge resulting in printing faint image or nothing.



## Maintenance

### Maintenance Box Replacement

If **The Maintenance Box is at the end of its service life.** is displayed, replace the Maintenance Box.

If **The Maintenance Box is nearing the end of its service life.** is displayed, ready a new Maintenance Box. Printing is possible until replacement is instructed.

Supported maintenance boxes  [“Options and Consumable Products”](#) on page 154

**!** **Important:**

*Do not replace the Maintenance Box while printing. Waste ink may leak.*

**Note:**

*You can replace the Maintenance Box while viewing the procedure on the screen. To see the guide, from the Home screen, touch **Settings - Maintenance - Replace Maintenance Box.***

- 1 Open the Maintenance Box cover on the back of the printer.

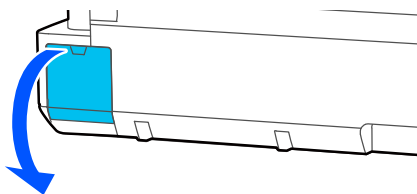

- 2 Pull out the Maintenance Box.

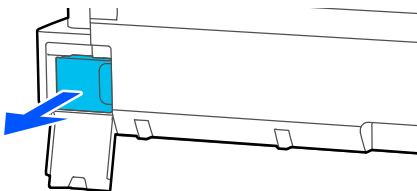

- 3 Place the used Maintenance Box in the clear bag included with the new Maintenance Box, and make sure that the zipper is closed tight.

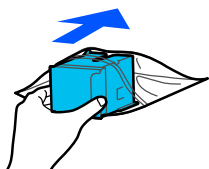

**!** **Important:**

*Until the fastener is closed securely, do not tilt the Maintenance Box. Waste ink may leak.*

- 4 Align the groove on the new Maintenance Box with the rail in the insertion location, and insert fully.

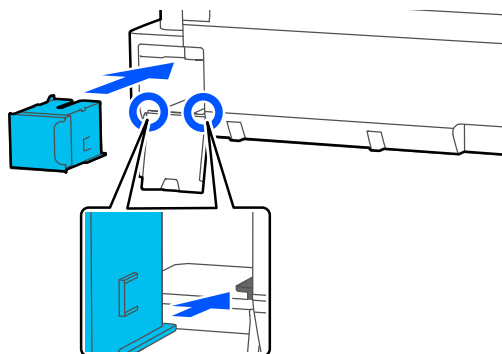

**!** **Important:**

*Do not touch the IC chip on the Maintenance Box. Doing so may prevent normal operation and printing.*

- 5 Close the Maintenance Box cover.

## Maintenance

### Replacing the Cutter

Replace the cutter when it is not cutting paper cleanly.

Supported cutters  [“Options and Consumable Products” on page 154](#)

Use a cross-head screwdriver to replace the cutter. Make sure you have a cross-head screwdriver with you before you start work.



**Caution:**

Store the cutter out of reach of children. The cutter's blade could cause an injury. Pay careful attention when replacing the cutter.



**Important:**

- ❑ Dropping the cutter, or knocking it against hard objects may chip the blade.
- ❑ The protective material and sheet is to protect the blade on the new cutter. Do not remove them until you are instructed to do so.

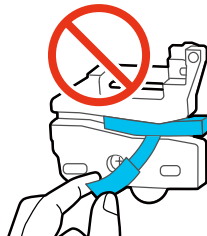

**1**

From the Home screen, touch **Settings - Maintenance - Replace Cutter**.

The Replace Cutter screen appears.

**2**

Touch **Start** and open the cutter cover.

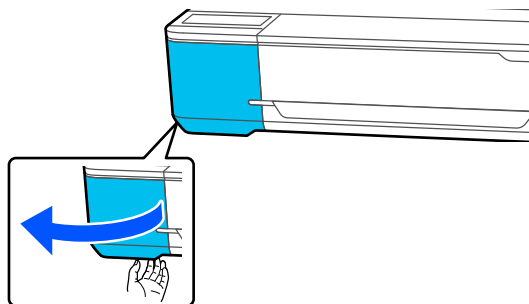

**3**

Loosen the screw holding the cutter in place using a cross-head screwdriver and pull the cutter straight out.

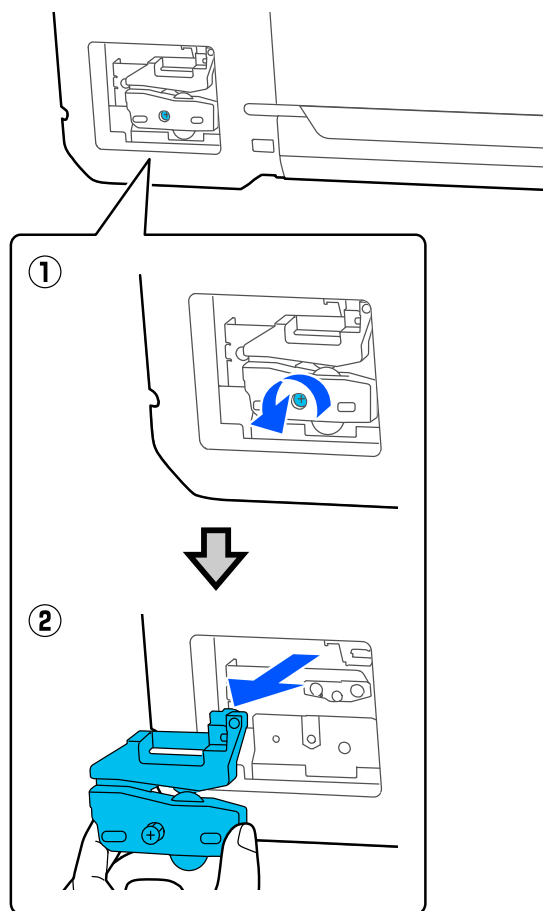

**Note:**

Place the used cutter in a plastic bag, then dispose of in accordance with regional ordinances, and as directed by local government.

**4**

Install the new cutter.

Insert the cutter so that the pin on the printer matches up with the hole on the cutter. Use a cross-head screwdriver to tighten down the screw to hold the cutter in place.

### Maintenance

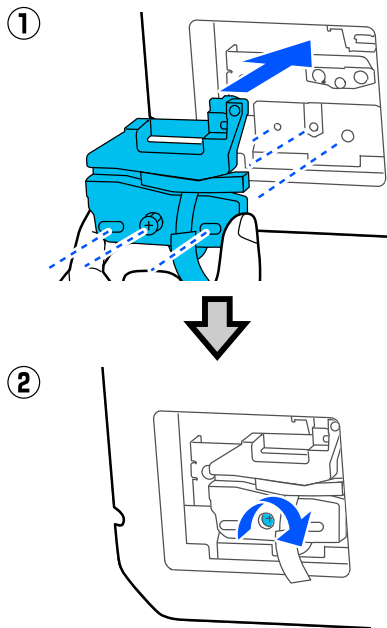

**!** **Important:**

*Screw the cutter firmly, otherwise the cut position may be slightly shifted or skewed.*

**5**

Remove the protective material shown below.

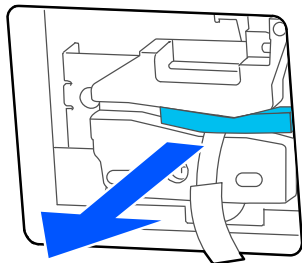

**!** **Important:**

*Do not remove the protective sheet with hands.*

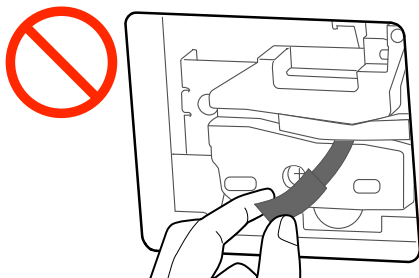

**6**

Touch **OK**.

The cutter will move, and the protective sheet will come off. Remove the protective sheet from the printer.

**7**

Close the cutter cover.

## Problem Solver

# Problem Solver

## What to do When a Message is Displayed

If the printer displays one of the messages shown below, refer to the solution listed and take the necessary steps.

Messages	What to do
Cannot recognize ink cartridges. Try installing again.	<ul style="list-style-type: none"> <li><input type="checkbox"/> Remove and reinsert the ink cartridge. If the message persists, insert a new ink cartridge (do not reinstall the cartridge that caused the error). <a href="#">☞ "Replacing Ink Cartridges" on page 135</a></li> <li><input type="checkbox"/> Condensation may occur in the ink cartridge. Leave it at room temperature for at least three hours before installing the ink cartridge again. <a href="#">☞ "Notes on handling ink cartridges" on page 19</a></li> </ul>
Ink is low.	<p>The ink is low. Ready a new ink cartridge. Printing is possible until replacement is instructed.</p> <p><a href="#">☞ "Options and Consumable Products" on page 154</a></p>
The maintenance box is not recognized. Install it correctly.	<p>Reinstall the Maintenance Box. If the message persists after reinstalling it, replace with a new Maintenance Box (do not reinstall the Maintenance Box that caused the error).</p> <p><a href="#">☞ "Maintenance Box Replacement" on page 137</a></p>
There is not enough space in maintenance box to perform head cleaning. You can continue printing until replacement is required.	<p>The Maintenance Box does not have enough capacity to store ink discharged in print head cleaning, therefore do not perform cleaning. To perform cleaning, replace the Maintenance Box with a new one. The used Maintenance Box may be reinstalled after cleaning is completed.</p> <p><a href="#">☞ "Maintenance Box Replacement" on page 137</a></p>
Command Error Check the printer driver setting.	<p>Touch <b>Cancel</b> to stop printing. Confirm that the printer driver you are using supports this printer.</p>
Scanner Error Refer to manual for details.	<ul style="list-style-type: none"> <li><input type="checkbox"/> Release the scanner transportation lock and turn the printer and scanner off and then on again.</li> <li><input type="checkbox"/> Turn the devices on and off several times. The scanner can be used after the message is no longer displayed.</li> </ul> <p>If this message appears on the LCD panel again, contact your dealer or Epson Support.</p>
Recovery Mode	<p>Firmware update has failed, so the printer has started in recovery mode. Use the procedure below to update the firmware again.</p> <p>(1) Connect a computer and the printer using a USB cable. (Updates during recovery mode cannot use a network connection.)</p> <p>(2) Download the latest firmware from the Epson website, and start update. Refer to the firmware download page for update methods.</p>

## Problem Solver

# When a Maintenance Call/Printer Error Occurs

Error messages	What to do
Maintenance Request Replace Parts Soon/End Of Parts Service Life XXXXXXXX	A part used in the printer is nearing the end of its service life. Contact your dealer or Epson Support and tell them the maintenance request code. You cannot clear a maintenance error until the part is replaced. A service call occurs if you continue to use the printer.
Printer Error Printer error. Turn the power off and on again. If the problem persists, contact Epson Support. XXXXXX	Turn off the printer, disconnect the power cable from the outlet and from the AC inlet on the printer, and then reconnect. Turn on the printer again multiple times. If the same error is displayed on the LCD panel, contact your dealer or Epson Support for assistance. Tell them the error code is "XXXXXX".

## Problem Solver

# Troubleshooting

## You cannot print (because the printer does not work)

### The printer does not turn on.

■ **Is the power cable plugged into the electrical outlet or the printer?**

Make sure the power cable is securely plugged into the printer.

■ **Is there a problem with the power outlet?**

Make sure your outlet works by connecting the power cable for another electric product.

### The printer turns off automatically.

■ **Is the automatic power off configured?**

To prevent the printer turning off automatically, select **Off**.

["General Settings - Basic Settings" on page 115](#)

### The printer driver is not installed properly (Windows).

■ **Is the icon for this printer displayed in the Devices and Printers / Printers / Printers and Faxes folder?**

- Yes  
The printer driver is installed. See the "The printer is not communicating with the computer" section.
- No  
The printer driver is not installed. Install the printer driver.

■ **Does the printer port setting match the printer connection port?**

Check the printer port.

Click the **Port** tab in the printer Properties dialog and check the option selected for **Print to the following port(s)**.

- USB: **USBxxx** (x stands for the port number) for the USB connection
- Network: The correct IP address for the network connection

If it is not indicated, the printer driver is not installed correctly. Delete and reinstall the printer driver.

["Uninstalling Software" on page 26](#)

### The printer driver is not installed properly (Mac).

■ **Is the printer added to the printer list?**

Select **System Preferences > Printers & Scanners** (or **Print & Fax**) from the Apple menu.

If the printer name is not displayed, add the printer.

["How to Select the Dedicated Printer Driver for This Printer" on page 54](#)

### The printer is not communicating with the computer.

■ **Is the cable plugged in properly?**

Confirm that the interface cable is securely connected to both the printer port and the computer. Also, make sure the cable is not broken nor bent. If you have a spare cable, try connecting with the spare cable.

■ **Does the interface cable specification match the specifications for the computer?**

Make sure the interface cable specifications match the specifications for the printer and the computer.

["System Requirements" on page 169](#)

## Problem Solver

### ■ When using a USB hub, is it being used correctly?

In the USB specification, daisy-chains of up to five USB hubs are possible. However, we recommend that you connect the printer to the first hub connected directly to the computer. Depending on the hub you are using, the operation of the printer may become unstable. If this should occur, plug the USB cable directly into your computer's USB port.

### ■ Is the USB hub recognized correctly?

Make sure the USB hub is recognized correctly on the computer. If the computer correctly detects the USB hub, disconnect all USB hubs from the computer and connect the printer directly to the computer USB port. Ask the USB hub manufacturer about USB hub operation.

## You cannot print under the network environment.

### ■ Are the network settings correct?

Ask your network administrator for the network settings.

### ■ Connect the printer directly to the computer using a USB cable, and then try to print.

If you are able to print via USB, there is a problem with network settings. Ask your system administrator, or refer to the manual for your network system.

## Printing from iPhone or iPad is not possible.

### ■ Check printer settings.

- Connect the iPhone or iPad to the same network (SSID) as the printer.
- In Web Config, enable AirPrint settings.  
 ["How to Use Web Config" on page 24](#)

## The printer has an error.

### ■ View the message displayed in the control panel.

 ["What to do When a Message is Displayed" on page 140](#)

## The printer stops printing.

### ■ Is the status of print queue Pause? (Windows)

If you stop printing or the printer stops printing because of an error, the print queue enters a **Pause** status. You cannot print in this status.

Double-click the printer icon in the **Devices and Printers, Printers**, or **Printers and Faxes** folder; if printing is paused, open the **Printer** menu and clear the **Pause** check box.

### ■ Does the current printer status show Paused? (Mac)

Open the status dialog for your printer and check whether printing is paused.

- (1) Select **System Preferences > Printers & Scanners** (or **Print & Fax**) > **Open Print Queue** from the **Apple** menu.
- (2) Double-click the icon for any printer that is **Paused**.
- (3) Click **Resume Printer**.

## Problem Solver

### Your problem is not listed here.

#### ■ **Decide whether the trouble is caused by the printer driver or the application. (Windows)**

Perform a test print from the printer driver so that you can check that the connection between the printer and computer is correct and the printer driver settings are correct.

- (1) Make sure that the printer is turned on and in ready status, and load A4 or larger paper.
- (2) Open the **Devices and Printers, Printers**, or **Printers and Faxes** folder.
- (3) Right-click the printer icon, and select **Properties**.
- (4) In the Properties dialog, select the **General** tab and click **Print Test Page**.

After a while the printer starts to print a test page.

- If the test page is printed correctly, the connection between the printer and computer is correct. Go to the next section.
- If the test page is not printed correctly, check the items above again.  
 ["You cannot print \(because the printer does not work\)" on page 142](#)

The "Driver Version" shown on the test page is the version number of the Windows internal driver. This differs from the Epson printer driver version that you installed.

---

### The printer sounds like it is printing, but nothing prints

#### ■ **Confirm the printer operation.**

Print a nozzle check pattern.

 ["Checking for Clogged Print Head, and Cleaning" on page 134](#)

If there are no gaps in the nozzle check pattern, then the printer is not damaged. Check the following item.

#### ■ **Is the message Motor self adjustment running, displayed on the control panel's screen?**

The printer adjusts the internal motor. Wait for a while without turning off the printer.



**Problem Solver**

**The prints are not what you expected**

If the following problems with print quality occur, then respond by following the process flow on this page.

**Horizontal or vertical banding**



**Duplicated ruled lines or warped lettering**

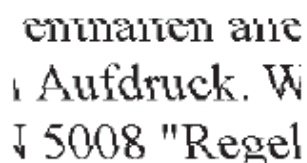

**Wrinkling, smearing, or uneven coloring**



<p><b>Check the paper</b></p>	<ul style="list-style-type: none"> <li><input type="checkbox"/> Check that the paper is compatible with the printer, and that there are no wrinkles, folds, or bending.                     <ul style="list-style-type: none"> <li><a href="#">"Epson Special Media" on page 154</a></li> <li><a href="#">"Supported Commercially Available Paper" on page 160</a></li> <li><a href="#">"Notes on Loading the Paper" on page 27</a></li> </ul> </li> <li><input type="checkbox"/> Check that the paper type setting matches the loaded paper, and if not, change it.                     <ul style="list-style-type: none"> <li><a href="#">"Setting Loaded Paper" on page 39</a></li> </ul> </li> </ul>
-------------------------------	--



**If print results do not improve**

<p><b>Perform Media Adjust</b></p>	<p>Paper settings are optimized for the paper loaded.</p> <p><a href="#">"Optimizing Paper Settings (Media Adjust)" on page 43</a></p>
------------------------------------	--



**If print results do not improve**

<p><b>Check for clogged print head, and perform cleaning</b></p>	<p>Check for print head nozzle clogging, and if these are clogged, carry out cleaning.</p> <p><a href="#">"Checking for Clogged Print Head, and Cleaning" on page 134</a></p>
--	---



**If nozzle clogging does not improve after repeating cleaning 3 times**

<p><b>Perform Powerful Cleaning</b></p>	<p>Perform <b>Powerful Cleaning</b>.</p> <p><a href="#">"Powerful Cleaning" on page 134</a></p>
---	---

Refer to the following page onwards for other problems with print quality and ways to resolve these.

## Problem Solver

### Ink drips



#### ■ Are the print head nozzles clogged?

Perform print head cleaning. From the printer menu, touch **Settings - Maintenance - Head Cleaning**.

### Fine lines in drawings are not printed

#### ■ Is a suitable resolution set?

Try the following measures.

- In your application software, set the resolution to 600 dpi.
- Confirm that the data paper size is correctly set in the printer driver document size, and remedy if different.
- If PDF, print directly from the source data for that PDF.
- In the printer driver, select **Emphasize Thin Lines**. **Emphasize Thin Lines** is displayed by deselecting Simple Settings in the Print Quality field on the Printer Settings screen.

### Vertical unevenness when printing from the auto sheet feeder

#### ■ Are the auto sheet feeder rollers dirty?

A dirty roller may cause uneven vertical lines on the print results. To remedy, clean the rollers. If vertical lines appear on glossy paper, we recommend that instead of using the auto sheet feeder, you feed individual sheets from Cut Sheet(1 sheet) for printing.

["Smearing occurs on printed matter from the auto sheet feeder." on page 148](#)

["Loading Cut Sheet\(1 sheet\)" on page 37](#)

### Differences in color/light/dark

If there are differences in color/light/dark, then handle these by following the process below.

["The prints are not what you expected" on page 145](#)

If these measures do not resolve the issue, check the following items.

#### ■ Is the Color Density setting appropriate?

If you feel that lines in drawings are too light, then on the printer driver Advanced screen, click **Paper Configuration**, and increase the ink density.

Conversely, on tracing paper if the ink density is too high, then either reduce the ink density, or in printer Paper Type settings, select **Tracing Paper <LowDuty>** and print.

#### ■ Are you using a genuine Epson ink cartridge?

This printer is developed for use with Epson ink cartridges. If you use non-Epson ink cartridges, printouts may be faint, or the color of the printed image may be changed because the remaining ink level is not correctly detected. Be sure to use the correct ink cartridge.

#### ■ Are you using an old ink cartridge?

The print quality drops when an old ink cartridge is used. Replace the old ink cartridge with a new one. We recommend using all the ink in the cartridge before the expiry date printed on the package (within 6 months of installation in the printer).

#### ■ Have you tried changing the print quality settings?

In the printer driver **Printer Settings-Print Quality**, select **Print with High Quality** and try printing. If this is not selected, this places priority on speed, however this can adversely impact print quality to some extent.

#### ■ Is color management enabled?

Enable color management.

["Color Management Printing" on page 72](#)

## Problem Solver

### ■ Have you compared the printing result with the image on the display monitor?

Since the monitor and the printer produce colors differently, printed colors will not always match on-screen colors perfectly.

### ■ Did you open the front cover while printing?

If the front cover is opened while printing, the print head stops suddenly, causing unevenness in color. Do not open the front cover while printing.

## The color is not exactly the same as another printer.

### ■ Colors vary depending on the printer type due to each printer's characteristics.

Because inks, printer drivers, and printer profiles are developed for each printer model, the colors printed by different printer models are not exactly the same.

You can achieve similar colors with the same color adjustment method or the same gamma setting by using the printer driver.

 ["Correct color and print" on page 68](#)

## The print is not positioned properly on the media.

### ■ Have you specified the print area?

Check the print area in the settings of the application and the printer.

### ■ Is the Document Size setting correct?

If the option selected for **Document Size** or **Paper Size** in the printer driver does not match the paper loaded in the printer, the print may not be in the correct position or some of the data may not be printed. In this case, check the print settings.

### ■ Is the paper skewed?

If **Off** is selected for **Detect Paper Meandering** in the Printer Settings menu, printing will continue even if the paper is skewed, resulting in data being printed off the edges of the paper. In the Printer Settings menu, set **Detect Paper Meandering** to **On**.

 ["General Settings - Printer Settings" on page 117](#)

### ■ Is the roll paper margin set wide?

If margins narrower than the margins set in the roll paper **Advanced Media Setting - Top/Bottom Margins** menu are set in the application software, then priority is given to the printer settings.

 ["Roll Paper menu" on page 109](#)

## Vertical ruled lines are misaligned.

### ■ Has Media Adjust been carried out?

Confirm that paper type settings that match the paper are selected, and perform Media Adjust.

 ["Setting Loaded Paper" on page 39](#)

 ["Optimizing Paper Settings \(Media Adjust\)" on page 43](#)

### ■ After media adjust, does the same problem occur?

In the printer driver Printer Settings screen, deselect **Simple Settings** in the Print Quality field. Select **Level - Max Quality**, deselect **High Speed**, and try printing.

However, printing may take some time.

Bidirectional printing moves the print head left and right while printing, so if the print head is misaligned (with gaps), ruled lines may be printed as misaligned.

## The printed surface is scuffed or soiled.

### ■ Is the paper too thick or too thin?

Check that the paper specifications are compatible with this printer.

 ["Epson Special Media Table" on page 157](#)

 ["Supported Commercially Available Paper" on page 160](#)

## Problem Solver

### ■ Is the paper wrinkled or creased?

Do not use old paper or paper with creases in it. Always use new paper.

### ■ Is the paper wavy or curled?

Changes in temperature and humidity may cause paper to become wavy or curled which can cause scratching.

Check the following points.

- Insert the paper just before printing.
  - Do not use wavy or curled paper.  
For roll paper, cut off the wavy or curled parts and then load it again.  
For cut sheets, use new paper.
-  ["Notes on Loading the Paper" on page 27](#)

### ■ Is the print head scuffing the printed surface?

Enable the Thick Paper function, and try printing. From the Home screen, touch **Settings - Printer Settings - Thick Paper - Accept**.

If, after enabling the Thick Paper function, smearing is not improved, then register as a custom paper, and increase the Platen Gap value to its maximum value.

Perform custom paper registration from **Settings - General Settings - Printer Settings - Custom Paper Setting**.

 ["General Settings - Printer Settings" on page 117](#)

Perform Platen Gap from the Home screen Roll Paper Information field - **Advanced Media Setting - Platen Gap**.

 ["Roll Paper menu" on page 109](#)

### ■ Is the print head scuffing the edge of the paper?





If smearing or soiling occurs on the edge of the roll paper, from the Home screen touch the roll paper information field - **Advanced Media Setting - Top/Bottom Margins**, change the edge setting to 45 mm, and try printing.

### ■ Is the print head scuffing the trailing edge of the paper?

Depending on the paper usage, storage conditions, and the content of the print data, the bottom edge may be scuffed when printing. In this situation it is best to create your data with a wider bottom margin.

## The same smearing or soiling occurs on the printed surface of both roll paper and cut paper.

Follow the steps below to clean the roller by feeding plain paper.

- 1** Turn on the printer, and load it with widest available roll paper.  
 ["Loading Roll Paper" on page 28](#)
- 2** Touch **Paper Setting - Roll Paper - Feed/Cut Paper** from the Home screen.
- 3** Touch and hold the  (Forward) button until the paper is no longer marked.  
Paper is fed while the  (Forward) button is touched. If the paper is not soiled, cleaning is complete.
- 4** Touch the  (Cut) button to cut the paper.

## Smearing occurs on printed matter from the auto sheet feeder.

Soiling or uneven color may appear on the printed surface when printing on paper supplied from the auto sheet feeder. This occurs in particular with glossy paper.

If vertical soiling appears on glossy paper, we recommend that instead of using the auto sheet feeder, you feed individual sheets from Cut Sheet(1 sheet) for printing.

 ["Loading Cut Sheet\(1 sheet\)" on page 37](#)

Follow the steps below to feed and eject plain paper to clean the auto sheet feeder roller.

## Problem Solver

- 1 Turn on the printer, and load a number of sheets of A3 size plain paper in the auto sheet feeder.  
[🔗 "Loading Paper in the Auto Sheet Feeder" on page 34](#)
- 2 From the Home screen, touch **Settings - Maintenance - Paper Guide Cleaning**.
- 3 Touch **Start**.  
The paper is ejected.
- 4 Confirm if there is any soiling on the ejected paper.
  - If there is soiling: Touch and hold **Run Again** until the soiling is gone.
  - If there is no soiling: Touch **Done** to complete roller cleaning.

### The paper is creased.

- **Are you using the printer at normal room temperature?**  
Epson special media should be used at normal room temperature (temperature: 15 to 25°C, humidity: 40 to 60%). For information about paper such as thin paper from other manufacturers that requires special handling, see the documentation supplied with the paper.
- **Is there a gap between both edges of the roll paper and the flanges?**  
Confirm that the spindle flanges are right up against both edges of the roll paper, with no gaps. If there are any gaps, then the paper is fed at an angle, and this may result in wrinkling.  
[🔗 "Loading Roll Paper" on page 28](#)
- **Has Media Adjust been carried out?**  
Confirm that paper type settings that match the paper being used, and perform Media Adjust.  
[🔗 "Setting Loaded Paper" on page 39](#)  
[🔗 "Optimizing Paper Settings \(Media Adjust\)" on page 43](#)

- **Is the roll paper tension weak?**

If wrinkles occur on the roll paper, increase the paper tension settings. In the roll paper information field - **Advanced Media Setting - Back Tension**, select **High** or **Extra High**.

### The reverse side of the printed paper is soiled.

- **Is ink dry on the printed surface?**

Depending on the printing density and media type, the ink may take a while to dry. Do not stack the paper until the printed surface is dry.

Additionally, setting the drying time on the printer in **Roll Paper - Advanced Media Setting - Drying Time - Drying Time per Page** to a longer time will stop post-print processing (ejection, cutting), waiting for the paper to dry naturally.

[🔗 "Roll Paper menu" on page 109](#)

### Blurred text, lines, and images

- **Is the Media Type setting correct?**

Confirm that the paper type selected with the printer matches the paper being used, and that the printer driver Media Type settings are **Use Printer Settings**. The amount of ink to be fired is controlled according to the media type. If the settings do not match the paper loaded, too much ink may be fired.

[🔗 "Setting Loaded Paper" on page 39](#)

- **Is the Color Density setting appropriate?**

On the printer driver Advanced screen, click **Paper Configuration**, and decrease the ink density. The printer may be printing with much ink for some paper. We recommend that black and color densities be decreased similarly.

- **Are you printing on tracing paper?**

If too much ink is discharged, on the printer driver Advanced screen, click **Paper Configuration**, and decrease the ink density. Alternatively, changing **Paper Type** to **Tracing Paper <LowDuty>** may result in an improvement.

## Problem Solver

### Feeding or ejecting problems

#### Unable to feed or eject paper.

##### ■ Is the paper loaded in the correct position?

See the following for the correct paper loading positions.

 ["Loading Roll Paper" on page 28](#)

 ["Loading Paper in the Auto Sheet Feeder" on page 34](#)

 ["Loading Cut Sheet\(1 sheet\)" on page 37](#)

##### ■ Is the paper loaded in the correct direction?

Load cut sheets vertically. If they are not loaded in the correct direction, the paper may not be recognized and an error may occur.

 ["Loading Paper in the Auto Sheet Feeder" on page 34](#)

 ["Loading Cut Sheet\(1 sheet\)" on page 37](#)

##### ■ Is the paper wrinkled or creased?

Do not use old paper or paper with creases in it. Always use new paper.

##### ■ Is the paper damp?

Do not use paper that is damp. Also, Epson special media should be left in the bag until you intend to use it. If it is left out for a long time, the paper curls up and gets damp so that it does not feed properly.

##### ■ Is the paper wavy or curled?

If changes in temperature and humidity cause paper to become wavy or curled, the printer may not be able to recognize the paper size correctly.

Check the following points.

- Insert the paper just before printing.
- Do not use wavy or curled paper.  
For roll paper, cut off the wavy or curled parts and then load it again.  
For cut sheets, use new paper.

 ["Notes on Loading the Paper" on page 27](#)

##### ■ Are the edges of the roll paper uneven?

Loading roll paper with the right and left edges uneven may cause paper feeding problems or paper meandering may occur during printing. Rewind the paper to make the edges even before using roll paper or use roll paper with no problem.

 ["Notes on Loading the Paper" on page 27](#)

##### ■ Is the paper too thick or too thin?

Check that the paper specifications are compatible with this printer.

 ["Epson Special Media" on page 154](#)

 ["Supported Commercially Available Paper" on page 160](#)

##### ■ Are you using the printer at normal room temperature?

Epson special media should be used at normal room temperature (temperature: 15 to 25°C, humidity: 40 to 60%). For information about paper from other manufacturers, see the documentation supplied with the paper.

##### ■ Is paper jammed in the printer?

Open the front cover of the printer and check that there are no paper jams or foreign objects in the printer. If paper is jammed, see "Roll paper jam" or "Cut sheets jam" below and clear the jammed paper.

**Problem Solver**

**Paper does not collect in the paper basket or is creased or folded**

■ **Does the print job require a lot of ink, or is the humidity of the workplace high?**

Depending on the job and the work environment, paper may not collect in the paper basket. Take the following measures as appropriate.

- ❑ Paper does not collect in the paper basket: Use your hands to lightly press the paper into the paper basket as it is ejected from the printer.
- ❑ The paper folds after it has been cut automatically: Select manual cutting and take the paper in both hands after it is cut.
- ❑ The paper creases and does not collect well in the paper basket: Resume printing after closing the paper basket. Before the paper ejected from the printer touches the floor, take it in both hands close to the paper eject slot and continue to lightly support it until printing is complete.

**Roll paper jam**

To remove jammed paper, follow the steps below:

- 1** Open the cut sheet cover.

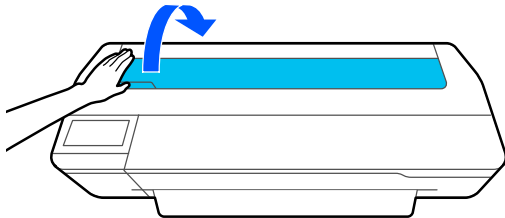

- 2** Release the central lock, and then open the roll paper cover.

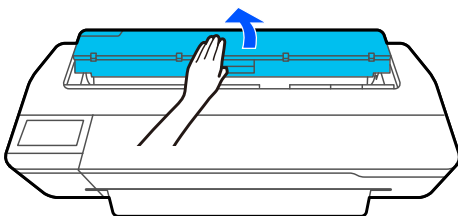

- 3** Cut the top portion of any torn or crinkled areas using a commercially available cutter.

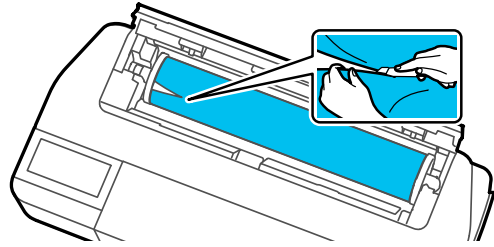

- 4** Close the roll paper cover and cut sheet cover.

- 5** When ejecting paper from the front, grasp the paper with both hands, and slowly pull it out towards you.

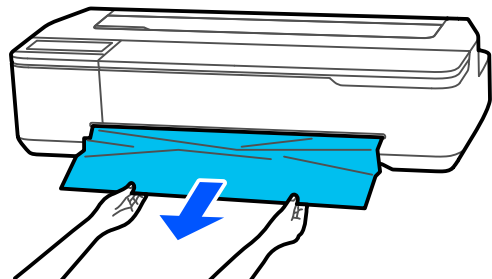

- 6** Open the front cover, remove the jammed paper, then close the front cover.

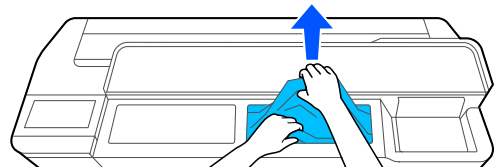

**! Important:**

*Do not touch the print head. If you touch the print head with your hand, static electricity may cause a malfunction.*

- 7** If **Then turn the power off and on again.** is displayed on the screen, turn off the printer, and then turn it back on.

After removing the paper, reload the paper and restart printing.

[“Loading Roll Paper” on page 28](#)



## Problem Solver

### **Important:**

Before you reload the roll paper, cut the edge straight horizontally. Cut any wavy or creased sections.

If there are any wrinkles on the edge, then paper may not be fed, or it may jam.

## Cut sheets jam

To remove jammed paper, follow the steps below:

- 1 Open the front cover.

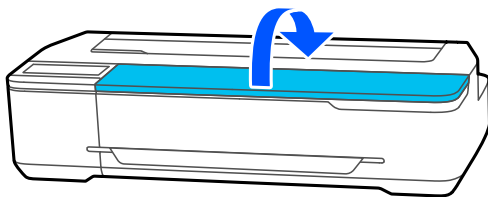

- 2 When ejecting paper from the front, grasp the paper with both hands, and slowly pull it out towards you.

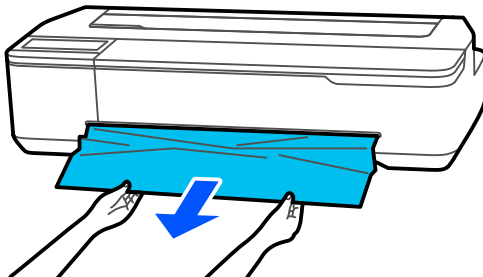

- 3 Remove the jammed paper, then close the front cover.

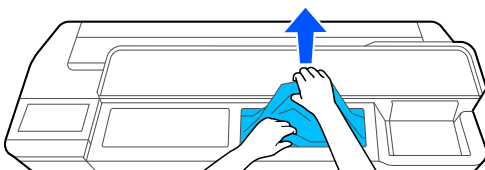

### **Important:**

Do not touch the print head. If you touch the print head with your hand, static electricity may cause a malfunction.

- 4 If **Then turn the power off and on again.** is displayed on the screen, turn off the printer, and then turn it back on.

After removing the paper, reload the paper and restart printing.

 [“Loading Paper in the Auto Sheet Feeder” on page 34](#)

 [“Loading Cut Sheet\(1 sheet\)” on page 37](#)

## Others

### The control panel display keeps turning off.

#### ■ Is the printer in sleep mode?

Sleep mode is exited if a print job is received or the screen of the control panel is touched. The delay before entering sleep mode can be changed from the Basic Settings menu.

 [“General Settings - Basic Settings” on page 115](#)

### Color ink runs out quickly even when printing in the Black&White mode or when printing black data.

#### ■ Color ink may be consumed even if in printing in black and white mode, or printing black data.

#### ■ Color ink is also consumed during the print head cleaning process.

When performing **Head Cleaning** or **Powerful Cleaning**, ink of all colors will be consumed even if black and white mode is selected.

### The paper is not cut cleanly.

#### ■ Replace the cutter.

If the paper is not cut cleanly, replace the cutter.

 [“Replacing the Cutter” on page 138](#)



## Problem Solver

### A light is visible inside the printer.

- **This is not a failure.**  
The light is a light inside the printer.

### The administrator password has been lost

- Should you forget the administrator password, contact your dealer or Epson Support.

### Print head is automatically cleaned

- To ensure print quality, the printer may automatically perform head cleaning when the printer is turned on or before starting printing.

### The printer turned off due to a power cut

- **Turn off the printer, and then turn it back on.**  
When the printer is not turned off normally, the print head may not be capped correctly. If the print head is left uncapped for a long time, the print quality may decline.  
When you turn on the printer, capping is performed automatically after a few minutes.

## Appendix

# Appendix

## Options and Consumable Products

The following options and consumable products are available for use with your printer. (As of April, 2018)

For the latest information, see the Epson Web site.

### Epson Special Media

 [“Epson Special Media Table” on page 157](#)

### Ink cartridges

Epson recommends the use of genuine Epson ink cartridges. Epson cannot guarantee the quality or reliability of non-genuine ink. The use of non-genuine ink may cause damage that is not covered by Epson's warranties, and under certain circumstances, may cause erratic printer behavior.

Information about non-genuine ink levels may not be displayed, and use of non-genuine ink is recorded for possible use in service support.

Printer model	Ink color	Product Number		
		80ml	50ml	26ml
SC-T5100	Black	T40D1	T40C1	-
SC-T3100	Cyan	-	T40D2	T40C2
SC-T5100N	Magenta	-	T40D3	T40C3
SC-T3100N	Yellow	-	T40D4	T40C4
SC-T5130	Black	T40B1	T40A1	-
SC-T3130	Cyan	-	T40B2	T40A2
SC-T3130N	Magenta	-	T40B3	T40A3
	Yellow	-	T40B4	T40A4
SC-T5160	Black	T40U1	T40S1	-
SC-T3160	Cyan	-	T40U2	T40S2
SC-T5160N	Magenta	-	T40U3	T40S3
SC-T3160N	Yellow	-	T40U4	T40S4

**Appendix**

Printer model	Ink color	Product Number		
		80ml	50ml	26ml
SC-T5180	Black	T40H1	T40G1	-
SC-T5180N	Cyan	-	T40H2	T40G2
SC-T3180N	Magenta	-	T40H3	T40G3
	Yellow	-	T40H4	T40G4

**Others**

Product	Part number	Explanation
Maintenance Box	S210057	Maintenance Box to be used for replacement when the previous Maintenance Box has insufficient capacity remaining. <a href="#">📄 "Maintenance Box Replacement" on page 137</a>
Auto Cutter Spare Blade (except for SC-T5180 / SC-T5180N / SC-T3180N)	S210055	<a href="#">📄 "Replacing the Cutter" on page 138</a>
Auto Cutter Spare Blade (for SC-T5180 / SC-T5180N / SC-T3180N)	S210056	
Stand (36") (except for SC-T5180 / SC-T5180N / SC-T3180N)	C12C933091	Dedicated stand with a paper basket for models without a stand. Select the width in accordance with a model you are using.
Stand (36") (for SC-T5180 / SC-T5180N / SC-T3180N)	C12C933101	
Stand (24") (except for SC-T5180 / SC-T5180N / SC-T3180N)	C12C933151	
Stand (24") (for SC-T5180 / SC-T5180N / SC-T3180N)	C12C933161	

**Appendix**

<b>Product</b>	<b>Part number</b>	<b>Explanation</b>
Roll Feed Spindle (36") (except for SC-T5180 / SC-T5180N / SC-T3180N)	C12C933131	This is the same as the roll paper spindle supplied with the printer. Select the width in accordance with a model you are using.
Roll Feed Spindle (36") (for SC-T5180 / SC-T5180N / SC-T3180N)	C12C933141	
Roll Feed Spindle (24") (except for SC-T5180 / SC-T5180N / SC-T3180N)	C12C933211	
Roll Feed Spindle (24") (for SC-T5180 / SC-T5180N / SC-T3180N)	C12C933221	

## Appendix

# Supported Media

We recommend you use the following Epson special media for high-quality printing results. Refer to the following for supported commercially available paper.

 [“Supported Commercially Available Paper” on page 160](#)

---

## Epson Special Media Table

Epson paper supported by this printer is described below. (As of April, 2018).

Not all paper types and sizes are available in all countries or regions.

**Note:**

*The paper names in the following table are displayed by the paper type settings in the menu of the printer driver or the printer. Some parts of paper names may be omitted.*

*Example): Premium Glossy Photo Paper (170) may be abbreviated to Premium Glossy 170.*

## Roll Paper

Paper Name	Size
Singleweight Matte Paper	420 mm/A2 432 mm/17 in. 515 mm/B2 594 mm/A1 610 mm/24 in. 728 mm/B1* 914 mm/36 in.*
Doubleweight Matte Paper	594 mm/A1 610 mm/24 in. 728 mm/B1* 914 mm/36 in.*
Premium Glossy Photo Paper (170)	420 mm/A2 594 mm/A1 610 mm/24 in. 728 mm/B1* 914 mm/36 in.*

### Appendix

Paper Name	Size
Premium Semigloss Photo Paper (170)	420 mm/A2 594 mm/A1 610 mm/24 in. 728 mm/B1* 914 mm/36 in.*
Enhanced Adhesive Synthetic Paper	610 mm/24 in. 914 mm/36 in.*
Enhanced Low Adhesive Synthetic Paper	610 mm/24 in. 914 mm/36 in.*

\* Available only with SC-T5100 Series.

### Cut Sheet

Paper Name	Size*	Auto Sheet Feeder	
		Availability	Loadable Number of Sheets
Photo Quality Inkjet Paper	A4 Letter Legal A3	✓	5
	Super A3/B SuperB A2 US-C	-	-
Archival Matte Paper	A4 Letter A3	✓	5
	Super A3/B SuperB A2 US C	-	-
Photo paper Glossy	A4 Letter A3	✓	5
	A3+ SuperB US-B	-	-

**Appendix**

Paper Name	Size*	Auto Sheet Feeder	
		Availability	Loadable Number of Sheets
Premium Glossy Photo Paper	A4 Letter 11 x 14 in. A3	✓	5
	Super A3/B SuperB A2 US-C	-	-
Premium Semigloss Photo Paper	A4 Letter A3	✓	5
	Super A3/B SuperB A2 US-C	-	-
Premium Luster Photo Paper	A4 Letter A3	✓	5
	A2 US-C	-	-

## Appendix

### Supported Commercially Available Paper

This printer supports the following paper specifications for non-Epson media.

 **Important:**

- Do not use paper that is wrinkled, scuffed, torn, or dirty.
- Commercially available paper corresponding to the paper types in the table can be loaded in and fed through the printer as long as they meet the following specifications, however Epson cannot guarantee the print quality.
- Commercially available paper types not in the table can be loaded in the printer as long as they meet the following specifications, however Epson cannot guarantee the feed and print quality.

#### Roll Paper

Paper Type	Plain paper, coated paper, photo paper, tracing paper, matte film
Roll core size	2 inch
Roll paper outer diameter	110 mm or less
Paper width	SC-T5100 Series/SC-T5100N Series: 329 to 914 mm (36 inch) SC-T3100 Series/SC-T3100N Series: 329 to 610 mm (24 inch)
Paper thickness	0.05 to 0.21 mm
Roll weight	3 kg or less

#### Cut Sheet (Auto Sheet Feeder)

Paper type	Plain paper, coated paper, photo paper
Paper size	A4 to A3
Paper thickness	0.12 to 0.27 mm

The maximum number of sheets that can be set in the auto sheet feeder is 50 for plain paper, and 5 for other types of paper.

However, depending on the thickness of the paper, feeding paper may fail even if the numbers of sheets lower than these are set. In these cases, reduce the number of sheets of paper loaded.

#### Cut Sheet (1 Sheet)

Paper type	Plain paper, coated paper, photo paper, tracing paper, matte film
Paper width	SC-T5100 Series/SC-T5100N Series: 210 to 914 mm (36 inch) SC-T3100 Series/SC-T3100N Series: 210 to 610 mm (24 inch)



**Appendix**

Length	279.4 mm (Letter) to 1,189 mm
Paper thickness	0.12 to 0.27 mm

## Appendix

### Before Printing on Commercially Available Paper

When using commercially available paper, select the paper type setting that matches to the paper from the following settings.



- Plain paper
- Coated Paper(Generic)
- Photo Paper(Generic)
- Tracing Paper
- Tracing Paper <LowDuty>
- Matte Film

If there is banding, wrinkling or smearing, or uneven color on the printing results, perform **Media Adjust**.

 [“Optimizing Paper Settings \(Media Adjust\)” on page 43](#)

### When using Commercially Available Synthetic, Canvas or Film-type Paper

Before printing, carry out one of the following.

- Add as a new paper type setting (register as custom paper), and carry out media adjust.  
From the Home screen, touch **Settings - General Settings - Printer Settings - Custom Paper Setting**, and register a custom paper. After registering the paper, perform Media Adjust. Paper adjustment results will be saved as the newly added paper type settings.  
Refer to the following menu for details on custom paper settings.  
 [“General Settings - Printer Settings” on page 117](#)
- Select the paper type from the following Epson Special Media settings, and perform Media Adjust.  
Enhanced Adhesive Syn., Enhanced Low Adh. Syn., Heavyweight Polyester, Glossy Film2  
By performing the Media Adjust, paper settings for Epson Special Media will be overwritten by the settings for the paper you use.  
 [“Optimizing Paper Settings \(Media Adjust\)” on page 43](#)

**Note:**

*Test the print quality with this printer before purchasing a large amount of paper.*

Appendix

# Printable area

This section describes the printable areas for the printer.

If the print range settings in application software are larger than the following printer printable areas, sections beyond the specified margins are not printed.

## Roll Paper

The gray area in the illustration below shows the printable area.

The arrow in the illustration indicates the direction of the ejected paper.

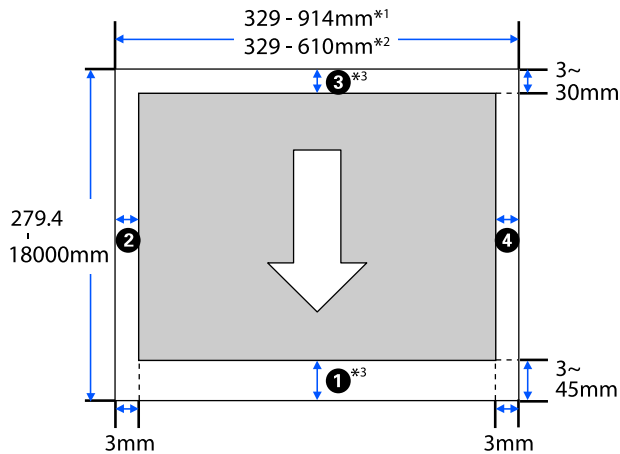

- \*1 SC-T5100 Series/SC-T5100N Series
- \*2 SC-T3100 Series/SC-T3100N Series
- \*3 In the printer driver **Layout** screen, selecting **Print Banner** sets the top and bottom margins of the paper to 0 mm.

Margins for roll paper depend on the settings values for **Top/Bottom Margins** in the menu, as shown in the table below.

**Top/Bottom Margins** settings  "Roll Paper menu" on page 109

The default setting is **Standard**.

Top/Bottom Margins Settings	Margin Values
Standard	①,③=30 mm*
	②,④=3 mm
Top 3 mm/Bottom 3 mm	①,③=3 mm
	②,④=3 mm
Top 15 mm/Bottom 15 mm	①,③=15 mm
	②,④=3 mm
Top 45 mm/Bottom 15 mm	①=45 mm
	③=15 mm
	②,④=3 mm
3 mm	①,②,③,④=3 mm
5 mm	①,②,③,④=5 mm

\* If **Standard** is selected when the following two conditions are met, then the top and bottom margins will be 3 mm.

- The paper type settings are one of the following Singleweight Matte, Coated Paper(Generic), Plain paper, Plain Paper Thin, Plain Paper Thick, Tracing Paper, Tracing Paper <LowDuty>, or Matte Film
- The printer driver print targets are one of the following CAD/Line Drawing - Black, CAD/Line Drawing - Color, CAD/Line Drawing - Bi-Level

**Appendix****! Important:**

- ❑ *Printing is distorted when the trailing edge of the roll paper comes off the core. Make sure the trailing edge does not come inside the printing area.*
- ❑ *If the print range settings width **A** is smaller than the print data width **B**, then the sections beyond the printable width **C** will not be printed.*

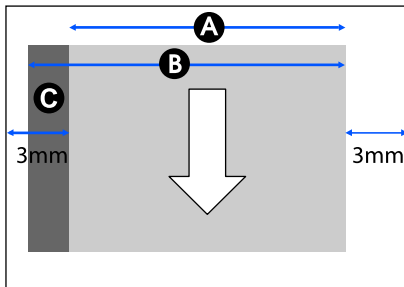

**Appendix**

**Cut Sheet (Auto Sheet Feeder)**

The gray area in the illustration below shows the printable area. The arrow in the illustration indicates the direction of the ejected paper.

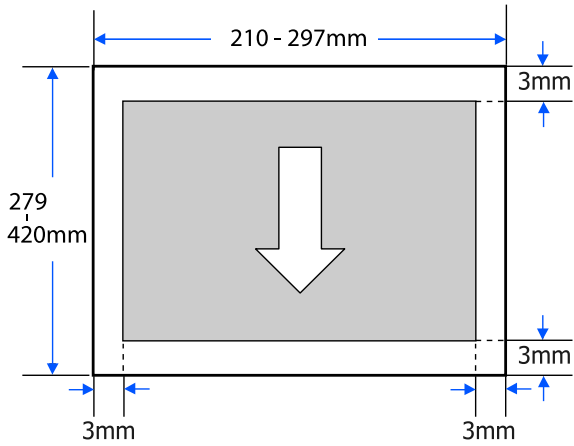

**Cut Sheet (1 Sheet)**

The gray area in the illustration below shows the printable area. The arrow in the illustration indicates the direction of the ejected paper.

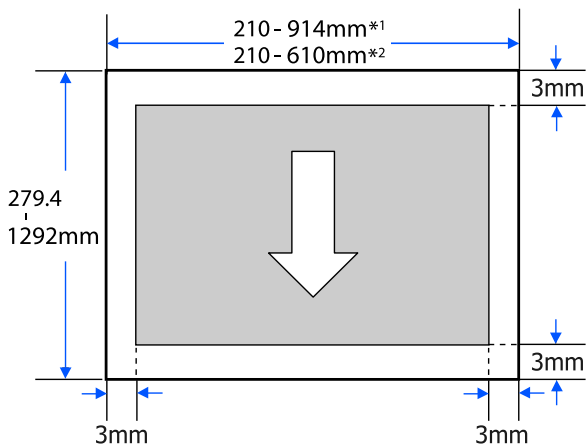

\*1 SC-T5100 Series/SC-T5100N Series

\*2 SC-T3100 Series/SC-T3100N Series

## Appendix

## Moving or Transporting the Printer

This section describes methods for moving and transporting the product.

### **Caution:**

- The printer is heavy, so ensure more than one person is used for these actions. When you pack or move the printer, use two or more people when carrying.
- When you lift the printer, maintain a natural posture.
- When you lift the printer, place your hands at the specified locations on the left and right as indicated in the following illustration. If you lift the printer while holding other sections, you may be injured. For example, you may drop the printer or your fingers may be pinched when lowering the printer.

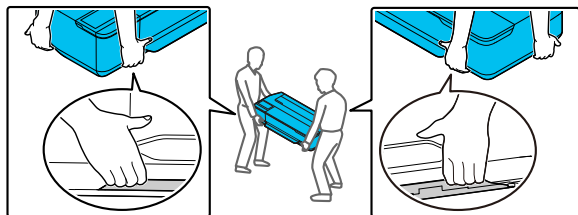

- Do not tilt the product more than 10 degrees forward or back while moving it. Failure to observe this precaution could result in the printer falling over, causing accidents.

### **Important:**

The print head may fail if the environmental temperature becomes  $-10^{\circ}\text{C}$  or lower.

Eject the ink prior to turning off the power if you expect to be moving or transporting the printer in an environment of  $-10^{\circ}\text{C}$  or below.

See the following procedure for detailed instructions.

 [“Handling if Transporting/Leaving the Printer in an Environment of  \$-10^{\circ}\text{C}\$  or Less” on page 167](#)

## Moving to a Different Location in the Same Building

### Preparations for Moving

This explains preparations for moving the printer a short distance, for example within the same building. See the following section for information on moving the printer between floors or to another building.

 [“When Transporting” on page 167](#)

For models with stands, moving the printer on casters is possible providing there are no steps or unevenness in the floor along the route, however pay attention to the following points.

### **Caution:**

For models with stands, ensure that you abide by the following points in order to prevent damage from falling over.

- Do not move the printer with casters locked
- Avoid areas with steps or unevenness
- After moving, ensure the casters are locked before use

### **Important:**

Ensure you move and transport the printer with the ink cartridges installed. Do not remove the ink cartridges; otherwise, the nozzles may be clogged and make it impossible to print, or ink may leak.

- 1** Remove all paper from the printer. If a Stacker is installed, then remove.
- 2** Close all covers on the printer. For models with stands, close the paper basket.
- 3** Turn off the printer, and unplug all cables, including the power cord and LAN cables, etc.
- 4** For models with stands, release the locks on the casters.

## Appendix

### Operations after Moving

This explains operations to prepare for use after moving the printer.

- 1 Connect the power cable, and turn the printer on.
- 2 Check for print head nozzle clogging, and if these are clogged, carry out print head cleaning.
  - ☞ “Checking for Clogged Print Head, and Cleaning” on page 134

### When Transporting

Before transporting the printer, contact your dealer or Epson Support.

☞ “Where To Get Help” on page 174

### Handling if Transporting/ Leaving the Printer in an Environment of -10°C or Less

The print head may fail if the environmental temperature becomes -10°C or lower. Discharge the ink following the procedures below if you expect the printer to encounter environments of -10°C or below.

#### **Important:**

*This procedure discharges ink into the Maintenance Box, therefore the Maintenance Box requires adequate remaining capacity. If the remaining capacity box is low, first prepare a new replacement Maintenance Box.*

- 1 If paper is loaded, remove all paper.
  - ☞ “Removing Roll Paper” on page 32
  - ☞ “Removing Cut Sheet (1 Sheet)” on page 38
- 2 From the Home screen, touch **Settings - Maintenance - Discharging/Charging Ink**.
- 3 Touch **Start**.
  - Move the ink cartridge to the replacement position.

- 4 Open the front cover.

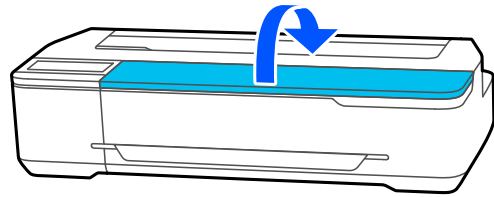

- 5 Open the cartridge cover, and remove all ink cartridges.

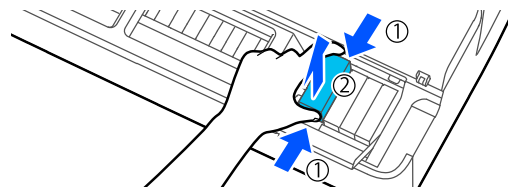

After ink discharge, reinstall the ink cartridges. Place the removed ink cartridges nearby with the ink supply port down, or laid horizontally.

- 6 Close the cartridge cover and front cover.
  - Close the front cover to start ink discharge.

#### **Important:**

*Do not open the cover or turn the printer off during ink discharge.*

- 7 If **Open the front cover and insert all the ink cartridges.** is displayed, open the front cover and cartridge cover again.

- 8 Set all ink cartridges removed in Step 5.

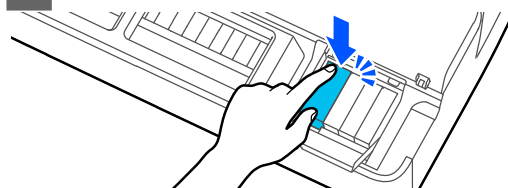

- 9 Close the cartridge cover and front cover.
  - Closing the front cover automatically turns off the power to the printer.

After this, refer to the following for preparations for movement/transport.

☞ “Moving to a Different Location in the Same Building” on page 166

☞ “When Transporting” on page 167

## Appendix

 **Important:**

*When a **You will need a new XXX ink cartridge to start using the printer again.** message is displayed, prepare an ink cartridge of the color shown with XXX by the time the printer is next used.*

*The next time the power is turned on, if the amount of ink required in order to perform ink charging (filling with ink until the print head nozzle section, readying the device for printing) is not available, then the printer will not be usable until the ink cartridge is replaced.*



## Appendix

# System Requirements

Software for this printer can be used in the following environments. (As of April, 2018)

Supported OS and other elements may change.

For the latest information, see the Epson Web site.

---

## Printer Driver

### Windows

Operating system	Windows 10 / Windows 10 x64 Windows 8.1 / Windows 8.1 x64 Windows 8 / Windows 8 x64 Windows 7 / Windows 7 x64 Windows Vista / Windows Vista x64 Windows XP / Windows XP x64 Windows Server 2016 Windows Server 2012 R2 Windows Server 2012 Windows Server 2008 R2 Windows Server 2008 Windows Server 2003 R2 Windows Server 2003 SP2 or later
CPU	Intel Core 2 Duo 3.05 GHz or more
Available memory space	1 GB or more
Hard disk (Available volume to install)	32 GB or more
Display resolution	WXGA (1280×800) or better
Connection method with the printer*	USB, Ethernet, or Wi-Fi

\*For details on the connection methods (interface specifications), see the following.

 ["Specifications Table" on page 171](#)

### Mac

Operating system	Mac OS X v10.6.8 or later
CPU	Intel Core 2 Duo 3.05 GHz or more
Available memory space	4 GB or more
Hard disk (Available volume to install)	32 GB or more
Display resolution	WXGA+ (1440×900) or better
Connection method with the printer*	USB, Ethernet, or Wi-Fi

\*For details on the connection methods (interface specifications), see the following.

 ["Specifications Table" on page 171](#)

## Appendix

### Web Config

#### Windows

Browser	Internet Explorer 11, Microsoft Edge, Firefox* <sup>1</sup> , Chrome* <sup>1</sup>
Connection method with the printer* <sup>2</sup>	Ethernet or Wi-Fi

\*1 Use the latest version.

\*2 See the following for details on the network interfaces.

 ["Specifications Table" on page 171](#)

#### Mac

Browser	Safari* <sup>1</sup> , Firefox* <sup>1</sup> , Chrome* <sup>1</sup>
Connection method with the printer* <sup>2</sup>	Ethernet or Wi-Fi

\*1 Use the latest version.

\*2 See the following for details on the network interfaces.

 ["Specifications Table" on page 171](#)

#### Smart device

Operating system	iOS* <sup>1</sup>	Android OS* <sup>1</sup>
Browser	Safari* <sup>1</sup>	Default browser
Connection method with the printer* <sup>2</sup>	Wi-Fi	Wi-Fi

\*1 Use the latest version.

\*2 See the following for details on the network interfaces.

 ["Specifications Table" on page 171](#)

Appendix

# Specifications Table

The (A) to (D) letters used in the table represent the printer models as shown below.

- (A): SC-T5100 Series
- (B): SC-T3100 Series
- (C): SC-T5100N Series
- (D): SC-T3100N Series

Printer Specifications	
Printing method	On-demand ink jet
Nozzle configuration	800 nozzles × 4 colors (Black, Cyan, Magenta, Yellow)
Resolution (maximum)	2400 × 1200 dpi
Control code	ESC/P2, ESC/P raster (undisclosed command), ESC/P3, ESC/P-R, HP-GL/2, HP RTL, PJI
Built-in memory	1.0 GB
Rated voltage	AC100-240 V
Rated frequency	50/60 Hz
Rated current	1.4 A
Power consumption	
Printing	Approx. 28 W
Ready mode	Approx. 8 W
Sleep mode	Approx. 1.6 W
Power off	Approx. 0.2 W
Temperature	
Printing	10 to 35°C (15 to 25°C is recommended)
In storage (before unpacking)	-20 to 60°C (within 120 hours at 60°C, within a month at 40°C)
In storage (after unpacking)	Ink charged: -10 to 40°C (within a month at 40°C) Ink discharged*1: -20 to 25°C (within a month at 25°C)
Humidity	

Printer Specifications	
Printing	20 to 80% (40 to 60% is recommended. Without condensation)
In storage	5 to 85% (without condensation)
Temperature and humidity range for operating (the range shown by diagonal lines is recommended)	
Dimensions (Width × Depth × Height)	
Maximum*2	(A): 1268 × 982 × 913 mm (B): 970 × 982 × 913 mm (C): 1268 × 811 × 230 mm (D): 970 × 811 × 230 mm
Storage	(A): 1268 × 696 × 913 mm (B): 970 × 696 × 913 mm (C): 1268 × 505 × 230 mm (D): 970 × 505 × 230 mm
Weight*3	(A): Approx. 46 kg (B): Approx. 38 kg (C): Approx. 33 kg (D): Approx. 27 kg

\*1 Use the **Discharging/Charging Ink** menu in the Maintenance menu to discharge ink from the printer.  
["Handling if Transporting/Leaving the Printer in an Environment of -10°C or Less" on page 167](#)

\*2 With the paper basket is opened and the paper stacker is attached

\*3 Not including the ink cartridges and the paper stacker



**Important:**

Use the printer at an altitude of 2000 m or less.

## Appendix

Interface Specifications	
USB port for a computer	SuperSpeed USB
Option port (USB port for a scanner)	Hi-Speed USB
Ethernet* <sup>1</sup> Standards	IEEE802.3i (10BASE-T) IEEE802.3u (100BASE-TX) IEEE802.3ab (1000BASE-T) IEEE802.3az (Energy Efficient Ethernet)* <sup>2</sup>
Wi-Fi	
Standards	IEEE802.11b/g/n* <sup>3</sup>
Frequency Range	2.4 GHz
Connection Modes	Infrastructure Wi-Fi Direct (Simple AP)* <sup>4</sup>
Wireless Securities	WEP (64/128bit) WPA-PSK (TKIP) WPA2-PSK (AES)* <sup>5</sup>
Network Printing Protocols/Functions* <sup>6</sup>	EpsonNet Print (Windows) Standard TCP/IP (Windows) WSD Printing (Windows) Bonjour Printing (Mac) IPP Printing (Mac) AirPrint (iOS, Mac) Printing from FTP client
Security Protocols	SSL/TLS (HTTPS Server/Client, IPPS) IEEE802.1X IPsec/IP Filtering SMTPS (STARTTLS, SSL/TLS) SNMPv3

\*1: Use a category 5 or higher STP (Shielded twisted pair) cable.

\*2: The connected device should comply with IEEE802.3az standards.

\*3: IEEE802.11n is only available for the HT20.

\*4: Not supported for IEEE 802.11b.

\*5: Complies with WPA2 standards with support for WPA/WPA2 Personal.

\*6: EpsonNet Print supports IPv4 only. The others support both IPv4 and IPv6.

**Warning:**

To prevent radio interference to the licensed service, this device is intended to be operated indoors and away from windows to provide maximum shielding. Equipment (or its transmit antenna) that is installed outdoors is subject to licensing

**Ink Specifications**

Type	Dedicated ink cartridges
Pigment ink	Black, Cyan, Magenta, Yellow
Use by date	See the expiration date printed on the ink cartridge package or on the cartridge (store at normal temperature)
Print quality guarantee expiry	Six months (after unpacking)
Storage temperature	
Uninstalled	-20 to 40°C (within four days at -20°C, within a month at 40°C)
Installed	-20 to 40°C (within four days at -20°C, within a month at 40°C)
Transporting	-20 to 60°C (within four days at -20°C, within a month at 40°C, within 72 hours at 60°C)
Cartridge Dimensions (Width × Depth × Height)	
80 ml	41.0 × 97.0 × 49.5* mm
50 ml / 26 ml	27.0 × 97.0 × 49.5* mm

\*Not including the protruding portions

**Important:**

- The ink freezes if left at below -13°C for a long time. If it does freeze, leave it at room temperature (25°C) for at least three hours.
- Do not refill the ink cartridges.

**For European users****CE Marking**

Simplified EU Declaration of Conformity:

## Appendix

Hereby, Seiko Epson Corporation declares that this equipment Model:K291A is in compliance with directive 2014/53/EU. The full text of the EU declaration of conformity is available at the following internet address.

<http://www.epson.eu/conformity>

### Radio Equipment Information

This product intentionally emit radio wave described as follows.

- (a) frequency band in which the radio equipment operates; 2.4 to 2.4835 GHz
- (b) maximum radio-frequency power transmitted in the frequency band in which the radio equipment operates;20dBm (eirp power)

## Where To Get Help

---

# Where To Get Help

---

## Technical Support Web Site

Epson's Technical Support Web Site provides help with problems that cannot be solved using the troubleshooting information in your product documentation. If you have a Web browser and can connect to the Internet, access the site at:

<http://support.epson.net/>

If you need the latest drivers, FAQs, manuals, or other downloadables, access the site at:

<http://www.epson.com>

Then, select the support section of your local Epson Web site.

## Contacting Epson Support

---

### Before Contacting Epson

If your Epson product is not operating properly and you cannot solve the problem using the troubleshooting information in your product documentation, contact Epson support services for assistance. If Epson support for your area is not listed below, contact the dealer where you purchased your product.

Epson support will be able to help you much more quickly if you give them the following information:

- Product serial number  
(The serial number label is usually on the back of the product.)
- Product model
- Product software version  
(Click **About**, **Version Info**, or similar button in the product software.)
- Brand and model of your computer
- Your computer operating system name and version
- Names and versions of the software applications you normally use with your product

## Where To Get Help

### Help for Users in North America

Epson provides the technical support services listed below.

#### Internet Support

Visit Epson's support website at <http://epson.com/support> and select your product for solutions to common problems. You can download drivers and documentation, get FAQs and troubleshooting advice, or e-mail Epson with your questions.

#### Speak to a Support Representative

Dial: (562) 276-1300 (U.S.), or (905) 709-9475 (Canada), 6 am to 6 pm, Pacific Time, Monday through Friday. Days and hours of support are subject to change without notice. Toll or long distance charges may apply.

Before you call Epson for support, please have the following information ready:

- Product name
- Product serial number
- Proof of purchase (such as a store receipt) and date of purchase
- Computer configuration
- Description of the problem

**Note:**

*For help using any other software on your system, see the documentation for that software for technical support information.*

#### Purchase Supplies and Accessories

You can purchase genuine Epson ink cartridges, ribbon cartridges, paper, and accessories from an Epson authorized reseller. To find the nearest reseller, call 800-GO-EPSON (800-463-7766). Or you can purchase online at <http://www.epsonstore.com> (U.S. sales) or <http://www.epson.ca> (Canadian sales).

### Help for Users in Europe

Check your **Pan-European Warranty Document** for information on how to contact Epson support.

### Help for Users in Australia

Epson Australia wishes to provide you with a high level of customer service. In addition to your product documentation, we provide the following sources for obtaining information:

#### Your Dealer

Don't forget that your dealer can often help identify and resolve problems. The dealer should always be the first call for advice on problems; they can often solve problems quickly and easily as well as give advice on the next step to take.

#### Internet URL

<http://www.epson.com.au>

Access the Epson Australia World Wide Web pages. Worth taking your modem here for the occasional surf! The site provides a download area for drivers, Epson contact points, new product information and technical support (e-mail).

#### Epson Helpdesk

Epson Helpdesk is provided as a final backup to make sure our clients have access to advice. Operators on the Helpdesk can aid you in installing, configuring and operating your Epson product. Our Pre-sales Helpdesk staff can provide literature on new Epson products and advise where the nearest dealer or service agent is located. Many types of queries are answered here.

The Helpdesk numbers are:

Phone: 1300 361 054

Fax: (02) 8899 3789

## Where To Get Help

We encourage you to have all the relevant information on hand when you ring. The more information you prepare, the faster we can help solve the problem. This information includes your Epson product documentation, type of computer, operating system, application programs, and any information you feel is required.

---

### Help for Users in Singapore

Sources of information, support, and services available from Epson Singapore are:

#### World Wide Web

(<http://www.epson.com.sg>)

Information on product specifications, drivers for download, Frequently Asked Questions (FAQ), Sales Enquiries, and Technical Support via e-mail are available.

#### Epson HelpDesk

(Phone: (65) 6586 3111)

Our HelpDesk team can help you with the following over the phone:

- Sales enquiries and product information
- Product usage questions or problems
- Enquiries on repair service and warranty

---

### Help for Users in Thailand

Contacts for information, support, and services are:

#### World Wide Web

(<http://www.epson.co.th>)

Information on product specifications, drivers for download, Frequently Asked Questions (FAQ), and e-mail are available.

#### Epson Hotline

(Phone: (66) 2685 -9899)

Our Hotline team can help you with the following over the phone:

- Sales enquiries and product information
- Product usage questions or problems
- Enquiries on repair service and warranty

---

### Help for Users in Vietnam

Contacts for information, support, and services are:

Epson Hotline (Phone): 84-8-823-9239

Service Center: 80 Truong Dinh Street,  
District 1, Hochiminh City  
Vietnam

---

### Help for Users in Indonesia

Contacts for information, support, and services are:

#### World Wide Web

(<http://www.epson.co.id>)

- Information on product specifications, drivers for download
- Frequently Asked Questions (FAQ), Sales Enquiries, questions through e-mail

#### Epson Hotline

- Sales enquiries and product information
- Technical support
 

Phone	(62) 21-572 4350
Fax	(62) 21-572 4357

#### Epson Service Center

Jakarta                      Mangga Dua Mall 3rd floor No 3A/B  
Jl. Arteri Mangga Dua,  
Jakarta

Phone/Fax: (62) 21-62301104



## Where To Get Help

Bandung	Lippo Center 8th floor Jl. Gatot Subroto No.2 Bandung  Phone/Fax: (62) 22-7303766
Surabaya	Hitech Mall It IIB No. 12 Jl. Kusuma Bangsa 116 – 118 Surabaya  Phone: (62) 31-5355035 Fax: (62) 31 -5477837)
Yogyakarta	Hotel Natour Garuda Jl. Malioboro No. 60 Yogyakarta  Phone: (62) 274-565478
Medan	Wisma HSBC 4th floor Jl. Diponegoro No. 11 Medan  Phone/Fax: (62) 61-4516173
Makassar	MTC Karebosi Lt. III Kav. P7-8 Jl. Ahmad Yani No.49 Makassar  Phone: (62)411-350147/411-350148

---

## Help for Users in Hong Kong

To obtain technical support as well as other after-sales services, users are welcome to contact Epson Hong Kong Limited.

### Internet Home Page

Epson Hong Kong has established a local home page in both Chinese and English on the Internet to provide users with the following information:

- Product information
- Answers to Frequently Asked Questions (FAQs)
- Latest versions of Epson product drivers

Users can access our World Wide Web home page at:

<http://www.epson.com.hk>

## Technical Support Hotline

You can also contact our technical staff at the following telephone and fax numbers:

Phone: (852) 2827-8911

Fax: (852) 2827-4383

---

## Help for Users in Malaysia

Contacts for information, support, and services are:

### World Wide Web

(<http://www.epson.com.my>)

- Information on product specifications, drivers for download
- Frequently Asked Questions (FAQ), Sales Enquiries, questions through e-mail

### Epson Trading (M) Sdn. Bhd.

Head Office.

Phone: 603-56288288

Fax: 603-56288388/399

### Epson Helpdesk

- Sales enquiries and product information (Infoline)  
Phone: 603-56288222
- Enquiries on repair services & warranty, product usage and technical support (Techline)  
Phone: 603-56288333

---

## Help for Users in India

Contacts for information, support, and services are:

## Where To Get Help

### World Wide Web

(<http://www.epson.co.in>)

Information on product specifications, drivers for download, and products enquiry are available.

### Epson India Head Office - Bangalore

Phone: 080-30515000

Fax: 30515005

### Epson India Regional Offices:

Location	Telephone number	Fax number
Mumbai	022-28261515 / 16/17	022-28257287
Delhi	011-30615000	011-30615005
Chennai	044-30277500	044-30277575
Kolkata	033-22831589 / 90	033-22831591
Hyderabad	040-66331738/ 39	040-66328633
Cochin	0484-2357950	0484-2357950
Coimbatore	0422-2380002	NA
Pune	020-30286000 / 30286001 /30286002	020-30286000
Ahmedabad	079-26407176 / 77	079-26407347

### Helpline

For Service, Product info or to order a cartridge - 18004250011 (9AM - 9PM) - This is a Toll-free number.

For Service (CDMA & Mobile Users) - 3900 1600 (9AM - 6PM) Prefix local STD code

## Help for Users in the Philippines

To obtain technical support as well as other after sales services, users are welcome to contact the Epson Philippines Corporation at the telephone and fax numbers and e-mail address below:

Trunk Line: (63-2) 706 2609

Fax: (63-2) 706 2665

Helpdesk Direct Line: (63-2) 706 2625

E-mail: [epchelpdesk@epc.epson.com.ph](mailto:epchelpdesk@epc.epson.com.ph)

### World Wide Web

(<http://www.epson.com.ph>)

Information on product specifications, drivers for download, Frequently Asked Questions (FAQ), and E-mail Enquiries are available.

**Toll-Free No. 1800-1069-EPSON(37766)**

Our Hotline team can help you with the following over the phone:

- Sales enquiries and product information
- Product usage questions or problems
- Enquiries on repair service and warranty