



Newland

SCANNING MADE SIMPLE



HR32 Marlin BT SD User Guide

Disclaimer

© 2019 Fujian Newland Auto-ID Tech. Co., Ltd. All rights reserved.

Please read through the manual carefully before using the product and operate it according to the manual. It is advised that you should keep this manual for future reference.

Do not disassemble the device or remove the seal label from the device, doing so will void the product warranty provided by Fujian Newland Auto-ID Tech. Co., Ltd.

All pictures in this manual are for reference only and actual product may differ. Regarding to the product modification and update, Fujian Newland Auto-ID Tech. Co., Ltd. reserves the right to make changes to any software or hardware to improve reliability, function, or design at any time without notice. The information contained herein is subject to change without prior notice.

The products depicted in this manual may include software copyrighted by Fujian Newland Auto-ID Tech. Co., Ltd or third party. The user, corporation or individual, shall not duplicate, in whole or in part, distribute, modify, decompile, disassemble, decode, reverse engineer, rent, transfer or sublicense such software without prior written consent from the copyright holders.

This manual is copyrighted. No part of this publication may be reproduced, distributed or used in any form without written permission from Newland.

Fujian Newland Auto-ID Tech. Co., Ltd. reserves the right to make final interpretation of the statement above.

Fujian Newland Auto-ID Tech. Co., Ltd.

No.1, Rujiang West Rd., Mawei, Fuzhou, Fujian, China 350015

<http://www.newlandaidc.com>

Revision History

Version	Description	Date
V1.0.0	Initial release.	Dec 30, 2021

Table of Contents

Revision History	3
Preface	1
Introduction	1
Chapter Description	1
Explanation of Icons	2
Chapter 1 Getting Started	3
Introduction	3
Features of the HR3280	3
Unpacking	3
The Scanner.....	4
Dimensions of the Scanner (unit: mm).....	5
SD32 Cradle.....	6
Dimensions of the Cradle (unit: mm).....	7
Connecting the Cradle to a Host	8
Chapter 2 Easyset	10
Chapter 3 System Setting	11
Introduction	11
Barcode Programming	11
Command Programming	11
EasySet Programming	11
Programming Barcode/ Programming Command/Function.....	12
Use of Programming Command.....	13
Use of Programming Barcodes	13
Illumination	14
Illumination Color	14
Aiming	15
Good Read LED.....	16
Good Read LED Duration	16
Power On Beep.....	17
Good Read Beep	17
Good Read Beep Duration.....	18
Good Read Beep Frequency	19
Good Read Beep Volume	20

Reminder Beep Volume	21
Scan Mode	23
Decode Session Timeout	24
Image Stabilization Timeout (Sense Mode).....	25
Reread Timeout	26
Image Decoding Timeout	27
Image Decoding Preference.....	28
Sensitivity (Sense Mode)	28
Scanning Preference.....	29
Read Barcode On/Off.....	29
Smart Stand Mode	30
Decode Area	30
Image Flipping.....	34
Bad Read Message.....	35
Set Bad Read Message	35
Power Off/Battery Off	36
Default Settings.....	36
Factory Defaults.....	36
Custom Defaults	37
Query Scanner Information	38
Query Product Name	38
Query Firmware Version	38
Query Decoder Version.....	38
Query Bluetooth Hardware Version	39
Query Data Formatter Version.....	39
Query Hardware Version.....	39
Query Serial Number	39
Query Manufacturing Date	40
Query OEM Serial Number	41
Query Remaining Battery of Scanner.....	42
Chapter 4 Bluetooth Dongle	43
Introduction	43
Bluetooth HID Keyboard	44
USB Country Keyboard Types	45
Emulate ALT+Keypad	49
Function Key Mapping	53
ASCII Function Key Mapping Table	54

ASCII Function Key Mapping Table (Continued)	55
Inter-Keystroke Delay.....	56
Caps Lock	57
Convert Case	58
Emulate Numeric Keypad	59
Polling Rate.....	61
Bluetooth Dongle CDC.....	63
Bluetooth Dongle HID POS (POS HID Barcode Scanner)	64
Introduction	64
Access the scanner with Your Program	64
Acquire Scanned Data	65
Send Command to the Cradle.....	65
VID/PID	66
Chapter 5 Wireless Communication	67
Default Setting of Wireless Communication	67
Operating Modes.....	68
Batch Mode.....	69
Batch Mode Options	69
Prevent Same Barcode Storage	70
Batch Mode Transmit Delay.....	71
End of Transmission Message for Batch Mode.....	72
Transmit Stored Data.....	73
Auto Clear Stored Data after Transmission.....	73
Query/Clear Stored Data in Flash	73
Retransmission	74
Auto Power-Off Timeout.....	75
Set Scanner Name	76
Set Date and Time	77
Query Current Date and Time	77
Time Stamp.....	78
Set Time Stamp Format.....	79
Chapter 6 Symbologies.....	80
Introduction	80
Global Settings.....	80
Enable/Disable All Symbologies	80
Enable/Disable 1D Symbologies.....	80
Enable/Disable 2D Symbologies.....	81

Enable/Disable Postal Symbologies	81
Surround GS1 Application Identifiers (AI's) with Parentheses	82
Transmit GS1 Check Character	83
Code 128.....	84
Restore Factory Defaults	84
Enable/Disable Code 128	84
Set Length Range for Code 128	85
EAN-8	86
Restore Factory Defaults	86
Enable/Disable EAN-8	86
Transmit Check Character	86
2-Digit Add-On Code.....	87
5-Digit Add-On Code.....	88
Add-On Code Required.....	89
Convert EAN-8 to EAN-13	89
EAN-13	90
Restore Factory Defaults	90
Enable/Disable EAN-13.....	90
Transmit Check Character	91
2-Digit Add-On Code.....	91
5-Digit Add-On Code.....	92
Add-On Code Required.....	92
EAN-13 Beginning with 290 Add-On Code Required.....	93
EAN-13 Beginning with 378/379 Add-On Code Required.....	93
EAN-13 Beginning with 414/419 Add-On Code Required.....	94
EAN-13 Beginning with 434/439 Add-On Code Required.....	94
EAN-13 Beginning with 977 Add-On Code Required.....	96
EAN-13 Beginning with 978 Add-On Code Required.....	96
EAN-13 Beginning with 979 Add-On Code Required.....	97
UPC-E.....	98
Restore Factory Defaults	98
Enable/Disable UPC-E.....	98
Transmit Check Character	99
2-Digit Add-On Code.....	99
5-Digit Add-On Code.....	100
Add-On Code Required.....	101
Transmit Preamble Character	101

Convert UPC-E to UPC-A	101
UPC-A	103
Restore Factory Defaults	103
Enable/Disable UPC-A	103
Transmit Check Character	103
2-Digit Add-On Code	104
5-Digit Add-On Code	105
Add-On Code Required	106
Transmit Preamble Character	106
Coupon	107
UPC-A/EAN-13 with Extended Coupon Code	107
Coupon GS1 Databar Output	108
Interleaved 2 of 5	109
Restore Factory Defaults	109
Enable/Disable Interleaved 2 of 5	109
Set Length Range for Interleaved 2 of 5	110
Check Character Verification	111
Febraban	112
Disable/Enable Febraban	112
Transmit Delay per Character	112
Transmit Delay per 12 Characters	115
ITF-14	117
Restore Factory Defaults	117
Enable/Disable ITF-14	117
ITF-6	118
Restore Factory Defaults	118
Enable/Disable ITF-6	118
Matrix 2 of 5	119
Restore Factory Defaults	119
Enable/Disable Matrix 2 of 5	119
Set Length Range for Matrix 2 of 5	120
Check Character Verification	121
Code 39	122
Restore Factory Defaults	122
Enable/Disable Code 39	122
Set Length Range for Code 39	123
Check Character Verification	124

Transmit Start/Stop Character	125
Enable/Disable Code 39 Full ASCII	125
Enable/Disable Code 32 (Italian Pharma Code)	126
Code 32 Prefix	126
Transmit Code 32 Start/Stop Character	127
Transmit Code 32 Check Character	127
Codabar	128
Restore Factory Defaults	128
Enable/Disable Codabar	128
Set Length Range for Codabar	129
Check Character Verification	130
Start/Stop Character	131
Code 93	132
Restore Factory Defaults	132
Enable/Disable Code 93	132
Set Length Range for Code 93	133
Check Character Verification	134
China Post 25.....	135
Restore Factory Defaults	135
Enable/Disable China Post 25	135
Set Length Range for China Post 25	136
Check Character Verification	137
GS1-128 (UCC/EAN-128)	138
Restore Factory Defaults	138
Enable/Disable GS1-128.....	138
Set Length Range for GS1-128.....	139
GS1 Databar (RSS)	140
Restore Factory Defaults	140
Enable/Disable GS1 Databar	140
Transmit Application Identifier "01"	140
GS1 Composite (EAN-UCC Composite)	141
Restore Factory Defaults	141
Enable/Disable GS1 Composite.....	141
Enable/Disable UPC/EAN Composite	141
Code 11	142
Restore Factory Defaults	142
Enable/Disable Code 11	142

Set Length Range for Code 11	143
Check Character Verification	144
Transmit Check Character	145
ISBN.....	146
Restore Factory Defaults	146
Enable/Disable ISBN.....	146
Set ISBN Format.....	147
ISSN.....	148
Restore Factory Defaults	148
Enable/Disable ISSN.....	148
Industrial 25.....	149
Restore Factory Defaults	149
Enable/Disable Industrial 25	149
Set Length Range for Industrial 25	150
Check Character Verification	151
Standard 25.....	152
Restore Factory Defaults	152
Enable/Disable Standard 25	152
Set Length Range for Standard 25	153
Check Character Verification	154
Plessey	155
Restore Factory Defaults	155
Enable/Disable Plessey	155
Set Length Range for Plessey	156
Check Character Verification	157
MSI-Plessey.....	158
Restore Factory Defaults	158
Enable/Disable MSI-Plessey.....	158
Set Length Range for MSI-Plessey.....	159
Check Character Verification	160
Transmit Check Character	161
AIM 128.....	162
Restore Factory Defaults	162
Enable/Disable AIM 128.....	162
Set Length Range for AIM 128.....	163
ISBT 128.....	164
Restore Factory Defaults	164

Enable/Disable ISBT 128	164
Code 49	165
Restore Factory Defaults	165
Enable/Disable Code 49	165
Set Length Range for Code 49	166
Code 16K	167
Restore Factory Defaults	167
Enable/Disable Code 16K	167
Set Length Range for Code 16K	168
PDF417	169
Restore Factory Defaults	169
Enable/Disable PDF417	169
Set Length Range for PDF417	170
PDF417 Twin Code	171
PDF417 Inverse	172
Character Encoding	172
PDF417 ECI Output	173
Micro PDF417	174
Restore Factory Defaults	174
Enable/Disable Micro PDF417	174
Set Length Range for Micro PDF417	175
QR Code	176
Restore Factory Defaults	176
Enable/Disable QR Code	176
Set Length Range for QR Code	177
QR Twin Code	178
QR Inverse	179
Character Encoding	179
QR ECI Output	180
Micro QR Code	181
Restore Factory Defaults	181
Enable/Disable Micro QR	181
Set Length Range for Micro QR	182
Aztec	183
Restore Factory Defaults	183
Enable/Disable Aztec Code	183
Set Length Range for Aztec Code	184

Read Multi-barcodes on an Image	185
Set the Number of Barcodes	186
Character Encoding	187
Aztec ECI Output	187
Data Matrix	188
Restore Factory Defaults	188
Enable/Disable Data Matrix.....	188
Set Length Range for Data Matrix.....	189
Data Matrix Twin Code.....	190
Rectangular Barcode	191
Data Matrix Inverse	191
Character Encoding	192
Data Matrix ECI Output.....	192
Maxicode.....	193
Restore Factory Defaults	193
Enable/Disable Maxicode.....	193
Set Length Range for Maxicode.....	194
Chinese Sensible Code.....	195
Restore Factory Defaults	195
Enable/Disable Chinese Sensible Code.....	195
Set Length Range for Chinese Sensible Code.....	196
Chinese Sensible Twin Code	197
Chinese Sensible Code Inverse.....	198
GM Code.....	199
Restore Factory Defaults	199
Enable/Disable GM	199
Set Length Range for GM	200
Code One.....	201
Restore Factory Defaults	201
Enable/Disable Code One.....	201
Set Length Range for Code One.....	202
USPS Postnet	203
Restore Factory Defaults	203
Enable/Disable USPS Postnet	203
Transmit Check Character	203
USPS Intelligent Mail	204
Restore Factory Defaults	204

Enable/Disable USPS Intelligent Mail	204
Royal Mail	205
Restore Factory Defaults	205
Enable/Disable Royal Mail	205
USPS Planet	206
Restore Factory Defaults	206
Enable/Disable USPS Planet	206
Transmit Check Character	206
KIX Post	207
Restore Factory Defaults	207
Enable/Disable KIX Post	207
Australian Postal	208
Restore Factory Defaults	208
Enable/Disable Australian Postal	208
Passport OCR	209
Restore Factory Defaults	209
Enable/Disable Passport OCR	209
Chapter 7 Data Formatter	210
Introduction	210
Add a Data Format	210
Programming with Barcodes	210
Programming with Serial Commands	213
Enable/Disable Data Formatter	214
Non-Match Error Beep	215
Data Format Selection	216
Change Data Format for a Single Scan	217
Clear Data Format	218
Query Data Formats	218
Formatter Command Type 6	219
Send Commands	219
Move Commands	223
Search Commands	225
Comparison Command	228
Miscellaneous Commands	230
Chapter 8 Prefix&Suffix	236
Introduction	236
Global Settings	237

Enable/Disable All Prefixes/Suffixes	237
Prefix Sequence.....	237
Custom Prefix.....	238
Enable/Disable Custom Prefix	238
Set Custom Prefix	238
AIM ID Prefix.....	239
Code ID Prefix.....	240
Restore All Default Code IDs	240
Modify Code ID	240
Custom Suffix.....	252
Enable/Disable Custom Suffix.....	252
Set Custom Suffix	252
Data Packing.....	253
Introduction	253
Data Packing Options	253
Terminating Character Suffix.....	255
Enable/Disable Terminating Character Suffix.....	255
Set Terminating Character Suffix	255
Chapter 9 Batch Programming.....	257
Introduction	257
Create a Batch Command.....	258
Create a Batch Barcode.....	258
Use Batch Barcode	259
Appendix.....	260
Digit Barcodes.....	260
Save/Cancel Barcodes.....	263
Factory Defaults Table	264
AIM ID Table	273
Code ID Table.....	275
Symbology ID Number	277
ASCII Table.....	279
Unicode Key Maps	283

Preface

Introduction

This manual provides detailed instructions for setting up and using the NLS-HR3280-BT-SD wireless 2D barcode scanner (hereinafter referred to as “**the HR3280**” or “**the scanner**”).

Chapter Description

<i>Chapter 1 Getting Started</i>	: Gives a general description of HR3280 scanner
<i>Chapter 2 EasySet</i>	: Introduces a useful tool you can use to set up HR3280 scanner and develop new applications.
<i>Chapter 3 System Settings</i>	: Introduces three configuration methods and describes how to configure general parameters of HR3280 scanner.
<i>Chapter 4 Bluetooth Dongle</i>	: Describes how to configure Bluetooth Dongle communication parameters.
<i>Chapter 5 Wireless Communications</i>	: Describes how to configure the parameters necessary for wireless communication between the scanner, cradle and host device.
<i>Chapter 6 Symbologies</i>	: Lists all compatible symbologies and describes how to configure the relevant parameters.
<i>Chapter 7 Data Formatter</i>	: Explains how to customize scanned data with the data formatter.
<i>Chapter 8 Prefix & Suffix</i>	: Describes how to use prefix and suffix to customize scanned data.
<i>Chapter 9 Batch Programming</i>	: Explains how to integrate a complex programming task into a single barcode.
<i>Appendix</i>	: Provides factory defaults table and a bunch of frequently used programming barcodes.

Explanation of Icons



This icon indicates something relevant to this manual.



This icon indicates this information requires extra attention from the reader.



This icon indicates handy tips that can help you use or configure the scanner with ease.



This icon indicates practical examples that can help you to acquaint yourself with opera

Chapter 1 Getting Started

Introduction

The HR3280 wireless 2D barcode scanner reads a 1D or 2D barcode by capturing its image. Adopting the advanced **UIMG** technology independently developed by Newland Auto-ID Tech, it provides five scan modes, including Level mode, Sense mode, Continuous mode, Pulse mode and Batch mode, tailored to different scanning needs.

An illustrated introduction to the HR3280 is included in this chapter. If you have an HR3280 scanner at hand, make good use of it to develop a better understanding of this manual. This chapter is written for normal users, maintenance staff and software developers.

Features of the HR3280

- ★ More reliable, more versatile, more efficient scanning solution
- ★ Bluetooth 5.0 radio
- ★ User-friendly illumination & aiming
- ★ Ultra-rugged construction
- ★ Flexible mounting of cradle

Unpacking

Open the package and take out HR3280 scanner and its accessories. Check to make sure everything on the packing list is present and intact. If any contents are damaged or missing, please keep the original package and contact your dealer immediately for after-sales service.

The Scanner

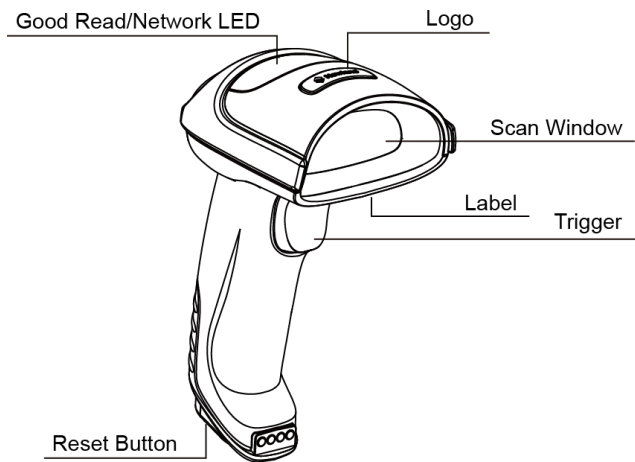

Good Read/Network LED:

Red LED flashes - Low battery alert.

Red LED on - Charging.

Blue LED flashes slowly – wireless communication disconnected.

Blue LED on - wireless communication connected.

Blue LED flashes quickly - Batch transmission in progress.

Green LED on – Full battery.

Green LED flashes once - Good read.

Dimensions of the Scanner (unit: mm)

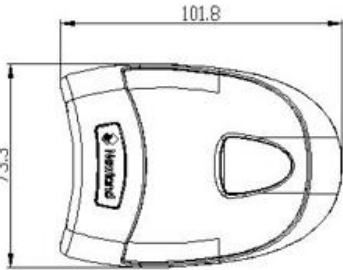
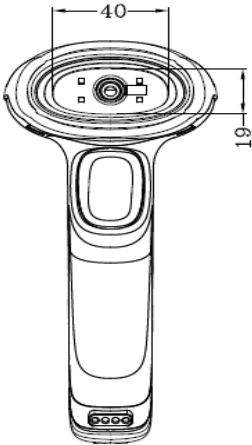
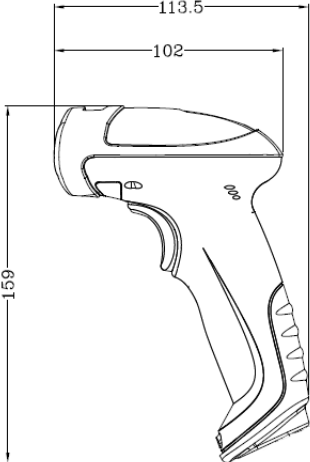

SD32 Cradle

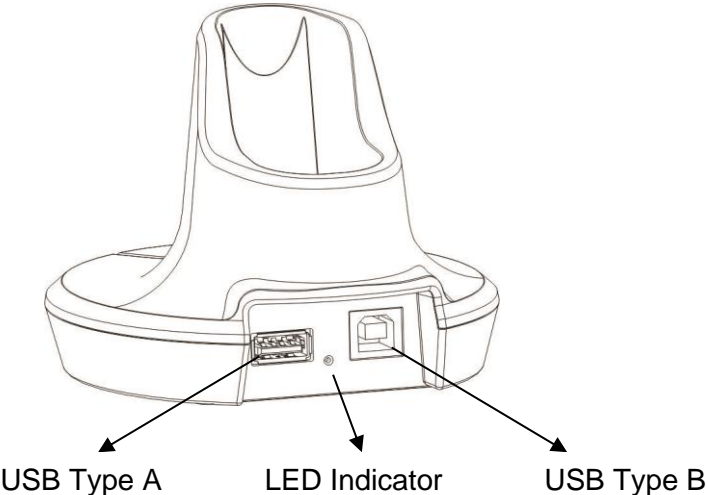

USB Type A: for Bluetooth dongle
USB Type B: connect to the host device and charging

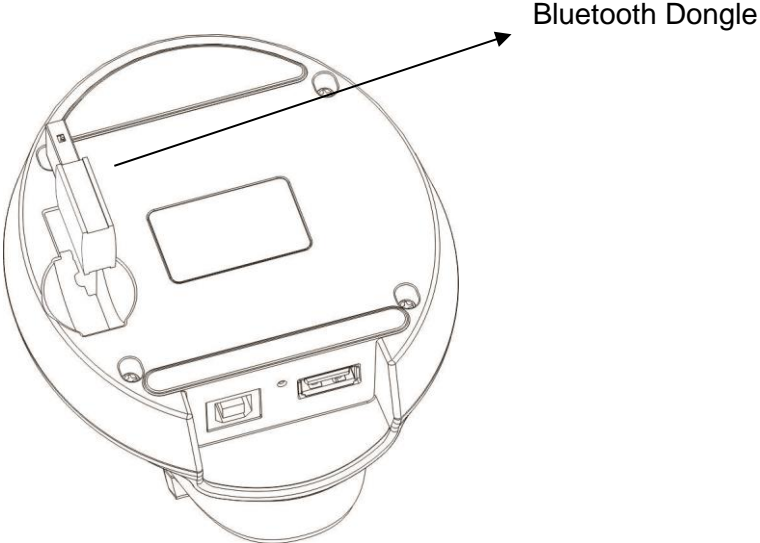

Dimensions of the Cradle (unit: mm)

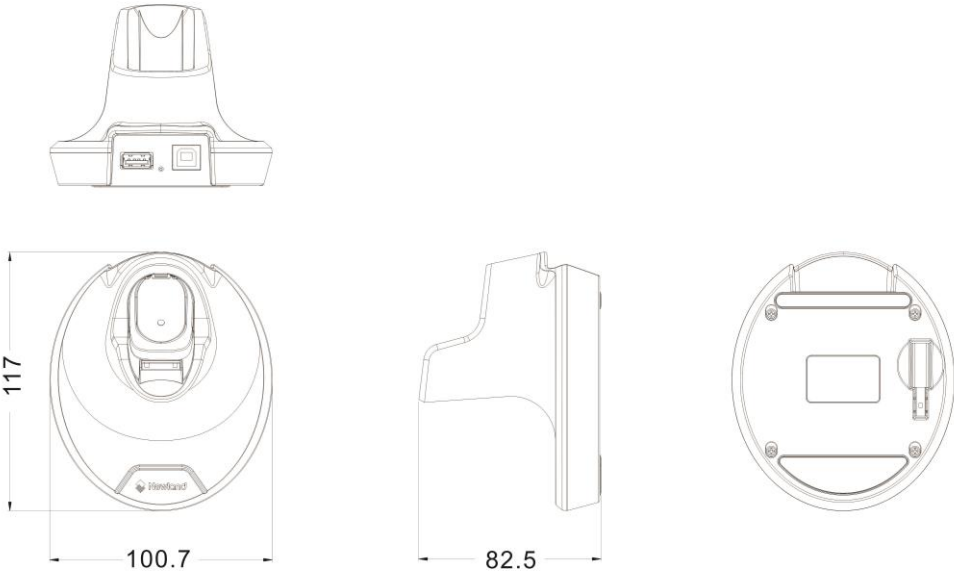

Connecting the Cradle to a Host

The cradle can be connected to a host in actual application, such as PC, POS or any intelligent terminal with Type B port, using a communication cable (Type B cable).

Scanning Instructions

When the scanner is in the Level scan mode, you can follow the steps below to scan a barcode:

1. Press and hold the Trigger. Then the scanner will project a red aiming pattern.
2. Aim the aiming pattern across the center of barcode.
3. Release the Trigger when the aiming pattern goes off. If the barcode is decoded successfully, the scanner will emit a good read beep and the decoded data will be sent to the Host.

Note: For barcodes of the same batch, the scanner keeps a very high success ratio in certain distance which is regarded as the optimal scanning distance.

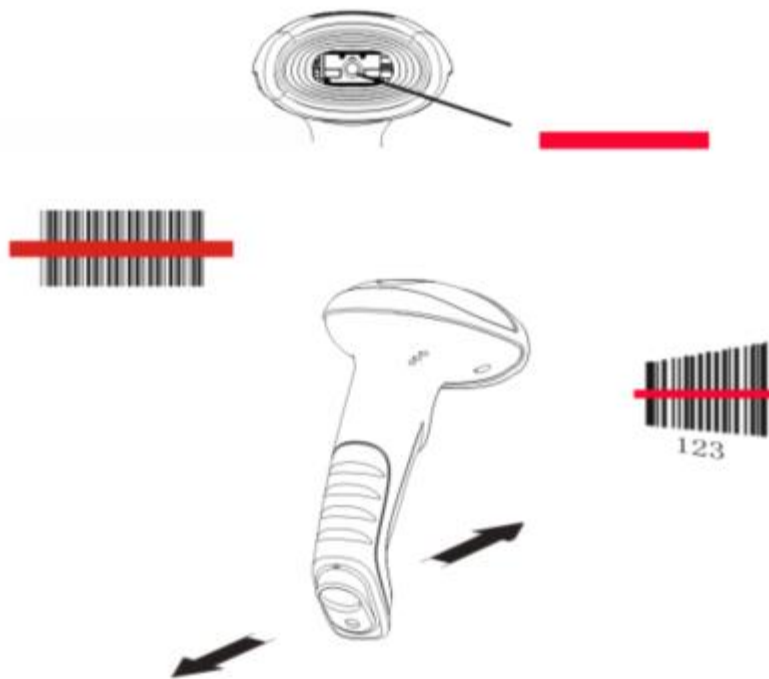

Chapter 2 Easyset

EasySet, developed by Fujian Newland Auto-ID Tech. Co., Ltd., is a configuration tool for Newland's 1D/2D handheld barcode scanner, fixed mount barcode scanners and OEM scan engines. Its main features include:

- ✧ View device & configuration information of online device
- ✧ Configure device
- ✧ Update firmware of online device
- ✧ Load/modify existing XML configuration file; save current settings to an XML file
- ✧ Create/print/save programming barcodes to a PDF or Word file
- ✧ View/edit/save image stored on online device in the original image/BMP/JPG/TIFF format
- ✧ Send serial commands to online device and receive device response
- ✧ Supported languages: Chinese and English.

EasySet supports 32-bit/64-bit Microsoft WinXP/Win7/Win 8/Win 8.1/Win 10 operating systems.

EasySet can communicate with device via one of the following interface: RS-232, USB COM Port Emulation (UFCOM driver required), USB CDC (UFCOM driver required), USB DataPipe (UFCOM driver required), USB HID-POS.

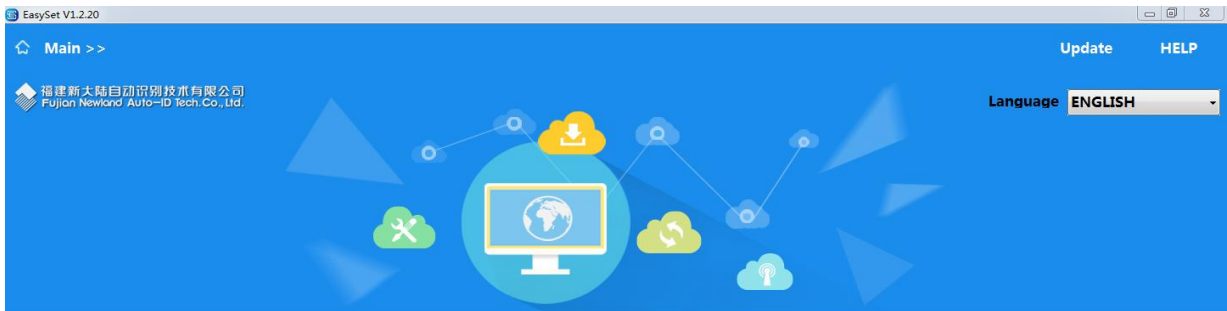



@SETUPE1

Enter Setup

Chapter 3 System Setting

Introduction

There are three ways to configure the HR3280: Barcode programming, command programming and Easyset programming.

Barcode Programming

The HR3280 can be configured by scanning programming barcodes. All user programmable features/options are described along with their programming barcodes/commands in the following sections.

This programming method is most straightforward. However, it requires manually scanning barcodes. As a result, errors are more likely to occur.

Command Programming

The HR3280 can also be configured by serial commands (HEX) sent from the host device.

Users can design an application program to send those command strings to the scanners to perform device configuration.

EasySet Programming

Besides the two methods mentioned above, you can conveniently perform scanner configuration through EasySet too. EasySet is a Windows-based configuration tool particularly designed for Newland products, enabling users to gain access to decoded data and captured images and to configure scanners. For more information about this tool, refer to the *EasySet User Guide*.



Before programming the scanner, you need to pair it to a cradle first. When programming the scanner with serial commands or EasySet, you need to insert it in the paired cradle.

Except some temporary setting will be disappeared after reboot and power off, other setting information will be stored in the scanner.



@SETUPE1

Enter Setup

Programming Barcode/ Programming Command/Function



The figure above is an example that shows you the programming barcode and command for the Enter Setup function:

1. The **No Case Conversion** barcode.
2. The **No Case Conversion** command.
3. The description of feature/option.
4. ** indicates factory default settings.

Note: "@" included in the programming command indicates permanent setting which means the setting will not be lost by removing power from the scanner or turning off or rebooting it; whereas "#" included in the programming command indicates temporary setting which means the setting will be lost by removing power from the scanner or turning off or rebooting it.



@SETUPE0

** Exit Setup



@SETUPE1
Enter Setup

Use of Programming Command

Besides the barcode programming method, the scanner can also be configured by serial commands (HEX) sent from the host device. **All commands must be entered in uppercase letters.**

Use of Programming Barcodes

Scanning the **Enter Setup** barcode can enable the scanner to enter the setup mode. Then you can scan a number of programming barcodes to configure your scanner. To exit the setup mode, scan the **Exit Setup** barcode or a non-programming barcode, or reboot the scanner.



@SETUPE0
**** Exit Setup**



@SETUPE1
Enter Setup

Programming barcode data (i.e. the characters under programming barcode) can be transmitted to the host device. You may scan the appropriate barcode below to enable or disable the transmission of programming barcode data to the host device.



#SETUPT0
**** Do Not Transmit Programming Barcode Data**



#SETUPT1
Transmit Programming Barcode Data



@SETUPE0
**** Exit Setup**



@SETUPE1
Enter Setup

Illumination



@ILLSCN1
**** On**

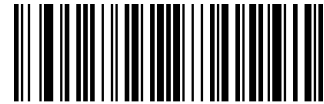

@ILLSCN0
Off

Illumination Color



@ILLCLR0
**** Red LED**



@ILLCLR1
White Led



@ILLCLR2
Red LED+White LED



@SETUPE0
**** Exit Setup**



@SETUPE1
Enter Setup

Aiming

When scanning/capturing image, the scanner projects an aiming pattern which allows positioning the target barcode within its field of view and thus makes decoding easier. **Normal:** The scanner projects an aiming pattern only during barcode scanning/capture.

Always On: Aiming pattern is constantly on after the scanner is powered on.

Off: Aiming pattern is off all the time.



@AMLENA1
** Normal



@AMLENA0
Off



@AMLENA2
Always On



@SETUPE0
** Exit Setup



@SETUPE1
Enter Setup

Good Read LED

The green LED can be programmed to be On or Off to indicate good read.



@GRLENA1
**** On**



@GRLENA0
Off

Good Read LED Duration

This parameter sets the amount of time the Good Read LED remains on following a good read.



@GRLDUR20
**** Short (20ms)**



@GRLDUR120
Medium (120ms)



@GRLDUR220
Long (220ms)



@GRLDUR320
Prolonged (320ms)



@GRLDUR
Custom (1 - 2,500ms)



@SETUPE0
**** Exit Setup**



@SETUPE1
Enter Setup

Example

Set the Good Read LED duration to 800ms:

1. Scan the **Enter Setup** barcode.
2. Scan the **Custom** barcode.
3. Scan the numeric barcodes “8”, “0” and “0” from the “Digit Barcodes” section in Appendix.
4. Scan the **Save** barcode from the “Save/Cancel Barcodes” section in Appendix.
5. Scan the **Exit Setup** barcode.

Power On Beep

The scanner can be programmed to beep when it is powered on. Scan the **Off** barcode if you do not want a power on beep.



@PWBENA1
** On



@PWBENA0
Off

Good Read Beep

Scanning the **Off** barcode can turn off the beep that indicates successful decode; scanning the **On** barcode can turn it back on.



@GRBENA1
** On



@GRBENA0
Off



@SETUPE0
** Exit Setup



@SETUPE1

Enter Setup

Good Read Beep Duration

This parameter sets the length of the beep the scanner emits on a good read. It is programmable in 1ms increments from 20ms to 300ms.



@GRBDUR40

Short (40ms)



@GRBDUR80

**** Medium (80ms)**



@GRBDUR120

Long (120ms)



@GRBDUR

Custom (20 – 300ms)

E
example

Set the Good Read Beep duration to 200ms:

1. Scan the **Enter Setup** barcode.
2. Scan the **Custom** barcode.
3. Scan the numeric barcodes “2”, “0” and “0” from the “Digit Barcodes” section in Appendix.
4. Scan the **Save** barcode from the “Save/Cancel Barcodes” section in Appendix.
5. Scan the **Exit Setup** barcode.



@SETUPE0

**** Exit Setup**



@SETUPE1
Enter Setup

Good Read Beep Frequency

This parameter is programmable in 1Hz increments from 20Hz to 20,000Hz.



@GRBFRQ800
Extra Low (800Hz)



@GRBFRQ1600
Low (1600Hz)



@GRBFRQ2730
** Medium (2730Hz)



@GRBFRQ4200
High (4200Hz)



@GRBFRQ
Custom (20 - 20,000Hz)

E
sample

Set the Good Read Beep frequency to 2,000Hz:

1. Scan the **Enter Setup** barcode.
2. Scan the **Custom** barcode.
3. Scan the numeric barcodes “2”, “0”, “0” and “0” from the “Digit Barcodes” section in Appendix.
4. Scan the **Save** barcode from the “Save/Cancel Barcodes” section in Appendix.
5. Scan the **Exit Setup** barcode.



@SETUPE0
** Exit Setup



@SETUPE1

Enter Setup

Good Read Beep Volume



@GRBVOL0

**** Loud**



@GRBVOL2

Low



@GRBVOL1

Medium



@GRBVLL

Custom (1-20)

E
example

Set the Good Read Beep Volume to 20

1. Scan the **Enter Setup** barcode.
2. Scan the **Custom** barcode.
3. Scan the numeric barcodes “2”, “0” from the “Digit Barcodes” section in Appendix.
4. Scan the **Save** barcode from the “Save/Cancel Barcodes” section in Appendix.
5. Scan the **Exit Setup** barcode.



@SETUPE0

**** Exit Setup**



@SETUPE1
Enter Setup

Reminder Beep Volume

This parameter is available for reminder beep volume of the following operations: power on (for all products), power off, batch transmission, pairing the scanner to a cradle, searching paired scanner, the scanner connects on the cradle, the scanner disconnects the cradle, bluetooth connection and transmission.



@SUCVLL20
** Loud

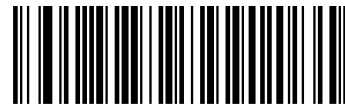

@SUCVLL12
Medium

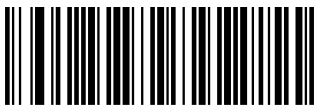

@SUCVLL5
Low



@SUCVLL0
Mute



@SUCVLL
Custom (0-20)

E
sample

Set the above operations' beep volume to 10:

1. Scan the **Enter Setup** barcode.
2. Scan the **Beep Volume** barcode.
3. Scan the numeric barcodes "1", "0" and "0" from the "Digit Barcodes" section in Appendix.
4. Scan the **Save** barcode from the "Save/Cancel Barcodes" section in Appendix.
5. Scan the **Exit Setup** barcode.



@SETUPE0
** Exit Setup



@SETUPE1

Enter Setup

This parameter is available for setting beep volume of the following operations: beep on unknown (USB KBW), failed to batch transmission, failed to search paired scanner, bluetooth disconnection and bluetooth transmission failure.



@ALMVLL20

**** Loud**



@ALMVLL12

Medium



@ALMVLL5

Low

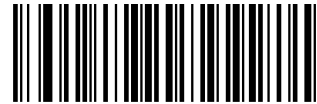

@ALMVLL0

Mute



@ALMVLL

Cutomer(0-20)

E
sample

Set the above operations' beep volume to 10:

1. Scan the **Enter Setup** barcode.
2. Scan the **Beep Volume** barcode.
3. Scan the numeric barcodes "1", "0" and "0" from the "Digit Barcodes" section in Appendix.
4. Scan the **Save** barcode from the "Save/Cancel Barcodes" section in Appendix.
5. Scan the **Exit Setup** barcode.



@SETUPE0

**** Exit Setup**



@SETUPE1
Enter Setup

Scan Mode

Level Mode: A trigger pull activates a decode session. The decode session continues until a barcode is decoded or you release the trigger.

Sense Mode: The scanner activates a decode session every time it detects a barcode presented to it. The decode session continues until a barcode is decoded or the decode session timeout expires. **Reread Timeout** can avoid undesired rereading of same barcode in a given period of time. **Sensitivity** can change the Sense Mode's sensibility to changes in images captured. **Image Stabilization Timeout** gives the scanner time to adapt to ambient environment after it decodes a barcode and "looks" for another.

Continuous Mode: The scanner automatically starts one decode session after another. To suspend/resume barcode reading, simply press the trigger. **Reread Timeout** can avoid undesired rereading of same barcode in a given period of time.

Pulse Mode: When the trigger is pulled and released, scanning is activated until a barcode is decoded or the decode session timeout expires (The decode session timeout begins when the trigger is released).

Batch Mode: A trigger pull activates a round of multiple decode sessions. This round of multiple scans continues until you release the trigger. Rereading the same barcode is not allowed in the same round.



@SCNMOD0

** Level Mode



@SCNMOD2

Sense Mode



@SCNMOD3

Continuous Mode



@SCNMOD7

Batch Mode



@SCNMOD4

Pulse Mode



@SETUPE0
** Exit Setup



@SETUPE1

Enter Setup

Decode Session Timeout

This parameter sets the maximum time decode session continues during a scan attempt. It is programmable in 1ms increments from 100ms to 3,600,000ms. When it is set to 0, the timeout is infinite. The default setting is 3,000ms.



@ORTSET

Decode Session Timeout

E
Example

Set the decode session timeout to 1,500ms:

1. Scan the **Enter Setup** barcode.
2. Scan the **Decode Session Timeout** barcode.
3. Scan the numeric barcodes “1”, “5”, “0” and “0” from the “Digit Barcodes” section in Appendix.
4. Scan the **Save** barcode from the “Save/Cancel Barcodes” section in Appendix.
5. Scan the **Exit Setup** barcode.



@SETUPE0

**** Exit Setup**



@SETUPE1

Enter Setup

Image Stabilization Timeout (Sense Mode)

This parameter defines the amount of time the scanner will spend adapting to ambient environment after it decodes a barcode and “looks” for another. It is programmable in 1ms increments from 0ms to 3,000ms. The default setting is 200ms.



@SENIST

Image Stabilization Timeout

E
xample

Set the image stabilization timeout to 800ms:

6. Scan the **Enter Setup** barcode.
7. Scan the **Image Stabilization Timeout** barcode.
8. Scan the numeric barcodes “8”, “0” and “0” from the “Digit Barcodes” section in Appendix.
9. Scan the **Save** barcode from the “Save/Cancel Barcodes” section in Appendix.
10. Scan the **Exit Setup** barcode.



@SETUPE0

** Exit Setup



@SETUPE1

Enter Setup

Reread Timeout

Reread Timeout can avoid undesired rereading of same barcode in a given period of time. This feature is only applicable to the Sense and Continuous modes.

Enable Reread Timeout: Do not allow the scanner to reread same barcode before the reread timeout expires.

Disable Reread Timeout: Allow the scanner to reread same barcode.



@RRDENA1

Enable Reread Timeout



@RRDENA0

**** Disable Reread Timeout**

The following parameter sets the time interval between two successive reads on same barcode. It is programmable in 1ms increments from 0ms to 3,600,000ms. When it is set to a value greater than 3,000, the timeout for rereading same programming barcode is limited to 3,000ms. The default setting is 1,500ms.



@RRDDUR

Set Reread Timeout

E
example

Set the reread timeout to 1,000ms:

1. Scan the **Enter Setup** barcode.
2. Scan the **Set Reread Timeout** barcode.
3. Scan the numeric barcodes "1", "0", "0" and "0" from the "Digit Barcodes" section in Appendix.
4. Scan the **Save** barcode from the "Save/Cancel Barcodes" section in Appendix.
5. Scan the **Exit Setup** barcode.



@SETUPE0

**** Exit Setup**



@SETUPE1
Enter Setup

You may wish to restart the reread timeout when the scanner encounters the same barcode that was decoded in the last scan session before the reread timeout expires. To enable this feature, scan the **Reread Timeout Reset On** barcode. This feature is only effective when **Reread Timeout** is enabled.



@RRDREN1
Reread Timeout Reset On



@RRDRENO
**** Reread Timeout Reset Off**

Image Decoding Timeout

Image Decoding Timeout specifies the maximum time the scanner will spend decoding an image. This parameter is programmable in 1ms increments from 1ms to 3,000ms. The default timeout is 500ms.



@DETSET
Image Decoding Timeout

E
sample

Set the image decoding timeout to 1,000ms:

1. Scan the **Enter Setup** barcode.
2. Scan the **Image Decoding Timeout** barcode.
3. Scan the numeric barcodes “1”, “0”, “0” and “0” from the “Digit Barcodes” section in Appendix.
4. Scan the **Save** barcode from the “Save/Cancel Barcodes” section in Appendix.
5. Scan the **Exit Setup** barcode.



@SETUPE0
**** Exit Setup**



@SETUPE1

Enter Setup

Image Decoding Preference

When the scanner is set as **Barcodes on Screen**, decoding rate reduces obviously.



@DETPFN1

Screen Barcodes



@DETPFN0

** Paper Barcodes

Sensitivity (Sense Mode)

This specifies the degree of acuteness of the scanner's response to changes in images captured. There are 20 levels to choose from. The smaller the value, the higher the sensitivity and the lower requirement in image change to trigger the scanner. You can select an appropriate degree of sensitivity that fits your application environment. This feature is only applicable to the Sense mode.



@SENLVL14

Low Sensitivity



@SENLVL11

** Medium Sensitivity



@SENLVL8

High Sensitivity



@SENLVL5

Enhanced Sensitivity



@SENLVL

Custom Sensitivity (Level 1-20)-



@SETUPE0

** Exit Setup



@SETUPE1
Enter Setup

E
sample

Set the sensitivity to Level 10:

1. Scan the **Enter Setup** barcode.
2. Scan the **Custom Sensitivity** barcode.
3. Scan the numeric barcodes “1” and “0” from the “Digit Barcodes” section in Appendix.
4. Scan the **Save** barcode from the “Save/Cancel Barcodes” section in Appendix.
5. Scan the **Exit Setup** barcode.

Scanning Preference

Normal Mode: Select this mode when reading barcodes on paper.

Screen Mode: Select this mode when reading barcodes on the screen.



@EXPLVL0
**** Normal Mode**



@EXPLVL2
Screen Mode

Read Barcode On/Off

Sending the Read Barcode Off command `~<SOH>0000#SCNENA0;<ETX>` to the scanner can disable it from reading barcode, and the scanner is unable to scan barcode unless you send the Read Barcode On command `~<SOH>0000#SCNENA1;<ETX>` to it or power cycle it. By default, Read Barcode is On.



@SETUPE0
**** Exit Setup**



@SETUPE1

Enter Setup

Smart Stand Mode

After this feature is turned on, the scanner will switch from its current scan mode to the Sense mode when it is inserted in the stand, and it will operate in its previous scan mode when it is removed from the stand.



@SMTENA0

Off



@SMTENA1

** On

Decode Area

Whole Area Decoding: The scanner attempts to decode barcode(s) within its field of view, from the center to the periphery, and transmits the barcode that has been first decoded.

Specific Area Decoding: The scanner attempts to read barcode(s) within a specified decoding area and transmits the barcode that has been first decoded. This option allows the scanner to narrow its field of view to make sure it reads only those barcodes intended by the user. For instance, if multiple barcodes are placed closely together, specific area decoding in conjunction with appropriate pre-defined decoding area will insure that only the desired barcode is read.

Acuscan: The scanner only decodes the barcode aimed squarely by the aiming pattern. For those using a crosshair aiming pattern, only the barcode aimed by the center of crosshair will be decoded.



@CADENA0

** Whole Area Decoding



@CADENA1

Specific Area Decoding



@CADENA2

Acuscan



@SETUPE0

** Exit Setup



@SETUPE1
Enter Setup

If **Specific Area Decoding** is enabled, the scanner only reads barcodes that intersect the predefined decoding area.

The default decoding area is an area of 40% top, 60% bottom, 40% left and 60% right of the scanner's field of view

You can define the decoding area using the **Top of Decoding Area**, **Bottom of Decoding Area**, **Left of Decoding Area** and **Right of Decoding Area** barcodes as well as numeric barcode(s) that represent(s) a desired percentage (0-100). The value of Bottom must be greater than that of Top; the value of Right must be greater than that of Left.



@CADTOP

Top of Decoding Area



@CADBOT

Bottom of Decoding Area



@CADLEF

Left of Decoding Area



@CADRIG

Right of Decoding Area



@SETUPE0
**** Exit Setup**



@SETUPE1

Enter Setup

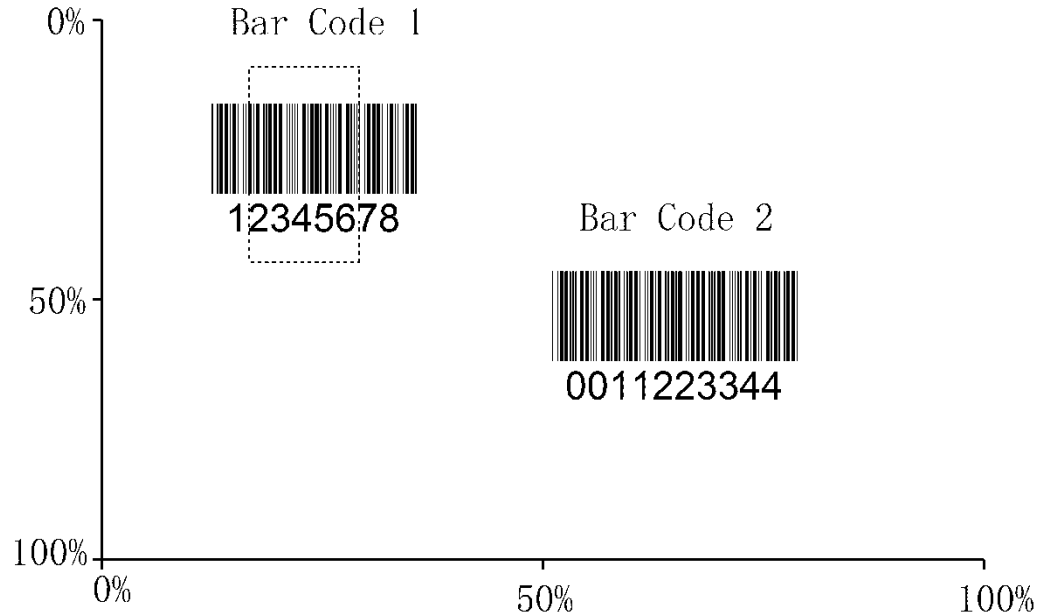

Example

Program the scanner to only read Barcode 1 in the figure above by setting the decoding area to 10% top, 45% bottom, 15% left and 30% right:

1. Scan the **Enter Setup** barcode.
2. Scan the **Top of Decoding Area** barcode.
3. Scan the numeric barcode "0" from the "Digit Barcodes" section in Appendix.
4. Scan the **Save** barcode from the "Save/Cancel Barcodes" section in Appendix.
5. Scan the **Bottom of Decoding Area** barcode.
6. Scan the numeric barcodes "4" and "5" from the "Digit Barcodes" section in Appendix.
7. Scan the **Save** barcode from the "Save/Cancel Barcodes" section in Appendix.
8. Scan the **Top of Decoding Area** barcode.
9. Scan the numeric barcodes "1" and "0" from the "Digit Barcodes" section in Appendix.
10. Scan the **Save** barcode from the "Save/Cancel Barcodes" section in Appendix.
11. Scan the **Left of Decoding Area** barcode.
12. Scan the numeric barcode "0" from the "Digit Barcodes" section in Appendix.
13. Scan the **Save** barcode from the "Save/Cancel Barcodes" section in Appendix.
14. Scan the **Right of Decoding Area** barcode.
15. Scan the numeric barcodes "3" and "0" from the "Digit Barcodes" section in Appendix.
16. Scan the **Save** barcode from the "Save/Cancel Barcodes" section in Appendix.



@SETUPE0

** Exit Setup



@SETUPE1
Enter Setup

17. Scan the **Left of Decoding Area** barcode.
18. Scan the numeric barcodes “1” and “5” from the “Digit Barcodes” section in Appendix.
19. Scan the **Save** barcode from the “Save/Cancel Barcodes” section in Appendix.
20. Scan the **Exit Setup** barcode.



@SETUPE0
** Exit Setup



@SETUPE1

Enter Setup

Image Flipping



@MIRROR0

** Do Not Flip



@MIRROR2

Flip Vertically



@MIRROR1

Flip Horizontally



@MIRROR3

Flip Horizontally & Vertically

Example of image not flipped



Example of image flipped horizontally



Example of image flipped vertically



Example of image flipped horizontally & vertically



@SETUPE0

** Exit Setup



@SETUPE1
Enter Setup

Bad Read Message

You may scan the appropriate barcode below to select whether or not to send a bad read message (user-programmable) when a good read does not occur before trigger release, or the decode session timeout expires.



@NGRENA0
**** Bad Read Message OFF**



@NGRENA1
Bad Read Message ON

Set Bad Read Message

A bad read message can contain up to 7 characters (HEX values from 0x00 to 0xFF). To set a bad read message, scan the **Set Bad Read Message** barcode, the numeric barcodes representing the hexadecimal values of desired character(s) and the **Save** barcode. The default setting is “NG”.



@NGRSET
Set Bad Read Message

E
xample

Set the bad read message to “F” (HEX: 0x46):

1. Scan the **Enter Setup** barcode.
2. Scan the **Set Bad Read Message** barcode.
3. Scan the numeric barcodes “4” and “6” from the “Digit Barcodes” section in Appendix.
4. Scan the **Save** barcode from the “Save/Cancel Barcodes” section in Appendix.
5. Scan the **Exit Setup** barcode.



@SETUPE0
**** Exit Setup**



@SETUPE1

Enter Setup

Power Off/Battery Off



@PWROFF

Power Off Scanner



@TESTMD3

Battery Off

(For Long-term Storage/Shipping)

Note: After scanning the **Battery Off** barcode, you **MUST** insert the scanner in a powered cradle to exit battery protection mode before turning it on.

Default Settings

Factory Defaults

Scanning the **Reset Scanner** barcode can restore the scanner to the factory defaults. You may need to reset your scanner when:

1. Scanner/cradle is not properly configured so that the scanner fails to decode barcodes or to communicate with the cradle.
2. you forget previous configuration and want to avoid its impact.
3. functions that are rarely used have been enabled for the time being.



@FACDEF

Reset Scanner



@SETUPE0

**** Exit Setup**



@SETUPE1
Enter Setup

Custom Defaults

Scanning the **Restore All Custom Defaults** barcode can reset all parameters on the scanner to the custom defaults.

Scanning the **Save as Custom Defaults** barcode can set the current settings as custom defaults.

Custom defaults are stored in the non-volatile memory.



@CUSSAV

Save as Custom Defaults



@CUSDEF

Restore All Custom Defaults



Restoring the scanner to the factory defaults will not remove the custom defaults from the scanner.



@SETUPE0
** Exit Setup



@SETUPE1

Enter Setup

Query Scanner Information

After scanning the barcode below, the scanner information (including product name, firmware version, decoder version, hardware version, product serial number, OEM serial number and manufacturing date) will be sent to the host device.



@QRYSYS

Query Scanner Information

Query Product Name



@QRYPDN

Query Product Name

Query Firmware Version



@QRYFWV

Query Firmware Version

Query Decoder Version



@QRYDCV

Query Decoder Version



@SETUPE0

**** Exit Setup**



@SETUPE1
Enter Setup

Query Bluetooth Hardware Version



#QRYBFW

Query Bluetooth Hardware Version

Query Data Formatter Version



@QRYDFM

Query Data Formatter Version

Query Hardware Version



@QRYHWW

Query Hardware Version

Query Serial Number



@QRYPSN

Query Serial Number



@SETUPE0
** Exit Setup



@SETUPE1

Enter Setup

Query Manufacturing Date



@QRYDAT

Query Manufacturing Date



@SETUPE0

**** Exit Setup**



@SETUPE1
Enter Setup

Query OEM Serial Number



@QRYESN
Query OEM Serial Number



@SETUPE0
** Exit Setup



@SETUPE1

Enter Setup

Query Remaining Battery of Scanner

After scanning the barcode below, the percentage of battery power remaining will be sent to the host device.



@WLSQPW

Query Remaining Battery of Scanner



@SETUPE0

**** Exit Setup**



@SETUPE1

Enter Setup

Chapter 4 Bluetooth Dongle

Introduction

There are three options for wireless connection between the bluetooth dongle and host device:

- ✧ Bluetooth Dongle HID Keyboard: The cradle's transmission is simulated as USB keyboard input with no need for command configuration or a driver. Barcode data could be entered by the virtual keyboard directly and it is also convenient for the host device to receive data.
- ✧ Bluetooth Dongle CDC: It is compliant with the standard USB CDC class specifications defined by the USB-IF and allows the host device to receive data in the way as a serial port does. A driver is needed when using this feature.
- ✧ Bluetooth Dongle HID POS (POS HID Barcode Scanner): It is based on the HID interface, with no need for a custom driver. It excels virtual keyboard in transmission speed.



@SETUPE0

**** Exit Setup**



@SETUPE1

Enter Setup

Bluetooth HID Keyboard

When the cradle is connected to the USB port on a host device, you can enable the USB HID Keyboard feature by scanning the barcode below. The cradle's transmission will be simulated as USB keyboard input. The Host receives keystrokes on the virtual keyboard. It works on a Plug and Play basis and no driver is required.



@INTERF19

**** Bluetooth Dongle HID Keyboard**



If the host device allows keyboard input, then no extra software is needed for HID Keyboard input.



@SETUPE0

**** Exit Setup**



@SETUPE1

Enter Setup

USB Country Keyboard Types

Keyboard layouts vary from country to country. The default setting is U.S. keyboard.



@KBWCTY0

**** U.S. (English)**



@KBWCTY1

Belgium



@KBWCTY2

Brazil



@KBWCTY3

Canada (French)



@KBWCTY4

Czechoslovakia



@KBWCTY5

Denmark



@KBWCTY6

Finland (Swedish)



@SETUPE0

**** Exit Setup**



@SETUPE1

Enter Setup



@KBWCTY7

France



@KBWCTY8

Germany/ Austria

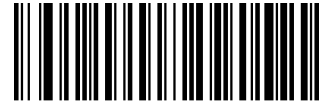

@KBWCTY9

Greece



@KBWCTY10

Hungary



@KBWCTY11

Israel (Hebrew)



@KBWCTY12

Italy



@KBWCTY13

Latin America/ South America



@KBWCTY14

Netherlands (Dutch)



@SETUPE0

**** Exit Setup**



@SETUPE1

Enter Setup



@KBWCTY15

Norway

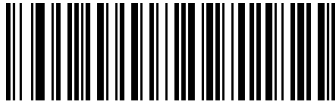

@KBWCTY16

Poland



@KBWCTY17

Portugal



@KBWCTY18

Romania



@KBWCTY19

Russia



@KBWCTY21

Slovakia



@KBWCTY22

Spain



@KBWCTY23

Sweden



@SETUPE0

**** Exit Setup**



@SETUPE1

Enter Setup



@KBWCTY24

Switzerland (German)

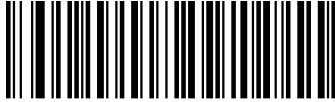

@KBWCTY25

Turkey_F

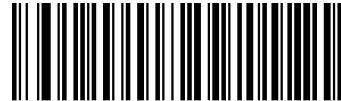

@KBWCTY26

Turkey_Q



@KBWCTY27

UK



@KBWCTY28

Japan



@SETUPE0

**** Exit Setup**



@SETUPE1

Enter Setup

Emulate ALT+Keypad

When **Emulate ALT+Keypad** is turned on, any character whose ASCII value is greater than or equal to 0x20 is sent over the numeric keypad no matter which keyboard type is selected.

1. ALT Make
2. Enter the number corresponding to a desired character on the keypad.
3. ALT Break

After **Emulate ALT+Keypad ON** is selected, you need to choose the code page with which the barcodes were created and to turn **Unicode Encoding** On or Off depending on the encoding used by the application software.



@KBWALTO

** Emulate ALT+Keypad OFF



@KBWALT1

Emulate ALT+Keypad ON



Since sending a character involves multiple keystroke emulations, this method appears less efficient.



Supposing **Emulate ALT+Keypad** is ON, **Unicode Encoding** is Off, **Code Page 1252 (West European Latin)** is selected, and **Emulate Keypad with Leading Zero** is Off, barcode data "ADF" (65/208/70) is sent as below:

"A" -- "ALT Make" + "065" + "ALT Break"

"D" -- "ALT Make" + "208" + "ALT Break"

"F" -- "ALT Make" + "070" + "ALT Break"



@SETUPE0

** Exit Setup



@SETUPE1

Enter Setup

Code Page

Code pages define the mapping of character codes to characters. If the data received does not display with the proper characters, it may be because the barcode being scanned was created using a code page that is different from the one the host program is expecting. If this is the case, select the code page with which the barcodes were created by scanning the appropriate barcode below. For PDF417, QR Code, Aztec and Data Matrix, besides setting the code page, you also need to set the character encoding in the “Character Encoding” section in Chapter 7. This feature is only effective when **Emulate ALT+Keypad** is turned on.



@KBWCPG0

**** Code Page 1252 (West European Latin)**



@KBWCPG1

Code Page 1251 (Cyrillic)



@KBWCPG2

Code Page 1250 (Central and East European Latin)



@KBWCPG3

Code Page 1253 (Greek)



@KBWCPG4

Code Page 1254 (Turkish)



@KBWCPG5

Code Page 1255 (Hebrew)



@SETUPE0

**** Exit Setup**



@SETUPE1

Enter Setup



@KBWCPG6

Code Page 1256 (Arabic)

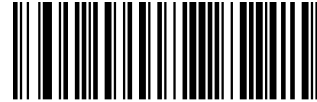

@KBWCPG7

Code Page 1257 (Baltic)



@KBWCPG8

Code Page 1258 (Vietnamese)



@KBWCPG9

Code Page 936 (Simplified Chinese, GB2312, GBK)



@KBWCPG10

Code Page 950 (Traditional Chinese, Big5)



@KBWCPG11

Code Page 874 (Thai)



@KBWCPG12

Code Page 932 (Japanese, Shift-JIS)



@SETUPE0

**** Exit Setup**



@SETUPE1

Enter Setup

Unicode Encoding

Different host program may use different character encodings for handling incoming barcode data. For instance, Microsoft Office Word uses Unicode encoding and therefore you should turn **Unicode Encoding** on, whereas Microsoft Office Excel or Notepad uses Code Page encoding and therefore you should turn **Unicode Encoding** off. This feature is only effective when **Emulate ALT+Keypad** is turned on.



@KBWCPU0

** Off



@KBWCPU1

On

Emulate Keypad with Leading Zero

You may turn this feature on to send character sequences sent over the numeric keypad as ISO characters which have a leading zero. For example, ASCII A transmits as "ALT MAKE" 0065 "ALT BREAK". This feature is only effective when **Emulate ALT+Keypad** is enabled.



@KBWALZ1

** On



@KBWALZ0

Off



@SETUPE0

** Exit Setup



@SETUPE1

Enter Setup

Function Key Mapping

When **Ctrl+ASCII Mode** is selected, function characters (0x00 - 0x1F) are sent as ASCII sequences.



@KBWFKM0

** Disable



@KBWFKM1

Ctrl+ASCII Mode



@KBWFKM2

Alt+Keypad Mode

Example

If **Ctrl+ASCII Mode** is selected and other parameters of USB HID Keyboard adopt factory defaults, barcode data “A<HT>(i.e. Horizontal Tab)F” (0x41/0x09/0x46) is sent as below:

“A” - Keystroke “A”.

<HT> - “Ctrl Make” + Keystroke “I” + “Ctrl Break”

“F” - Keystroke “F”

For some text editors, “Ctrl I” means italic convert. So the output may be “AF”.

If **Alt+Keypad Mode** is selected and other parameters of USB HID Keyboard adopt factory defaults, the data above is sent as below:

“A” - Keystroke “A”.

<HT> - “Alt Make” + Keystrokes “009” + “Alt Break”

“F” - Keystroke “F”



@SETUPE0

** Exit Setup



@SETUPE1

Enter Setup

ASCII Function Key Mapping Table

ASCII Function	ASCII Value (HEX)	Function Key Mapping Disabled	Ctrl+ASCII
NUL	00	Null	Ctrl+@
SOH	01	Keypad Enter	Ctrl+A
STX	02	Caps Lock	Ctrl+B
ETX	03	ALT	Ctrl+C
EOT	04	Null	Ctrl+D
ENQ	05	CTRL	Ctrl+E
ACK	06	Null	Ctrl+F
BEL	07	Enter	Ctrl+G
BS	08	Left Arrow	Ctrl+H
HT	09	Horizontal Tab	Ctrl+I
LF	0A	Down Arrow	Ctrl+J
VT	0B	Vertical Tab	Ctrl+K
FF	0C	Delete	Ctrl+L
CR	0D	Enter	Ctrl+M
SO	0E	Insert	Ctrl+N
SI	0F	Esc	Ctrl+O
DLE	10	F11	Ctrl+P
DC1	11	Home	Ctrl+Q
DC2	12	PrintScreen	Ctrl+R
DC3	13	Backspace	Ctrl+S
DC4	14	tab+shift	Ctrl+T
NAK	15	F12	Ctrl+U
SYN	16	F1	Ctrl+V
ETB	17	F2	Ctrl+W
CAN	18	F3	Ctrl+X
EM	19	F4	Ctrl+Y
SUB	1A	F5	Ctrl+Z
ESC	11	F6	Ctrl+[
FS	1C	F7	Ctrl+\
GS	1D	F8	Ctrl+]
RS	1E	F9	Ctrl+6
US	1F	F10	Ctrl+-



@SETUPE0

** Exit Setup



@SETUPE1

Enter Setup

ASCII Function Key Mapping Table (Continued)

The last five characters (0x1B~0x1F) in the table above apply to US keyboard layout only. The following chart provides the equivalents of these five characters for other countries.

Country	Ctrl+ASCII					
United States	Ctrl+[Ctrl+\	Ctrl+]	Ctrl+6	Ctrl+-	
Belgium	Ctrl+[Ctrl+<	Ctrl+]	Ctrl+6	Ctrl+-	
Scandinavia	Ctrl+8	Ctrl+<	Ctrl+9	Ctrl+6	Ctrl+-	
France	Ctrl+^	Ctrl+8	Ctrl+\$	Ctrl+6	Ctrl+=	
Germany		Ctrl+Ã	Ctrl++	Ctrl+6	Ctrl+-	
Italy		Ctrl+\	Ctrl++	Ctrl+6	Ctrl+-	
Switzerland		Ctrl+<	Ctrl+..	Ctrl+6	Ctrl+-	
United Kingdom	Ctrl+[Ctrl+ç	Ctrl+]	Ctrl+6	Ctrl+-	
Denmark	Ctrl+8	Ctrl+\	Ctrl+9	Ctrl+6	Ctrl+-	
Norway	Ctrl+8	Ctrl+\	Ctrl+9	Ctrl+6	Ctrl+-	
Spain	Ctrl+[Ctrl+\	Ctrl+]	Ctrl+6	Ctrl+-	



@SETUPE0

** Exit Setup



@SETUPE1

Enter Setup

Inter-Keystroke Delay

This parameter specifies the delay between emulated keystrokes.



@KBWDLY0

**** No Delay**



@KBWDLY40

Long Delay (40ms)

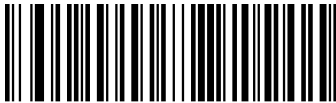

@KBWDLY20

Short Delay (20ms)



@SETUPE0

**** Exit Setup**



@SETUPE1

Enter Setup

Caps Lock

The **Caps Lock ON** option can invert upper and lower case characters contained in barcode data. This inversion occurs regardless of the state of Caps Lock key on the host device's keyboard.



@KBWCAP0

** Caps Lock OFF (Non-Japanese keyboard)



@KBWCAP1

Caps Lock ON (Non-Japanese keyboard)



Emulate ALT+Keypad ON/ Convert All to Upper Case/ Convert All to Lower Case prevails over Caps Lock ON.



When the **Caps Lock ON** feature is selected, barcode data "AbC" is transmitted as "aBc".



@SETUPE0

** Exit Setup



@SETUPE1

Enter Setup

Convert Case

You may scan the appropriate barcode below to convert all barcode data to your desired case.



@KBWCAS0

**** No Case Conversion**



@KBWCAS1

Convert All to Upper Case



@KBWCAS2

Convert All to Lower Case

E
xample

When the **Convert All to Lower Case** feature is enabled, barcode data "AbC" is transmitted as "abc".



If **Emulate ALT+Keypad ON** is selected, **Convert All to Lower Case** and **Convert All to Upper Case** do not function.



@SETUPE0

**** Exit Setup**



@SETUPE1

Enter Setup

Emulate Numeric Keypad



Do Not Emulate Numeric Keypad 1: Sending a number (0-9) is emulated as keystroke(s) on main keyboard.

Emulate Numeric Keypad 1: Sending a number (0-9) is emulated as keystroke(s) on numeric keypad. The state of Num Lock on the simulated numeric keypad is determined by its equivalent on the host device. If Num Lock on the host device is turned off, the output of simulated numeric keypad is function key instead of number.

Do Not Emulate Numeric Keypad 2: Sending "+", "-", "*", and "/" is emulated as keystroke(s) on main keyboard.

Emulate Numeric Keypad 2: Sending "+", "-", "*", and "/" is emulated as keystroke(s) on numeric keypad.



@KBWNUM0

**** Do Not Emulate Numeric Keypad 1**



@KBWNUM1

Emulate Numeric Keypad 1



@SETUPE0

**** Exit Setup**



@SETUPE1

Enter Setup



@KBWNCH0

**** Do Not Emulate Numeric Keypad 2**



@KBWNCH1

Emulate Numeric Keypad 2



Emulate ALT+Keypad ON prevails over **Emulate Numeric Keypad**.

E
xample

Supposing the **Emulate Numeric Keypad 1** feature is enabled:

if Num Lock on the host device is ON, "A4.5" is transmitted as "A4.5";

if Num Lock on the host device is OFF, "A4.5" is transmitted as ".A":

1. "A" is sent on main keyboard;
2. "4" is sent as the function key "Cursor Move to Left";
3. "." is sent on main keyboard;
4. "5" is not sent as it does not correspond to any function key.



@SETUPE0

**** Exit Setup**



@SETUPE1

Enter Setup

Polling Rate

This parameter specifies the polling rate for a USB keyboard. If the Host drops characters, change the polling rate to a bigger value.



@KBWPOR0

1ms

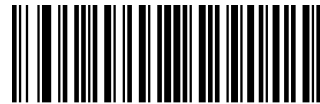

@KBWPOR1

2ms



@KBWPOR2

3ms

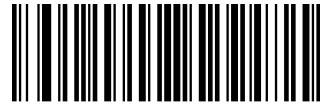

@KBWPOR3

** 4ms



@KBWPOR4

5ms



@KBWPOR5

6ms



@KBWPOR6

7ms



@SETUPE0

** Exit Setup



@SETUPE1

Enter Setup



@KBWPOR7

8ms



@KBWPOR8

9ms

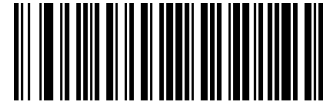

@KBWPOR9

10ms



@SETUPE0

**** Exit Setup**



@SETUPE1

Enter Setup

Bluetooth Dongle CDC

If your cradle is connected to the USB port on a host device, the USB CDC feature allows the host device to receive data in the way as a serial port does. A driver is needed when using this feature. You may download it from our website at www.newlandaidc.com.



@INTERF17

Bluetooth Dongle CDC



@SETUPE0

**** Exit Setup**



@SETUPE1

Enter Setup

Bluetooth Dongle HID POS (POS HID Barcode Scanner)

Introduction

The HID-POS interface is recommended for new application programs. It can send up to 56 characters in a single USB report and appears more efficient than keyboard emulation.

Features:

1. HID based, no custom driver required.
2. Way more efficient in communication than keyboard emulation.



@INTERF18

Bluetooth Dongle HID-POS

Access the scanner with Your Program

Use CreateFile to access the scanner as a HID device and then use ReadFile to deliver the scanned data to the application program. Use WriteFile to send data to the cradle.

For detailed information about USB and HID interfaces, go to www.USB.org.



@SETUPE0

**** Exit Setup**



@SETUPE1

Enter Setup

Acquire Scanned Data

After a barcode is decoded, the cradle sends an input report as below:

Byte	Bit							
	7	6	5	4	3	2	1	0
0	Report ID = 0x02							
1	Barcode Length							
2-57	Decoded Data (1-56)							
58-61	Reserved							
62	Newland Symbology Identifier or N/C: 0x00							
63	-	-	-	-	-	-	-	Decoded data continued

Send Command to the Cradle

This output report is used to send commands to the cradle. All programming commands can be used.

Byte	Bit							
	7	6	5	4	3	2	1	0
0	Report ID = 0x04							
1	Length of command							
2-63	Command (1-62)							



@SETUPE0

** Exit Setup



@SETUPE1

Enter Setup

VID/PID

USB uses VID (Vendor ID) and PID (Product ID) to identify and locate a device. The VID is assigned by USB Implementers Forum. Newland's vendor ID is 1EAB (Hex). A range of PIDs are used for each Newland product family. Every PID contains a base number and interface type (keyboard, COM port, etc)

Product	Interface	PID (Hex)	PID (Dec)
SD32	Bluetooth Dongle HID Keyboard	3322	13090
	Bluetooth Dongle HID POS	3310	13072
	Bluetooth Dongle CDC	3306	13062



@SETUPE0

**** Exit Setup**

Chapter 5 Wireless Communication

Default Setting of Wireless Communication

Clear Pairing Information of Scanner





@SETUPE1

Enter Setup

Operating Modes

The scanner provides the following operating modes:

Bluetooth HID/BLE mode allows the scanner to establish Bluetooth connection via Easyconnect.

Bluetooth HID Mode allows your scanner to communicate with a remote host using Bluetooth. You must first pair your scanner to the host before these two Bluetooth devices can communicate with each other. All features available for USB HID Keyboard are applicable to Bluetooth HID. Pressing the trigger twice can turn on/off iPhone and iPad's virtual keyboard.

Note: The pairing information in the scanner and the current host need to be cleared before connecting with other Bluetooth devices.

Scanner scan Clear Pairing Info on Scanner barcode, and the host delete the pairing information.

Bluetooth BLE Mode: The Bluetooth low energy communication mode can communicate with the host app developed based on the Bluetooth SDK. In this mode, the scanner provides a serial transparent transmission service based on GATT service.

Cradle Mode allows your scanner to communicate with a remote host by pairing with an HR3280-BT cradle.

Cradle Mode is available only for pairing with the CD32 cradle shipped with the HR3280-BT-C



@INTERF10

Bluetooth HID Mode



@INTERF11

Bluetooth BLE



@INTERF12

Cradle Mode



@SETUPE0

** Exit Setup



@SETUPE1

Enter Setup

Batch Mode

Batch Mode Options

Off: The scanner attempts to transmit every barcode you scan. When you are out of service range, the scanned data will be lost.

Automatic Batch Mode: When in service range, the scanner attempts to transmit every barcode you scan. When out of range, the scanner stores the scanned data in the flash memory. Once you are back to service range, the scanner will automatically transmit the stored data and then remove it from the flash memory after transmission is done.

Manual Batch Mode: Scanned data will be stored in the flash memory no matter whether you are in service range or not. You may send the stored data to the host in the following ways: scan the Transmit Stored Data barcode. The scanner will automatically remove the stored data from the flash memory after transmission is done if the Auto Clear Stored Data after Transmission feature is turned on.

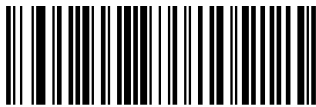

@WLSBAT0

**Off



@WLSBAT1

Automatic Batch Mode



@WLSBAT2

Manual Batch Mode



@SETUPE0

** Exit Setup



@SETUPE1

Enter Setup

Prevent Same Barcode Storage

This feature is available only when scanning barcodes in the Automatic or Manual Batch mode.

On: The scanner discards the data and generates an error beep when encountering a barcode that has existed in the flash memory.

Off: The scanner stores the data when encountering a barcode that has existed in the flash memory.



@WLSSE0

**** Off**



@WLSSE1

On



@SETUPE0

**** Exit Setup**

Batch Mode Transmit Delay

Sometimes when multiple barcodes stored in the flash memory are sent to the host, the transmission of those barcodes is too fast for the application to process. To program a transmit delay between barcodes, scan one of the following delays.



@WLSBTD0

**** No Transmit Delay (0ms)**



@WLSBTD50

Short Transmit Delay (50ms)



@WLSBTD100

Medium Transmit Delay (100ms)



@WLSBTD150

Long Transmit Delay (150ms)



@WLSBTD

Custom Transmit Delay (0-10,000ms)

E *xample*

Set the batch mode transmit delay to 200ms:

1. Scan the **Enter Setup** barcode.
2. Scan the **Custom Transmit Delay** barcode.
3. Scan the numeric barcodes “2”, “0” and “0” from the “Digit Barcodes” section in Appendix.
4. Scan the **Save** barcode from the “Save/Cancel Barcodes” section in Appendix.
5. Scan the **Exit Setup** barcode.



@SETUPE1

Enter Setup

End of Transmission Message for Batch Mode

You may scan the appropriate barcode below to select whether or not to send an end of transmission message (user-programmable) to notify the host when transmission of all stored data is done. This feature is only available to data transmission initiated manually under the Manual Batch mode.



@WLSBTT0

**** End of Transmission Message Off**



@WLSBTT1

End of Transmission Message On

An end of transmission message can contain up to 10 characters (HEX values from 0x00 to 0xFF). To set an end of transmission message, scan the **Set End of Transmission Message** barcode, the numeric barcodes representing the hexadecimal values of desired character(s) and the **Save** barcode. The default setting is "EOT".



@WLSBTC

Set End of Transmission Message

E
example

Set the end of transmission message to "END" (HEX: 0x45, 0x4E, 0x44):

1. Scan the **Enter Setup** barcode.
2. Scan the **Set End of Transmission Message** barcode.
3. Scan the numeric barcodes "4", "5", "4", "E", "4" and "4" from the "Digit Barcodes" section in Appendix.
4. Scan the **Save** barcode from the "Save/Cancel Barcodes" section in Appendix.
5. Scan the **Exit Setup** barcode.



@SETUPE0

**** Exit Setup**



@SETUPE1

Enter Setup

Transmit Stored Data

You may scan the barcode below to send the stored data in the flash memory to the host. This feature is only available to the Manual Batch mode.



@WSSBT

Transmit Stored Data

Auto Clear Stored Data after Transmission

You may scan the appropriate barcode below to choose whether to clear or keep the stored data in the flash memory after transmission. This feature is only available to the Manual Batch mode.



@WLSCLE0

**** Off**



@WLSCLE1

On

Query/Clear Stored Data in Flash



@WLSQFC

Query the Number of Stored Barcodes



@WLSCLF

Clear All Stored Data



@SETUPE0

**** Exit Setup**



@SETUPE1

Enter Setup

Retransmission

If the Transmission feature is on, the scanner awaits an ACK response from the host following a data packet transmission, and resends the packet when it receives a NAK response or the retransmission timeout expires. Note that Data Packing must be enabled for this feature to function (See the “Data Packing Options” in Chapter 9 to learn how to enable it).



@WLSRTE0

**** Retransmission Off**



@WLSRTE1

Retransmission On



@SETUPE0

**** Exit Setup**



@SETUPE1

Enter Setup

Auto Power-Off Timeout

Auto Power-off Timeout specifies the amount of time it takes before the scanner automatically powers off from inactivity.



@WLSAPO0

**** 5 Minutes**



@WLSAPO1

10 Minutes



@WLSAPO2

20 Mintues



@WLSAPO3

30 Mintues



@WLSAPO4

60 Minutes



@WLSAPO5

Disable Auto Power-off



@SETUPE0

**** Exit Setup**



@SETUPE1

Enter Setup

Set Scanner Name

You may scan the below barcode to set the name of your scanner. The maximum length is 5 characters (HEX values from 0x20 to 0x7E). The default scanner name is "00000".



@WLSNAM

Scanner Name

E
example

If setting the scanner name as "0AB00":

1. Scan the Enter Setup barcode
2. Scan the Scanner Name barcode
3. Scan the numeric barcode "3" "0" "4" "1" "4" "2" from the "Digit Barcodes" section in Appendix
4. Scan the **Save** barcode from the "Save/Cancel Barcodes" section in Appendix
5. Scan the Exit Setup barcode



@SETUPE0

** Exit Setup



@SETUPE1

Enter Setup

Set Date and Time



@WLSTMS

Set Date and Time

E
example

Set Date and Time to “20201021010101”:

1. Scan the **Enter Setup** barcode.
2. Scan the **Set Date and Time** barcode.
3. Scan the numeric barcodes “2”, “0”, “2”, “0”, “1”, “0”, “2”, “1”, “0”, “1”, “0”, “1”, “0” and “1” from the “Digit Barcodes” section in Appendix.
4. Scan the **Save** barcode from the “Save/Cancel Barcodes” section in Appendix.
5. Scan the **Exit Setup** barcode.

Query Current Date and Time

After scanning the barcode below, the current date and time in YYYYMMDDHHMMSS format will be sent to the host device.

For example, query result “20180205103011” means February 5th 2018 10:30:11.



@WLSTMQ

Query Current Date and Time



@SETUPE0

** Exit Setup



@SETUPE1

Enter Setup

Time Stamp

You can select whether or not to send date & time before each scanned data by scanning the appropriate barcode below.



@WLSTSE0

**** Do Not Send Time Stamp**



@WLSTSE1

Send Time Stamp

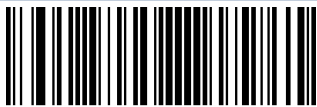

@SETUPE0

**** Exit Setup**



@SETUPE1

Enter Setup

Set Time Stamp Format



@WLSTSF0

**** Format 1: (YYYY/MM/DD, HH: MM: SS)**

(example: 2018/01/23, 10:30:20)



@WLSTSF1

Format 2: (DD/MM/YYYY/, HH: MM: SS)

(example: 23/01/2018, 10:30:20)



@WLSTSF2

Format 3: (MM/DD/YYYY,HH:MM:SS)

(example: 01/23/2018, 10:30:20)



@SETUPE0

**** Exit Setup**



@SETUPE1
Enter Setup

Chapter 6 Symbologies

Introduction

Every symbology (barcode type) has its own unique attributes. This chapter provides programming barcodes for configuring the scanner so that it can identify various symbologies. It is recommended to disable those that are rarely used to increase the efficiency of the scanner.

Global Settings

Enable/Disable All Symbologies

If the **Disable All Symbologies** feature is enabled, the scanner will not be able to read any non-programming barcodes except the programming barcodes.



@ALLENA1
Enable All Symbologies



@ALLENA0
Disable All Symbologies

Enable/Disable 1D Symbologies



@ALL1DC1
Enable 1D Symbologies



@ALL1DC0
Disable 1D Symbologies



@SETUPE0
** Exit Setup



@SETUPE1

Enter Setup

Enable/Disable 2D Symbologies



@ALL2DC1

Enable 2D Symbologies



@ALL2DC0

Disable 2D Symbologies

Enable/Disable Postal Symbologies



@ALLPST1

Enable All Postal Symbologies



@ALLPST0

Disable All Postal Symbologies



@SETUPE0

**** Exit Setup**



@SETUPE1
Enter Setup

Surround GS1 Application Identifiers (AI's) with Parentheses

When **Surround GS1 AI's with Parentheses** is selected, each application identifier (AI) contained in scanned data will be enclosed in parentheses in the output message.



@GS1AIP0

**** Do Not Surround GS1 AI's with Parentheses**



@GS1AIP1

Surround GS1 AI's with Parentheses

E
xample

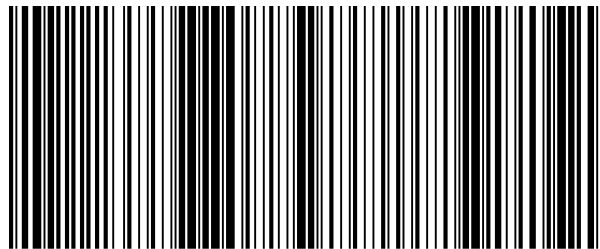

(01) 0 0614141 99999 6 (10) 10ABCEDF123456

If **Surround GS1 AI's with Parentheses** is selected, the barcode above is output as

(01)00614141999996(10)10ABCEDF123456.

If **Do Not Surround GS1 AI's with Parentheses** is selected, the barcode above is output as

01006141419999961010ABCEDF123456.



@SETUPE0
**** Exit Setup**



@SETUPE1
Enter Setup

Transmit GS1 Check Character



@GS1OCK0
Disable



@GS1OCK1
** Enable

E *xample*

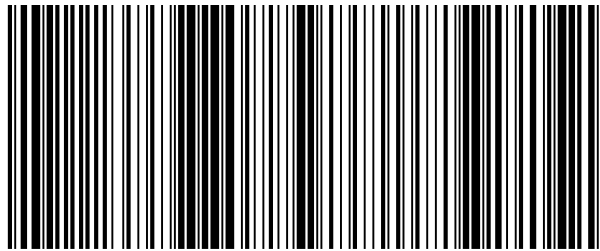

(01) 0 0614141 99999 6 (10) 10ABCEDF123456

If **Transmit GS1 Check Character** is Enabled, the barcode above is output as
01006141419999961010ABCEDF123456.

If **Transmit GS1 Check Character** is Disabled, the barcode above is output as
0100614141999991010ABCEDF123456.



@SETUPE0
** Exit Setup



@SETUPE1

Enter Setup

Code 128

Restore Factory Defaults



@128DEF

****Restore the Factory Defaults of Code 128**

Enable/Disable Code 128



@128ENA1

**** Enable Code 128**



@128ENA0

Disable Code 128



If the scanner fails to identify Code 128 barcodes, you may first try this solution by scanning the **Enter Setup** barcode and then **Enable Code 128** barcode.



@SETUPE0

**** Exit Setup**



@SETUPE1

Enter Setup

Set Length Range for Code 128

The scanner can be configured to only decode Code 128 barcodes with lengths that fall between (inclusive) the minimum and maximum lengths. To accomplish it, you need to set the minimum and maximum lengths.



@128MIN

Set the Minimum Length (Default: 1)



@128MAX

Set the Maximum Length (Default: 48)



If minimum length is set to be greater than maximum length, the scanner only decodes Code 128 barcodes with either the minimum or maximum length. If minimum length is same as maximum length, only Code 128 barcodes with that length are to be decoded.



Set the scanner to decode Code 128 barcodes containing between 8 and 12 characters:

1. Scan the **Enter Setup** barcode.
2. Scan the **Set the Minimum Length** barcode.
3. Scan the numeric barcode “8” from the “Digit Barcodes” section in Appendix.
4. Scan the **Save** barcode from the “Save/Cancel Barcodes” section in Appendix.
5. Scan the **Set the Maximum Length** barcode.
6. Scan the numeric barcodes “1” and “2” from the “Digit Barcodes” section in Appendix.
7. Scan the **Save** barcode from the “Save/Cancel Barcodes” section in Appendix.
8. Scan the **Exit Setup** barcode.



@SETUPE0

** Exit Setup



@SETUPE1
Enter Setup

EAN-8

Restore Factory Defaults



@EA8DEF

**** Restore the Factory Defaults of EAN-8**

Enable/Disable EAN-8



@EA8ENA1

**** Enable EAN-8**

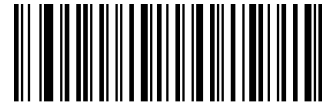

@EA8ENA0

Disable EAN-8



If the scanner fails to identify EAN-8 barcodes, you may first try this solution by scanning the **Enter Setup** barcode and then **Enable EAN-8** barcode.

Transmit Check Character

EAN-8 is 8 digits in length with the last one as its check character used to verify the integrity of the data.



@EA8CHK2

**** Transmit EAN-8 Check Character**

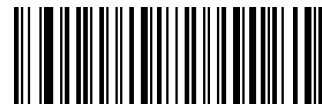

@EA8CHK1

Do Not Transmit EAN-8 Check Character



@SETUPE0

**** Exit Setup**



@SETUPE1

Enter Setup

2-Digit Add-On Code

An EAN-8 barcode can be augmented with a two-digit add-on code to form a new one. In the example below, the part surrounded by blue dotted line is an EAN-8 barcode while the part circled by red dotted line is a two-digit add-on code.



@EA8AD20

**** Disable 2-Digit Add-On Code**



@EA8AD21

Enable 2-Digit Add-On Code



Disable 2-Digit Add-On Code: The scanner decodes EAN-8 and ignores the add-on code when presented with an EAN-8 plus 2-digit add-on barcode. It can also decode EAN-8 barcodes without 2-digit add-on codes.

Enable 2-Digit Add-On Code: The scanner decodes a mix of EAN-8 barcodes with and without 2-digit add-on codes.



@SETUPE0

**** Exit Setup**



@SETUPE1

Enter Setup

5-Digit Add-On Code

An EAN-8 barcode can be augmented with a five-digit add-on code to form a new one. In the example below, the part surrounded by blue dotted line is an EAN-8 barcode while the part circled by red dotted line is a five-digit add-on code.



@EA8AD50

** Disable 5-Digit Add-On Code



@EA8AD51

Enable 5-Digit Add-On Code



Disable 5-Digit Add-On Code: The scanner decodes EAN-8 and ignores the add-on code when presented with an EAN-8 plus 5-digit add-on barcode. It can also decode EAN-8 barcodes without 5-digit add-on codes.

Enable 5-Digit Add-On Code: The scanner decodes a mix of EAN-8 barcodes with and without 5-digit add-on codes.



@SETUPE0

** Exit Setup



@SETUPE1

Enter Setup

Add-On Code Required

When **EAN-8 Add-On Code Required** is selected, the scanner will only read EAN-8 barcodes that contain add-on codes.



@EA8REQ0

**** EAN-8 Add-On Code Not Required**



@E13REQ1

EAN-8 Add-On Code Required

Convert EAN-8 to EAN-13

Convert EAN-8 to EAN-13: Convert EAN-8 decoded data to EAN-13 format before transmission. After conversion, the data follows EAN-13 format and is affected by EAN-13 programming selections (e.g., Check Character).

Do Not Convert EAN-8 to EAN-13: EAN-8 decoded data is transmitted as EAN-8 data, without conversion.



@EA8EXP0

**** Do Not Convert EAN-8 to EAN-13**



@EA8EXP1

Convert EAN-8 to EAN-13



@SETUPE0

**** Exit Setup**



@SETUPE1

Enter Setup

EAN-13

Restore Factory Defaults



@E13DEF

**** Restore the Factory Defaults of EAN-13**

Enable/Disable EAN-13



@E13ENA1

**** Enable EAN-13**



@E13ENA0

Disable EAN-13



If the scanner fails to identify EAN-13 barcodes, you may first try this solution by scanning the **Enter Setup** barcode and then **Enable EAN-13** barcode.



@SETUPE0

**** Exit Setup**



@SETUPE1

Enter Setup

Transmit Check Character



@E13CHK2

** Transmit EAN-13 Check Character



@E13CHK1

Do Not Transmit EAN-13 Check Character

2-Digit Add-On Code

An EAN-13 barcode can be augmented with a two-digit add-on code to form a new one. In the example below, the part surrounded by blue dotted line is an EAN-13 barcode while the part circled by red dotted line is a two-digit add-on code.



@E13AD20

** Disable 2-Digit Add-On Code



@E13AD21

Enable 2-Digit Add-On Code



Disable 2-Digit Add-On Code: The scanner decodes EAN-13 and ignores the add-on code when presented with an EAN-13 plus 2-digit add-on barcode. It can also decode EAN-13 barcodes without 2-digit add-on codes.

Enable 2-Digit Add-On Code: The scanner decodes a mix of EAN-13 barcodes with and without 2-digit add-on codes.



@SETUPE0

** Exit Setup



@SETUPE1
Enter Setup

5-Digit Add-On Code

An EAN-13 barcode can be augmented with a five-digit add-on code to form a new one. In the example below, the part surrounded by blue dotted line is an EAN-13 barcode while the part circled by red dotted line is a five-digit add-on code.



@E13AD50
**** Disable 5-Digit Add-On Code**



@E13AD51
Enable 5-Digit Add-On Code



Disable 5-Digit Add-On Code: The scanner decodes EAN-13 and ignores the add-on code when presented with an EAN-13 plus 5-digit add-on barcode. It can also decode EAN-13 barcodes without 5-digit add-on codes.

Enable 5-Digit Add-On Code: The scanner decodes a mix of EAN-13 barcodes with and without 5-digit add-on codes.

Add-On Code Required

When **EAN-13 Add-On Code Required** is selected, the scanner will only read EAN-13 barcodes that contain add-on codes.



@E13REQ0
**** EAN-13 Add-On Code Not Required**



@E13REQ1
EAN-13 Add-On Code Required



@SETUPE0
**** Exit Setup**



@SETUPE1

Enter Setup

EAN-13 Beginning with 290 Add-On Code Required

This setting programs the scanner to require an add-on code (2-digit or 5-digit) on EAN-13 barcodes that begin with “290”. The following settings can be programmed:

Require Add-On Code: All EAN-13 barcodes that begin with “290” must have a 2-digit or 5-digit add-on code. The EAN-13 barcode with the add-on code is then transmitted. If the required add-on code is not found, the EAN-13 barcode is discarded.

Do Not Require Add-On Code: If you have selected **Require Add-On Code**, and you want to disable this feature, scan **Do Not Require Add-On Code**. EAN-13 barcodes are handled, depending on your selection for the “Add-On Code Required” feature.



@E132900

**** Do Not Require Add-On Code**



@E132901

Require Add-On Code

EAN-13 Beginning with 378/379 Add-On Code Required

This setting programs the scanner to require an add-on code (2-digit or 5-digit) on EAN-13 barcodes that begin with a “378” or “379”. The following settings can be programmed:

Require Add-On Code: All EAN-13 barcodes that begin with a “378” or “379” must have a 2-digit or 5-digit add-on code. The EAN-13 barcode with the add-on code is then transmitted. If the required add-on code is not found, the EAN-13 barcode is discarded.

Do Not Require Add-On Code: If you have selected **Require Add-On Code**, and you want to disable this feature, scan **Do Not Require Add-On Code**. EAN-13 barcodes are handled, depending on your selection for the “Add-On Code Required” feature.



@E133780

**** Do Not Require Add-On Code**



@E133781

Require Add-On Code



@SETUPE0

**** Exit Setup**



@SETUPE1
Enter Setup

EAN-13 Beginning with 414/419 Add-On Code Required

This setting programs the scanner to require an add-on code (2-digit or 5-digit) on EAN-13 barcodes that begin with a “414” or “419”. The following settings can be programmed:

Require Add-On Code: All EAN-13 barcodes that begin with a “414” or “419” must have a 2-digit or 5-digit add-on code. The EAN-13 barcode with the add-on code is then transmitted. If the required add-on code is not found, the EAN-13 barcode is discarded.

Do Not Require Add-On Code: If you have selected **Require Add-On Code**, and you want to disable this feature, scan **Do Not Require Add-On Code**. EAN-13 barcodes are handled, depending on your selection for the “Add-On Code Required” feature.



** Do Not Require Add-On Code



Require Add-On Code

EAN-13 Beginning with 434/439 Add-On Code Required

This setting programs the scanner to require an add-on code (2-digit or 5-digit) on EAN-13 barcodes that begin with a “434” or “439”. The following settings can be programmed:

Require Add-On Code: All EAN-13 barcodes that begin with a “434” or “439” must have a 2-digit or 5-digit add-on code. The EAN-13 barcode with the add-on code is then transmitted. If the required add-on code is not found, the EAN-13 barcode is discarded.

Do Not Require Add-On Code: If you have selected **Require Add-On Code**, and you want to disable this feature, scan **Do Not Require Add-On Code**. EAN-13 barcodes are handled, depending on your selection for the “Add-On Code Required” feature.



** Do Not Require Add-On Code



@E134341



@SETUPE0
** Exit Setup



Require Add-On Code
@SETUPE1
Enter Setup



@SETUPE0
**** Exit Setup**



@SETUPE1
Enter Setup

EAN-13 Beginning with 977 Add-On Code Required

This setting programs the scanner to require an add-on code (2-digit or 5-digit) on EAN-13 barcodes that begin with “977”. The following settings can be programmed:

Require Add-On Code: All EAN-13 barcodes that begin with “977” must have a 2-digit or 5-digit add-on code. The EAN-13 barcode with the add-on code is then transmitted. If the required add-on code is not found, the EAN-13 barcode is discarded.

Do Not Require Add-On Code: If you have selected **Require Add-On Code**, and you want to disable this feature, scan **Do Not Require Add-On Code**. EAN-13 barcodes are handled, depending on your selection for the “Add-On Code Required” feature.



** Do Not Require Add-On Code



Require Add-On Code

EAN-13 Beginning with 978 Add-On Code Required

This setting programs the scanner to require an add-on code (2-digit or 5-digit) on EAN-13 barcodes that begin with “978”. The following settings can be programmed:

Require Add-On Code: All EAN-13 barcodes that begin with “978” must have a 2-digit or 5-digit add-on code. The EAN-13 barcode with the add-on code is then transmitted. If the required add-on code is not found, the EAN-13 barcode is discarded.

Do Not Require Add-On Code: If you have selected **Require Add-On Code**, and you want to disable this feature, scan **Do Not Require Add-On Code**. EAN-13 barcodes are handled, depending on your selection for the “Add-On Code Required” feature.



** Do Not Require Add-On Code



Require Add-On Code



@SETUPE0
** Exit Setup



@SETUPE1

Enter Setup

EAN-13 Beginning with 979 Add-On Code Required

This setting programs the scanner to require an add-on code (2-digit or 5-digit) on EAN-13 barcodes that begin with “979”.

The following settings can be programmed:

Require Add-On Code: All EAN-13 barcodes that begin with “979” must have a 2-digit or 5-digit add-on code. The EAN-13 barcode with the add-on code is then transmitted. If the required add-on code is not found, the EAN-13 barcode is discarded.

Do Not Require Add-On Code: If you have selected **Require Add-On Code**, and you want to disable this feature, scan **Do Not Require Add-On Code**. EAN-13 barcodes are handled, depending on your selection for the “Add-On Code Required” feature.



@E139790

**** Do Not Require Add-On Code**



@E139791

Require Add-On Code



@SETUPE0

**** Exit Setup**



@SETUPE1

Enter Setup

UPC-E

Restore Factory Defaults



@UPEDEF

**** Restore the Factory Defaults of UPC-E**

Enable/Disable UPC-E



@UPEEN01

**** Enable UPC-E0**



@UPEEN00

Disable UPC-E0



@UPEEN11

Enable UPC-E1



@UPEEN10

**** Disable UPC-E1**



If the scanner fails to identify UPC-E0/UPC-E1 barcodes, you may first try this solution by scanning the **Enter Setup** barcode and then **Enable UPC-E0/UPC-E1** barcode.



@SETUPE0

**** Exit Setup**



@SETUPE1

Enter Setup

Transmit Check Character

UPC-E is 8 digits in length with the last one as its check character used to verify the integrity of the data.



@UPECHK2

**** Transmit UPC-E Check Character**



@UPECHK1

Do Not Transmit UPC-E Check Character

2-Digit Add-On Code

A UPC-E barcode can be augmented with a two-digit add-on code to form a new one. In the example below, the part surrounded by blue dotted line is a UPC-E barcode while the part circled by red dotted line is a two-digit add-on code.



@UPEAD20

**** Disable 2-Digit Add-On Code**



@UPEAD21

Enable 2-Digit Add-On Code



Disable 2-Digit Add-On Code: The scanner decodes UPC-E and ignores the add-on code when presented with a UPC-E plus 2-digit add-on barcode. It can also decode UPC-E barcodes without 2-digit add-on codes.

Enable 2-Digit Add-On Code: The scanner decodes a mix of UPC-E barcodes with and without 2-digit add-on codes.



@SETUPE0

**** Exit Setup**



@SETUPE1

Enter Setup

5-Digit Add-On Code

A UPC-E barcode can be augmented with a five-digit add-on code to form a new one. In the example below, the part surrounded by blue dotted line is a UPC-E barcode while the part circled by red dotted line is a five-digit add-on code.



@UPEAD50

** Disable 5-Digit Add-On Code



@UPEAD51

Enable 5-Digit Add-On Code



Disable 5-Digit Add-On Code: The scanner decodes UPC-E and ignores the add-on code when presented with a UPC-E plus 5-digit add-on barcode. It can also decode UPC-E barcodes without 5-digit add-on codes.

Enable 5-Digit Add-On Code: The scanner decodes a mix of UPC-E barcodes with and without 5-digit add-on codes.



@SETUPE0

** Exit Setup



@SETUPE1

Enter Setup

Add-On Code Required

When **UPC-E Add-On Code Required** is selected, the scanner will only read UPC-E barcodes that contain add-on codes.



@UPEREQ0

**** UPC-E Add-On Code Not Required**



@UPEREQ1

UPC-E Add-On Code Required

Transmit Preamble Character

Preamble characters (Country Code and System Character) can be transmitted as part of a UPC-E barcode. Select one of the following options for transmitting UPC-E preamble to the host device: transmit system character only, transmit system character and country code ("0" for USA), or transmit no preamble.



@UPEPRE1

System Character



@UPEPRE0

**** No Preamble**



@UPEPRE2

System Character & Country Code

Convert UPC-E to UPC-A

Convert UPC-E to UPC-A: Convert UPC-E (zero suppressed) decoded data to UPC-A format before transmission. After conversion, the data follows UPC-A format and is affected by UPC-A programming selections (e.g., Preamble, Check Character).



@SETUPE0

**** Exit Setup**



@SETUPE1

Enter Setup

Do Not Convert UPC-E to UPC-A: UPC-E decoded data is transmitted as UPC-E data, without conversion.



@UPEEXP0

**** Do Not Convert UPC-E to UPC-A**



@UPEEXP1

Convert UPC-E to UPC-A



@SETUPE0

**** Exit Setup**



@SETUPE1

Enter Setup

UPC-A

Restore Factory Defaults



@UPADEF

Restore the Factory Defaults of UPC-A

Enable/Disable UPC-A



@UPAENA1

** Enable UPC-A



@UPAENA0

Disable UPC-A



If the scanner fails to identify UPC-A barcodes, you may first try this solution by scanning the **Enter Setup** barcode and then **Enable UPC-A** barcode.

Transmit Check Character

UPC-A is 13 digits in length with the last one as its check character used to verify the integrity of the data.



@UPACHK2

** Transmit UPC-A Check Character

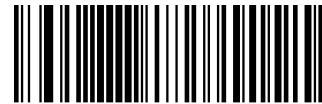

@UPACHK1

Do Not Transmit UPC-A Check Character



@SETUPE0

** Exit Setup



@SETUPE1

Enter Setup

2-Digit Add-On Code

A UPC-A barcode can be augmented with a two-digit add-on code to form a new one. In the example below, the part surrounded by blue dotted line is a UPC-A barcode while the part circled by red dotted line is a two-digit add-on code.



@UPAAD20

** Disable 2-Digit Add-On Code



@UPAAD21

Enable 2-Digit Add-On Code



Disable 2-Digit Add-On Code: The scanner decodes UPC-A and ignores the add-on code when presented with a UPC-A plus 2-digit add-on barcode. It can also decode UPC-A barcodes without 2-digit add-on codes.

Enable 2-Digit Add-On Code: The scanner decodes a mix of UPC-A barcodes with and without 2-digit add-on codes.



@SETUPE0

** Exit Setup



@SETUPE1

Enter Setup

5-Digit Add-On Code

A UPC-A barcode can be augmented with a five-digit add-on code to form a new one. In the example below, the part surrounded by blue dotted line is a UPC-A barcode while the part circled by red dotted line is a five-digit add-on code.



@UPAAD50

** Disable 5-Digit Add-On Code



@UPAAD51

Enable 5-Digit Add-On Code



Disable 5-Digit Add-On Code: The scanner decodes UPC-A and ignores the add-on code when presented with a UPC-A plus 5-digit add-on barcode. It can also decode UPC-A barcodes without 5-digit add-on codes.

Enable 5-Digit Add-On Code: The scanner decodes a mix of UPC-A barcodes with and without 5-digit add-on codes.



@SETUPE0

** Exit Setup



@SETUPE1

Enter Setup

Add-On Code Required

When **UPC-A Add-On Code Required** is selected, the scanner will only read UPC-A barcodes that contain add-on codes.



@UPAREQ0

**** UPC-A Add-On Code Not Required**

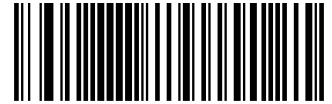

@UPAREQ1

UPC-A Add-On Code Required

Transmit Preamble Character

Preamble characters (Country Code and System Character) can be transmitted as part of a UPC-A barcode. Select one of the following options for transmitting UPC-A preamble to the host device: transmit system character only, transmit system character and country code ("0" for USA), or transmit no preamble.



@UPAPRE0

No Preamble



@UPAPRE1

**** System Character**



@UPAPRE2

System Character & Country Code



@SETUPE0

**** Exit Setup**



@SETUPE1

Enter Setup

Coupon

UPC-A/EAN-13 with Extended Coupon Code

The following three types of coupon code + extended coupon code are supported:

- ◇ UPC-A (starting with “5”) + GS1-128
- ◇ UPC-A (starting with “5”) + GS1 Databar
- ◇ EAN-13 (starting with “99”) + GS1-128

Use the appropriate barcode below to enable or disable UPC-A/EAN-13 with Extended Coupon Code. When left on the default setting (**Off**), the scanner treats Coupon Codes and Extended Coupon Codes as single barcodes.

If you scan the **Allow Concatenation** code, when the scanner sees the coupon code and the extended coupon code in a single scan, it transmits both as separate symbologies. Otherwise, it transmits the first coupon code it reads.

If you scan the **Require Concatenation** code, the scanner must see and read the coupon code and extended coupon code in a single read to transmit the data. No data is output unless both codes are read.



@CPNENA0

** Off



@CPNENA1

Allow Concatenation



@CPNENA2

Require Concatenation



When using the UPC-A Coupon feature, please ensure that **System Character** or **System Character & Country Code** is selected for the “Transmit UPC-A Preamble Character” feature.



@SETUPE0

** Exit Setup



@SETUPE1

Enter Setup

Coupon GS1 Databar Output

If you scan coupons that have both UPC and GS1 Databar codes, you may wish to scan and output only the data from the GS1 Databar code. Scan the **GS1 Output On** barcode below to scan and output only the GS1 Databar code data.

When **GS1 Output Off** is selected, coupons that have both UPC and GS1 Databar codes are transmitted depending on your selection for the “UPC-A/EAN-13 with Extended Coupon Code” feature.



@CPNGS10

** GS1 Output Off



@CPNGS11

GS1 Output On



When using the UPC-A Coupon feature, please ensure that **System Character** or **System Character & Country Code** is selected for the “Transmit UPC-A Preamble Character” feature.



@SETUPE0

** Exit Setup



@SETUPE1

Enter Setup

Interleaved 2 of 5

Restore Factory Defaults



@I25DEF

Restore the Factory Defaults of Interleaved 2 of 5

Enable/Disable Interleaved 2 of 5



@I25ENA1

**** Enable Interleaved 2 of 5**



@I25ENA0

Disable Interleaved 2 of 5



If the scanner fails to identify Interleaved 2 of 5 barcodes, you may first try this solution by scanning the **Enter Setup** barcode and then **Enable Interleaved 2 of 5** barcode.



@SETUPE0

**** Exit Setup**



@SETUPE1
Enter Setup

Set Length Range for Interleaved 2 of 5

The scanner can be configured to only decode Interleaved 2 of 5 barcodes with lengths that fall between (inclusive) the minimum and maximum lengths. To accomplish it, you need to set the minimum and maximum lengths.



@I25MIN
Set the Minimum Length (Default: 6)



@I25MAX
Set the Maximum Length (Default: 80)



If minimum length is set to be greater than maximum length, the scanner only decodes Interleaved 2 of 5 barcodes with either the minimum or maximum length. If minimum length is same as maximum length, only Interleaved 2 of 5 barcodes with that length are to be decoded.



Set the scanner to decode Interleaved 2 of 5 barcodes containing between 8 and 12 characters:

1. Scan the **Enter Setup** barcode.
2. Scan the **Set the Minimum Length** barcode.
3. Scan the numeric barcode “8” from the “Digit Barcodes” section in Appendix.
4. Scan the **Save** barcode from the “Save/Cancel Barcodes” section in Appendix.
5. Scan the **Set the Maximum Length** barcode.
6. Scan the numeric barcodes “1” and “2” from the “Digit Barcodes” section in Appendix.
7. Scan the **Save** barcode from the “Save/Cancel Barcodes” section in Appendix.
8. Scan the **Exit Setup** barcode.



@SETUPE0
**** Exit Setup**



@SETUPE1

Enter Setup

Check Character Verification

A check character is optional for Interleaved 2 of 5 and can be added as the last character. It is a calculated value used to verify the integrity of the data.

- ◇ **Disable:** The scanner transmits Interleaved 2 of 5 barcodes as is.
- ◇ **Do Not Transmit Check Character After Verification:** The scanner checks the integrity of all Interleaved 2 of 5 barcodes to verify that the data complies with the check character algorithm. Barcodes passing the check will be transmitted except the last digit, whereas those failing it will not be transmitted.
- ◇ **Transmit Check Character After Verification:** The scanner checks the integrity of all Interleaved 2 of 5 barcodes to verify that the data complies with the check character algorithm. Barcodes passing the check will be transmitted, whereas those failing it will not be transmitted.

Since Interleaved 2 of 5 must always have an even number of digits, a zero may need to be added as the first digit when the check character is added. The check character is automatically generated when making Interleaved 2 of 5 barcodes.



@I25CHK0

Disable



@I25CHK1

**** Do Not Transmit Check Character After Verification**



@I25CHK2

Transmit Check Character After Verification



If the **Do Not Transmit Check Character After Verification** option is enabled, Interleaved 2 of 5 barcodes with a length that is less than the configured minimum length after having the check character excluded will not be decoded. (For example, when the **Do Not Transmit Check Character After Verification** option is enabled and the minimum length is set to 4, Interleaved 2 of 5 barcodes with a total length of 4 characters including the check character cannot be read.)



@SETUPE0

**** Exit Setup**



@SETUPE1

Enter Setup

Febraban

Disable/Enable Febraban



@I25FBB0

Disable Febraban



@I25FBB2

Enable Febraban, Expand



@I25FBB1

** Enable Febraban, Do Not Expand

Transmit Delay per Character

Transmit Delay per Character applies to both Expanded and Unexpanded Febraban. This feature is available only when USB HID Keyboard is enabled.



@FEBSNO

** Disable Transmit Delay per Character



@FEBSN1

Enable Transmit Delay per Character



@SETUPE0

** Exit Setup



@SETUPE1

Enter Setup

You may select an appropriate delay value from the options below as per your actual needs.



@FEBSDT0

0ms



@FEBSDT5

5ms



@FEBSDT10

10ms



@FEBSDT15

15ms



@FEBSDT20

20ms



@FEBSDT25

25ms



@FEBSDT30

30ms



@FEBSDT35

35ms



@SETUPE1

Enter Setup



@FEBSDT40

40ms



@FEBSDT45

45ms

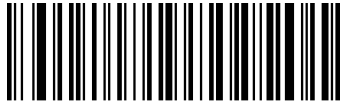

@FEBSDT50

50ms



@FEBSDT55

55ms



@FEBSDT60

60ms



@FEBSDT65

65ms

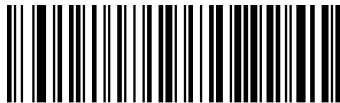

@FEBSDT70

**** 70ms**



@FEBSDT75

75ms



@SETUPE0

**** Exit Setup**



@SETUPE1

Enter Setup

Transmit Delay per 12 Characters

Transmit Delay per 12 Characters applies to Expanded Febraban only. This feature is available only when USB HID Keyboard is enabled.



@FEBMENO

**** Disable Transmit Delay per 12 Characters**



@FEBMEN1

Enable Transmit Delay per 12 Characters

You may select an appropriate delay value from the options below as per your actual needs.



@FEBMDT0

0ms



@FEBMDT1

300ms



@FEBMDT2

400ms



@SETUPE1

Enter Setup

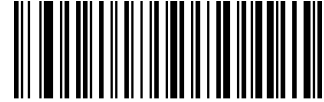

@FEBMDT3

**** 500ms**



@FEBMDT4

600ms



@FEBMDT5

700ms



@FEBMDT6

800ms



@FEBMDT7

900ms



@SETUPE0

**** Exit Setup**



@SETUPE1

Enter Setup

ITF-14

ITF-14 is a special kind of Interleaved 2 of 5 with a length of 14 characters and the last character as the check character.

ITF-14 priority principle: For the Interleaved 2 of 5 barcodes with a length of 14 characters and the last character as the check character, the ITF-14 configurations shall take precedence over the Interleaved 2 of 5 settings.

Restore Factory Defaults



@I14DEF

Restore the Factory Defaults of ITF-14

Enable/Disable ITF-14



@I14ENA0

** Disable ITF-14



@I14ENA1

Enable ITF-14 But Do Not Transmit Check Character



@I14ENA2

Enable ITF-14 and Transmit Check Character



An example of the ITF-14 priority principle: when ITF-14 is enabled and Interleaved 2 of 5 is disabled, the scanner only decodes Interleaved 2 of 5 barcodes with a length of 14 characters and the last character as the check character.



@SETUPE0

** Exit Setup



@SETUPE1

Enter Setup

ITF-6

ITF-6 is a special kind of Interleaved 2 of 5 with a length of 6 characters and the last character as the check character.

ITF-6 priority principle: For the Interleaved 2 of 5 barcodes with a length of 6 characters and the last character as the check character, the ITF-6 configurations shall take precedence over the Interleaved 2 of 5 settings.

Restore Factory Defaults



@IT6DEF

Restore the Factory Defaults of ITF-6

Enable/Disable ITF-6



@IT6ENA0

**** Disable ITF-6**



@IT6ENA1

Enable ITF-6 But Do Not Transmit Check Character



@IT6ENA2

Enable ITF-6 and Transmit Check Character



An example of the ITF-6 priority principle: when ITF-6 is enabled and Interleaved 2 of 5 is disabled, the scanner only decodes Interleaved 2 of 5 barcodes with a length of 6 characters and the last character as the check character.



@SETUPE0

**** Exit Setup**



@SETUPE1
Enter Setup

Matrix 2 of 5

Restore Factory Defaults



@M25DEF

Restore the Factory Defaults of Matrix 2 of 5

Enable/Disable Matrix 2 of 5



@M25ENA1

**** Enable Matrix 2 of 5**



@M25ENA0

Disable Matrix 2 of 5



If the scanner fails to identify Matrix 2 of 5 barcodes, you may first try this solution by scanning the **Enter Setup** barcode and then **Enable Matrix 2 of 5** barcode.



@SETUPE0

**** Exit Setup**



@SETUPE1
Enter Setup

Set Length Range for Matrix 2 of 5

The scanner can be configured to only decode Matrix 2 of 5 barcodes with lengths that fall between (inclusive) the minimum and maximum lengths. To accomplish it, you need to set the minimum and maximum lengths.



@M25MIN

Set the Minimum Length (Default: 4)



@M25MAX

Set the Maximum Length (Default: 80)



If minimum length is set to be greater than maximum length, the scanner only decodes Matrix 2 of 5 barcodes with either the minimum or maximum length. If minimum length is same as maximum length, only Matrix 2 of 5 barcodes with that length are to be decoded.



Set the scanner to decode Matrix 2 of 5 barcodes containing between 8 and 12 characters:

1. Scan the **Enter Setup** barcode.
2. Scan the **Set the Minimum Length** barcode.
3. Scan the numeric barcode “8” from the “Digit Barcodes” section in Appendix.
4. Scan the **Save** barcode from the “Save/Cancel Barcodes” section in Appendix.
5. Scan the **Set the Maximum Length** barcode.
6. Scan the numeric barcodes “1” and “2” from the “Digit Barcodes” section in Appendix.
7. Scan the **Save** barcode from the “Save/Cancel Barcodes” section in Appendix.
8. Scan the **Exit Setup** barcode.



@SETUPE0
**** Exit Setup**



@SETUPE1

Enter Setup

Check Character Verification

A check character is optional for Matrix 2 of 5 and can be added as the last character. It is a calculated value used to verify the integrity of the data.

- ◇ **Disable:** The scanner transmits Matrix 2 of 5 barcodes as is.
- ◇ **Do Not Transmit Check Character After Verification:** The scanner checks the integrity of all Matrix 2 of 5 barcodes to verify that the data complies with the check character algorithm. Barcodes passing the check will be transmitted except the last digit, whereas those failing it will not be transmitted.
- ◇ **Transmit Check Character After Verification:** The scanner checks the integrity of all Matrix 2 of 5 barcodes to verify that the data complies with the check character algorithm. Barcodes passing the check will be transmitted, whereas those failing it will not be transmitted.

Since Matrix 2 of 5 must always have an even number of digits, a zero may need to be added as the first digit when the check character is added. The check character is automatically generated when making Matrix 2 of 5 barcodes.



@M25CHK0

** Disable



@M25CHK1

Do Not Transmit Check Character After Verification



@M25CHK2

Transmit Check Character After Verification



If the **Do Not Transmit Check Character After Verification** option is enabled, Matrix 2 of 5 barcodes with a length that is less than the configured minimum length after having the check character excluded will not be decoded. (For example, when the **Do Not Transmit Check Character After Verification** option is enabled and the minimum length is set to 4, Matrix 2 of 5 barcodes with a total length of 4 characters including the check character cannot be read.)



@SETUPE0

** Exit Setup



@SETUPE1

Enter Setup

Code 39

Restore Factory Defaults



@C39DEF

Restore the Factory Defaults of Code 39

Enable/Disable Code 39



@C39ENA1

**** Enable Code 39**



@C39ENA0

Disable Code 39



If the scanner fails to identify Code 39 barcodes, you may first try this solution by scanning the **Enter Setup** barcode and then **Enable Code 39** barcode.



@SETUPE0

**** Exit Setup**



@SETUPE1

Enter Setup

Set Length Range for Code 39

The scanner can be configured to only decode Code 39 barcodes with lengths that fall between (inclusive) the minimum and maximum lengths. To accomplish it, you need to set the minimum and maximum lengths.



@C39MIN

Set the Minimum Length (Default: 1)



@C39MAX

Set the Maximum Length (Default: 48)



If minimum length is set to be greater than maximum length, the scanner only decodes Code 39 barcodes with either the minimum or maximum length. If minimum length is same as maximum length, only Code 39 barcodes with that length are to be decoded.

Example

Set the scanner to decode Code 39 barcodes containing between 8 and 12 characters:

1. Scan the **Enter Setup** barcode.
2. Scan the **Set the Minimum Length** barcode.
3. Scan the numeric barcode “8” from the “Digit Barcodes” section in Appendix.
4. Scan the **Save** barcode from the “Save/Cancel Barcodes” section in Appendix.
5. Scan the **Set the Maximum Length** barcode.
6. Scan the numeric barcodes “1” and “2” from the “Digit Barcodes” section in Appendix.
7. Scan the **Save** barcode from the “Save/Cancel Barcodes” section in Appendix.
8. Scan the **Exit Setup** barcode.



@SETUPE0

** Exit Setup



@SETUPE1
Enter Setup

Check Character Verification

A check character is optional for Code 39 and can be added as the last character. It is a calculated value used to verify the integrity of the data.

- ◇ **Disable:** The scanner transmits Code 39 barcodes as is.
- ◇ **Do Not Transmit Check Character After Verification:** The scanner checks the integrity of all Code 39 barcodes to verify that the data complies with the check character algorithm. Barcodes passing the check will be transmitted except the last digit, whereas those failing it will not be transmitted.
- ◇ **Transmit Check Character After Verification:** The scanner checks the integrity of all Code 39 barcodes to verify that the data complies with the check character algorithm. Barcodes passing the check will be transmitted, whereas those failing it will not be transmitted.



@C39CHK0
** Disable



Do Not Transmit Check Character After Verification



Transmit Check Character After Verification



If the **Do Not Transmit Check Character After Verification** option is enabled, Code 39 barcodes with a length that is less than the configured minimum length after having the check character excluded will not be decoded. (For example, when the **Do Not Transmit Check Character After Verification** option is enabled and the minimum length is set to 4, Code 39 barcodes with a total length of 4 characters including the check character cannot be read.)



@SETUPE0
** Exit Setup



@SETUPE1

Enter Setup

Transmit Start/Stop Character

Code 39 uses an asterisk (*) for both the start and the stop characters. You can choose whether or not to transmit the start/stop characters by scanning the appropriate barcode below.



@C39TSC0

**** Do Not Transmit Start/Stop Character**



@C39TSC1

Transmit Start/Stop Character

Enable/Disable Code 39 Full ASCII

The scanner can be configured to identify all ASCII characters by scanning the appropriate barcode below.



@C39ASC0

**** Disable Code 39 Full ASCII**



@C39ASC1

Enable Code 39 Full ASCII



@SETUPE0

**** Exit Setup**



@SETUPE1

Enter Setup

Enable/Disable Code 32 (Italian Pharma Code)

Code 32 is a variant of Code 39 used by the Italian pharmaceutical industry. Scan the appropriate barcode below to enable or disable Code 32. Code 39 must be enabled and Code 39 check character verification must be disabled for this parameter to function.



@C39E320

**** Disable Code 32**



@C39E321

Enable Code 32

Code 32 Prefix

You may scan the appropriate barcode below to enable or disable adding the prefix character "A" to all Code 32 barcodes. Code 32 must be enabled for this parameter to function.



@C39S320

**** Disable Code 32 Prefix**



@C39S321

Enable Code 32 Prefix



@SETUPE0

**** Exit Setup**



@SETUPE1

Enter Setup

Transmit Code 32 Start/Stop Character

Code 32 must be enabled for this parameter to function.



@C39T320

**** Do Not Transmit Code 32 Start/Stop Character**



@C39T321

Transmit Code 32 Start/Stop Character

Transmit Code 32 Check Character

Code 32 must be enabled for this parameter to function.



@C39C320

**** Do Not Transmit Code 32 Check Character**



@C39C321

Transmit Code 32 Check Character



@SETUPE0

**** Exit Setup**



@SETUPE1

Enter Setup

Codabar

Restore Factory Defaults



@CBADEF

Restore the Factory Defaults of Codabar

Enable/Disable Codabar



@CBAENA1

**** Enable Codabar**



@CBAENA0

Disable Codabar



If the scanner fails to identify Codabar barcodes, you may first try this solution by scanning the **Enter Setup** barcode and then **Enable Codabar** barcode.



@SETUPE0

**** Exit Setup**



@SETUPE1

Enter Setup

Set Length Range for Codabar

The scanner can be configured to only decode Codabar barcodes with lengths that fall between (inclusive) the minimum and maximum lengths. To accomplish it, you need to set the minimum and maximum lengths.



@CBAMIN

Set the Minimum Length (Default: 2)



@CBAMAX

Set the Maximum Length (Default: 60)



If minimum length is set to be greater than maximum length, the scanner only decodes Codabar barcodes with either the minimum or maximum length. If minimum length is same as maximum length, only Codabar barcodes with that length are to be decoded.



Set the scanner to decode Codabar barcodes containing between 8 and 12 characters:

1. Scan the **Enter Setup** barcode.
2. Scan the **Set the Minimum Length** barcode.
3. Scan the numeric barcode “8” from the “Digit Barcodes” section in Appendix.
4. Scan the **Save** barcode from the “Save/Cancel Barcodes” section in Appendix.
5. Scan the **Set the Maximum Length** barcode.
6. Scan the numeric barcodes “1” and “2” from the “Digit Barcodes” section in Appendix.
7. Scan the **Save** barcode from the “Save/Cancel Barcodes” section in Appendix.
8. Scan the **Exit Setup** barcode.



@SETUPE0

**** Exit Setup**



@SETUPE1
Enter Setup

Check Character Verification

A check character is optional for Codabar and can be added as the last character. It is a calculated value used to verify the integrity of the data.

- ◇ **Disable:** The scanner transmits Codabar barcodes as is.
- ◇ **Do Not Transmit Check Character After Verification:** The scanner checks the integrity of all Codabar barcodes to verify that the data complies with the check character algorithm. Barcodes passing the check will be transmitted except the last digit, whereas those failing it will not be transmitted.
- ◇ **Transmit Check Character After Verification:** The scanner checks the integrity of all Codabar barcodes to verify that the data complies with the check character algorithm. Barcodes passing the check will be transmitted, whereas those failing it will not be transmitted.

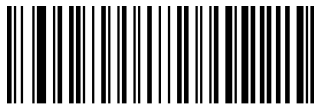

@CBACHK0
** Disable



@CBACHK1

Do Not Transmit Check Character After Verification

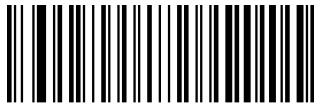

@CBACHK2

Transmit Check Character After Verification



If the **Do Not Transmit Check Character After Verification** option is enabled, Codabar barcodes with a length that is less than the configured minimum length after having the check character excluded will not be decoded. (For example, when the **Do Not Transmit Check Character After Verification** option is enabled and the minimum length is set to 4, Codabar barcodes with a total length of 4 characters including the check character cannot be read.)



@SETUPE0
** Exit Setup



@SETUPE1

Enter Setup

Start/Stop Character

You can set the start/stop characters and choose whether or not to transmit the start/stop characters by scanning the appropriate barcode below.



@CBATSC0

**** Do Not Transmit Start/Stop Character**



@CBATSC1

Transmit Start/Stop Character



@CBASCF0

**** ABCD/ABCD as the Start/Stop Character**



@CBASCF1

ABCD/TN*E as the Start/Stop Character



@CBASCF2

abcd/abcd as the Start/Stop Character



@CBASCF3

abcd/tn*e as the Start/Stop Character



@SETUPE0

**** Exit Setup**



@SETUPE1

Enter Setup

Code 93

Restore Factory Defaults



@C93DEF

Restore the Factory Defaults of Code 93

Enable/Disable Code 93



@C93ENA1

**** Enable Code 93**



@C93ENA0

Disable Code 93



If the scanner fails to identify Code 93 barcodes, you may first try this solution by scanning the **Enter Setup** barcode and then **Enable Code 93** barcode.



@SETUPE0

**** Exit Setup**



@SETUPE1

Enter Setup

Set Length Range for Code 93

The scanner can be configured to only decode Code 93 barcodes with lengths that fall between (inclusive) the minimum and maximum lengths. To accomplish it, you need to set the minimum and maximum lengths.



@C93MIN

Set the Minimum Length (Default: 1)



@C93MAX

Set the Maximum Length (Default: 48)



If minimum length is set to be greater than maximum length, the scanner only decodes Code 93 barcodes with either the minimum or maximum length. If minimum length is same as maximum length, only Code 93 barcodes with that length are to be decoded.

Set the scanner to decode Code 93 barcodes containing between 8 and 12 characters:

E
example

1. Scan the **Enter Setup** barcode.
2. Scan the **Set the Minimum Length** barcode.
3. Scan the numeric barcode “8” from the “Digit Barcodes” section in Appendix.
4. Scan the **Save** barcode from the “Save/Cancel Barcodes” section in Appendix.
5. Scan the **Set the Maximum Length** barcode.
6. Scan the numeric barcodes “1” and “2” from the “Digit Barcodes” section in Appendix.
7. Scan the **Save** barcode from the “Save/Cancel Barcodes” section in Appendix.
8. Scan the **Exit Setup** barcode.



@SETUPE0

** Exit Setup



@SETUPE1

Enter Setup

Check Character Verification

Check characters are optional for Code 93 and can be added as the last two characters, which are calculated values used to verify the integrity of the data.

- ◇ **Disable:** The scanner transmits Code 93 barcodes as is.
- ◇ **Do Not Transmit Check Character After Verification:** The scanner checks the integrity of all Code 93 barcodes to verify that the data complies with the check character algorithm. Barcodes passing the checks will be transmitted except the last two digits, whereas those failing them will not be transmitted.
- ◇ **Transmit Check Character After Verification:** The scanner checks the integrity of all Code 93 barcodes to verify that the data complies with the check character algorithm. Barcodes passing the checks will be transmitted, whereas those failing them will not be transmitted.



@C93CHK0

Disable



@C93CHK1

**** Do Not Transmit Check Character After Verification**



@C93CHK2

Transmit Check Character After Verification



If the **Do Not Transmit Check Character After Verification** option is enabled, Code 93 barcodes with a length that is less than the configured minimum length after having the two check characters excluded will not be decoded. (For example, when the **Do Not Transmit Check Character After Verification** option is enabled and the minimum length is set to 4, Code 93 barcodes with a total length of 4 characters including the two check characters cannot be read.)



@SETUPE0

**** Exit Setup**



@SETUPE1

Enter Setup

China Post 25

Restore Factory Defaults



@CHPDEF

Restore the Factory Defaults of China Post 25

Enable/Disable China Post 25



@CHPENA1

Enable China Post 25



@CHPENAO

**** Disable China Post 25**



If the scanner fails to identify China Post 25 barcodes, you may first try this solution by scanning the **Enter Setup** barcode and then **Enable China Post 25** barcode.



@SETUPE0

**** Exit Setup**



@SETUPE1
Enter Setup

Set Length Range for China Post 25

The scanner can be configured to only decode China Post 25 barcodes with lengths that fall between (inclusive) the minimum and maximum lengths. To accomplish it, you need to set the minimum and maximum lengths.



@CHPMIN

Set the Minimum Length (Default: 1)



@CHPMAX

Set the Maximum Length (Default: 48)



If minimum length is set to be greater than maximum length, the scanner only decodes China Post 25 barcodes with either the minimum or maximum length. If minimum length is same as maximum length, only China Post 25 barcodes with that length are to be decoded.

E
xample

Set the scanner to decode China Post 25 barcodes containing between 8 and 12 characters:

1. Scan the **Enter Setup** barcode.
2. Scan the **Set the Minimum Length** barcode.
3. Scan the numeric barcode “8” from the “Digit Barcodes” section in Appendix.
4. Scan the **Save** barcode from the “Save/Cancel Barcodes” section in Appendix.
5. Scan the **Set the Maximum Length** barcode.
6. Scan the numeric barcodes “1” and “2” from the “Digit Barcodes” section in Appendix.
7. Scan the **Save** barcode from the “Save/Cancel Barcodes” section in Appendix.
8. Scan the **Exit Setup** barcode.



@SETUPE0
**** Exit Setup**



@SETUPE1

Enter Setup

Check Character Verification

A check character is optional for China Post 25 and can be added as the last character. It is a calculated value used to verify the integrity of the data.

- ◇ **Disable:** The scanner transmits China Post 25 barcodes as is.
- ◇ **Do Not Transmit Check Character After Verification:** The scanner checks the integrity of all China Post 25 barcodes to verify that the data complies with the check character algorithm. Barcodes passing the check will be transmitted except the last digit, whereas those failing it will not be transmitted.
- ◇ **Transmit Check Character After Verification:** The scanner checks the integrity of all China Post 25 barcodes to verify that the data complies with the check character algorithm. Barcodes passing the check will be transmitted, whereas those failing it will not be transmitted.



@CHPCHK0

** Disable



@CHPCHK1

Do Not Transmit Check Character After Verification



@CHPCHK2

Transmit Check Character After Verification



If the **Do Not Transmit Check Character After Verification** option is enabled, China Post 25 barcodes with a length that is less than the configured minimum length after having the check character excluded will not be decoded. (For example, when the **Do Not Transmit Check Character After Verification** option is enabled and the minimum length is set to 4, China Post 25 barcodes with a total length of 4 characters including the check character cannot be read.)



@SETUPE0

** Exit Setup



@SETUPE1

Enter Setup

GS1-128 (UCC/EAN-128)

Restore Factory Defaults



@GS1DEF

Restore the Factory Defaults of GS1-128

Enable/Disable GS1-128



@GS1ENA1

**** Enable GS1-128**



@GS1ENA0

Disable GS1-128



If the scanner fails to identify GS1-128 barcodes, you may first try this solution by scanning the **EnterSetup** barcode and then **Enable GS1-128** barcode.



@SETUPE0

**** Exit Setup**



@SETUPE1

Enter Setup

Set Length Range for GS1-128

The scanner can be configured to only decode GS1-128 barcodes with lengths that fall between (inclusive) the minimum and maximum lengths. To accomplish it, you need to set the minimum and maximum lengths.



@GS1MIN

Set the Minimum Length (Default: 1)

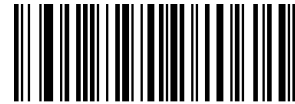

@GS1MAX

Set the Maximum Length (Default: 48)



If minimum length is set to be greater than maximum length, the scanner only decodes GS1-128 barcodes with either the minimum or maximum length. If minimum length is same as maximum length, only GS1-128 barcodes with that length are to be decoded.

E *sample*

Set the scanner to decode GS1-128 barcodes containing between 8 and 12 characters:

1. Scan the **Enter Setup** barcode.
2. Scan the **Set the Minimum Length** barcode.
3. Scan the numeric barcode “8” from the “Digit Barcodes” section in Appendix.
4. Scan the **Save** barcode from the “Save/Cancel Barcodes” section in Appendix.
5. Scan the **Set the Maximum Length** barcode.
6. Scan the numeric barcodes “1” and “2” from the “Digit Barcodes” section in Appendix.
7. Scan the **Save** barcode from the “Save/Cancel Barcodes” section in Appendix.
8. Scan the **Exit Setup** barcode.



@SETUPE0

**** Exit Setup**



@SETUPE1

Enter Setup

GS1 Databar (RSS)

Restore Factory Defaults



@RSSDEF

Restore the Factory Defaults of GS1 Databar

Enable/Disable GS1 Databar



@RSSENA1

** Enable GS1 Databar

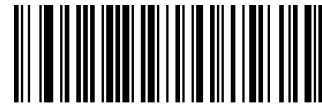

@RSSENA0

Disable GS1 Databar



If the scanner fails to identify GS1 Databar barcodes, you may first try this solution by scanning the **Enter Setup** barcode and then **Enable GS1 Databar** barcode.

Transmit Application Identifier "01"



@RSSTA1

** Transmit Application Identifier "01"



@RSSTA0

Do Not Transmit Application Identifier "01"



@SETUPE0

** Exit Setup



@SETUPE1

Enter Setup

GS1 Composite (EAN-UCC Composite)

Restore Factory Defaults



@CPTDEF

Restore the Factory Defaults of GS1 Composite

Enable/Disable GS1 Composite



@CPTENA1

Enable GS1 Composite



@CPTENA0

** Disable GS1 Composite



If the scanner fails to identify GS1 Composite barcodes, you may first try this solution by scanning the **Enter Setup** barcode and then **Enable GS1 Composite** barcode.

Enable/Disable UPC/EAN Composite

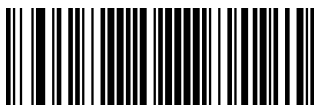

@CPTUPC1

Enable UPC/EAN Composite



@CPTUPC0

** Disable UPC/EAN Composite



@SETUPE0

** Exit Setup



@SETUPE1

Enter Setup

Code 11

Restore Factory Defaults



@C11DEF

Restore the Factory Defaults of Code 11

Enable/Disable Code 11



@C11ENA1

**** Enable Code 11**



@C11ENA0

Disable Code 11



If the scanner fails to identify Code 11 barcodes, you may first try this solution by scanning the **Enter Setup** barcode and then **Enable Code 11** barcode.



@SETUPE0

**** Exit Setup**



@SETUPE1

Enter Setup

Set Length Range for Code 11

The scanner can be configured to only decode Code 11 barcodes with lengths that fall between (inclusive) the minimum and maximum lengths. To accomplish it, you need to set the minimum and maximum lengths.



@C11MIN

Set the Minimum Length (Default: 4)



@C11MAX

Set the Maximum Length (Default: 48)



If minimum length is set to be greater than maximum length, the scanner only decodes Code 11 barcodes with either the minimum or maximum length. If minimum length is same as maximum length, only Code 11 barcodes with that length are to be decoded.



Set the scanner to decode Code 11 barcodes containing between 8 and 12 characters:

1. Scan the **Enter Setup** barcode.
2. Scan the **Set the Minimum Length** barcode.
3. Scan the numeric barcode “8” from the “Digit Barcodes” section in Appendix.
4. Scan the **Save** barcode from the “Save/Cancel Barcodes” section in Appendix.
5. Scan the **Set the Maximum Length** barcode.
6. Scan the numeric barcodes “1” and “2” from the “Digit Barcodes” section in Appendix.
7. Scan the **Save** barcode from the “Save/Cancel Barcodes” section in Appendix.
8. Scan the **Exit Setup** barcode.



@SETUPE0

** Exit Setup



@SETUPE1
Enter Setup

Check Character Verification

Check characters are optional for Code 11 and can be added as the last one or two characters, which are calculated values used to verify the integrity of the data.

If the **Disable** option is enabled, the scanner transmits Code 11 barcodes as is.



@C11CHK0
Disable



@C11CHK1
**** One Check Character, MOD11**



@C11CHK2
Two Check Characters, MOD11/MOD11



@C11CHK3
Two Check Characters, MOD11/MOD9



@C11CHK4
One Check Character, MOD11 (Len<=10)
Two Check Characters, MOD11/MOD11(Len>10)



@C11CHK5
One Check Character, MOD11 (Len<=10)
Two Check Characters, MOD11/MOD9 (Len>10)



@SETUPE0
**** Exit Setup**



@SETUPE1

Enter Setup

Transmit Check Character



@C11TCK0

Do Not Transmit Code 11 Check Character



@C11TCK1

** Transmit Code 11 Check Character



If you select a check character algorithm and the **Do Not Transmit Check Character** option, Code 11 barcodes with a length that is less than the configured minimum length after having the check character(s) excluded will not be decoded. (For example, when the **One Check Character, MOD11** and **Do Not Transmit Check Character** options are enabled and the minimum length is set to 4, Code 11 barcodes with a total length of 4 characters including the check character cannot be read.)



@SETUPE0

** Exit Setup



@SETUPE1

Enter Setup

ISBN

Restore Factory Defaults



@ISBDEF

Restore the Factory Defaults of ISBN

Enable/Disable ISBN



@ISBENA1

Enable ISBN



@ISBENA0

**** Disable ISBN**



If the scanner fails to identify ISBN barcodes, you may first try this solution by scanning the **Enter Setup** barcode and then **Enable ISBN** barcode.



@SETUPE0

**** Exit Setup**



@SETUPE1

Enter Setup

Set ISBN Format



@ISBT101

**** ISBN-10**



@ISBT100

ISBN-13



@SETUPE0

**** Exit Setup**



@SETUPE1

Enter Setup

ISSN

Restore Factory Defaults



@ISSDEF

Restore the Factory Defaults of ISSN

Enable/Disable ISSN



@ISSENA1

Enable ISSN



@ISSENA0

**** Disable ISSN**



If the scanner fails to identify ISSN barcodes, you may first try this solution by scanning the **Enter Setup** barcode and then **Enable ISSN** barcode.



@SETUPE0

**** Exit Setup**



@SETUPE1
Enter Setup

Industrial 25

Restore Factory Defaults



@L25DEF

Restore the Factory Defaults of Industrial 25

Enable/Disable Industrial 25



@L25ENA1

**** Enable Industrial 25**



@L25ENA0

Disable Industrial 25



If the scanner fails to identify Industrial 25 barcodes, you may first try this solution by scanning the **Enter Setup** barcode and then **Enable Industrial 25** barcode.



@SETUPE0

**** Exit Setup**



@SETUPE1
Enter Setup

Set Length Range for Industrial 25

The scanner can be configured to only decode Industrial 25 barcodes with lengths that fall between (inclusive) the minimum and maximum lengths. To accomplish it, you need to set the minimum and maximum lengths.



@L25MIN
Set the Minimum Length (Default: 6)



@L25MAX
Set the Maximum Length (Default: 48)



If minimum length is set to be greater than maximum length, the scanner only decodes Industrial 25 barcodes with either the minimum or maximum length. If minimum length is same as maximum length, only Industrial 25 barcodes with that length are to be decoded.

E
sample

Set the scanner to decode Industrial 25 barcodes containing between 8 and 12 characters:

1. Scan the **Enter Setup** barcode.
2. Scan the **Set the Minimum Length** barcode.
3. Scan the numeric barcode “8” from the “Digit Barcodes” section in Appendix.
4. Scan the **Save** barcode from the “Save/Cancel Barcodes” section in Appendix.
5. Scan the **Set the Maximum Length** barcode.
6. Scan the numeric barcodes “1” and “2” from the “Digit Barcodes” section in Appendix.
7. Scan the **Save** barcode from the “Save/Cancel Barcodes” section in Appendix.
8. Scan the **Exit Setup** barcode.



@SETUPE0
**** Exit Setup**



@SETUPE1

Enter Setup

Check Character Verification

A check character is optional for Industrial 25 and can be added as the last character. It is a calculated value used to verify the integrity of the data.

- ◇ **Disable:** The scanner transmits Industrial 25 barcodes as is.
- ◇ **Do Not Transmit Check Character After Verification:** The scanner checks the integrity of all Industrial 25 barcodes to verify that the data complies with the check character algorithm. Barcodes passing the check will be transmitted except the last digit, whereas those failing it will not be transmitted.
- ◇ **Transmit Check Character After Verification:** The scanner checks the integrity of all Industrial 25 barcodes to verify that the data complies with the check character algorithm. Barcodes passing the check will be transmitted, whereas those failing it will not be transmitted.



@L25CHK0

** Disable



@L25CHK1

Do Not Transmit Check Character After Verification



@L25CHK2

Transmit Check Character After Verification



If the **Do Not Transmit Check Character After Verification** option is enabled, Industrial 25 barcodes with a length that is less than the configured minimum length after having the check character excluded will not be decoded. (For example, when the **Do Not Transmit Check Character After Verification** option is enabled and the minimum length is set to 4, Industrial 25 barcodes with a total length of 4 characters including the check character cannot be read.)



@SETUPE0

** Exit Setup



@SETUPE1

Enter Setup

Standard 25

Restore Factory Defaults



@S25DEF

Restore the Factory Defaults of Standard 25

Enable/Disable Standard 25



@S25ENA1

**** Enable Standard 25**



@S25ENA0

Disable Standard 25



If the scanner fails to identify Standard 25 barcodes, you may first try this solution by scanning the **Enter Setup** barcode and then **Enable Standard 25** barcode.



@SETUPE0

**** Exit Setup**



@SETUPE1

Enter Setup

Set Length Range for Standard 25

The scanner can be configured to only decode Standard 25 barcodes with lengths that fall between (inclusive) the minimum and maximum lengths. To accomplish it, you need to set the minimum and maximum lengths.



@S25MIN

Set the Minimum Length (Default: 6)



@S25MAX

Set the Maximum Length (Default: 48)



If minimum length is set to be greater than maximum length, the scanner only decodes Standard 25 barcodes with either the minimum or maximum length. If minimum length is same as maximum length, only Standard 25 barcodes with that length are to be decoded.



Set the scanner to decode Standard 25 barcodes containing between 8 and 12 characters:

1. Scan the **Enter Setup** barcode.
2. Scan the **Set the Minimum Length** barcode.
3. Scan the numeric barcode “8” from the “Digit Barcodes” section in Appendix.
4. Scan the **Save** barcode from the “Save/Cancel Barcodes” section in Appendix.
5. Scan the **Set the Maximum Length** barcode.
6. Scan the numeric barcodes “1” and “2” from the “Digit Barcodes” section in Appendix.
7. Scan the **Save** barcode from the “Save/Cancel Barcodes” section in Appendix.
8. Scan the **Exit Setup** barcode.



@SETUPE0

**** Exit Setup**



@SETUPE1
Enter Setup

Check Character Verification

A check character is optional for Standard 25 and can be added as the last character. It is a calculated value used to verify the integrity of the data.

- ◇ **Disable:** The scanner transmits Standard 25 barcodes as is.
- ◇ **Do Not Transmit Check Character After Verification:** The scanner checks the integrity of all Standard 25 barcodes to verify that the data complies with the check character algorithm. Barcodes passing the check will be transmitted except the last digit, whereas those failing it will not be transmitted.
- ◇ **Transmit Check Character After Verification:** The scanner checks the integrity of all Standard 25 barcodes to verify that the data complies with the check character algorithm. Barcodes passing the check will be transmitted, whereas those failing it will not be transmitted.



@S25CHK0
** Disable



@S25CHK1

Do Not Transmit Check Character After Verification



@S25CHK2

Transmit Check Character After Verification



If the **Do Not Transmit Check Character After Verification** option is enabled, Standard 25 barcodes with a length that is less than the configured minimum length after having the check character excluded will not be decoded. (For example, when the **Do Not Transmit Check Character After Verification** option is enabled and the minimum length is set to 4, Standard 25 barcodes with a total length of 4 characters including the check character cannot be read.)



@SETUPE0
** Exit Setup



@SETUPE1

Enter Setup

Plessey

Restore Factory Defaults



@PLYDEF

Restore the Factory Defaults of Plessey

Enable/Disable Plessey



@PLYENA1

Enable Plessey



@PLYENA0

**** Disable Plessey**



If the scanner fails to identify Plessey barcodes, you may first try this solution by scanning the **Enter Setup** barcode and then **Enable Plessey** barcode.



@SETUPE0

**** Exit Setup**



@SETUPE1
Enter Setup

Set Length Range for Plessey

The scanner can be configured to only decode Plessey barcodes with lengths that fall between (inclusive) the minimum and maximum lengths. To accomplish it, you need to set the minimum and maximum lengths.



Set the Minimum Length (Default: 48)



Set the Maximum Length (Default: 4)



If minimum length is set to be greater than maximum length, the scanner only decodes Plessey barcodes with either the minimum or maximum length. If minimum length is same as maximum length, only Plessey barcodes with that length are to be decoded.

E *xample*

Set the scanner to decode Plessey barcodes containing between 8 and 12 characters:

1. Scan the **Enter Setup** barcode.
2. Scan the **Set the Minimum Length** barcode.
3. Scan the numeric barcode “8” from the “Digit Barcodes” section in Appendix.
4. Scan the **Save** barcode from the “Save/Cancel Barcodes” section in Appendix.
5. Scan the **Set the Maximum Length** barcode.
6. Scan the numeric barcodes “1” and “2” from the “Digit Barcodes” section in Appendix.
7. Scan the **Save** barcode from the “Save/Cancel Barcodes” section in Appendix.
8. Scan the **Exit Setup** barcode.



@SETUPE0
**** Exit Setup**



@SETUPE1

Enter Setup

Check Character Verification

Check characters are optional for Plessey and can be added as the last two characters, which are calculated values used to verify the integrity of the data.

- ◇ **Disable:** The scanner transmits Plessey barcodes as is.
- ◇ **Do Not Transmit Check Character After Verification:** The scanner checks the integrity of all Plessey barcodes to verify that the data complies with the check character algorithm. Barcodes passing the checks will be transmitted except the last two digits, whereas those failing them will not be transmitted.
- ◇ **Transmit Check Character After Verification:** The scanner checks the integrity of all Plessey barcodes to verify that the data complies with the check character algorithm. Barcodes passing the checks will be transmitted, whereas those failing them will not be transmitted.



@PLYCHK0

** Disable



@PLYCHK1

Do Not Transmit Check Character After Verification



@PLYCHK2

Transmit Check Character After Verification



If the **Do Not Transmit Check Character After Verification** option is enabled, Plessey barcodes with a length that is less than the configured minimum length after having the check characters excluded will not be decoded. (For example, when the **Do Not Transmit Check Character After Verification** option is enabled and the minimum length is set to 4, Plessey barcodes with a total length of 4 characters including the check characters cannot be read.)



@SETUPE0

** Exit Setup



@SETUPE1

Enter Setup

MSI-Plessey

Restore Factory Defaults



@MSIDF

Restore the Factory Defaults of MSI-Plessey

Enable/Disable MSI-Plessey



@MSIENA1

Enable MSI-Plessey



@MSIENA0

**** Disable MSI-Plessey**



If the scanner fails to identify MSI-Plessey barcodes, you may first try this solution by scanning the **Enter Setup** barcode and then **Enable MSI-Plessey** barcode.



@SETUPE0

**** Exit Setup**



@SETUPE1

Enter Setup

Set Length Range for MSI-Plessey

The scanner can be configured to only decode MSI-Plessey barcodes with lengths that fall between (inclusive) the minimum and maximum lengths. To accomplish it, you need to set the minimum and maximum lengths.



@MSIMIN

Set the Minimum Length (Default: 4)



@MSIMAX

Set the Maximum Length (Default: 48)



If minimum length is set to be greater than maximum length, the scanner only decodes MSI-Plessey barcodes with either the minimum or maximum length. If minimum length is same as maximum length, only MSI-Plessey barcodes with that length are to be decoded.

E
sample

Set the scanner to decode MSI-Plessey barcodes containing between 8 and 12 characters:

1. Scan the **Enter Setup** barcode.
2. Scan the **Set the Minimum Length** barcode.
3. Scan the numeric barcode “8” from the “Digit Barcodes” section in Appendix.
4. Scan the **Save** barcode from the “Save/Cancel Barcodes” section in Appendix.
5. Scan the **Set the Maximum Length** barcode.
6. Scan the numeric barcodes “1” and “2” from the “Digit Barcodes” section in Appendix.
7. Scan the **Save** barcode from the “Save/Cancel Barcodes” section in Appendix.
8. Scan the **Exit Setup** barcode.

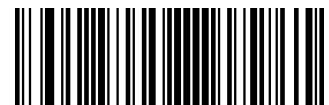

@SETUPE0

**** Exit Setup**



@SETUPE1

Enter Setup

Check Character Verification

Check characters are optional for MSI-Plessey and can be added as the last one or two characters, which are calculated values used to verify the integrity of the data.

If the **Disable** option is enabled, the scanner transmits MSI-Plessey barcodes as is.



@MSICLK0

Disable



@MSICLK1

**** One Check Character, MOD10**



@MSICLK2

Two Check Characters, MOD10/MOD10



@MSICLK3

Two Check Characters, MOD10/MOD11



@SETUPE0

**** Exit Setup**



@SETUPE1

Enter Setup

Transmit Check Character



@MSITCK1

** Transmit MSI-Plessey Check Character



@MSITCK0

Do Not Transmit MSI-Plessey Check Character



If you select a check character algorithm and the **Do Not Transmit Check Character** option, MSI-Plessey barcodes with a length that is less than the configured minimum length after having the check character(s) excluded will not be decoded. (For example, when the **One Check Character, MOD10** and **Do Not Transmit Check Character** options are enabled and the minimum length is set to 4, MSI-Plessey barcodes with a total length of 4 characters including the check character cannot be read.)



@SETUPE0

** Exit Setup



@SETUPE1

Enter Setup

AIM 128

Restore Factory Defaults



@AIMDEF

Restore the Factory Defaults of AIM 128

Enable/Disable AIM 128



@AIMENA1

**** Enable AIM 128**



@AIMENA0

Disable AIM 128



If the scanner fails to identify AIM 128 barcodes, you may first try this solution by scanning the **Enter Setup** barcode and then **Enable AIM 128** barcode.



@SETUPE0

**** Exit Setup**



@SETUPE1

Enter Setup

Set Length Range for AIM 128

The scanner can be configured to only decode AIM 128 barcodes with lengths that fall between (inclusive) the minimum and maximum lengths. To accomplish it, you need to set the minimum and maximum lengths.



@AIMMIN

Set the Minimum Length (Default: 1)



@AIMMAX

Set the Maximum Length (Default: 48)



If minimum length is set to be greater than maximum length, the scanner only decodes AIM 128 barcodes with either the minimum or maximum length. If minimum length is same as maximum length, only AIM 128 barcodes with that length are to be decoded.



Set the scanner to decode AIM 128 barcodes containing between 8 and 12 characters:

1. Scan the **Enter Setup** barcode.
2. Scan the **Set the Minimum Length** barcode.
3. Scan the numeric barcode “8” from the “Digit Barcodes” section in Appendix.
4. Scan the **Save** barcode from the “Save/Cancel Barcodes” section in Appendix.
5. Scan the **Set the Maximum Length** barcode.
6. Scan the numeric barcodes “1” and “2” from the “Digit Barcodes” section in Appendix.
7. Scan the **Save** barcode from the “Save/Cancel Barcodes” section in Appendix.
8. Scan the **Exit Setup** barcode.

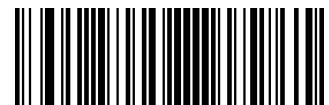

@SETUPE0

** Exit Setup



@SETUPE1

Enter Setup

ISBT 128

Restore Factory Defaults



@IBTDEF

Restore the Factory Defaults of ISBT 128

Enable/Disable ISBT 128



@IBTENA1

Enable ISBT 128



@IBTENA0

**** Disable ISBT 128**



If the scanner fails to identify ISBT 128 barcodes, you may first try this solution by scanning the **Enter Setup** barcode and then **Enable ISBT 128** barcode.



@SETUPE0

**** Exit Setup**

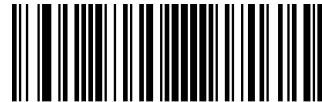

@SETUPE1

Enter Setup

Code 49

Restore Factory Defaults



@C49DEF

Restore the Factory Defaults of Code 49

Enable/Disable Code 49



@C49ENA1

Enable Code 49



@C49ENA0

**** Disable Code 49**



If the scanner fails to identify Code 49 barcodes, you may first try this solution by scanning the **Enter Setup** barcode and then **Enable Code 49** barcode.



@SETUPE0

**** Exit Setup**



@SETUPE1
Enter Setup

Set Length Range for Code 49

The scanner can be configured to only decode Code 49 barcodes with lengths that fall between (inclusive) the minimum and maximum lengths. To accomplish it, you need to set the minimum and maximum lengths.



Set the Minimum Length (Default: 1)



Set the Maximum Length (Default: 80)



If minimum length is set to be greater than maximum length, the scanner only decodes Code 49 barcodes with either the minimum or maximum length. If minimum length is same as maximum length, only Code 49 barcodes with that length are to be decoded.

E *example*

Set the scanner to decode Code 49 barcodes containing between 8 and 12 characters:

1. Scan the **Enter Setup** barcode.
2. Scan the **Set the Minimum Length** barcode.
3. Scan the numeric barcode “8” from the “Digit Barcodes” section in Appendix.
4. Scan the **Save** barcode from the “Save/Cancel Barcodes” section in Appendix.
5. Scan the **Set the Maximum Length** barcode.
6. Scan the numeric barcodes “1” and “2” from the “Digit Barcodes” section in Appendix.
7. Scan the **Save** barcode from the “Save/Cancel Barcodes” section in Appendix.
8. Scan the **Exit Setup** barcode.



@SETUPE0
**** Exit Setup**



@SETUPE1

Enter Setup

Code 16K

Restore Factory Defaults



@16KDEF

Restore the Factory Defaults of Code 16K

Enable/Disable Code 16K



@16KENA1

Enable Code 16K



@16KENA0

**** Disable Code 16K**



If the scanner fails to identify Code 16K barcodes, you may first try this solution by scanning the **Enter Setup** barcode and then **Enable Code 16K** barcode.



@SETUPE0

**** Exit Setup**



@SETUPE1
Enter Setup

Set Length Range for Code 16K

The scanner can be configured to only decode Code 16K barcodes with lengths that fall between (inclusive) the minimum and maximum lengths. To accomplish it, you need to set the minimum and maximum lengths.



@16KMIN

Set the Minimum Length (Default: 1)



@16KMAX

Set the Maximum Length (Default: 80)



If minimum length is set to be greater than maximum length, the scanner only decodes Code 16K barcodes with either the minimum or maximum length. If minimum length is same as maximum length, only Code 16K barcodes with that length are to be decoded.



Set the scanner to decode Code 16K barcodes containing between 8 and 12 characters:

1. Scan the **Enter Setup** barcode.
2. Scan the **Set the Minimum Length** barcode.
3. Scan the numeric barcode “8” from the “Digit Barcodes” section in Appendix.
4. Scan the **Save** barcode from the “Save/Cancel Barcodes” section in Appendix.
5. Scan the **Set the Maximum Length** barcode.
6. Scan the numeric barcodes “1” and “2” from the “Digit Barcodes” section in Appendix.
7. Scan the **Save** barcode from the “Save/Cancel Barcodes” section in Appendix.
8. Scan the **Exit Setup** barcode.



@SETUPE0
**** Exit Setup**



@SETUPE1

Enter Setup

PDF417

Restore Factory Defaults



@PDFDEF

Restore the Factory Defaults of PDF417

Enable/Disable PDF417



@PDFENA1

**** Enable PDF417**



@PDFENA0

Disable PDF417



If the scanner fails to identify PDF417 barcodes, you may first try this solution by scanning the **Enter Setup** barcode and then **Enable PDF417** barcode.



@SETUPE0

**** Exit Setup**



@SETUPE1
Enter Setup

Set Length Range for PDF417

The scanner can be configured to only decode PDF417 barcodes with lengths that fall between (inclusive) the minimum and maximum lengths. To accomplish it, you need to set the minimum and maximum lengths.



Set the Minimum Length (Default: 1)



Set the Maximum Length (Default: 2710)



Minimum length is not allowed to be greater than maximum length. If you only want to read PDF417 barcodes with a specific length, set both minimum and maximum lengths to be that desired length.

Set the scanner to decode PDF417 barcodes containing between 8 and 12 characters:

E
xample

1. Scan the **Enter Setup** barcode.
2. Scan the **Set the Minimum Length** barcode.
3. Scan the numeric barcode “8” from the “Digit Barcodes” section in Appendix.
4. Scan the **Save** barcode from the “Save/Cancel Barcodes” section in Appendix.
5. Scan the **Set the Maximum Length** barcode.
6. Scan the numeric barcodes “1” and “2” from the “Digit Barcodes” section in Appendix.
7. Scan the **Save** barcode from the “Save/Cancel Barcodes” section in Appendix.
8. Scan the **Exit Setup** barcode.



@SETUPE0
**** Exit Setup**



@SETUPE1

Enter Setup

PDF417 Twin Code

PDF417 twin code is 2 PDF417 barcodes paralleled vertically or horizontally. They must both be either regular or inverse barcodes. They must have similar specifications and be placed closely together.

There are 3 options for reading PDF417 twin codes:

- ◇ **Single PDF417 Only:** Read either PDF417 code.
- ◇ **Twin PDF417 Only:** Read both PDF417 codes.
- ◇ **Both Single & Twin:** Read both PDF417 codes. If successful, transmit as twin PDF417 only. Otherwise, try single PDF417 only.



@PDFDOU0

**** Single PDF417 Only**



@PDFDOU1

Twin PDF417 Only



@PDFDOU2

Both Single & Twin



@SETUPE0

**** Exit Setup**



@SETUPE1

Enter Setup

PDF417 Inverse

Regular barcode: Dark bars on a bright background.

Inverse barcode: Bright bars on a dark background.

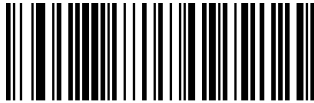

@PDFINV0

**** Decode Regular PDF417 Barcodes Only**

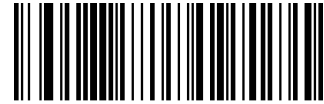

@PDFINV1

Decode Inverse PDF417 Barcodes Only



@PDFINV2

Decode Both

Character Encoding

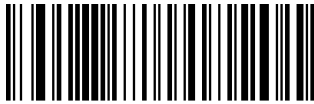

@PDFENC0

**** Default Character Encoding**

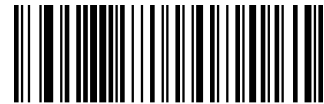

@PDFENC1

UTF-8



@PDFENC2

Automatically select UTF-8 or Code Page



@SETUPE0

**** Exit Setup**



@SETUPE1

Enter Setup

PDF417 ECI Output



@PDFECI0

Disable PDF417 ECI Output



@PDFECI1

**** Enable PDF417 ECI Output**



@SETUPE0

**** Exit Setup**



@SETUPE1

Enter Setup

Micro PDF417

Restore Factory Defaults



@MPDDEF

Restore the Factory Defaults of Micro PDF417

Enable/Disable Micro PDF417



@MPDENA1

Enable Micro PDF417



@MPDENA0

**** Disable Micro PDF417**



If the scanner fails to identify Micro PDF417 barcodes, you may first try this solution by scanning the **Enter Setup** barcode and then **Enable Micro PDF417** barcode.

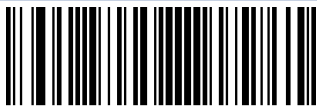

@SETUPE0

**** Exit Setup**



@SETUPE1

Enter Setup

Set Length Range for Micro PDF417

The scanner can be configured to only decode Micro PDF417 barcodes with lengths that fall between (inclusive) the minimum and maximum lengths. To accomplish it, you need to set the minimum and maximum lengths.



@MPDMIN

Set the Minimum Length (Default: 1)



@MPDMAX

Set the Maximum Length (Default: 366)



Minimum length is not allowed to be greater than maximum length. If you only want to read Micro PDF417 barcodes with a specific length, set both minimum and maximum lengths to be that desired length.

E
example

Set the scanner to decode Micro PDF417 barcodes containing between 8 and 12 characters:

1. Scan the **Enter Setup** barcode.
2. Scan the **Set the Minimum Length** barcode.
3. Scan the numeric barcode “8” from the “Digit Barcodes” section in Appendix.
4. Scan the **Save** barcode from the “Save/Cancel Barcodes” section in Appendix.
5. Scan the **Set the Maximum Length** barcode.
6. Scan the numeric barcodes “1” and “2” from the “Digit Barcodes” section in Appendix.
7. Scan the **Save** barcode from the “Save/Cancel Barcodes” section in Appendix.
8. Scan the **Exit Setup** barcode.



@SETUPE0

**** Exit Setup**



@SETUPE1

Enter Setup

QR Code

Restore Factory Defaults



@QRCDEF

Restore the Factory Defaults of QR Code

Enable/Disable QR Code



@QRCENA1

**** Enable QR Code**



@QRCENA0

Disable QR Code



If the scanner fails to identify QR Code barcodes, you may first try this solution by scanning the **Enter Setup** barcode and then **Enable QR Code** barcode.



@SETUPE0

**** Exit Setup**



@SETUPE1

Enter Setup

Set Length Range for QR Code

The scanner can be configured to only decode QR Code barcodes with lengths that fall between (inclusive) the minimum and maximum lengths. To accomplish it, you need to set the minimum and maximum lengths.



@QRDMIN

Set the Minimum Length (Default: 1)



@QRDMAX

Set the Maximum Length (Default: 7089)



Minimum length is not allowed to be greater than maximum length. If you only want to read QR Code barcodes with a specific length, set both minimum and maximum lengths to be that desired length.

E *example*

Set the scanner to decode QR Code barcodes containing between 8 and 12 characters:

1. Scan the **Enter Setup** barcode.
2. Scan the **Set the Minimum Length** barcode.
3. Scan the numeric barcode “8” from the “Digit Barcodes” section in Appendix.
4. Scan the **Save** barcode from the “Save/Cancel Barcodes” section in Appendix.
5. Scan the **Set the Maximum Length** barcode.
6. Scan the numeric barcodes “1” and “2” from the “Digit Barcodes” section in Appendix.
7. Scan the **Save** barcode from the “Save/Cancel Barcodes” section in Appendix.
8. Scan the **Exit Setup** barcode.



@SETUPE0

**** Exit Setup**



@SETUPE1

Enter Setup

QR Twin Code

QR twin code is 2 QR barcodes paralleled vertically or horizontally. They must both be either regular or inverse barcodes. They must have similar specifications and be placed closely together.

There are 3 options for reading QR twin codes:

- ◇ **Single QR Only:** Read either QR code.
- ◇ **Twin QR Only:** Read both QR codes. Transmission sequence: left (upper) QR code followed by right (lower) QR code.
- ◇ **Both Single & Twin:** Read both QR codes. If successful, transmit as twin QR only. Otherwise, try single QR only.



@QRCDU0

**** Single QR Only**



@QRCDU1

Twin QR Only



@QRCDU2

Both Single & Twin



@SETUPE0

**** Exit Setup**



@SETUPE1

Enter Setup

QR Inverse

Regular barcode: Dark bars on a bright background.

Inverse barcode: Bright bars on a dark background.



@QRCINV0

**** Decode Regular QR Barcodes Only**



@QRCINV1

Decode Inverse QR Barcodes Only

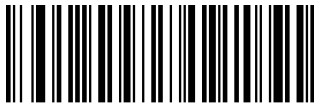

@QRCINV2

Decode Both

Character Encoding



@QRCENC0

**** Default Character Encoding**



@QRCENC1

UTF-8



@QRCENC3

Automatically select UTF-8 or Code Page



@SETUPE0

**** Exit Setup**



@SETUPE1

Enter Setup

QR ECI Output



@QRCECI0

Disable QR ECI Output



@QRCECI1

**** Enable QR ECI Output**



@SETUPE0

**** Exit Setup**



@SETUPE1
Enter Setup

Micro QR Code

Restore Factory Defaults



@MQRDEF
Restore the Factory Defaults of Micro QR

Enable/Disable Micro QR



@MQRENA1
**** Enable Micro QR**



@MQRENA0
Disable Micro QR



If the scanner fails to identify Micro QR barcodes, you may first try this solution by scanning the **Enter Setup** barcode and then **Enable Micro QR** barcode.



@SETUPE0
**** Exit Setup**



@SETUPE1
Enter Setup

Set Length Range for Micro QR

The scanner can be configured to only decode Micro QR barcodes with lengths that fall between (inclusive) the minimum and maximum lengths. To accomplish it, you need to set the minimum and maximum lengths.



@MQRMIN
Set the Minimum Length (Default: 1)



@MQRMAX
Set the Maximum Length (Default: 35)



Minimum length is not allowed to be greater than maximum length. If you only want to read Micro QR barcodes with a specific length, set both minimum and maximum lengths to be that desired length.



Set the scanner to decode Micro QR Code barcodes containing between 8 and 12 characters:

1. Scan the **Enter Setup** barcode.
2. Scan the **Set the Minimum Length** barcode.
3. Scan the numeric barcode “8” from the “Digit Barcodes” section in Appendix.
4. Scan the **Save** barcode from the “Save/Cancel Barcodes” section in Appendix.
5. Scan the **Set the Maximum Length** barcode.
6. Scan the numeric barcodes “1” and “2” from the “Digit Barcodes” section in Appendix.
7. Scan the **Save** barcode from the “Save/Cancel Barcodes” section in Appendix.
8. Scan the **Exit Setup** barcode.



@SETUPE0
**** Exit Setup**



@SETUPE1

Enter Setup

Aztec

Restore Factory Defaults



@AZTDEF

Restore the Factory Defaults of Aztec Code

Enable/Disable Aztec Code



@AZTENA1

Enable Aztec Code



@AZTENA0

**** Disable Aztec Code**



If the scanner fails to identify Aztec Code barcodes, you may first try this solution by scanning the **Enter Setup** barcode and then **Enable Aztec Code** barcode.



@SETUPE0

**** Exit Setup**



@SETUPE1
Enter Setup

Set Length Range for Aztec Code

The scanner can be configured to only decode Aztec barcodes with lengths that fall between (inclusive) the minimum and maximum lengths. To accomplish it, you need to set the minimum and maximum lengths.



@AZTMIN
Set the Minimum Length (Default: 1)



@AZTMAX
Set the Maximum Length (Default: 3832)



Minimum length is not allowed to be greater than maximum length. If you only want to read Aztec barcodes with a specific length, set both minimum and maximum lengths to be that desired length.

E
xample

Set the scanner to decode Aztec barcodes containing between 8 and 12 characters:

1. Scan the **Enter Setup** barcode.
2. Scan the **Set the Minimum Length** barcode.
3. Scan the numeric barcode “8” from the “Digit Barcodes” section in Appendix.
4. Scan the **Save** barcode from the “Save/Cancel Barcodes” section in Appendix.
5. Scan the **Set the Maximum Length** barcode.
6. Scan the numeric barcodes “1” and “2” from the “Digit Barcodes” section in Appendix.
7. Scan the **Save** barcode from the “Save/Cancel Barcodes” section in Appendix.
8. Scan the **Exit Setup** barcode.



@SETUPE0
** Exit Setup



@SETUPE1

Enter Setup

Read Multi-barcodes on an Image

There are three options:

- ◇ **Mode 1:** Read one barcode only.
- ◇ **Mode 2:** Read fixed number of barcodes only.
- ◇ **Mode 3:** Composite Reading. Read fixed number of barcodes first. If unsuccessful, read one barcode only.



@AZTMOD1

** Mode 1



@AZTMOD2

Mode 2



@AZTMOD3

Mode 3



@SETUPE0

** Exit Setup



@SETUPE1

Enter Setup

Set the Number of Barcodes



@AZTMUL1

** 1

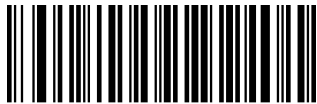

@AZTMUL3

3

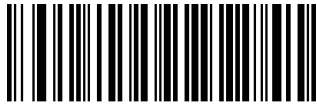

@AZTMUL5

5

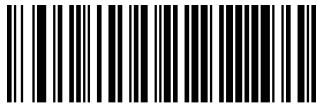

@AZTMUL7

7



@AZTMUL2

2



@AZTMUL4

4



@AZTMUL6

6



@AZTMUL8

8



@SETUPE0

** Exit Setup



@SETUPE1
Enter Setup

Character Encoding



@AZTENC0
** Default Character Encoding



@AZTENC1
UTF-8



@AZTENC2
Automatically select UTF-8 or Code Page

Aztec ECI Output



@AZTECI0
Disable Aztec ECI Output



@AZTECI1
** Enable Aztec ECI Output



@SETUPE0
** Exit Setup



@SETUPE1

Enter Setup

Data Matrix

Restore Factory Defaults



@DMCDEF

Restore the Factory Defaults of Data Matrix

Enable/Disable Data Matrix



@DMCENA1

**** Enable Data Matrix**



@DMCENA0

Disable Data Matrix



If the scanner fails to identify Data Matrix barcodes, you may first try this solution by scanning the **Enter Setup** barcode and then **Enable Data Matrix** barcode.



@SETUPE0

**** Exit Setup**



@SETUPE1

Enter Setup

Set Length Range for Data Matrix

The scanner can be configured to only decode Data Matrix barcodes with lengths that fall between (inclusive) the minimum and maximum lengths. To accomplish it, you need to set the minimum and maximum lengths.



@DMCMIN

Set the Minimum Length (Default: 1)



@DMCMAX

Set the Maximum Length (Default: 3116)



Minimum length is not allowed to be greater than maximum length. If you only want to read Data Matrix barcodes with a specific length, set both minimum and maximum lengths to be that desired length.

E *sample*

Set the scanner to decode Data Matrix barcodes containing between 8 and 12 characters:

1. Scan the **Enter Setup** barcode.
2. Scan the **Set the Minimum Length** barcode.
3. Scan the numeric barcode “8” from the “Digit Barcodes” section in Appendix.
4. Scan the **Save** barcode from the “Save/Cancel Barcodes” section in Appendix.
5. Scan the **Set the Maximum Length** barcode.
6. Scan the numeric barcodes “1” and “2” from the “Digit Barcodes” section in Appendix.
7. Scan the **Save** barcode from the “Save/Cancel Barcodes” section in Appendix.
8. Scan the **Exit Setup** barcode.



@SETUPE0

**** Exit Setup**



@SETUPE1

Enter Setup

Data Matrix Twin Code

Data Matrix twin code is 2 Data Matrix barcodes paralleled vertically or horizontally. They must both be either regular or inverse barcodes. They must have similar specifications and be placed closely together.

There are 3 options for reading Data Matrix twin codes:

- ◇ **Single Data Matrix Only:** Read either Data Matrix code.
- ◇ **Twin Data Matrix Only:** Read both Data Matrix codes. Transmission sequence: left (upper) Data Matrix code followed by right (lower) Data Matrix code.
- ◇ **Both Single & Twin:** Read both Data Matrix codes. If successful, transmit as twin Data Matrix only. Otherwise, try single Data Matrix only.



@DMCDOU0

**** Single Data Matrix Only**



@DMCDOU1

Twin Data Matrix Only



@DMCDOU2

Both Single & Twin



@SETUPE0

**** Exit Setup**



@SETUPE1

Enter Setup

Rectangular Barcode

Data Matrix has two formats:

Square barcodes having the same amount of modules in length and width: 10*10, 12*12.... 144*144.

Rectangular barcodes having different amounts of models in length and width: 6*16, 6*14...14*22.



@DMCREC1

**** Enable Rectangular Barcode**



@DMCREC0

Disable Rectangular Barcode

Data Matrix Inverse

Regular barcode: Dark bars on a bright background.

Inverse barcode: Bright bars on a dark background.



@DMCINV0

**** Decode Regular Data Matrix Barcodes Only**



@DMCINV1

Decode Inverse Data Matrix Barcodes Only

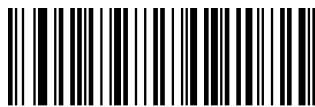

@DMCINV2

Decode Both



@SETUPE0

**** Exit Setup**



@SETUPE1

Enter Setup

Character Encoding



@DMCENC0

**** Default Character Encoding**



@DMCENC1

UTF-8

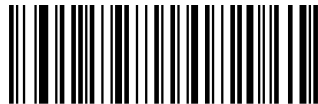

@DMCENC2

Automatically select UTF-8 or Code Page

Data Matrix ECI Output



@DMCEC10

Disable Data Matrix ECI Output



@DMCEC11

**** Enable Data Matrix ECI Output**



@SETUPE0

**** Exit Setup**



@SETUPE1

Enter Setup

Maxicode

Restore Factory Defaults



@MXCDEF

Restore the Factory Defaults of Maxicode

Enable/Disable Maxicode



@MXCENA1

Enable Maxicode



@MXCENA0

**** Disable Maxicode**



If the scanner fails to identify Maxicode barcodes, you may first try this solution by scanning the **Enter Setup** barcode and then **Enable Maxicode** barcode.



@SETUPE0

**** Exit Setup**



@SETUPE1

Enter Setup

Set Length Range for Maxicode

The scanner can be configured to only decode Maxicode barcodes with lengths that fall between (inclusive) the minimum and maximum lengths. To accomplish it, you need to set the minimum and maximum lengths.



@MXCMIN

Set the Minimum Length (Default: 1)



@MXCMAX

Set the Maximum Length (Default:150)



Minimum length is not allowed to be greater than maximum length. If you only want to read Maxicode barcodes with a specific length, set both minimum and maximum lengths to be that desired length.

E *xample*

Set the scanner to decode Maxicode barcodes containing between 8 and 12 characters:

1. Scan the **Enter Setup** barcode.
2. Scan the **Set the Minimum Length** barcode.
3. Scan the numeric barcode “8” from the “Digit Barcodes” section in Appendix.
4. Scan the **Save** barcode from the “Save/Cancel Barcodes” section in Appendix.
5. Scan the **Set the Maximum Length** barcode.
6. Scan the numeric barcodes “1” and “2” from the “Digit Barcodes” section in Appendix.
7. Scan the **Save** barcode from the “Save/Cancel Barcodes” section in Appendix.
8. Scan the **Exit Setup** barcode.



@SETUPE0

**** Exit Setup**



@SETUPE1
Enter Setup

Chinese Sensible Code

Restore Factory Defaults



@CSCDEF

Restore the Factory Defaults of Chinese Sensible Code

Enable/Disable Chinese Sensible Code



@CSCENA1

Enable Chinese Sensible Code



@CSCENA0

**** Disable Chinese Sensible Code**



If the scanner fails to identify Chinese Sensible Code barcodes, you may first try this solution by scanning the **Enter Setup** barcode and then **Enable Chinese Sensible Code** barcode.



@SETUPE0

**** Exit Setup**



@SETUPE1
Enter Setup

Set Length Range for Chinese Sensible Code

The scanner can be configured to only decode Chinese Sensible Code barcodes with lengths that fall between (inclusive) the minimum and maximum lengths. To accomplish it, you need to set the minimum and maximum lengths.



@CSCMIN
Set the Minimum Length (Default: 1)



@CSCMAX
Set the Maximum Length (Default: 7827)



Minimum length is not allowed to be greater than maximum length. If you only want to read Chinese Sensible Code barcodes with a specific length, set both minimum and maximum lengths to be that desired length.

E *sample*

Set the scanner to decode Chinese Sensible Code barcodes containing between 8 and 12 characters:

1. Scan the **Enter Setup** barcode.
2. Scan the **Set the Minimum Length** barcode.
3. Scan the numeric barcode “8” from the “Digit Barcodes” section in Appendix.
4. Scan the **Save** barcode from the “Save/Cancel Barcodes” section in Appendix.
5. Scan the **Set the Maximum Length** barcode.
6. Scan the numeric barcodes “1” and “2” from the “Digit Barcodes” section in Appendix.
7. Scan the **Save** barcode from the “Save/Cancel Barcodes” section in Appendix.
8. Scan the **Exit Setup** barcode.



@SETUPE0
**** Exit Setup**



@SETUPE1

Enter Setup

Chinese Sensible Twin Code

Chinese Sensible twin code is 2 Chinese Sensible barcodes paralleled vertically or horizontally. They must both be either regular or inverse barcodes. They must have similar specifications and be placed closely together.

There are 3 options for reading Chinese Sensible twin codes:

- ◇ **Single Chinese Sensible Code Only:** Read either Chinese Sensible code.
- ◇ **Twin Chinese Sensible Code Only:** Read both Chinese Sensible codes. Transmission sequence: left (upper) Chinese Sensible code followed by right (lower) Chinese Sensible code.
- ◇ **Both Single & Twin:** Read both Chinese Sensible codes. If successful, transmit as twin Chinese Sensible Code only. Otherwise, try single Chinese Sensible Code only.

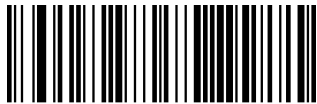

@CSCDOU0

**** Single Chinese Sensible Code Only**



@CSCDOU1

Twin Chinese Sensible Code Only



@CSCDOU2

Both Single & Twin



@SETUPE0

**** Exit Setup**



@SETUPE1

Enter Setup

Chinese Sensible Code Inverse

Regular barcode: Dark bars on a bright background.

Inverse barcode: Bright bars on a dark background.



@CSCINV0

**** Decode Regular Chinese Sensible Barcodes Only**

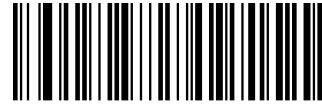

@CSCINV1

Decode Inverse Chinese Sensible Barcodes Only



@CSCINV2

Decode Both



@SETUPE0

**** Exit Setup**



@SETUPE1

Enter Setup

GM Code

Restore Factory Defaults



@GMCDEF

Restore the Factory Defaults of GM

Enable/Disable GM



@GMCENA1

Enable GM



@GMCENA0

**** Disable GM**



If the scanner fails to identify GM barcodes, you may first try this solution by scanning the **Enter Setup** barcode and then **Enable GM** barcode.



@SETUPE0

**** Exit Setup**



@SETUPE1
Enter Setup

Set Length Range for GM

The scanner can be configured to only decode GM barcodes with lengths that fall between (inclusive) the minimum and maximum lengths. To accomplish it, you need to set the minimum and maximum lengths.



@GMCMIN
Set the Minimum Length (Default: 1)



@GMC MAX
Set the Maximum Length (Default: 2751)



Minimum length is not allowed to be greater than maximum length. If you only want to read GM barcodes with a specific length, set both minimum and maximum lengths to be that desired length.



Set the scanner to decode GM barcodes containing between 8 and 12 characters:

1. Scan the **Enter Setup** barcode.
2. Scan the **Set the Minimum Length** barcode.
3. Scan the numeric barcode “8” from the “Digit Barcodes” section in Appendix.
4. Scan the **Save** barcode from the “Save/Cancel Barcodes” section in Appendix.
5. Scan the **Set the Maximum Length** barcode.
6. Scan the numeric barcodes “1” and “2” from the “Digit Barcodes” section in Appendix.
7. Scan the **Save** barcode from the “Save/Cancel Barcodes” section in Appendix.
8. Scan the **Exit Setup** barcode.



@SETUPE0
**** Exit Setup**



@SETUPE1

Enter Setup

Code One

Restore Factory Defaults



@ONEDEF

Restore the Factory Defaults of Code One

Enable/Disable Code One



@ONEENA1

Enable Code One



@ONEENA0

**** Disable Code One**



If the scanner fails to identify Code One barcodes, you may first try this solution by scanning the **Enter Setup** barcode and then **Enable Code One** barcode.



@SETUPE0

**** Exit Setup**



@SETUPE1

Enter Setup

Set Length Range for Code One

The scanner can be configured to only decode Code One barcodes with lengths that fall between (inclusive) the minimum and maximum lengths. To accomplish it, you need to set the minimum and maximum lengths.



@ONEMIN

Set the Minimum Length (Default: 1)



@ONEMAX

Set the Maximum Length (Default: 3550)



Minimum length is not allowed to be greater than maximum length. If you only want to read Code One barcodes with a specific length, set both minimum and maximum lengths to be that desired length.

E *sample*

Set the scanner to decode Code One barcodes containing between 8 and 12 characters:

1. Scan the **Enter Setup** barcode.
2. Scan the **Set the Minimum Length** barcode.
3. Scan the numeric barcode “8” from the “Digit Barcodes” section in Appendix.
4. Scan the **Save** barcode from the “Save/Cancel Barcodes” section in Appendix.
5. Scan the **Set the Maximum Length** barcode.
6. Scan the numeric barcodes “1” and “2” from the “Digit Barcodes” section in Appendix.
7. Scan the **Save** barcode from the “Save/Cancel Barcodes” section in Appendix.
8. Scan the **Exit Setup** barcode.



@SETUPE0

**** Exit Setup**



@SETUPE1

Enter Setup

USPS Postnet

Restore Factory Defaults



@PNTDEF

Restore the Factory Defaults of USPS Postnet

Enable/Disable USPS Postnet



@PNTENA1

Enable USPS Postnet



@PNTENA0

** Disable USPS Postnet



If the scanner fails to identify USPS Postnet barcodes, you may first try this solution by scanning the **Enter Setup** barcode and then **Enable USPS Postnet** barcode.

Transmit Check Character



@PNTCHK1

Do Not Transmit USPS Postnet Check Character



@PNTCHK2

** Transmit USPS Postnet Check Character



@SETUPE0

** Exit Setup



@SETUPE1

Enter Setup

USPS Intelligent Mail

Restore Factory Defaults



@ILGDEF

Restore the Factory Defaults of USPS Intelligent Mail

Enable/Disable USPS Intelligent Mail



@ILGENA1

Enable USPS Intelligent Mail



@ILGENA0

**** Disable USPS Intelligent Mail**



If the scanner fails to identify USPS Intelligent Mail barcodes, you may first try this solution by scanning the **Enter Setup** barcode and then **Enable USPS Intelligent Mail** barcode.



@SETUPE0

**** Exit Setup**



@SETUPE1

Enter Setup

Royal Mail

Restore Factory Defaults



@ROYDEF

Restore the Factory Defaults of Royal Mail

Enable/Disable Royal Mail



@ROYENA1

Enable Royal Mail

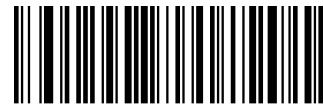

@ROYENA0

**** Disable Royal Mail**



If the scanner fails to identify Royal Mail barcodes, you may first try this solution by scanning the **Enter Setup** barcode and then **Enable Royal Mail** barcode.



@SETUPE0

**** Exit Setup**



@SETUPE1

Enter Setup

USPS Planet

Restore Factory Defaults



@PLADEF

Restore the Factory Defaults of USPS Planet

Enable/Disable USPS Planet



@PLAENA1

Enable USPS Planet



@PLAENA0

** Disable USPS Planet



If the scanner fails to identify USPS Planet barcodes, you may first try this solution by scanning the **Enter Setup** barcode and then **Enable USPS Planet** barcode.

Transmit Check Character



@PLACHK1

Do Not Transmit USPS Planet Check Character

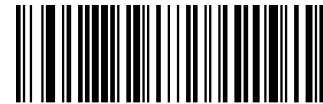

@PLACHK2

** Transmit USPS Planet Check Character



@SETUPE0

** Exit Setup



@SETUPE1

Enter Setup

KIX Post

Restore Factory Defaults



@KIXDEF

Restore the Factory Defaults of KIX Post

Enable/Disable KIX Post



@KIXENA1

Enable KIX Post



@KIXENA0

**** Disable KIX Post**



If the scanner fails to identify KIX Post barcodes, you may first try this solution by scanning the **Enter Setup** barcode and then **Enable KIX Post** barcode.



@SETUPE0

**** Exit Setup**



@SETUPE1

Enter Setup

Australian Postal

Restore Factory Defaults



@APLDEF

Restore the Factory Defaults of Australian Postal

Enable/Disable Australian Postal



@APLENA1

Enable Australian Postal



@APLENA0

**** Disable Australian Postal**



If the scanner fails to identify Australian Postal barcodes, you may first try this solution by scanning the **Enter Setup** barcode and then **Enable Australian Postal** barcode.



@SETUPE0

**** Exit Setup**



@SETUPE1

Enter Setup

Passport OCR

Restore Factory Defaults



@PASDEF

Restore the Factory Defaults of Passport OCR

Enable/Disable Passport OCR



@PASENA1

Enable Passport OCR



@PASENA0

**** Disable Passport OCR**



If the scanner fails to identify Passport OCR barcodes, you may first try this solution by scanning the **Enter Setup** barcode and then **Enable Passport OCR** barcode.



@SETUPE0

**** Exit Setup**



@SETUPE1
Enter Setup

Chapter 7 Data Formatter

Introduction

You may use the Data Formatter to modify the scanner's output. For example, you can use the Data Formatter to insert characters at certain points in barcode data or to suppress/ replace/ send certain characters in barcode data as it is scanned.

Normally, when you scan a barcode, it gets outputted automatically; however, when you create a format, you must use a "send" command (see the "Send Commands" section in this chapter) within the format programming to output data. Multiple data formats can be programmed into the scanner. The maximum size of all data formats created is 2048 characters. By default, the data formatter is disabled. Enable it when required. If you have changed data format settings, and wish to clear all formats and return to the factory defaults, scan the **Default Data Format** barcode below.



@DFMDEF
**** Default Data Format**

Add a Data Format

Data format is used to edit barcode data. When you create a data format, you must select one of the four labels (Format_0, Format_1, Format_2 and Format_3) for your data format, specify the application scope of data format (such as barcode type and data length) and include formatter commands. Multiple data formats may be created using the same label. When scanned data does not match your data format requirements, you will hear the non-match error beep (if the non-match error beep is ON).

There are two methods to program a data format: Programming with barcodes and programming with serial commands.

Programming with Barcodes

The following explains how to program a data format by scanning the specific barcodes. Scanning any irrelevant barcode or failing to follow the setting procedure will result in programming failure. To find the alphanumeric barcodes needed to create a data format, see the "Digit Barcodes" section in Appendix.

Step 1: Scan the **Enter Setup** barcode.



@SETUPE0
**** Exit Setup**



@SETUPE1

Enter Setup

Step 2: Scan the **Add Data Format** barcode.



@DFMADD

Add Data Format

Step 3: Select a label (Format_0 or Format_1 or Format_2 or Format_3).

Scan a numeric barcode **0** or **1** or **2** or **3** to label this data format Format_0 or Format_1 or Format_2 or Format_3.

Step 4: Select formatter command type.

Specify what type of formatter commands will be used. Scan a numeric barcode “6” to select formatter command type 6.

(See the “Formatter Command Type 6” section in this chapter for more information)

Step 5: Set interface type

Scan **999** for any interface type.

Step 6: Set Symbology ID Number

Refer to the “Symbology ID Number” section in Appendix and find the ID number of the symbology to which you want to apply the data format. Scan three numeric barcodes for the symbology ID number. If you wish to create a data format for all symbologies, scan **999**.

Step 7: Set barcode data length

Specify what length of data will be acceptable for this symbology. Scan the four numeric barcodes that represent the data length. 9999 is a universal number, indicating all lengths. For example, 32 characters should be entered as 0032.

Step 8: Enter formatter command

Refer to the “Formatter Command Type 6” section in this chapter. Scan the alphanumeric barcodes that represent the command you need to edit data. For example, when a command is F141, you should scan F141.

Step 9: Scan the **Save** barcode from the “Save/Cancel Barcodes” section in Appendix to save your data format.



@SETUPE0

**** Exit Setup**



@SETUPE1

Enter Setup

Example: Program a Format_0 data format using formatter command type 6, Code 128 containing 10 characters applicable, send all characters followed by "A".

- | | |
|---|---|
| 1. Scan the Enter Setup barcode | Enter the Setup mode |
| 2. Scan the Add Data Format barcode | Add a data format |
| 3. Scan the 0 barcode | Select Format_0 as the label |
| 4. Scan the 6 barcode | Select formatter command type 6 |
| 5. Scan the 9 barcode three times | All interface types applicable |
| 6. Scan the barcodes 002 | Only Code 128 applicable |
| 7. Scan the barcodes 0010 | Only a length of 10 characters applicable |
| 8. Scan the alphanumeric barcodes F141 | Send all characters followed by "A" (HEX: 41) |
| 9. Scan the Save barcode | Save the data format |

To streamline the programming process, you may as well generate a batch barcode by inputting the command (e.g. **@DFMADD069990020010F141;**) used to create a data format. See the "Use Batch Barcode" section in Chapter 10 to learn how to put a batch barcode into use.

When creating multiple data formats sharing a label, the formats are separated from each other by a vertical bar (|) in the batch command, e.g. **@DFMADD069990029999F141|069990039999F142|169990049999F143;**.



@SETUPE0

** Exit Setup



@SETUPE1

Enter Setup

Programming with Serial Commands

A data format can also be created by serial commands (HEX) sent from the host device. **All commands must be entered in uppercase letters.**

The syntax consists of the following elements:

Prefix: “~<SOH>0000” (HEX: **7E 01 30 30 30 30**), 6 characters.

Storage type: “@” (HEX: **40**) or “#” (HEX: **23**), 1 character. “@” means permanent setting which will not be lost by removing power from the scanner or rebooting it; “#” means temporary setting which will be lost by removing power from the scanner or rebooting it.

Add Data Format Command: “DFMADD” (HEX: **44 46 4D 41 44 44**), 6 characters.

Data format label: “0” (HEX: **30**) or “1” (HEX: **31**) or “2” (HEX: **32**) or “3” (HEX: **33**), 1 character. “0”, “1”, “2” and “3” represent Format_0, Format_1, Format_2 and Format_3 respectively.

Formatter command type: “6” (HEX: **36**), 1 character.

Interface type: “999” (HEX: **39 39 39**), 3 characters.

Symbology ID Number: The ID number of the symbology to which you want to apply the data format, 3 characters. 999 indicates all symbologies.

Data length: The length of data that will be acceptable for this symbology, 4 characters. 9999 indicates all lengths. For example, 32 characters should be entered as 0032.

Formatter commands: The command string used to edit data. For more information, see the “Formatter Command Type 6” section in this chapter.

Suffix: “;<ETX>” (HEX: **3B 03**), 2 characters.

Example: Program a Format_0 data format using formatter command type 6, Code 128 containing 10 characters applicable, send all characters followed by “A”.

Enter: **7E 01 30 30 30 30 40 44 46 4D 41 44 44 30 36 39 39 39 30 30 33 39 39 39 39 46 31 34 31 3B 03**
(~<SOH>0000@DFMADD069990020010F141;<ETX>)

Response: **02 01 30 30 30 30 40 44 46 4D 41 44 44 30 36 39 39 39 30 30 33 39 39 39 39 46 31 34 31 06 3B 03**
(<STX><SOH>0000@DFMADD069990020010F141<ACK>;<ETX>)

When creating multiple data formats sharing a label, the formats are separated from each other by a vertical bar (|) in the serial command.

Example: ~<SOH>0000@DFMADD069990020010F141|069990039999F142|069990049999F143;<ETX>



@SETUPE0

** Exit Setup



@SETUPE1
Enter Setup

Enable/Disable Data Formatter

When Data Formatter is disabled, the barcode data is outputted to the host as read, including prefixes and suffixes.



@DFMENA0
**** Disable Data Formatter**

You may wish to require the data to conform to a data format you have created. The following settings can be applied to your data format:

Enable Data Formatter, Required, Keep Prefix/Suffix: Scanned data that meets your data format requirements is modified accordingly and gets outputted along with prefixes and suffixes (if prefix and suffix are enabled). Any data that does not match your data format requirements generates an error beep (if Non-Match Error Beep is turned ON) and the data in that barcode is not transmitted.

Enable Data Formatter, Required, Drop Prefix/Suffix: Scanned data that meets your data format requirements is modified accordingly and gets outputted without prefixes and suffixes (even if prefix and suffix are enabled). Any data that does not match your data format requirements generates an error beep (if Non-Match Error Beep is turned ON) and the data in that barcode is not transmitted.

Enable Data Formatter, Not Required, Keep Prefix/Suffix: Scanned data that meets your data format requirements is modified accordingly and gets outputted along with prefixes and suffixes (if prefix and suffix are enabled). Barcode data that does not match your data format requirements is transmitted as read along with prefixes and suffixes (if prefix and suffix are enabled).

Enable Data Formatter, Not Required, Drop Prefix/Suffix: Scanned data that meets your data format requirements is modified accordingly and gets outputted without prefixes and suffixes (even if prefix and suffix are enabled). Barcode data that does not match your data format requirements is transmitted as read along with prefixes and suffixes (if prefix and suffix are enabled).



@SETUPE0
**** Exit Setup**



@SETUPE1

Enter Setup



@DFMENA1

Enable Data Formatter, Required, Keep Prefix/Suffix



@DFMENA2

Enable Data Formatter, Required, Drop Prefix/Suffix



@DFMENA3

Enable Data Formatter, Not Required, Keep Prefix/Suffix



@DFMENA4

Enable Data Formatter, Not Required, Drop Prefix/Suffix

Non-Match Error Beep

If Non-Match Error Beep is turned ON, the scanner generates an error beep when a barcode is encountered that does not match your required data format.



@DFMTON0

Non-Match Error Beep Off



@DFMTON1

**** Non-Match Error Beep On**



@SETUPE0

**** Exit Setup**



@SETUPE1

Enter Setup

Data Format Selection

After enabling the Data Formatter, you can select a data format you want to use by scanning the appropriate barcode below.



@DFMUSE0

**** Format_0**



@DFMUSE1

Format_1



@DFMUSE2

Format_2



@DFMUSE3

Format_3



@SETUPE0

**** Exit Setup**



@SETUPE1

Enter Setup

Change Data Format for a Single Scan

You can switch between data formats for a single scan. The next barcode is scanned using the data format selected here, then reverts to the format you have selected above.

For example, you may have set your scanner to use the data format you saved as Format_3. You can switch to Format_1 for a single trigger pull by scanning the **Single Scan – Format_1** barcode below. The next barcode that is scanned uses Format_1, then reverts back to Format_3.

Note: This setting will be lost by removing power from the scanner, or turning off/ rebooting the device.



@DFMSIN0

Single Scan – Format_0



@DFMSIN2

Single Scan – Format_2



@DFMSIN1

Single Scan – Format_1



@DFMSIN3

Single Scan – Format_3



@SETUPE0

**** Exit Setup**



@SETUPE1

Enter Setup

Clear Data Format

There are two methods to remove data format created from your scanner:

Delete one data format: Scan the **Clear One** barcode, a numeric barcode (0-3) and the **Save** barcode. For example, to delete Format_2, you should scan the **Clear One** barcode, the **2** barcode and the **Save** barcode

Delete all data formats: Scan the **Clear All** barcode.

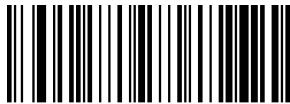

@DFMCAL

Clear All



@DFMCLR

Clear One

Query Data Formats

You may scan the appropriate barcode below to get the information of data format(s) created by you or preset by manufacturer. For instance, if you have added Format_0 as per the example in the “Add a Data Format” section in this chapter, scanning the **Query Current Data Formats** barcode, you will get the result: **Data Format0:069990020010F141;**

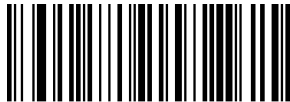

@DFMQCU

Query Current Data Formats



@DFMQFA

Query Preset Data Formats



@SETUPE0

**** Exit Setup**



@SETUPE1

Enter Setup

Formatter Command Type 6

When working with the Data Formatter, a virtual cursor is moved along your input data string. The following commands are used to both move this cursor to different positions, and to select, replace, and insert data into the final output. For the hex value of ASCII characters involved in the commands, refer to the “ASCII Table” in Appendix.

Send Commands

F1 Send all characters

Syntax=F1xx (xx: The insert character’s hex value)

Include in the output message all of the characters from the input message, starting from current cursor position, followed by an insert character.

F2 Send a number of characters

Syntax=F2nxx (nn: The numeric value (00-99) for the number of characters; xx: The insert character’s hex value)

Include in the output message a number of characters followed by an insert character. Start from the current cursor position and continue for “nn” characters or through the last character in the input message, followed by character “xx.”

F2 Example: Send a number of characters



1234567890ABCDEFGHIJ

Send the first 10 characters from the barcode above, followed by a carriage return.

Command string: **F2100D**

F2 is the “Send a number of characters” command

10 is the number of characters to send

0D is the hex value for a CR

The data is output as: **1234567890**

<CR>



@SETUPE0

** Exit Setup



@SETUPE1

Enter Setup

F3 Send all characters up to a particular character

Syntax=F3ssxx (ss: The particular character's hex value; xx: The insert character's hex value)

Include in the output message all characters from the input message, starting with the character at the current cursor position and continuing to, but not including, the particular character "ss," followed by character "xx." The cursor is moved forward to the "ss" character.

F3 Example: Send all characters up to a particular character



1234567890ABCDEFGHIJ

Using the barcode above, send all characters up to but not including "D," followed by a carriage return.

Command string: **F3440D**

F3 is the "Send all characters up to a particular character" command

44 is the hex value for a "D"

0D is the hex value for a CR

The data is output as: **1234567890ABC**

<CR>



@SETUPE0

**** Exit Setup**



@SETUPE1

Enter Setup

B9 Send all characters up to a particular string

Syntax=B9nnns...s (nnnn: The length of the particular string; s...s: The hex value of each character in the particular string)

Include in the output message all characters from the input message, starting with the character at the current cursor position and continuing to, but not including, the particular string “s...s.” The cursor is moved forward to the beginning of the “s...s” string.

B9 Example: Send all characters up to a particular string



1234567890ABCDEFGHIJ

Using the barcode above, send all characters up to but not including “AB.”

Command string: **B900024142**

B9 is the “Send all characters up to a particular string” command

0002 is the length of the particular string (2 characters)

41 is the hex value for a “A” (character in the string)

42 is the hex value for a “B” (character in the string)

The data is output as: **1234567890**

E9 Send all but the last characters

Syntax=E9nn (nn: The numeric value (00-99) for the number of characters that will not be sent at the end of the message)

Include in the output message all but the last “nn” characters, starting from the current cursor position. The cursor is moved forward to one position past the last input message character included.

F4 Insert a character multiple times

Syntax=F4xxnn (xx: The insert character’s hex value; nn: The numeric value (00-99) for the number of times it should be sent)

Send “xx” character “nn” times in the output message, leaving the cursor in the current position.



@SETUPE0

** Exit Setup



@SETUPE1

Enter Setup

E9 and F4 Example: Send all but the last characters, followed by 2 tabs



1234567890ABCDEFGHIJ

Send all characters except for the last 8 from the barcode above, followed by 2 tabs.

Command string: **E908F40902**

E9 is the “Send all but the last characters” command

08 is the number of characters at the end to ignore

F4 is the “Insert a character multiple times” command

09 is the hex value for a horizontal tab

02 is the number of time the tab character is sent

The data is output as: **1234567890AB<tab><tab>**

B3 Insert symbology name

Insert the name of the barcode’s symbology in the output message, without moving the cursor.

B4 Insert barcode length

Insert the barcode’s length in the output message, without moving the cursor. The length is expressed as a numeric string and does not include leading zeros.



@SETUPE0

** Exit Setup



@SETUPE1

Enter Setup

B3 and B4 Example: Insert the symbology name and length



1234567890ABCDEFGHIJ

Send the symbology name and length before the barcode data from the barcode above. Break up these insertions with spaces. End with a carriage return.

Command string: **B3F42001B4F42001F10D**

B3 is the "Insert symbology name" command

F4 is the "Insert a character multiple times" command

20 is the hex value for a space

01 is the number of time the space character is sent

B4 is the "Insert barcode length" command

F4 is the "Insert a character multiple times" command

20 is the hex value for a space

01 is the number of time the space character is sent

F1 is the "Send all characters" command

0D is the hex value for a CR

The data is output as: **Code128 20 1234567890ABCDEFGHIJ**

<CR>

Move Commands

F5 Move the cursor forward a number of characters

Syntax=F5nn (nn: The numeric value (00-99) for the number of characters the cursor should be moved ahead)

Move the cursor ahead "nn" characters from current cursor position.



@SETUPE0

** Exit Setup



@SETUPE1

Enter Setup

F5 Example: Move the cursor forward and send the data



1234567890ABCDEFGHIJ

Move the cursor forward 3 characters, then send the rest of the barcode data from the barcode above. End with a carriage return.

Command string: **F503F10D**

F5 is the “Move the cursor forward a number of characters” command

03 is the number of characters to move the cursor

F1 is the “Send all characters” command

0D is the hex value for a CR

The data is output as: **4567890ABCDEFGHIJ**

<CR>

F6 Move the cursor backward a number of characters

Syntax=F6nn (nn: The numeric value (00-99) for the number of characters the cursor should be moved back)

Move the cursor back “nn” characters from current cursor position.

F7 Move the cursor to the beginning

Syntax=F7

Move the cursor to the first character in the input message.

EA Move the cursor to the end

Syntax=EA

Move the cursor to the last character in the input message.



@SETUPE0

** Exit Setup



@SETUPE1

Enter Setup

Search Commands

F8 Search forward for a character

Syntax = F8xx (xx: The search character's hex value)

Search the input message forward for "xx" character from the current cursor position, leaving the cursor pointing to the "xx" character.

F8 Example: Send barcode data that starts after a particular character



1234567890ABCDEFGHIJ

Search for the letter "D" in barcodes and send all the data that follows, including the "D". Using the barcode above:

Command string: **F844F10D**

F8 is the "Search forward for a character" command

44 is the hex value for "D"

F1 is the "Send all characters" command

0D is the hex value for a CR

The data is output as: **DEFGHIJ**

<CR>

F9 Search backward for a character

Syntax = F9xx (xx: The search character's hex value)

Search the input message backward for "xx" character from the current cursor position, leaving the cursor pointing to the "xx" character.



@SETUPE0

** Exit Setup



@SETUPE1

Enter Setup

B0 Search forward for a string

Syntax=B0nnnnS (nnnn: The string length (up to 9999); S: The ASCII hex value of each character in the string)

Search forward for “S” string from the current cursor position, leaving cursor pointing to “S” string. For example, B0000454657374 will search forward for the first occurrence of the 4-character string “Test.”

B0 Example: Send barcode data that starts after a string of characters



1234567890ABCDEFGHIJ

Search for the letters “FGH” in barcodes and send all the data that follows, including “FGH.” Using the barcode above:

Command string: **B00003464748F10D**

B0 is the “Search forward for a string” command

0003 is the string length (3 characters)

46 is the hex value for “F”

47 is the hex value for “G”

48 is the hex value for “H”

F1 is the “Send all characters” command

0D is the hex value for a CR

The data is output as: **FGHIJ**

<CR>

B1 Search backward for a string

Syntax=B1nnnnS (nnnn: The string length (up to 9999); S: The ASCII hex value of each character in the string)

Search backward for “S” string from the current cursor position, leaving cursor pointing to “S” string. For example, B1000454657374 will search backward for the first occurrence of the 4-character string “Test.”



@SETUPE0

**** Exit Setup**



@SETUPE1

Enter Setup

E6 Search forward for a non-matching character

Syntax=E6xx (xx: The search character's hex value)

Search the input message forward for the first non-"xx" character from the current cursor position, leaving the cursor pointing to the non-"xx" character.

E6 Example: Remove zeros at the beginning of barcode data



0000123abc

This example shows a barcode that has been zero filled. You may want to ignore the zeros and send all the data that follows. E6 searches forward for the first character that is not zero, then sends all the data after, followed by a carriage return. Using the barcode above:

Command string: **E630F10D**

E6 is the "Search forward for a non-matching character" command

30 is the hex value for 0

F1 is the "Send all characters" command

0D is the hex value for a CR

The data is output as: **123abc**

<CR>

E7 Search backward for a non-matching character

Syntax=E7xx(xx: The search character's hex value)

Search the input message backward for the first non-"xx" character from the current cursor position, leaving the cursor pointing to the non-"xx" character.



@SETUPE0

** Exit Setup



@SETUPE1
Enter Setup

Comparison Command

B2 string is compared with B@

Syntax= B2nnnnSS1SSn (nnnn: the length of character string, SS1- SSn: the hex value of character string)

The comparison starts from the right side of the current cursor position, and the cursor moves nnnn characters to the right. If the string within the cursor movement range is equal to SS1SSn, the instruction continues to execute; otherwise, it exits.

B2 example: Send data after the specified string of character



The above barcode starts with the "Test" string, and requires the content of the Test string to be sent, and finally a carriage return.

Command string: B2000454657374F10D

B2 is the comparison of the character string" command

0004 is the string length (4 characters)

54 is the hex value for T

65 is the hex value for e

73 is the hex value for s

74 is the hex value for t

F1 is the "Send all characters" command

0D is the hex value of carriage return

The data is output as 123456<CR>

EC Check if the character to the right of the cursor is number

This command takes no parameters. If the right side of the cursor is a non-numeric, the current command is exited, otherwise execution continues.

EC example: Send barcode data that starts with number characters



The above barcode starts with number characters, requires to send barcode data, and finally sends a carriage return

Command string: ECF10D

EC is the "Check if the character to the right of the cursor is a number" command

F1 is the "Send All Characters" command

0D is the hex value for CR

The data is output as 0000123abc<CR>



@SETUPE0
** Exit Setup



@SETUPE1

Enter Setup

ED Check if the character to the right of the cursor is non-numeric

This command takes no parameters. If the right side of the cursor is a number, the current command is exited, otherwise execution continues.

ED example: Send barcode data that starts with non-numeric characters



Test123456

The above barcode starts with non-numeric characters, requires to send barcode data, and finally sends a carriage return

Command string: EDF10D

EC is the "Check if the character to the right of the cursor is a number" command

F1 is the "Send All Characters" command

0D is the hex value of carriage return

The data is output as Test123456 <CR>

FE Character Comparison

Syntax = FE xx (xx is the hex value of the character)

If the character to the right of the current cursor position is xx , execution continues; otherwise exit.

FE example: The example is a barcode that starts with the character "1" and send the first 6 bytes of the barcode.



1234567890ABCDEFGHIJ

The above barcode starts with the character "1", and requires to send the character "1" and the next 5 characters

Command string: FE31F7F2060D

FE is the "Character Compare" command

31 is the hex of the character "1"

F7 is the "Move cursor to starting position" command

F2 is the "Send several characters" command

06 is the "Send character length"

0D is the hex value of carriage return

The data is output as 123456 <CR>



@SETUPE0

** Exit Setup



@SETUPE1

Enter Setup

Miscellaneous Commands

FB Suppress characters

Syntax = FBnnxxyy..zz (nn: The numeric value (00-15) for the number of suppressed characters; xxyy..zz: The hex value of the characters to be suppressed)

Suppress all occurrences of up to 15 different characters, starting at the current cursor position, as the cursor is advanced by other commands.

FB Example: Remove spaces in barcode data



12 34_5*6 78

This example shows a barcode that has spaces in the data. You may want to remove the spaces before sending the data. Using the barcode above:

Command string: **FB0120F10D**

FB is the "Suppress characters" command

01 is the number of the characters to be suppressed

20 is the hex value for a space

F1 is the "Send all characters" command

0D is the hex value for a CR

The data is output as: **1234_5*678**

<CR>

E4 Replace characters

Syntax = E4nnxx₁xx₂yy₁yy₂...zz₁zz₂(nn: The total count of the number of characters (characters to be replaced plus replacement characters; xx₁: The characters to be replaced, xx₂: The replacement characters, continuing through zz₁ and zz₂)

Replace up to 15 characters in the output message, without moving the cursor.



@SETUPE0

** Exit Setup



@SETUPE1

Enter Setup

E4 Example: Replace zeros with CRs in barcode data



12304560780AB

If the barcode has characters that the host application does not want included, you can use the E4 command to replace those characters with something else. In this example, you will replace the zeros in the barcode above with carriage returns.

Command string: **E402300DF10D**

E4 is the "Replace characters" command

02 is the total count of characters to be replaced, plus the replacement characters (0 is replaced by CR, so total characters=2)

30 is the hex value for 0

0D is the hex value for a CR (the character that will replace the 0)

F1 is the "Send all characters" command

0D is the hex value for a CR

The data is output as: **123**

456

78

AB

<CR>



@SETUPE0

** Exit Setup



@SETUPE1

Enter Setup

BA Replace a string with another

Syntax = BAnnNN₁SS₁NN₂SS₂

nn: The count of replacements to be made, if nn=00 or nn>=the number of occurrences of a string to be replaced, then replace all occurrences of that string.

NN₁: The length of the string to be replaced, NN₁>0.

SS₁: The ASCII hex value of each character in the string to be replaced.

NN₂: The length of replacement string, NN₂>=0. To replace string "SS₁" with NUL (i.e. delete string "SS₁"), you should set NN₂ to 00 and leave out SS₂.

SS₂: The ASCII hex value of each character in the replacement string.

From the current cursor position, search forward for the occurrence of "SS₁" string (of length "NN₁") and replace the string with "SS₂" string (of length "NN₂") in the output message until every "SS₁" string is replaced or the count of replacements made reaches "nn" times, without moving the cursor.

BA Example: Replace "23"s with "ABC"s in barcode data



1234Abc23R0123U

If the barcode has a string of characters that the host application does not want included, you can use the BA command to replace the string with something else. In this example, you will replace the "23"s in the barcode above with "ABC"s.

Command string: **BA0002323303414243F100**

BA is the "Replace a string with another" command

00 is the count of replacements to be made, 00 means to replace all occurrences of that string

02 is the length of the string to be replaced

32 is the hex value for 2 (character in the string to be replaced)

33 is the hex value for 3 (character in the string to be replaced)

03 is the length of the replacement string



@SETUPE0

**** Exit Setup**



@SETUPE1

Enter Setup

41 is the hex value for A (character in the replacement string)

42 is the hex value for B (character in the replacement string)

43 is the hex value for C (character in the replacement string)

F1 is the "Send all characters" command

00 is the hex value for a NUL

The data is output as: **1ABC4AbcABCR01ABCU**

BA Example: Remove only the first occurrence of "23"s in barcode data

If the barcode has a string of characters that the host application wants removed, you can use the BA command to replace the string with NUL. In this example, you will remove the first occurrence of "23" in the barcode above.

Command string: **BA0102323300F100**

BA is the "Replace a string with another" command

01 is the count of replacements to be made

02 is the length of the string to be replaced

32 is the hex value for 2 (character in the string to be replaced)

33 is the hex value for 3 (character in the string to be replaced)

00 is the length of the replacement string, 00 means to replace the string to be replaced with NUL

F1 is the "Send all characters" command

00 is the hex value for a NUL

The data is output as: **14Abc23R0123U**



@SETUPE0

** Exit Setup



@SETUPE1

Enter Setup

EF Insert a delay

Syntax=EFnnnn (nnnn: The delay in 5ms increments, up to 9999)

Inserts a delay of up to 49,995 milliseconds (in multiples of 5), starting from the current cursor position. This command can only be used with USB HID Keyboard.

EF Example: Insert a delay of 1s between the 5th and 6th character

Send the first 5 characters in a barcode, wait for 1s, then send the rest of the barcode data.

Command string: **F20500EF0200E900**

F2 is the "Send a number of characters" command

05 is the number of characters to send

00 is the hex value for a Null character

EF is the "Insert a delay" command

0200 is the delay value (5msX200=1000ms=1s)

E9 is the "Send all but the last characters" command

00 is the number of characters that will not be sent at the end of the message



@SETUPE0

** Exit Setup



@SETUPE1

Enter Setup

B5 Insert key strokes

Syntax=B5nnssxx (nn: The number of keys pressed (without key modifiers); ss: the key modifier from the table below; xx: the key number from the “Unicode Key Maps” in Appendix.)

Insert a key stroke or combination of key strokes. Key strokes are dependent on your keyboard (see the “Unicode Key Maps” in Appendix). This command can only be used with USB HID Keyboard.

Key Modifiers	
No Key Modifier	00
Shift Left	01
Shift Right	02
Alt Left	04
Alt Right	08
Control Left	10
Control Right	20

For example, B501001F inserts an “a” on a U.S. style keyboard. B5 = the command, 01 = number of keys pressed (without the key modifier), 00 is No Key Modifier, and 1F is the “a” key. If an “A” were to be inserted, B501011F or B501021F would be entered.

If there are two keystrokes, the syntax would change from Syntax=B5nnssxx for one keystroke to Syntax=B5nnssxxssxx. An example that would insert “aA” is as follows: B502001F011F.

Note: Key modifiers can be added together when needed. Example: Shift Left + Alt Left + Control Left =15.



@SETUPE0

** Exit Setup



@SETUPE1

Enter Setup

Chapter 8 Prefix&Suffix

Introduction

A 1D barcode could contain digits, letters, symbols, etc. A 2D barcode could contain more data, such as Chinese characters and other multi-byte characters. However, in real applications, they do not and should not have all information we need, such as barcode type, data acquisition time and delimiter, in order to keep the barcodes short and flexible.

Prefix and suffix are how to fulfill the needs mentioned above. They can be added, removed and modified while the original barcode data remains intact.



Barcode processing procedure:

1. Edit data with Data Formatter
2. Append prefix/suffix
3. Pack data
4. Append terminating character



@SETUPE0

**** Exit Setup**



@SETUPE1

Enter Setup

Global Settings

Enable/Disable All Prefixes/Suffixes

Disable All Prefixes/Suffixes: Transmit barcode data with no prefix/suffix.

Enable All Prefixes/Suffixes: Allow to append Code ID prefix, AIM ID prefix, custom prefix/suffix and terminating character to the barcode data before the transmission.



@APSENA0

Disable All Prefixes/Suffixes



@APSENA1

Enable All Prefixes/Suffixes

Prefix Sequence



@PRESEQ0

**** Code ID+ Custom +AIM ID**



@PRESEQ1

Custom + Code ID + AIM ID



@SETUPE0

**** Exit Setup**



@SETUPE1
Enter Setup

Custom Prefix

Enable/Disable Custom Prefix

If custom prefix is enabled, you are allowed to append to the data a user-defined prefix that cannot exceed 10 characters. For example, if the custom prefix is “AB” and the barcode data is “123”, the Host will receive “AB123”.



@CPRENA0
**** Disable Custom Prefix**



@CPRENA1
Enable Custom Prefix

Set Custom Prefix

To set a custom prefix, scan the **Set Custom Prefix** barcode then the numeric barcodes corresponding to the hexadecimal value of a desired prefix then the **Save** barcode.

Note: A custom prefix cannot exceed 10 characters.



@CPRSET
Set Custom Prefix

Set the custom prefix to “CODE” (HEX: 0x43/0x4F/0x44/0x45):

E
example

1. Scan the **Enter Setup** barcode.
2. Scan the **Set Custom Prefix** barcode.
3. Scan the numeric barcodes “4”, “3”, “4”, “F”, “4”, “4”, “4” and “5” from the “Digit Barcodes” section in Appendix.
4. Scan the **Save** barcode from the “Save/Cancel Barcodes” section in Appendix.
5. Scan the **Enable Custom Prefix** barcode.
6. Scan the **Exit Setup** barcode.



@SETUPE0
**** Exit Setup**



@SETUPE1

Enter Setup

AIM ID Prefix

AIM (Automatic Identification Manufacturers) ID defines symbology identifier (For the details, see the “AIM ID Table” section in Appendix). If AIM ID prefix is enabled, the scanner will add the symbology identifier before the scanned data after decoding.



@AIDENA0

**** Disable AIM ID Prefix**



@AIDENA1

Enable AIM ID Prefix



AIM ID is not user programmable.



@SETUPE0

**** Exit Setup**



@SETUPE1

Enter Setup

Code ID Prefix

Code ID can also be used to identify barcode type. Unlike AIM ID, Code ID is user programmable. Code ID can only consist of one or two English letters.



@CIDENA0

**** Disable Code ID Prefix**



@CIDENA1

Enable Code ID Prefix

Restore All Default Code IDs

For the information of default Code IDs, see the “Code ID Table” section in Appendix.



@CIDDEF

Restore All Default Code IDs

Modify Code ID

See the examples below to learn how to modify a Code ID and restore the default Code IDs of all symbologies.



@SETUPE0

**** Exit Setup**



@SETUPE1

Enter Setup

E *sample*

Modify PDF417 Code ID to be “p” (HEX: 0x70):

1. Scan the **Enter Setup** barcode.
2. Scan the **Modify PDF417 Code ID** barcode.
3. Scan the numeric barcodes “7” and “0” from the “Digit Barcodes” section in Appendix.
4. Scan the **Save** barcode from the “Save/Cancel Barcodes” section in Appendix.
5. Scan the **Exit Setup** barcode.

Restore the default Code IDs of all symbologies:

1. Scan the **Enter Setup** barcode.
2. Scan the **Restore All Default Code IDs** barcode.
3. Scan the **Exit Setup** barcode.



@SETUPE0

**** Exit Setup**



@SETUPE1

Enter Setup

1D symbologies:



@CID002

Modify Code 128 Code ID



@CID003

Modify GS1-128 Code ID



@CID004

Modify EAN-8 Code ID



@CID005

Modify EAN-13 Code ID



@CID006

Modify UPC-E Code ID



@CID007

Modify UPC-A Code ID



@CID008

Modify Interleaved 2 of 5 Code ID



@SETUPE0

**** Exit Setup**



@SETUPE1

Enter Setup



@CID009

Modify ITF-14 Code ID



@CID010

Modify ITF-6 Code ID

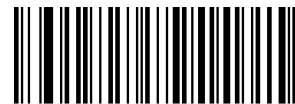

@CID011

Modify Matrix 2 of 5 Code ID



@CID013

Modify Code 39 Code ID



@CID015

Modify Codabar Code ID



@CID017

Modify Code 93 Code ID



@CID019

Modify China Post 25 Code ID



@CID020

Modify AIM 128 Code ID



@SETUPE0

**** Exit Setup**



@SETUPE1

Enter Setup



@CID021

Modify ISBT 128 Code ID



@CID023

Modify ISSN Code ID



@CID024

Modify ISBN Code ID



@CID025

Modify Industrial 25 Code ID



@CID026

Modify Standard 25 Code ID



@CID027

Modify Plessey Code ID



@CID028

Modify Code 11 Code ID



@CID029

Modify MSI-Plessey Code ID



@SETUPE0

**** Exit Setup**



@SETUPE1

Enter Setup



@CID030

Modify GS1 Composite Code ID

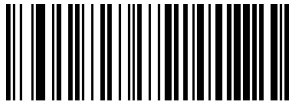

@CID031

Modify GS1 Databar Code ID



@CID132

Modify Code 49 Code ID



@CID133

Modify Code 16K Code ID



@SETUPE0

**** Exit Setup**



@SETUPE1

Enter Setup

2D symbologies:



@CID032

Modify PDF417 Code ID



@CID033

Modify QR Code ID



@CID034

Modify Aztec Code ID



@CID035

Modify Data Matrix Code ID



@CID036

Modify Maxicode Code ID



@CID039

Modify Chinese Sensible Code ID



@CID041

Modify GM Code ID



@SETUPE0

**** Exit Setup**



@SETUPE1

Enter Setup



@CID042

Modify Micro PDF417 Code ID



@CID043

Modify Micro QR Code ID

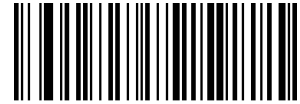

@CID048

Modify Code One Code ID



@SETUPE0

**** Exit Setup**



@SETUPE1

Enter Setup

Postal symbologies:



@CID096

Modify USPS Postnet Code ID



@CID098

Modify Royal Mail Code ID



@CID100

Modify KIX Post Code ID



@CID097

Modify USPS Intelligent Mail Code ID

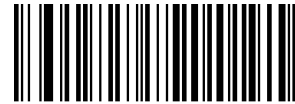

@CID099

Modify USPS Planet Code ID



@CID101

Modify Australian Postal Code ID



@SETUPE0

**** Exit Setup**



@SETUPE1

Enter Setup

Custom Suffix

Enable/Disable Custom Suffix

If custom suffix is enabled, you are allowed to append to the data a user-defined suffix that cannot exceed 10 characters. For example, if the custom suffix is “AB” and the barcode data is “123”, the Host will receive “123AB”.



@CSUENA0

** Disable Custom Suffix



@CSUENA1

Enable Custom Suffix

Set Custom Suffix

To set a custom suffix, scan the **Set Custom Suffix** barcode then the numeric barcodes corresponding to the hexadecimal value of a desired suffix then the **Save** barcode.

Note: A custom suffix cannot exceed 10 characters.



@CSUSET

Set Custom Suffix

E
sample

Set the custom suffix to “CODE” (HEX: 0x43/0x4F/0x44/0x45):

1. Scan the **Enter Setup** barcode.
2. Scan the **Set Custom Suffix** barcode.
3. Scan the numeric barcodes “4”, “3”, “4”, “F”, “4”, “4”, “4” and “5” from the “Digit Barcodes” section in Appendix.
4. Scan the **Save** barcode from the “Save/Cancel Barcodes” section in Appendix.
5. Scan the **Enable Custom Suffix** barcode.
6. Scan the **Exit Setup** barcode.



@SETUPE0

** Exit Setup



@SETUPE1

Enter Setup

Data Packing

Introduction

Data packing is designed for a specific group of users who want to have the data packed before transmission. Data packing influences data format, so it is advised to disable this feature when it is not required.

Data Packing Options

Disable Data Packing: Transmit decoded data in raw format (unpacked).

Enable Data Packing, Format 1: Transmit decoded data with the packet format 1 defined below.

Packet format 1: [STX + ATTR + LEN] + [AL_TYPE + DATA] + [LRC]

STX: 0x02

ATTR: 0x00

LEN: Barcode data length is expressed in 2 bytes ranging from 0x0000 (0) to 0xFFFF (65535).

AL_TYPE: 0x36

DATA: Raw barcode data.

LRC: Check digit.

LRC calculation algorithm: computation sequence: 0xFF+LEN+AL_TYPE+DATA; computation method is XOR, byte by byte.

Enable Data Packing, Format 2: Transmit decoded data with the packet format 2 defined below.

Packet format 2: [STX + ATTR + LEN] + [AL_TYPE] + [Symbology_ID + DATA] + [LRC]

STX: 0x02

ATTR: 0x00

LEN: Barcode data length is expressed in 2 bytes ranging from 0x0000 (0) to 0xFFFF (65535).

AL_TYPE: 0x3B

Symbology_ID: The ID number of symbology, 1 byte.

DATA: Raw barcode data.

LRC: Check digit.

LRC calculation algorithm: computation sequence: 0xFF+LEN+AL_TYPE+Symbology_ID+DATA; computation method is XOR, byte by byte.



@SETUPE0

** Exit Setup



@SETUPE1

Enter Setup



@PACKAG0

**** Disable Data Packing**



@PACKAG2

Enable Data Packing, Format 2



@PACKAG1

Enable Data Packing, Format 1



@SETUPE0

**** Exit Setup**



@SETUPE1

Enter Setup

Terminating Character Suffix

Enable/Disable Terminating Character Suffix

A terminating character such as carriage return (CR) or carriage return/line feed pair (CRLF) can only be used to mark the end of data, which means nothing can be added after it.



@TSUENAO

Disable Terminating Character Suffix



@TSUENA1

**** Enable Terminating Character Suffix**

Set Terminating Character Suffix

To set a terminating character suffix, scan the **Set Terminating Character Suffix** barcode then the numeric barcodes corresponding to the hexadecimal value of a desired terminating character then the **Save** barcode.

Note: A terminating character suffix cannot exceed 2 characters.



@TSUSET

Set Terminating Character Suffix

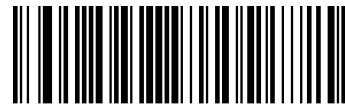

@TSUSET0D

**** Set Terminating Character to CR (0x0D)**



@TSUSET0D0A

Set Terminating Character to CRLF (0x0D,0x0A)



@SETUPE0

**** Exit Setup**



@SETUPE1

Enter Setup

E
sample

Set the terminating character suffix to 0x0A:

1. Scan the **Enter Setup** barcode.
2. Scan the **Set Terminating Character Suffix** barcode.
3. Scan the numeric barcodes "0" and "A" from the "Digit Barcodes" section in Appendix.
4. Scan the **Save** barcode from the "Save/Cancel Barcodes" section in Appendix.
5. Scan the **Enable Terminating Character Suffix** barcode.
6. Scan the **Exit Setup** barcode.



@SETUPE0

**** Exit Setup**



@SETUPE1
Enter Setup

Chapter 9 Batch Programming

Introduction

Batch programming enables users to integrate a batch of commands into a single batch barcode.

Listed below are batch programming rules:

1. Command format: Command + Parameter Value.
2. Each command is terminated by a semicolon (;). Note that there is no space between a command and its terminator semicolon.
3. Use the barcode generator software to generate a 2D batch barcode.

Example: Create a batch barcode for **Normal Illumination, Sense Mode, Decode Session Timeout = 2s, Disable Interleaved 2 of 5:**

1. Input the commands:

@ILLSCN1;SCNMOD2;ORTSET2000;I25ENA0;

2. Generate a batch barcode.

When setting up a scanner with the above configuration, scan the **Enable Batch Barcode** barcode and then the batch barcode generated.



@BATCHS
Enable Batch Barcode



@SETUPE0
** Exit Setup



@SETUPE1

Enter Setup

Create a Batch Command

A batch command may contain a number of individual commands each of which is terminated by a semicolon (;). For more information, refer to the “Use of Programming Command” section in Chapter 3.

Create a Batch Barcode

Batch barcodes can be produced in the format of PDF417, QR Code or Data Matrix.

Example: Create a batch barcode for **Normal Illumination, Sense Mode, Decode Session Timeout = 2s, Disable Interleaved 2 of 5**:

1. Input the following commands:

```
@ILLSCN1;SCNMOD2;ORTSET2000;I25E
```

```
NA0;
```

2. Generate a PDF417 batch barcode.



@SETUPE0

** Exit Setup



Use Batch Barcode

To put a batch barcode into use, scan the following barcodes. (Use the example above.)

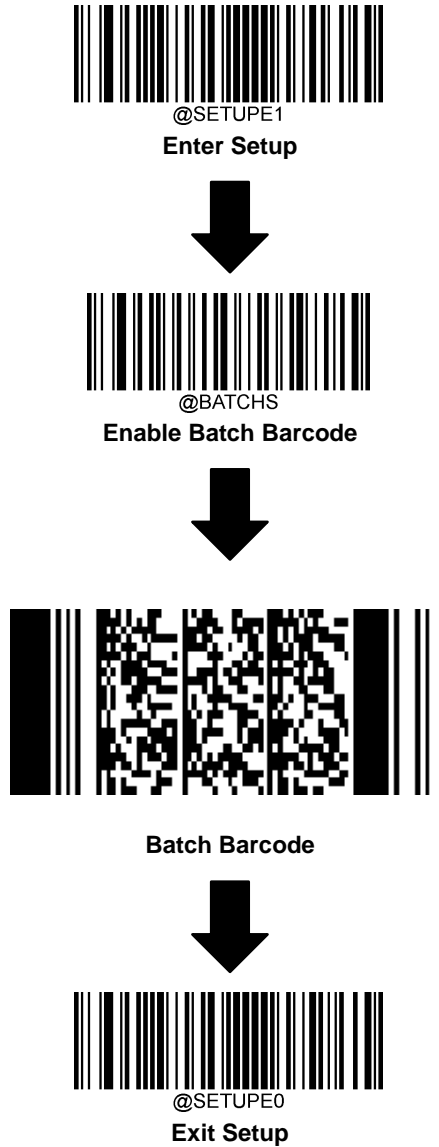

Appendix

Digit Barcodes

0~9





@DIGIT6

6



@DIGIT7

7

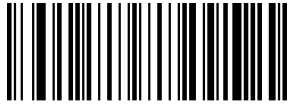

@DIGIT8

8

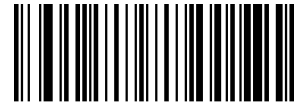

@DIGIT9

9

A~F



Save/Cancel Barcodes

After reading numeric barcode(s), you need to scan the **Save** barcode to save the data. If you scan the wrong digit(s), you can either scan the **Cancel** barcode and then start the configuration all over again, or scan the **Delete the Last Digit** barcode and then the correct digit, or scan the **Delete All Digits** barcode and then the digits you want.

For instance, after reading the **Maximum Length** barcode and numeric barcodes “1”, “2” and “3”, you scan:

- ❖ **Delete the Last Digit:** The last digit “3” will be removed.
- ❖ **Delete All Digits:** All digits “123” will be removed.
- ❖ **Cancel:** The maximum length configuration will be cancelled. And the scanner is still in the setup mode.



Factory Defaults Table

Parameter	Factory Default	Remark
Barcode Programming	Disabled (Exit Setup)	
Programming Barcode Data	Do not transmit	
Illumination	On	
Aiming	Normal	
Good Read LED	On	
Good Read LED Duration	Short (20ms)	
Power On Beep	On	
Good Read Beep	On	
Good Read Beep Duration	Medium (80ms)	
Good Read Beep Frequency	Medium (2730Hz)	
Good Read Beep Volume	Loud	
Do Not Disturb Mode	Turn Off	
Turn On/Off Do Not Disturb Mode by Trigger	Turn Off	
Scan Mode	Level Mode	
Decode Session Timeout	3,000ms	1-3,600,000ms; 0: Infinite
Image Stabilization Timeout (Sense Mode)	200ms	0-3,000ms
Reread Timeout	Disabled	
Image Stabilization Timeout (Sense Mode)	1,500ms	1-3,600,000ms
Reset Reread Timeout	Off	
Image Decoding Timeout	500ms	1-3,000ms
Image Decoding Preference	Paper Barcodes	
Surround GS1 AI's with Parentheses	Off	
Transmit GS1 check character	Enable	
Sensitivity	Medium (11)	
Scanning Preference	Normal Mode	
Read Barcode	On	
Smart Stand Mode	On	
Decode Area	Whole Area Decoding	
Image Flipping	Do Not Flip	
Bad Read Message	Off	
Send Bad Read Message	NG	1-7 characters
Auto Power-Off Timeout	5 minutes	

Wireless Communications		
Operating Mode	Bluetooth Dongle KBW	
Batch Mode Option	Off	
Prevent Same Barcode Storage	Off	
Batch Mode Transmit Delay	No Transmit Delay (0ms)	
End of Transmission Message	Off, EOT	
Auto Clear Stored Data after Transmission	Off	
Wireless Communication Mode	Point-to-Point Mode	
Scanner Time	Set Date and Time	
Time Stamp	Do Not Send	
Time Stamp Format	Format 1: (YYYY/MM/DD,HH:MM:SS)	
Bluetooth Dongle		
USB Country Keyboard	US keyboard	USB HID Keyboard
Emulate ALT+Keypad	Off	USB HID Keyboard
Code Page	Code Page 1252 (West European Latin)	USB HID Keyboard
Function Key Mapping	Disable	USB HID Keyboard
Inter-Keystroke Delay	No Delay	USB HID Keyboard
Caps Lock	Off	
Convert Case	No Case Conversion	USB HID Keyboard
Emulate Numeric Keypad 1	Off	USB HID Keyboard
Emulate Numeric Keypad 2	Off	USB HID Keyboard
Polling Rate	4ms	USB HID Keyboard
Bluetooth Dongle KBW Communication	On	
Symbologies		
Global Settings		
Surround GS1 AI's with Parentheses	Do Not Surround GS1 AI's with Parentheses	

Code 128		
Code 128	Enabled	
Maximum Length	48	
Minimum Length	1	
EAN-8		
EAN-8	Enabled	
Check Character	Transmit	
2-Digit Add-On Code	Disabled	
5-Digit Add-On Code	Disabled	
Add-on Code	Not Required	
Convert EAN-8 to EAN-13	Disabled	
EAN-13		
EAN-13	Enabled	
Check Character	Transmit	
2-Digit Add-On Code	Disabled	
5-Digit Add-On Code	Disabled	
Add-On Code	Not Required	
EAN-13 Beginning with 290 Add-On Code Required	Do Not Require Add-On Code	
EAN-13 Beginning with 378/379 Add-On Code Required	Do Not Require Add-On Code	
EAN-13 Beginning with 414/419 Add-On Code Required	Do Not Require Add-On Code	
EAN-13 Beginning with 434/439 Add-On Code Required	Do Not Require Add-On Code	
EAN-13 Beginning with 977 Add-On Code Required	Do Not Require Add-On Code	
EAN-13 Beginning with 978 Add-On Code Required	Do Not Require Add-On Code	
EAN-13 Beginning with 979 Add-On Code Required	Do Not Require Add-On Code	
UPC-E		
UPC-E0	Enabled	
UPC-E1	Disabled	
Check Character	Transmit	
2-Digit Add-On Code	Disabled	

5-Digit Add-On Code	Disabled	
Add-on Code	Not Required	
Transmit Preamble Character	No Preamble	
Convert UPC-E to UPC-A	Disabled	
UPC-A		
UPC-A	Enabled	
Check Character	Transmit	
2-Digit Add-On Code	Disabled	
5-Digit Add-On Code	Disabled	
Transmit Preamble Character	System Character	
Coupon		
UPC-A/EAN-13 with Extended Coupon Code	Disabled	
Coupon GS1 DataBar Output	Disabled	
Interleaved 2 of 5		
Interleaved 2 of 5	Enabled	
Maximum Length	80	
Minimum Length	6	
Check Character Verification	Do not transmit check digit after verification	
Febraban		
Febraban	Enabled, do not expand	
Transmit Delay per Character	Disabled	
	70ms	
Transmit Delay per 12 Characters	Disabled	
	500ms	
ITF-14		
ITF-14	Disabled	
ITF-6		
ITF-6	Disabled	
Matrix 2 of 5		
Matrix 2 of 5	Enabled	
Maximum Length	80	
Minimum Length	4	
Check Character Verification	Disabled	
Code 39		
Code 39	Enabled	

Maximum Length	48	
Minimum Length	1	
Check Character Verification	Disabled	
Start/Stop Character	Do not transmit	
Code 39 Full ASCII	Disabled	
Code 32 Pharmaceutical (PARAF)	Disabled	
Code 32 Prefix	Disabled	
Code 32 Start/Stop Character	Do not transmit	
Code 32 Check Character	Do not transmit	
Codabar		
Codabar	Enabled	
Maximum Length	60	
Minimum Length	2	
Check Character Verification	Disabled	
Start/Stop Character	Do not transmit	
	ABCD/ABCD	
Code 93		
Code 93	Enabled	
Maximum Length	48	
Minimum Length	1	
Check Character Verification	Do Not Transmit Check Character After Verification	
China Post 25		
China Post 25	Disabled	
Maximum Length	48	
Minimum Length	1	
Check Character Verification	Disabled	
GS1-128 (UCC/EAN-128)		
GS1-128	Enabled	
Maximum Length	48	
Minimum Length	1	
GS1 Databar		
GS1 Databar	Enabled	
Application Identifier "01"	Transmit	
EAN•UCC Composite		
GS1 Composite	Disabled	

UPC/EAN Composite	Disabled	
Code 11		
Code 11	Enabled	
Maximum Length	48	
Minimum Length	4	
Check Character Verification	One Check Character, MOD11	
Check Character	Transmit	
ISBN		
ISBN	Disabled	
Set ISBN Format	ISBN-10	
ISSN		
ISSN	Disabled	
Industrial 25		
Industrial 25	Enabled	
Maximum Length	48	
Minimum Length	6	
Check Character Verification	Disabled	
Standard 25		
Standard 25	Enabled	
Maximum Length	48	
Minimum Length	6	
Check Character Verification	Disabled	
Plessey		
Plessey	Disabled	
Maximum Length	48	
Minimum Length	4	
Check Character Verification	Disabled	
MSI-Plessey		
MSI-Plessey	Disabled	
Maximum Length	48	
Minimum Length	4	
Check Character Verification	One Check Character, MOD10	
Check Character	Transmit	
AIM 128		
AIM 128	Enabled	

Maximum Length	48	
Minimum Length	1	
ISBT 128		
ISBT 128	Disabled	
Code 49		
Code 49	Disabled	
Maximum Length	80	
Minimum Length	1	
Code 16K		
Code 16K	Disabled	
Maximum Length	80	
Minimum Length	1	
PDF417		
PDF417	Enabled	
Maximum Length	2710	
Minimum Length	1	
PDF417 Twin Code	Single PDF417 Only	
PDF417 Inverse	Decode Regular PDF417 Barcodes Only	
Character Encoding	Default Character Encoding	
PDF417 ECI Output	Enabled	
Micro PDF417		
Micro PDF417	Disabled	
Maximum Length	366	
Minimum Length	1	
QR Code		
QR Code	Enabled	
Maximum Length	7089	
Minimum Length	1	
QR Twin Code	Single QR Only	
QR Inverse	Decode Regular QR Barcodes Only	
Character Encoding	Default Character Encoding	
QR ECI Output	Enabled	
Micro QR Code		
Micro QR	Enabled	
Maximum Length	35	
Minimum Length	1	

Aztec		
Aztec Code	Disabled	
Maximum Length	3832	
Minimum Length	1	
Read Multi-barcodes on an Image	Mode 1	
Set the Number of Barcodes	1	
Character Encoding	Default Character Encoding	
Aztec ECI Output	Enabled	
Data Matrix		
Data Matrix	Enabled	
Maximum Length	3116	
Minimum Length	1	
Data Matrix Twin Code	Single Data Matrix Only	
Rectangular Barcode	Enabled	
Data Matrix Inverse	Decode Regular Data Matrix Barcodes Only	
Character Encoding	Default Character Encoding	
Data Matrix ECI Output	Enabled	
Maxicode		
Maxicode	Disabled	
Maximum Length	150	
Minimum Length	1	
Chinese Sensible Code		
Chinese Sensible Code	Disabled	
Maximum Length	7827	
Minimum Length	1	
Chinese Sensible Twin Code	Single Chinese Sensible Code Only	
Chinese Sensible Code Inverse	Decode Regular Chinese Sensible Barcodes Only	
GM Code		
GM	Disabled	
Maximum Length	2751	
Minimum Length	1	
Code One		
Code One	Disabled	
Maximum Length	3550	
Minimum Length	1	
USPS Postnet		

USPS Postnet	Disabled	
Check Character	Transmit	
USPS Intelligent Mail		
USPS Intelligent Mail	Disabled	
Royal Mail		
Royal Mail	Disabled	
USPS Planet		
USPS Planet	Disabled	
Check Character	Transmit	
KIX Post		
KIX Post	Disabled	
Australian Postal		
Australian Postal	Disabled	
Passport OCR		
Passport OCR	Disabled	
Data Formatter		
Data Formatter	Disabled	
Non-Match Error Beep	On	
Data Format Selection	Format_0	
Prefix & Suffix		
All Prefixes/Suffixes	Disabled	
Prefix Sequence	Code ID+ Custom +AIM ID	
Custom Prefix	Disabled	
AIM ID Prefix	Disabled	
Code ID Prefix	Disabled	
Custom Suffix	Disabled	
Data Packing	Disable Data Packing	
Terminating Character Suffix	Enabled, 0x0D (Carriage Return)	

AIM ID Table

Symbology	AIM ID	Possible AIM ID Modifiers (m)
Code 128]C0	
GS1-128 (UCC/EAN-128)]C1	
EAN-8]E4	
EAN-8 with Addon]E3	
EAN-13]E0	
EAN-13 with Addon]E3	
UPC-E]E0	
UPC-E with Addon]E3	
UPC-A]E0	
UPC-A with Addon]E3	
Interleaved 2 of 5, Febraban]Im	0, 1, 3
ITF-14]Im	1, 3
ITF-6]Im	1, 3
Matrix 2 of 5]X0	
Code 39, Code 32]Am	0, 1, 3, 4, 5, 7
Codabar]Fm	0, 2, 4
Code 93]G0	
China Post 25]X0	
AIM 128]C2	
ISBT 128]C4	
ISSN]X0	
ISBN]X0	
Industrial 25]S0	
Standard 25]R0	
Plessey]P0	
Code 11]Hm	0, 1, 3
MSI Plessey]Mm	0, 1
GS1 Composite]em	0-3
GS1 Databar (RSS)]e0	
Code 49]T0	
Code 16K]K0	

Symbology	AIM ID	Possible AIM ID Modifiers (m)
PDF417]Lm	0-2
QR Code]Qm	0-6
Aztec]zm	0-9, A-C
Data Matrix]dm	0-6
Maxicode]Um	0-3
Chinese Sensible Code]X0	
GM]gm	(0~9)
Micro PDF417]L0	
Micro QR]Q1	
Code One]X0	
USPS Postnet]X0	
USPS Intelligent Mail]X0	
Royal Mail]X0	
USPS Planet]X0	
KIX Post]X0	
Australian Postal]X0	
Passport OCR]o2	

Note: “m” represents the AIM modifier character. Refer to ISO/IEC 15424:2008 Information technology – Automatic identification and data capture techniques – Data Carrier Identifiers (including Symbology Identifiers) for AIM modifier character details.

Code ID Table

Symbology	Code ID
Code 128	j
GS1-128 (UCC/EAN-128)	j
EAN-8	d
EAN-13	d
UPC-E	c
UPC-A	c
Interleaved 2 of 5, Febraban	e
ITF-14	e
ITF-6	e
Matrix 2 of 5	v
Code 39, Code 32	b
Codabar	a
Code 93	i
China Post 25	X
AIM 128	X
ISBT 128	X
ISSN	g
ISBN	B
Industrial 25	l
Standard 25	f
Plessey	n
Code 11	H
MSI Plessey	m
GS1 Composite	y
GS1 Databar (RSS)	R
Code 49	X
Code 16K	X
PDF417	r
QR Code	s
Aztec	z
Data Matrix	u

Symbology	Code ID
MaxiCode	x
Chinese Sensible Code	h
GM Code	x
Micro PDF417	R
Micro QR	X
Code One	X
USPS Postnet	P
USPS Intelligent Mail	M
Royal Mail	x
USPS Planet	L
KIX Post	K
Australian Postal	A
Passport OCR	O

Symbology ID Number

Symbology	ID Number
Code 128	002
GS1-128 (UCC/EAN-128)	003
EAN-8	004
EAN-13	005
UPC-E	006
UPC-A	007
Interleaved 2 of 5, Febraban	008
ITF-14	009
ITF-6	010
Matrix 2 of 5	011
Code 39, Code 32	013
Codabar	015
Code 93	017
China Post 25	019
AIM 128	020
ISBT 128	021
ISSN	023
ISBN	024
Industrial 25	025
Standard 25	026
Plessey	027
Code11	028
MSI-Plessey	029
GS1 Composite	030
GS1 Databar (RSS)	031
PDF417	032
QR Code	033
Aztec	034
Data Matrix	035
Maxicode	036
Chinese Sensible Code	039
GM Code	040

Symbology	ID Number
Micro PDF417	042
Micro QR	043
Code One	048
Passport OCR	066
USPS Postnet	096
USPS Intelligent Mail	097
Royal Mail	098
USPS Planet	099
KIX Post	100
Australian Postal	101
Code 49	132
Code 16K	133

ASCII Table

HEX	Dec	Char
00	0	NUL (Null char.)
01	1	SOH (Start of Header)
02	2	STX (Start of Text)
03	3	ETX (End of Text)
04	4	EOT (End of Transmission)
05	5	ENQ (Enquiry)
06	6	ACK (Acknowledgment)
07	7	BEL (Bell)
08	8	BS (Backspace)
09	9	HT (Horizontal Tab)
0a	10	LF (Line Feed)
0b	11	VT (Vertical Tab)
0c	12	FF (Form Feed)
0d	13	CR (Carriage Return)
0e	14	SO (Shift Out)
0f	15	SI (Shift In)
10	16	DLE (Data Link Escape)
11	17	DC1 (XON) (Device Control 1)
12	18	DC2 (Device Control 2)
13	19	DC3 (XOFF) (Device Control 3)
14	20	DC4 (Device Control 4)
15	21	NAK (Negative Acknowledgment)
16	22	SYN (Synchronous Idle)
17	23	ETB (End of Trans. Block)
18	24	CAN (Cancel)
19	25	EM (End of Medium)
1a	26	SUB (Substitute)
1b	27	ESC (Escape)

1c	28	FS (File Separator)
1d	29	GS (Group Separator)
1e	30	RS (Request to Send)
1f	31	US (Unit Separator)
20	32	SP (Space)
21	33	! (Exclamation Mark)
22	34	" (Double Quote)
23	35	# (Number Sign)
24	36	\$ (Dollar Sign)
25	37	% (Percent)
26	38	& (Ampersand)
27	39	` (Single Quote)
28	40	((Right / Closing Parenthesis)
29	41) (Right / Closing Parenthesis)
2a	42	* (Asterisk)
2b	43	+ (Plus)
2c	44	, (Comma)
2d	45	- (Minus / Dash)
2e	46	. (Dot)
2f	47	/ (Forward Slash)
30	48	0
31	49	1
32	50	2
33	51	3
34	52	4
35	53	5
36	54	6
37	55	7
38	56	8
39	57	9
3a	58	: (Colon)
3b	59	; (Semi-colon)
3c	60	< (Less Than)
3d	61	= (Equal Sign)

3e	62	> (Greater Than)
3f	63	? (Question Mark)
40	64	@ (AT Symbol)
41	65	A
42	66	B
43	67	C
44	68	D
45	69	E
46	70	F
47	71	G
48	72	H
49	73	I
4a	74	J
4b	75	K
4c	76	L
4d	77	M
4e	78	N
4f	79	O
50	80	P
51	81	Q
52	82	R
53	83	S
54	84	T
55	85	U
56	86	V
57	87	W
58	88	X
59	89	Y
5a	90	Z
5b	91	[(Left / Opening Bracket)
5c	92	\ (Back Slash)
5d	93] (Right / Closing Bracket)
5e	94	^ (Caret / Circumflex)
5f	95	_ (Underscore)
60	96	' (Grave Accent)
61	97	a
62	98	b
63	99	c
64	100	d
65	101	e

66	102	f
67	103	g
68	104	h
69	105	i
6a	106	j
6b	107	k
6c	108	l
6d	109	m
6e	110	n
6f	111	o
70	112	p
71	113	q
72	114	r
73	115	s
74	116	t
75	117	u
76	118	v
77	119	w
78	120	x
79	121	y
7a	122	z
7b	123	{ (Left/ Opening Brace)
7c	124	(Vertical Bar)
7d	125	} (Right/Closing Brace)
7e	126	~ (Tilde)
7f	127	DEL (Delete)

Unicode Key Maps

6E	70	71	72	73	74	75	76	77	78	79	7A	7B	7C	7D	7E	•	•	•		
01	02	03	04	05	06	07	08	09	0A	0B	0C	0D	0F	4B	50	55	5A	5F	64	69
10	11	12	13	14	15	16	17	18	19	1A	1B	1C	1D	4C	51	56	5B	60	65	6A
1E	1F	20	21	22	23	24	25	26	27	28	29	2B				5C	61	66		
2C	2E	2F	30	31	32	33	34	35	36	37	39			53			5D	62	67	6C
3A	3B	3C	3D				3E	3F	38	40			4F	54	59	63	68			

104 Key U.S. Style Keyboard

6E	70	71	72	73	74	75	76	77	78	79	7A	7B	7C	7D	7E	•	•	•		
01	02	03	04	05	06	07	08	09	0A	0B	0C	0D	0F	4B	50	55	5A	5F	64	69
10	11	12	13	14	15	16	17	18	19	1A	1B	1C	2B	4C	51	56	5B	60	65	6A
1E	1F	20	21	22	23	24	25	26	27	28	29	1D				5C	61	66		
2C	2D	2E	2F	30	31	32	33	34	35	36	37	39			53		5D	62	67	6C
3A	3B	3C	3D				3E	3F	38	40			4F	54	59	63	68			

105 Key European Style Keyboard



Newland

SCANNING MADE SIMPLE

Newland EMEA HQ

+31 (0) 345 87 00 33
info@newland-id.com
newland-id.com

D-A-CH

0049 (0) 6182 82916-16
info@newland-id.de

Benelux

+31 (0) 345 87 00 33
benelux@newland-id.com

Italy

+39 (0) 342 0562227
italy@newland-id.com

United Kingdom

+44 (0) 7771 631387
sales@newland-id.co.uk

South Africa

Gauteng: +27 (0) 11 553 8010
Cape Town: +27 (0) 21 9140819
info@newland-id.co.za

Turkey

+90 (0) 544 538 40 49
turkey@newland-id.com

France

+39 (0) 345 8804096
france@newland-id.com

Ibérica

+34 (0) 93 303 74 66
info@newland-id.es

Nordic & Baltic

+46 (0) 70 88 47 767
nordic@newland-id.com

Russia

+7 (495) 120-23-85
russia@newland-id.com

Middle East

+39 (0) 345 8804096
middleeast@newland-id.com

Iran

+90 (0) 544 538 40 49
iran@newland-id.com