



eufy SECURITY



## Quick Start Guide

eufy Security Floodlight Camera

Anker Innovations Limited. All rights reserved. eufy Security and eufy Security Logo are trademarks of Anker Innovations Limited, registered in the United States and other countries. All other trademarks are the property of their respective owners.

Model: T8420

51005001400 V02

## Table of Content

What's in the Box	01
Power On the Floodlight Camera Indoors	02
Get the eufy Security App and Setup the Camera	02
Mount Floodlight Camera Outdoors	04
Safety	10
Customer Service	12

## What's in the Box



Floodlight Camera  
(T8420)



Power Cord  
(Connected to the unit)

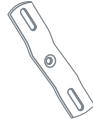

Mounting Plate



Installation Hook



Central Screw



Central Screw Cap



Plate Screws



Install Floodlight Camera to the junction box outdoors (you need to have a junction box and wires already installed).

In order to stream video from Floodlight Camera, you need to make sure the Wi-Fi signal strength is strong at the location you want to install Floodlight Camera.



To avoid risk of shock, injury or death, always be cautious when working with electricity. Remember, do hire a professional electrician if you are uncomfortable working with electrical wiring.

## Power On the Floodlight Camera Indoors

1. Connect Floodlight Camera to a power source, and then wait 1 minute or until the LED indicator blinks red.

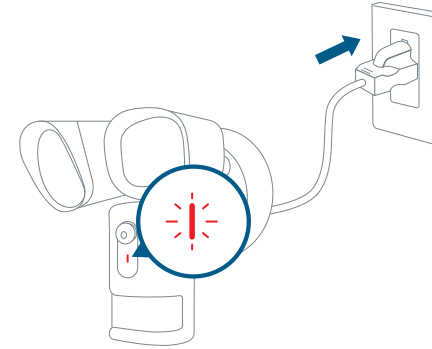

## Get the eufy Security App and Setup the Camera

Download the eufy Security app from the App Store (iOS devices) or Google Play (Android devices).



Login or sign up for a eufy Security account, then follow the onscreen instructions to complete setup.

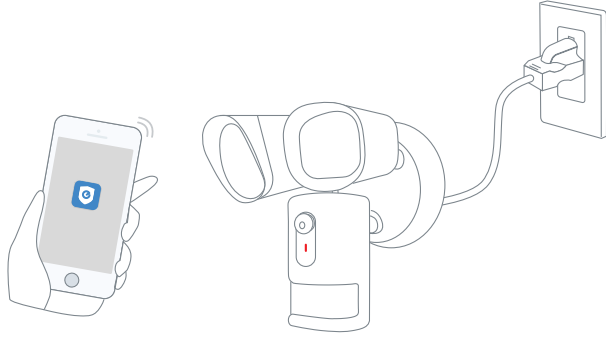

To avoid risk of shock, injury or death, always be cautious when working with electricity.



Make sure you can livestream video from Floodlight Camera before mounting.

## Mount Floodlight Camera Outdoors

### Step 1

Unplug Floodlight Camera.

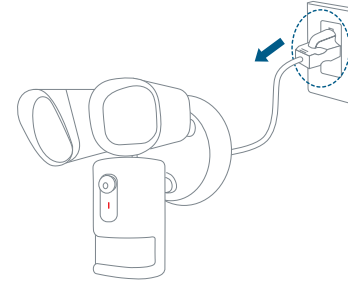

### Step 2

Unscrew the power cord; wire nuts will be used later. The power cord is not required when mounting the Floodlight Camera outdoors.

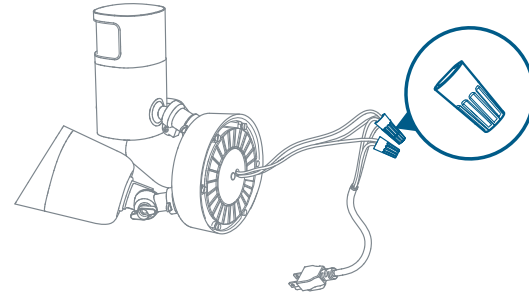

### Step 3

Shut down the circuit breaker in your house. Switch on/off the lights to make sure the electricity in your house is properly shut off.

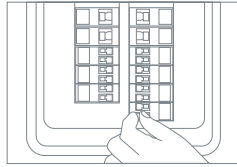

To avoid risk of shock, injury or death, always be cautious when working with electricity.

### Step 4

Remove the old Floodlight from the junction box and install the mounting plate to the junction box.



The junction box and existing electrical wires are required to Floodlight Camera installation.

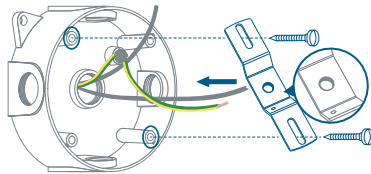

The concaved side of the mounting plate must face outwards.

### Step 5

1. User can hang Floodlight Camera upside down or install it vertically on the wall. Select the installation method that best suits the position of your junction box.

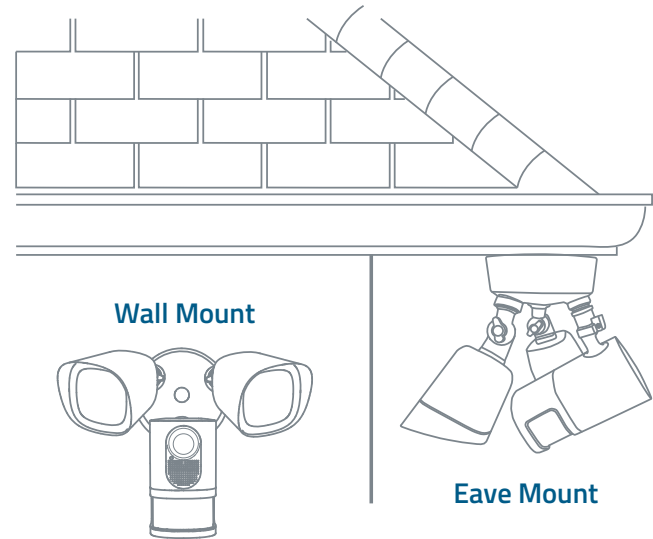

To avoid risk of shock, injury or death, always be cautious when working with electricity. Remember, do hire a professional electrician if you're uncomfortable working with electrical wiring.

If you plan to install the Floodlight Camera on the wall, please skip to Step 6.

2. For upside down installation, turn the camera down to the end when it's placed vertically, then turn the camera 180° in clockwise direction.

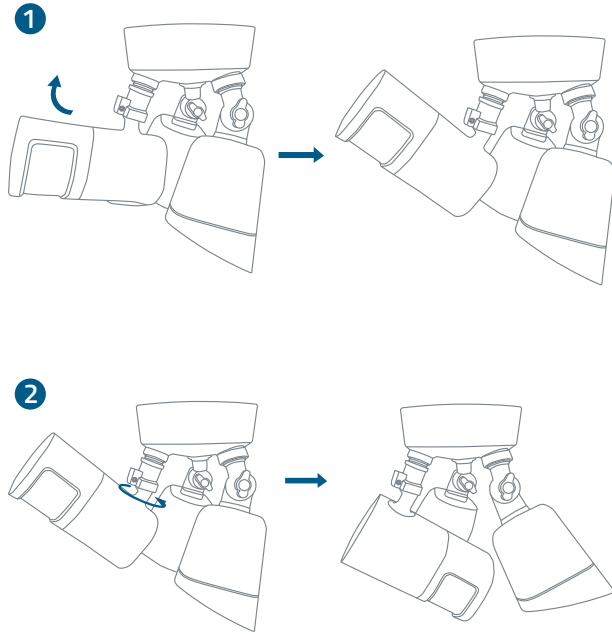

To avoid risk of shock, injury or death, always be cautious when working with electricity. Remember, do hire a professional electrician if you're uncomfortable working with electrical wiring.

## Step 6

1. Hang Floodlight Camera on the junction box with the hook provided.

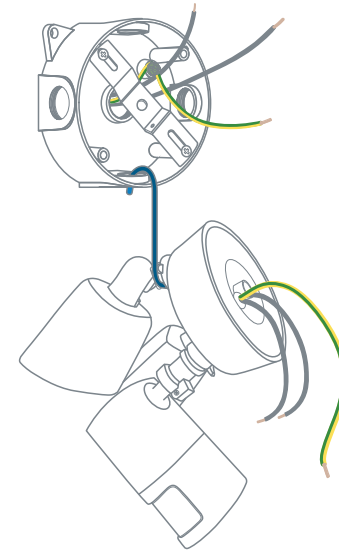

To avoid risk of shock, injury or death, always be cautious when working with electricity. Remember, do hire a professional electrician if you're uncomfortable working with electrical wiring.

2. Connect both ground wires(yellow or green) from the junction box and Floodlight Camera, join the wires by using a wire nut.  
If the existing ground wire has been connected to the junction box or there's no ground wire, connect the ground wire of the Floodlight Camera to the junction box or mounting plate directly.

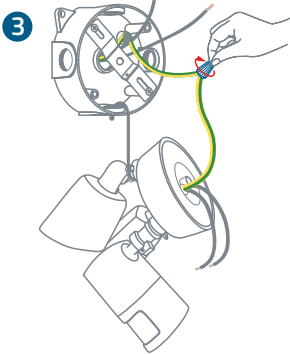
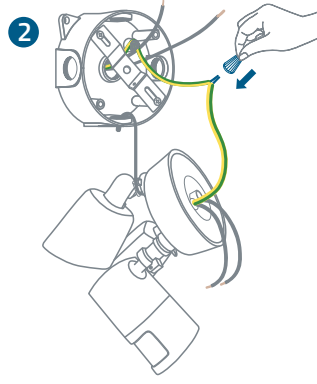
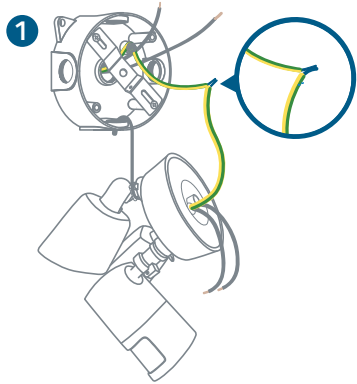

To avoid risk of shock, injury or death, always be cautious when working with electricity. Remember, do hire a professional electrician if you're uncomfortable working with electrical wiring.

3. Use wire nuts to connect Floodlight Camera wires to the rest of the wires from junction box. Connect the white wire on the Floodlight Camera to the white wire(neutral) from junction box. Connect the black wire on the Floodlight Camera to the black wire(hot) from junction box.

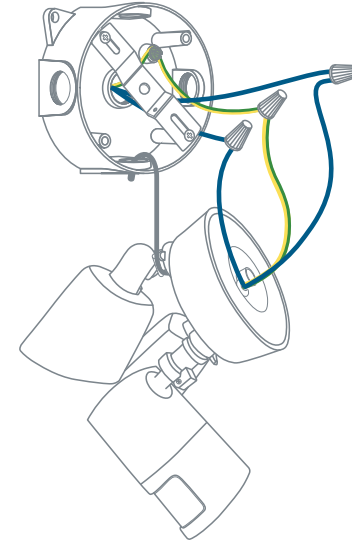

To avoid risk of shock, injury or death, always be cautious when working with electricity. Remember, do hire a professional electrician if you're uncomfortable working with electrical wiring.

## Step 7

Insert the central screw through the center of Floodlight Camera and screw it tightly.

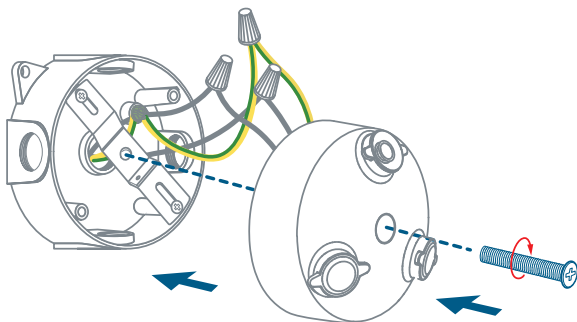

Use the central screw cap to cover the central screw to prevent the central screw from rusting.

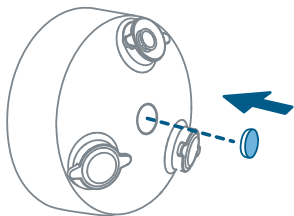

## Step 8

After installation is complete, you can turn the camera knobs on Floodlight Camera to adjust the camera to your desired angle.

## Step 9

Switch on the main circuit breaker in the house. To check whether Floodlight Camera is operating, check if the LED indicator has turned solid white.



In case Floodlight Camera is not powered on, switch off the circuit breaker before checking the wiring of Floodlight Camera.

To avoid risk of shock, injury or death, always be cautious when working with electricity. Remember, do hire a professional electrician if you're uncomfortable working with electrical wiring.

In case Floodlight Camera keeps blinking red, it means the floodlight is not connected to the Internet. Please make sure the Wi-Fi signal is strong at the desired location. You may consider moving the wireless router closer to Floodlight Camera or using a Wi-Fi range extender.

**For troubleshooting, check the Help section in the Eufy Security app.**

**Refer to the app page for what the LED indicator status lights mean.**



# Safety

## FCC Statement

This device complies with Part 15 of the FCC Rules. Operation is subject to the following two conditions: (1) this device may not cause harmful interference, and (2) this device must accept any interference received, including interference that may cause undesired operation.

**Warning:** Changes or modifications not expressly approved by the party responsible for compliance could void the user's authority to operate the equipment.

**Note:** This equipment has been tested and found to comply with the limits for a Class B digital device, pursuant to Part 15 of the FCC Rules. These limits are designed to provide reasonable protection against harmful interference in a residential installation.

This equipment generates uses and can radiate radio frequency energy and, if not installed and used in accordance with the instructions, may cause harmful interference to radio communications. However, there is no guarantee that interference will not occur in a particular installation. If this equipment does cause harmful interference to radio or television reception, which can be determined by turning the equipment off and on, the user is encouraged to try to correct the interference by one or more of the following measures: (1) Reorient or relocate the receiving antenna. (2) Increase the separation between the equipment and receiver. (3) Connect the equipment into an outlet on a circuit different from that to which the receiver is connected. (4) Consult the dealer or an experienced radio/TV technician for help.

## FCC Radio Frequency Exposure Statement

The device has been evaluated to meet general RF exposure requirements. The device can be used in fixed/mobile exposure condition. The min separation distance is 20cm.

**Notice:** Shielded cables

All connections to other computing devices must be made using shielded cables to maintain compliance with FCC regulations.

The following importer is the responsible party

Company Name: POWER MOBILE LIFE, LLC

Address: 400 108th Ave NE Ste 400, Bellevue, WA 98004-5541

Telephone:1-206-383-8247

 This product complies with the radio interference requirements of the European Community.

## Declaration of Conformity

Hereby, Anker Innovations Limited declares that this device is in compliance with the essential requirements and other relevant provisions of Directive 2014/53/EU. For the declaration of conformity, visit the Web site [www.eufylife.com](http://www.eufylife.com)

Due to the used enclosure material, the product shall only be connected to a USB Interface of version 2.0 or higher. The connection to so called power USB is prohibited.

The adapter shall be installed near the equipment and shall be easily accessible.

Do not use the Device in the environment at too high or too low temperature, never expose the Device

13

under strong sunshine or too wet environment.

The suitable temperature for the product and accessories is -20°C-50°C.

When charging, please place the device in an environment that has a normal room temperature and good ventilation.

It is recommended to charge the device in an environment with a temperature that ranges from 5°C-25°C. Please ensure to use only the charger offered by the manufacturer. Using unauthorized charger may cause danger and violate the authorization of the projector and the guarantee article.

This charger is for indoor use only

The charger output voltage/current is 5Vdc/2A. The plug considered as disconnect device of adapter.RF exposure information: The Maximum Permissible Exposure (MPE) level has been calculated based on a distance of d=20 cm between the device and the human body. To maintain compliance with RF exposure requirement, use product that maintain a 20cm distance between the device and human body.

CAUTION RISK OF EXPLOSION IF BATTERY IS REPLACED BY AN INCORRECT TYPE. DISPOSE OF USED BATTERIES ACCORDING TO THE INSTRUCTIONS

Wi-Fi Operating Frequency Range:2412~2472MHz for EU;

 This product is designed and manufactured with high quality materials and components, which can be recycled and reused.

 This symbol means the product must not be discarded as household waste, and should be delivered

to an appropriate collection facility for recycling. Proper disposal and recycling helps protect natural resources, human health and the environment. For more information on disposal and recycling of this product, contact your local municipality, disposal service, or the shop where you bought this product.

This device complies with Industry Canada licence-exempt RSS standard(s). Operation is subject to the following two conditions:

- (1) this device may not cause interference, and
- (2) this device must accept any interference, including interference that may cause undesired operation of the device."

Le présent appareil est conforme aux CNR d'Industrie Canada applicables aux appareils radio exempts de licence. L'exploitation est autorisée aux deux conditions suivantes:

- (1) l'appareil ne doit pas produire de brouillage, et
- (2) l'utilisateur de l'appareil doit accepter tout brouillage radioélectrique subi, même si le brouillage est susceptible d'en compromettre le fonctionnement!"

This Class B digital apparatus complies with Canadian ICES-003.

Cet appareil numérique de la classe B est conforme à la norme NMB-003 du Canada.

IC RF Statement:

When using the product, maintain a distance of 20cm from the body to ensure compliance with RF exposure requirements.

Lors de l'utilisation du produit, maintenez une distance de 20 cm du corps afin de vous conformer aux exigences en matière d'exposition RF.

FCC ID:2AOKB-T8420 IC:23451-T8420

14

## Customer Service

- **Warranty**

12-month limited warranty

- **Call Us**

United States	+1 (800) 988 7973	Mon-Fri 9AM-5PM (PT)
United Kingdom	+44 (0) 1604 936 200	Mon-Fri 6AM-11AM (GMT)
Germany	+49 (0) 69 9579 7960	Mon-Fri 6:00-11:00

- **Email Us**

Customer Support: [support@eufylife.com](mailto:support@eufylife.com)

 @EufyOfficial

 @EufyOfficial

 eufyofficial