

Smartphone

Xperia PRO-I XQ-BE52/XQ-BE62/XQ-BE72



Use this manual if you encounter any problems, or have any questions about your device.

## Xperia PRO-I features

### Photo Pro (Photography Pro)

[Discover Photo Pro](#)

[BASIC \(Basic\) mode overview](#)

[AUTO/P/S/M mode overview](#)

### Video Pro (Videography Pro)

[Launching Video Pro](#)

[Video Pro Menu](#)

[Video Pro Settings](#)

### Cinema Pro (Cinematography Pro)

[Launching the Cinema Pro app](#)

[Combining clips and watching a film](#)

## Bluetooth remote commander

- └ [Pairing with a Bluetooth remote commander](#)

## External monitor

- └ [Using the External monitor app](#)

## Game enhancer

- └ [Launching the Game enhancer app](#)
- └ [Using the Game enhancer menu](#)
- └ [Setting \[Display & Sound\] in the Game enhancer menu](#)
- └ [Using the camera key as a shortcut key for a Game enhancer actions](#)

## Enhancing the sound

- └ [Enhancing the sound output using 360 Spatial Sound](#)
- └ [Enhancing the sound output using Dolby Atmos®](#)
- └ [Upscaling the quality of compressed music files \(DSEE Ultimate\)](#)
- └ [Reducing wind noise when recording](#)

## Pop-up window

- └ [Using the pop-up window mode](#)

## Split-screen mode

- └ [Using the Split-screen mode](#)

## Dynamic Vibration

- └ [Using Dynamic Vibration](#)
- └ [Adjusting Dynamic Vibration settings](#)

## Ambient display

- └ [Setting the Ambient display](#)

## Shortcut key

- └ [Using the shortcut key](#)

## Side Sense

- └ [Turning Side sense on or off](#)
- └ [Using Side sense](#)
- └ [Setting other Side sense options](#)

## Smart call handling

[Using Smart call handling](#)

## Getting started

[About this Help Guide](#)

[Overview](#)

## Inserting a SIM card and memory card

[Assembly - Dual SIM](#)

[Using a Dual SIM device](#)

[Screen protection](#)

[Starting your device for the first time](#)

[Setting up a Google account on your device](#)

## Transferring content

[Transferring content using the Xperia Transfer 2 app \(from Android/iOS\)](#)

[Synchronizing data using a Google account \(from Android\)](#)

[Transferring content using a computer \(from Android\)](#)

[Transferring content using an SD card \(from Android\)](#)

## Device security

[Making sure your device is protected](#)

[Finding the IMEI number\(s\) of your device](#)

[Finding, locking, or erasing a lost device](#)

## Learning the basics

[Turning the screen on or off](#)

[Home screen](#)

[Adjusting the idle time before the screen turns off](#)

[Smart backlight control](#)

[One-handed mode](#)

[Taking a screenshot](#)

[Recording your device screen](#)

[Alarm](#)

[Scanning QR codes](#)

## [Notification light](#)

---

### Icons in the status bar

- [Status bar and notification panel](#)
- [Status icons](#)
- [Notification icons](#)

## Battery and maintenance

---

### [Charging your device](#)

---

#### Battery and power management

- [Battery Care](#)
- [STAMINA mode](#)
- [Battery and power management](#)
- [Checking battery consumption for applications](#)

#### Updating your device

- [Before updating your device](#)
- [Updating your device wirelessly](#)
- [Updating your device using a computer](#)

#### Restarting, resetting, and repairing

- [Restarting and resetting your device](#)
- [Repairing the device software using Xperia Companion](#)
- [Resetting your applications](#)

#### Improving memory performance

- [Viewing the memory status](#)
- [Freeing up space on the internal storage](#)
- [Stopping applications and services from running](#)
- [Formatting the memory card](#)

## Internet and networks

---

### [Mobile data connection](#)

---

### [Increasing Wi-Fi® signal strength](#)

---

### [Controlling data usage](#)

## Basic settings

### [Settings menu](#)

---

#### Volume, vibration, and sound

- [Volume and vibration](#)

---

- [Sounds and tones](#)

---

### [Screen settings](#)

---

### [Application updates](#)

---

### [Using location services](#)

---

### [Date and time](#)

---

## Photo Pro (Photography Pro)

### BASIC (Basic) mode

- [BASIC \(Basic\) mode overview](#)

---

- [Taking a photo or recording a video](#)

---

- [Viewing photos and videos](#)

---

- [Scanning QR codes](#)

---

- [Frequently used features in the BASIC \(Basic\) mode](#)

---

### Selfies

- [Taking a selfie](#)

---

- [Taking a selfie using Hand shutter](#)

---

### BASIC (Basic) mode settings

- [Color and brightness](#)

---

- [Bokeh effect](#)

---

- [HDR video recording](#)

---

- [Recording a steady video](#)

---

### Using various capturing modes

- [Selecting a capturing mode](#)

---

- [Slow motion videos](#)

---

- [Portrait selfie](#)

---

- [Panorama](#)

---

- [Creative effect](#)

---

## Using the AUTO/P/S/M modes

- [AUTO/P/S/M mode overview](#)
- [Function menu](#)
- [Shooting still images](#)

## Selecting a shooting mode

- [Auto mode \(AUTO\)](#)
- [Program auto \(P\)](#)
- [Shutter speed priority \(S\)](#)
- [Manual exposure \(M\)](#)

## Registering and recalling camera settings

- [Camera settings memory](#)
- [Memory recall \(MR\)](#)

## Selecting a Drive mode (Continuous shooting/Self-timer)

- [Continuous shooting](#)
- [Self-timer](#)

## [Using the flash](#)

## [Scene and condition recognition](#)

## Additional camera settings

- [Setting the focus by touching the viewfinder](#)
- [Face/Eye AF \(still image/video\)](#)
- [Softening the skin tone](#)
- [Tracking an object](#)
- [Setting the Transfer & Tagging add-on mode](#)
- [Data storage](#)
- [Geotagging](#)
- [Grid lines](#)
- [Different ways to use the volume key](#)
- [Audio signals](#)

## Music

### [Transferring music from a computer to your device](#)

[Listening to music](#)

[Music app features](#)

## Connectivity

[Wirelessly mirroring the screen of your device on a TV](#)

[Connecting your device to USB accessories](#)

[NFC \(Near Field Communication\)](#)

[Using your device as a wallet](#)

## Bluetooth® wireless technology

[Turning the Bluetooth function on or off](#)

[Naming your device](#)

[Pairing with another Bluetooth device](#)

[Pairing with a Bluetooth remote commander](#)

[Sending items using Bluetooth technology](#)

[Receiving items using Bluetooth technology](#)

## Support app

[About the Support app](#)

## Notes on use, accessibility, and legal information

[Accessibility](#)

[Using your device in wet and dusty conditions](#)

[Legal information](#)

[Warranty, SAR, and usage guidelines](#)

Smartphone  
Xperia PRO-I XQ-BE52/XQ-BE62/XQ-BE72

## Discover Photo Pro

Photo Pro has two main features, the BASIC (Basic) mode and AUTO/P/S/M modes. With the BASIC (Basic) mode, you can easily take photos and record videos in a manner similar to a regular smartphone camera. With the AUTO/P/S/M modes, you can shoot your ideal images as if using a professional camera.

### BASIC (Basic) mode

Taking advantage of the operability of smartphones, you can easily take photos and record videos by tapping the screen. Lenses can be switched smoothly from super-wide angle to telephoto.

In addition to taking photos with settings automatically adjusted by the camera according to the scene and conditions, you can also use the continuous shooting mode, Bokeh effect, brightness and color adjustment, and more.

The interface switches automatically, so you can use the camera both vertically and horizontally.

### Vertical style



### Horizontal style



### AUTO/P/S/M modes



The AUTO/P/S/M modes have controls that can usually be found on professional cameras. You can select automatic settings or manually control the ISO, shutter speed, white balance, and more. You can also output to the RAW format.



---

## Related Topic

- [BASIC \(Basic\) mode overview](#)
- [AUTO/P/S/M mode overview](#)

## BASIC (Basic) mode overview

### Photo mode

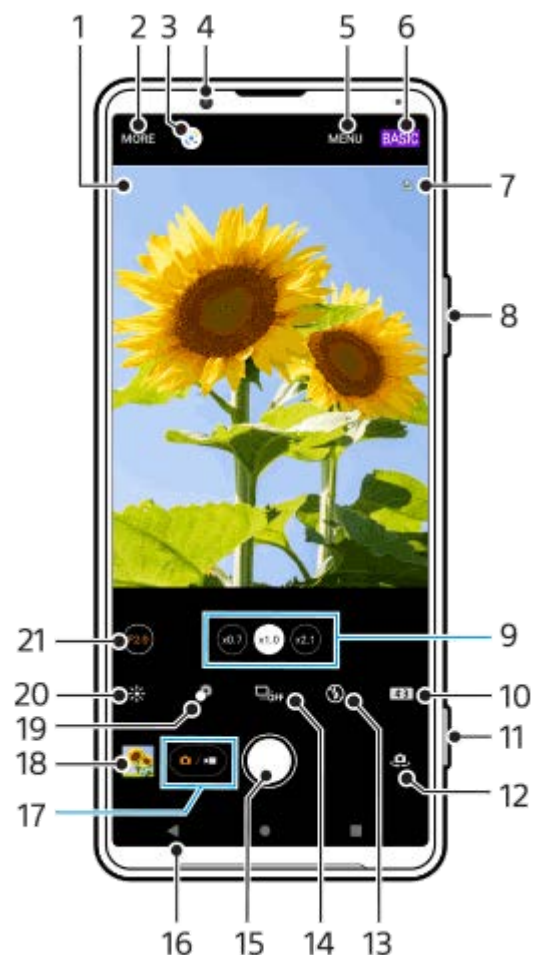

1. Scene recognition icon and conditions icon  
These icons appear when Photo Pro automatically recognizes a scene or condition.
2. Select a capturing mode
3. Google Lens
4. Front camera lens
5. Photo Pro settings menu
6. Switch the shooting mode
7. Geotagging status
8. Use the volume key to zoom in or out
9. Tap one of the angle buttons to switch lenses  
ⓧ (Telephoto button) will be made available through a software update. Software rollouts are a phased process; the timing and availability vary by market and/or operator.
10. Select an aspect ratio
11. Use the camera key to launch Photo Pro or take photos
12. Switch between the front and main camera
13. Select a flash setting. The icon color changes when the flash or flashlight activates.
14. Drive mode button  
Select a self-timer setting or a single shooting or continuous shooting mode.
15. Use the shutter button to take photos
16. Go back or exit Photo Pro

17. Switch between taking photos and videos
18. Tap the thumbnail to view, share, or edit photos
19. Tap to adjust the Bokeh effect
20. Tap to adjust color and brightness
21. Tap to change the aperture value when  $\text{\textcircled{x1.0}}$  (Wide-angle button) is selected.

## ▶ Video mode



1. Selected microphone
2. Select a capturing mode
3. Google Lens
4. Front camera lens
5. Photo Pro settings menu
6. Switch the shooting mode
7. Geotagging status
8. Use the volume key to zoom in or out
9. Tap one of the angle buttons to switch lenses  
 $\text{\textcircled{x2.1}}$  (Telephoto button) will be made available through a software update. Software rollouts are a phased process; the timing and availability vary by market and/or operator.
10. Tap to activate the flashlight. The icon color changes when the flashlight is activated.
11. Use the camera key to launch Photo Pro or record videos
12. Switch between the front and main camera
13. Tap to enable the [Face/Eye AF] function  
 $\text{\textcircled{AF ON}}$  (Face/Eye AF button) will be made available through a software update. Software rollouts are a phased process; the timing and availability vary by market and/or operator.
14. Use the shutter button to record videos
15. Go back or exit Photo Pro
16. Switch between taking photos and videos
17. Tap the thumbnail to view, share, or edit videos
18. Tap to enable HDR (High Dynamic Range)
19. Tap to adjust color and brightness

20. Tap to change the aperture value when  (Wide-angle button) is selected.

---

### Related Topic

- [Selecting a capturing mode](#)
- [Taking a photo or recording a video](#)
- [Geotagging](#)
- [Frequently used features in the BASIC \(Basic\) mode](#)
- [Using the flash](#)
- [Continuous shooting](#)
- [Self-timer](#)
- [Viewing photos and videos](#)
- [Bokeh effect](#)
- [Color and brightness](#)
- [HDR video recording](#)
- [Scanning QR codes](#)
- [Face/Eye AF \(still image/video\)](#)

Smartphone  
Xperia PRO-I XQ-BE52/XQ-BE62/XQ-BE72

## AUTO/P/S/M mode overview

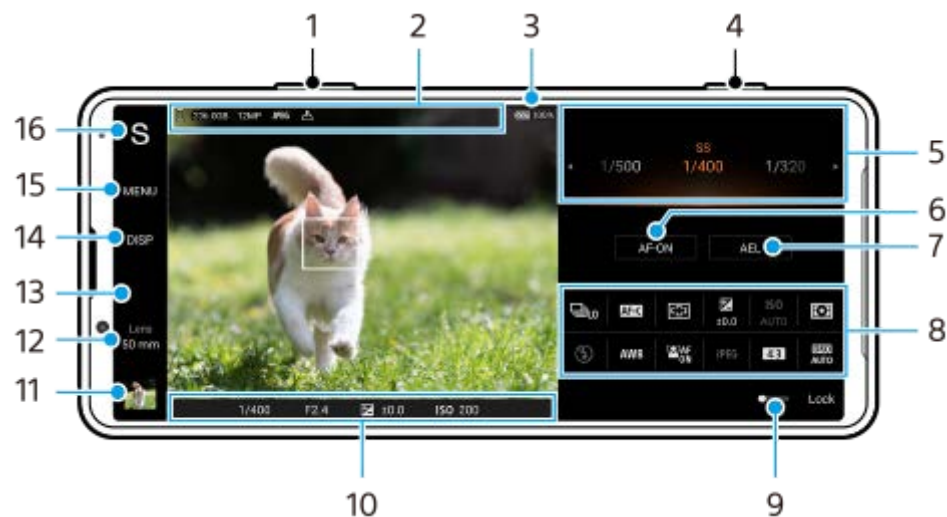

1. Use the volume key to zoom in or out.
2. Data storage icon/Amount of free space/Image size/File format/Geotagging status  
The scene icon or condition icon is also displayed when the AUTO mode is selected.
3. Battery status
4. Use the camera key to launch Photo Pro or shoot images.
5. Dial
  - Adjust the exposure value when the Program auto (P) mode is selected.
  - Adjust the shutter speed when the Shutter speed priority (S) mode or Manual exposure (M) mode is selected.
6. Tap to lock the focus.  
The button turns orange when the focus is locked. Tap the button again to unlock the focus.
7. Tap to lock the exposure.  
The button turns orange when the exposure is locked. Tap the button again to unlock the exposure.  
To assign another function to the AEL button, tap [MENU] > [Setup] > [AEL button customization].
8. Function menu  
Tap to adjust settings.  
To re-assign or re-order the setting items in the function menu, tap [MENU] > [Setup] > [Function menu customization].
9. Drag the switch to the right to lock the items on the left side of the viewfinder and the function menu, preventing accidental operations.
10. Focus indicator/exposure settings
  - (Auto focus icon) indicates that the subject is in focus.
  - ✳ (AE lock icon) indicates that the exposure is locked.
11. Tap the thumbnail to view, share, or edit photos.  
Tap ◀ (Back button) to return to the Photo Pro standby screen.

12. Tap to switch lenses.

To use the zoom, tap  (Open zoom dial icon), pinch in or out on the viewfinder, or use the volume key. [50 mm] will be made available through a software update. Software rollouts are a phased process; the timing and availability vary by market and/or operator.

13. Tap to change the aperture value when [Lens] is set to [24 mm].

14. Tap to show or hide information displayed on the viewfinder.

The histogram represents the luminance distribution graphically.

The level meter helps you to measure the angle of the device and keep the picture horizontal. When your device senses that it is level, the level meter turns green.

To customize the items that are displayed when you tap [DISP], tap [MENU] > [Setup] > [DISP button customization].

15. Tap to adjust more detailed settings.

16. Tap to switch the shooting mode.

To select the default shooting mode when Photo Pro is launched, tap [MENU] > [Setup] > [Shooting mode at launch], and then select an option.

---

### Related Topic

- [Function menu](#)
- [Shooting still images](#)
- [Auto mode \(AUTO\)](#)
- [Program auto \(P\)](#)
- [Shutter speed priority \(S\)](#)
- [Manual exposure \(M\)](#)
- [Camera settings memory](#)
- [Memory recall \(MR\)](#)
- [Pairing with a Bluetooth remote commander](#)

## Launching Video Pro

Video Pro is a video recording function that excels in mobility and flexibility of shooting. Video Pro allows you to shoot video with flexibility and accuracy according to your shooting environment. You are now free to capture your creative vision.



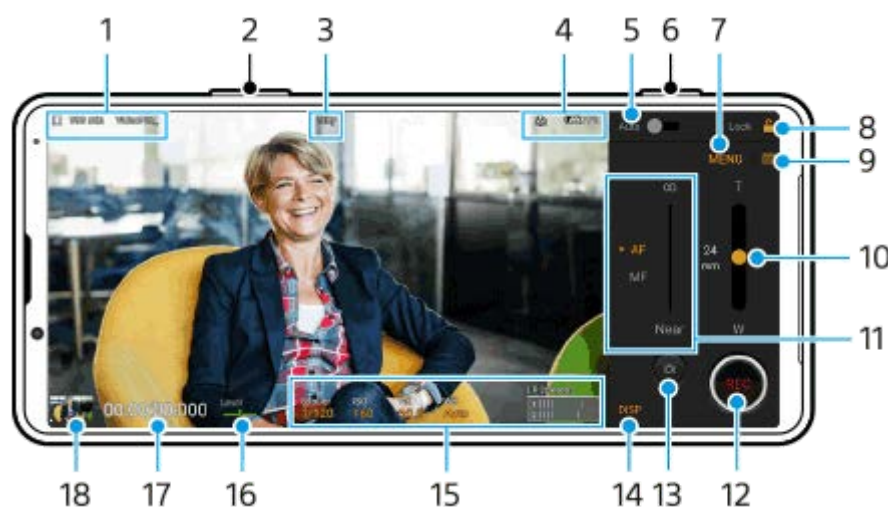

- 1 Find and tap  (Video Pro icon).

### Video Pro home screen



#### Hint

- Tap orange parameters to change settings.

1. Data storage icon/Remaining recordable time/Title prefix  
The file name of the recorded video is "Title prefix\_Date\_Time".  
To change the title prefix, tap  (Settings icon) > [Title prefix].
2. Use the volume key to zoom in or out.
3. Recording status
4. Status indications  
 (Slow-motion recording icon)/ (Heat caution icon)/ (Geotagging status icon)/ **100%** (Battery status icons)
5. Tap to adjust the appropriate shutter speed, ISO value, and white balance automatically.
6. Use the camera key to start or stop recording.
7. Menu button – Tap to open the menu.  
To switch pages, tap [1] or [2].
8. Tap to lock the items and prevent accidental operations.
9. Settings icon – Tap to open Settings.
10. Drag the slider to zoom in or out.

11. Drag the slider to adjust the focus manually.  
To switch the focus mode to auto or manual, tap [AF] or [MF]
12. Tap to start or stop recording.
13. Tap to capture the current frame as a still image.
14. Tap to show or hide information displayed on the viewfinder.
15. Tap to adjust settings.
16. Level meter  
The level meter helps you to measure the angle of the device and keep the picture horizontal. When your device senses that it is level, the level meter turns green.
17. Time code (hours: minutes: seconds: frames)
18. Tap the thumbnail to view, share, or edit videos.  
To return to Video Pro, swipe down on the screen or tap ◀ (Back button).

---

---

### Related Topic

- [Video Pro Menu](#)
- [Video Pro Settings](#)
- [Pairing with a Bluetooth remote commander](#)



Smartphone  
Xperia PRO-I XQ-BE52/XQ-BE62/XQ-BE72

## Video Pro Menu

Tap [Menu] to open the menu. To switch pages, tap [1] or [2]. Menus on page 2 can also be adjusted by tapping icons at the bottom of the viewfinder.

### Hint

- Tap orange parameters to change settings.

- **Lens**

Selects a lens.

[50 mm] will be made available through a software update. Software rollouts are a phased process; the timing and availability vary by market and/or operator.

- **Iris**

Changes the aperture when [Lens] is set to [24 mm].

- **HDR**

Enables or disables HDR (High Dynamic Range).

- **FPS**

Adjusts the frame rate.

- **Video format**

Selects a video format.

- **Slow motion**

Enables or disables slow-motion recording.

- **Markers**

Set [Use markers] to [On] to display markers and guidelines. You can set the types of markers and guidelines to be displayed.

- **Video light**

Turns the flashlight on or off.

- **Stabilization**

Turns video stabilization on or off.

- **WB**

Adjusts the white balance. To adjust the white balance according to a selected white area, select [Custom 1], [Custom 2], or [Custom 3], tap [Set], hold your device so that the white area fully covers the frame in the center, and then tap [Set] again.

- **Gain/ISO**

Adjusts the ISO sensitivity or gain. To switch the displayed value between the ISO sensitivity and gain, tap  (Settings icon) > [ISO/Gain mode].

- **Shutter**

Set to [Auto] to adjust the shutter speed automatically according to the subject. When the shutter speed is turned off by tapping the switch, the shutter speed is adjusted according to the selected frame rate.

- **AE level**

Changes the automatic exposure adjustment value.

- **Input volume/Output volume**

Changes the audio level.

- **Face/Eye AF**

Detects and focuses on the faces or eyes of people and animals.

The [Face/Eye AF] function is not available when [FPS] is set to [119.88] or [Video format] is set to [3840x2160P] and [FPS] is set to [59.94].

The [Face/Eye AF] function will be made available through a software update. Software rollouts are a phased process; the timing and availability vary by market and/or operator.

---

### Related Topic

- [Launching Video Pro](#)
- [Video Pro Settings](#)

F-703-100-11 Copyright 2021 Sony Corporation

Smartphone  
Xperia PRO-I XQ-BE52/XQ-BE62/XQ-BE72

## Video Pro Settings

---

Tap  (Menu icon) to open the Settings menu.

### Shooting

- **ISO/Gain mode**  
Switches the displayed value between the ISO sensitivity and gain.
- **AGC Limit (HDR)/AGC Limit (SDR)**  
Sets the upper limit for AGC (Auto Gain Control). An upper limit is not set when [Off] is selected. [AGC Limit (HDR)] and [AGC Limit (SDR)] are available when [ISO/Gain mode] is selected in [Gain].
- **Auto ISO Limit (HDR)/Auto ISO Limit (SDR)**  
Sets the upper limit for the ISO sensitivity. An upper limit is not set when [Off] is selected. [Auto ISO Limit (HDR)] and [Auto ISO Limit (SDR)] are available when [ISO/Gain mode] is selected in [ISO].
- **Object tracking**  
Detects and tracks a moving objects.  
The [Object tracking] function is not available when [FPS] is set to [119.88] or [Video format] is set to [3840x2160P] and [FPS] is set to [59.94].  
The [Object tracking] function will be made available through a software update. Software rollouts are a phased process; the timing and availability vary by market and/or operator.

### Project

- **File format (4K)**  
Sets the file format for recording.

### Media

- **Title prefix**  
Changes the title prefix. The file name of the recorded video is "Title prefix\_Date\_Time".
- **Data storage**  
Selects the internal storage or an SD card as the save destination.

### Audio

- **Intelligent wind filter**  
Reduces wind noise.
- **Mic**  
Selects [LR (stereo)] or [Rear (mono)]. When [Rear (mono)] is selected, touch the rear panel as little as possible during recording to avoid noise being recorded.

### Technical

- **Assign camera key**  
**REC:** Uses the camera key as a REC button. You can start recording by pressing the camera key even if a setting dialog is open.  
**Photo:** Uses the camera key as a shutter button. You can take a photo during recording by pressing the camera key even if a setting dialog is open.  
**Off:** No functions are assigned.
- **Assign volume keys**

**Zoom:** Uses the volume key to zoom in or out. You can zoom in or out by pressing the volume key even if a setting dialog is open.

**REC:** Uses the volume key as a REC button. You can start recording by pressing the volume key even if a setting dialog is open.

**Volume:** Activates the volume key for Video Pro.

**Off:** No functions are assigned.

- **Lock options**

**Whole screen:** Locks the whole screen including the REC button and  (Camera icon) when you lock the screen.

**Not REC/Photo:** Does not lock the REC button and  (Camera icon) when you lock the screen.

- **Save location**

Saves your still images and videos with the location where they were shot.

## Maintenance

- **Level calibration**

Calibrates the standard for the horizontal plane to fix deviations in the direction of tilt.

- **Bluetooth remote control**

Pairs with a Bluetooth remote commander.

- **Reset settings**

Resets all settings to their defaults.

---

## Related Topic

- [Launching Video Pro](#)
- [Video Pro Menu](#)
- [Pairing with a Bluetooth remote commander](#)

Smartphone  
Xperia PRO-I XQ-BE52/XQ-BE62/XQ-BE72

## Launching the Cinema Pro app

Cinema Pro is an application powered by Sony’s digital motion picture camera technology. You can create your ideal videos by configuring various parameters and color settings.

- 1 Find and tap  (Cinema Pro icon).

### Cinema Pro home screen

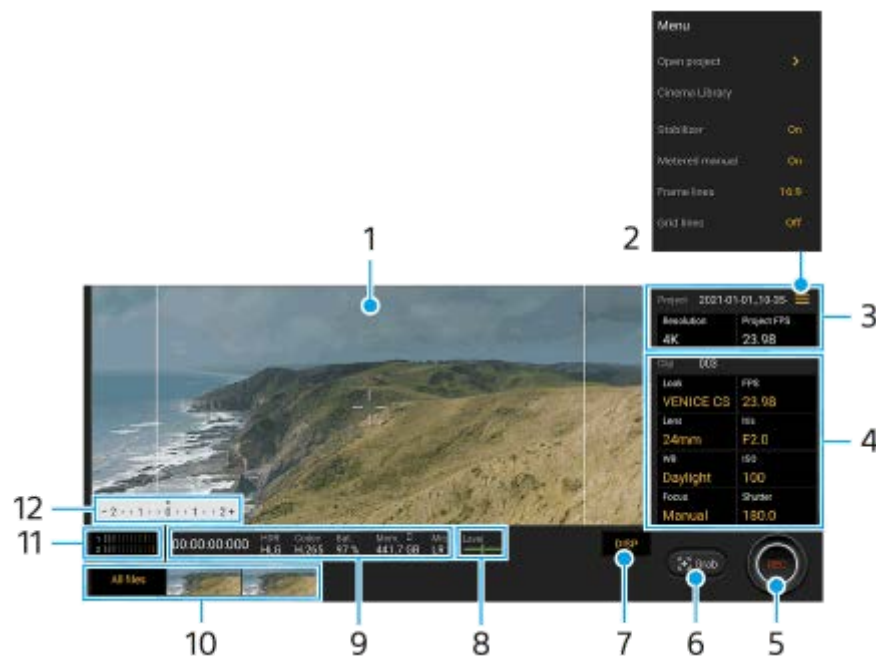

#### Hint

- Tap orange parameters to change settings.
- For more information about the Cinema Pro app, tap  (Menu icon) > [Tips].

#### 1. Viewfinder

#### 2. Menu icon – Tap to open the menu.

- Tap [Open project] to open an existing project or to create a new project. When creating a new project, select the internal storage or an SD card as the save destination.
- Tap [Cinema Library] to launch the Cinema Library app. You can open an existing project or watch a created film.
- Tap [Stabilizer] to switch the stabilizer function on or off.
- Tap [Metered manual] to show or hide the Metered Manual. The Metered Manual is displayed with a metering indicator on the viewfinder.
- Tap [Frame lines] repeatedly to display and select from various aspect ratios.
- Tap [Grid lines] to display and balance the composition.
- Tap [Level] to turn the level meter on or off.
- Tap [Level calibration] to calibrate the standard for the horizontal plane to fix deviations in the direction of tilt.
- Tap [Remaining memory format] to switch the unit for displaying the remaining memory between the remaining recordable time and the remaining memory capacity.
- Tap [Audio settings] to select a microphone, reduce wind noise, or change the audio level.

- Tap [Assign camera key] to use the camera key as a REC button or a Grab button. When [Record] is selected, you can start recording by pressing the camera key even if a setting dialog is open.
- Tap [Assign volume keys] to use the volume key as a REC button, to activate the volume key, or to control the manual focus in the Cinema Pro app. When [Record] is selected, you can start recording by pressing the volume key even if a setting dialog is open.
- Tap [Rec button pos.] to change the position of the REC button and the Grab button.

### 3. Project settings

Tap an orange parameter to adjust the resolution and frame rate of the entire project or video clips. The project settings can only be changed before recording the first video clip.

### 4. Clip settings – Parameters to adjust for each video clip.

- Tap [Look] to adjust the ambience of the video clip.
- Tap [FPS] to adjust the frame rate. Select [120] to record a video in slow motion.
- Tap [Lens] to select a lens.  
[50 mm] will be made available through a software update. Software rollouts are a phased process; the timing and availability vary by market and/or operator.
- Tap [Iris] to change the aperture value when [Lens] is set to [24 mm].
- Tap [ISO] to adjust the ISO value. Tap [Auto] when it is orange to adjust to the appropriate ISO value automatically.
- Tap [WB] to adjust the white balance. You can use the sliders to adjust the white balance. Tap [Reset] to reset the slider values for the selected setting.  
To adjust the white balance according to a selected white area, select [Custom], tap [Set], hold your device so that the white area fully covers the frame in the center, and then tap [Set] again.  
If you select [Auto], you can set whether to lock the white balance settings.
- Tap [Shutter] to adjust the shutter speed. Tap [Auto] when it is orange to adjust the appropriate shutter speed automatically.
- Tap [Focus] to adjust the focus. Tap [AF] or [MF] to switch the focus mode to auto or manual. When the focus mode is set to manual, you can adjust the focus markers and speed of focus pulling by tapping  (Settings icon). When the focus mode is set to auto, you can specify the focus area by tapping the viewfinder.

### 5. Tap to start or stop recording.

### 6. Tap to capture the current frame as a still image.



### 7. Tap to hide or show the frame lines, grid lines, and the Metered Manual.

### 8. Level meter

Level meter helps you to measure the angle of the device and keep the picture horizontal. When your device senses that it is level, the level meter turns green.

### 9. Status indications

### 10. Thumbnail

- Tap a thumbnail to view a video clip or still image. Swipe left or right to view the previous or next video clip or still image.  
To return to the Cinema Pro home screen, swipe down on the screen or tap  (Back button).
- Tap [All files] to view a video clip or still image that is not in the thumbnail view. While viewing a video clip or still image, swipe left or right to view the previous or next one.  
To return to the previous screen, swipe down on the screen or tap  (Back button).
- You can capture a still image from the video by tapping  (Edit video icon) while playing.

#### Hint

- 120 fps videos are played back at 120 Hz even when [High refresh rate] in the Settings menu is set to off.

### 11. Audio level meter

Tap the meter to open the audio settings menu.

- Tap [Mic] to select [LR] or [Rear]. When [Rear] is selected, touch the rear panel as little as possible during recording to avoid noise being recorded.
- Tap [Intelligent wind filter] to reduce wind noise.
- Select a value to change the audio level.

## 12. Metered manual

The Metered Manual indicates underexposure/overexposure.

---

### Related Topic

- [Combining clips and watching a film](#)
- [Screen settings](#)

F-703-100-11 Copyright 2021 Sony Corporation

Smartphone  
Xperia PRO-I XQ-BE52/XQ-BE62/XQ-BE72

## Combining clips and watching a film



You can combine clips to create a film, and then watch the film using the Cinema Library.

- 1 While using the Cinema Pro app, tap [All files] to display a list of clips in a project.
- 2 Tap  (More icon) > [Create final film].
- 3 Tap the clips in the order in which you want to combine them.
- 4 Tap [Create].



### Note

- Clips with different frame rates cannot be combined.

## To watch the created film using the Cinema Library

1. Launch the Cinema Library app.
  - While using the Cinema Pro app, tap [All files] >  (Cinema Library icon).
  - While using the Cinema Pro app, tap  (Menu icon) > [Cinema Library].
  - Touch and hold  (Cinema Pro icon), and then tap [Cinema Library] in the menu that opens.
2. Tap [Final films], and then select a film.

### Hint

- You can create a shortcut for the Cinema Library app on the Home screen. Touch and hold  (Cinema Pro icon). From the menu that opens, drag  (Cinema Library icon) to the desired location.
- 120 fps videos are played back at 120 Hz even when [High refresh rate] in the Settings menu is set to off.

## Related Topic

- [Launching the Cinema Pro app](#)
- [Screen settings](#)



Smartphone

Xperia PRO-I XQ-BE52/XQ-BE62/XQ-BE72

## Pairing with a Bluetooth remote commander

You can operate Photo Pro and Video Pro on your Xperia device with a Bluetooth remote commander manufactured by Sony (sold separately).

For details on compatible remote commanders, visit the Sony website for your area or consult your Sony dealer or local authorized Sony service facility.

Refer to the instruction manual for the Bluetooth remote commander as well.

- 1 On your Xperia device, launch Photo Pro or Video Pro.
- 2 On your Xperia device, tap [MENU] (for Photo Pro) or ≡ (Settings icon) (for Video Pro).
- 3 On your Xperia device, tap [Bluetooth remote control], and then tap the switch to enable the function.
- 4 On your Xperia device, tap [Pair new controller].
- 5 On the Bluetooth remote commander, perform pairing.
  - GP-VPT2BT: Press and hold the PHOTO button and the T side of the Zoom button at the same time for at least 7 seconds.
  - RMT-P1BT: Press and hold the Shutter-release/REC button and the Focus/Zoom button (either the + button or the - button) at the same time for at least 7 seconds.

For details, refer to the instruction manual for the Bluetooth remote commander.
- 6 On your Xperia device, follow the on-screen instructions.



Select [Pair & connect] and [PAIR] on the notifications and dialogs that appear multiple times when your Xperia device detects the Bluetooth remote commander. The name of the Bluetooth remote commander may be displayed as a Bluetooth address (numerals and letters).

### Note

- When you perform a factory data reset, pairing information is also erased. To use the Bluetooth remote commander, perform pairing again.
- If the Bluetooth connection is unstable, remove any obstacles such as people or metal objects from between your Xperia device and the paired Bluetooth remote commander.
- If the function does not work properly, check the following notes and then try pairing again.
  - Confirm that the Bluetooth remote commander is not connected with other devices.
  - Confirm that you are not operating your Xperia device using other Bluetooth remote commander.
  - Check if the Airplane mode of your Xperia device is set to off.
  - Check if the Bluetooth function of your Xperia device is set to on.
  - Unpair the Bluetooth remote commander.

### Hint

- Once you pair with the Bluetooth remote commander, you can operate both Photo Pro and Video Pro.
- Turn the [Bluetooth remote control] function on or off individually for Photo Pro and Video Pro.

- To change the name of the paired Bluetooth remote commander, find and tap [Settings] > [Device connection], tap  (Settings icon) beside the name of the paired Bluetooth remote commander, and then tap  (Edit icon).

## To use Camera endurance mode

Your device may limit certain functions as a precaution when under intensive use. By turning on Camera endurance mode, you can maintain high performance for a longer period of time.





1. Tap [MENU] (for Photo Pro) or  (Settings icon) (for Video Pro).
2. Tap [Bluetooth remote control] > [Camera endurance mode], and then tap the switch to enable the function.

### Note

- Camera endurance mode will be made available through a software update. Software rollouts are a phased process; the timing and availability vary by market and/or operator.

## Bluetooth remote commander connection status icons

You can check the connection status of the Bluetooth remote commander on the viewfinder when [Bluetooth remote control] is set to on while using Photo Pro or Video Pro.

-  (Bluetooth remote commander connection icon): Bluetooth remote commander operations are enabled.
-  (Bluetooth remote commander disconnection icon): Bluetooth remote commander operations are disabled.
-  (Camera endurance mode available icon): Camera endurance mode is turned on and available.
-  (Camera endurance mode unavailable icon): Camera endurance mode is turned on but unavailable because you are not using the Bluetooth remote commander to operate Photo Pro and Video Pro.

### Hint

- The Bluetooth connection is only active while you are operating your Xperia device using the Bluetooth remote commander.

## To unpair the Bluetooth remote commander

1. Find and tap [Settings] > [Device connection].
2. Under [Previously connected devices], tap  (Settings icon) beside the name of the Bluetooth remote commander that you want to unpair.
3. Tap [Forget] > [Forget device].

## To operate the Bluetooth remote commander

You can shoot images and record videos by pressing buttons on the Bluetooth remote commander. For more information about operating the Bluetooth remote commander, refer to the Help Guide for the Bluetooth remote commander.

### Hint

- To switch the lenses of the main camera, press the C1 button on the Bluetooth remote commander.

---

## Related Topic

- [Turning the Bluetooth function on or off](#)
- [BASIC \(Basic\) mode overview](#)
- [AUTO/P/S/M mode overview](#)
- [Launching Video Pro](#)
- [Settings menu](#)



Smartphone  
Xperia PRO-I XQ-BE52/XQ-BE62/XQ-BE72

## Using the External monitor app

By connecting to an external camera such as Sony Alpha cameras, External monitor app can help you in the following situations:

- Take advantage of the high-definition display of your Xperia by using it as a camera monitor.
- Ensure your subject is in focus by pinching in or out on the smartphone screen to zoom in or out.
- Find the best lighting in various shooting environments using the Brightness adjustment function.









### 1 Find and tap (External monitor icon) to launch the External monitor app.

If  (External monitor icon) is not in the app drawer, find and tap [Settings] > [Device connection] > [Connection preferences], and then tap the [External monitor] switch.

### 2 Connect a video device.

- Connect a video device that supports USB Video Class (UVC) output to your Xperia via a USB Type-C cable.
- Connect a video device that supports HDMI output to your Xperia using an HDMI cable together with an HDMI-UVC conversion adapter.

## External monitor overview

-  (Screen lock icon): Tap to lock the screen and prevent accidental operations.
-  (Brightness adjustment icon): Tap to adjust the brightness level with the slider.
-  (Grid line icon): Tap to display and select a type of grid line.
-  (Frame line icon): Tap to display and select from among various aspect ratios.
-  (Rotate icon): Tap to rotate the screen 180 degrees.
-  (Settings icon): Tap to adjust more detailed settings.

## Related Topic

- [Settings menu](#)
- [Overview](#)



Smartphone  
Xperia PRO-I XQ-BE52/XQ-BE62/XQ-BE72

## Launching the Game enhancer app

The **Game enhancer** app makes gameplay much more convenient with various functions. While playing a game, you can improve the microphone sound quality when voice-chatting using a headset according to your mic type; adjust the colors, display effects of displayed content, and sounds; and more.

Downloaded games are automatically stored in the **Game enhancer** app, and you can quickly launch the games from My games.

- 1 Find and tap  (Game enhancer icon).

### Screen overview

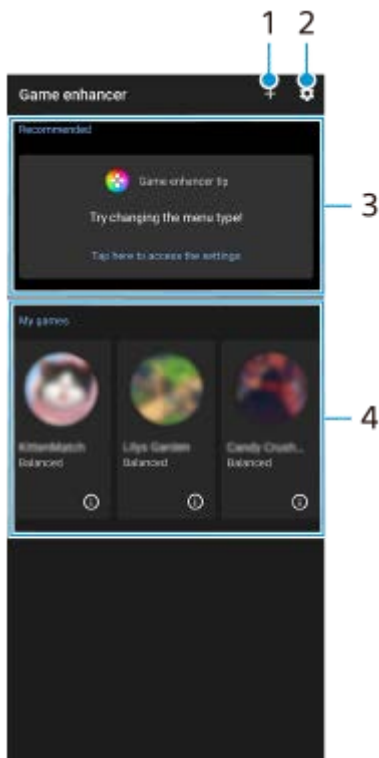

1. Add new games manually.
2. Game enhancer settings
3. Recommended – An introduction to Game enhancer features and recommended games is displayed.
4. My games

Downloaded games will be automatically listed. Tap a game icon to start the game.

To view a screenshot or video taken by the Game enhancer app, tap  (Game profile icon).

### To store game icons

You can store and manage all game apps together in My games. Game icons that you store on the Game enhancer app screen will be hidden from the Home screen and the app drawer.

1. Tap  (Game enhancer settings icon), and then tap the [Store game icons] switch to enable the function.

#### Hint

- If game icons cannot be stored, make sure that you have not changed the Home screen from [Xperia Home] and that  (Game enhancer icon) is located on the Home screen.

---

---

### Related Topic

- [Using the Game enhancer menu](#)
- [Setting \[Display & Sound\] in the Game enhancer menu](#)
- [Using the camera key as a shortcut key for a Game enhancer actions](#)

F-703-100-11 Copyright 2021 Sony Corporation

Smartphone  
Xperia PRO-I XQ-BE52/XQ-BE62/XQ-BE72

## Using the Game enhancer menu

You can customize various settings while playing a game. In the menu with ⓘ (Show details button) in the upper right of the screen, tap ⓘ (Show details button) to view descriptions of settings.

- 1 While playing a game, tap 🎮 (Floating icon).



- 2 In the menu that opens, tap and configure the desired settings.

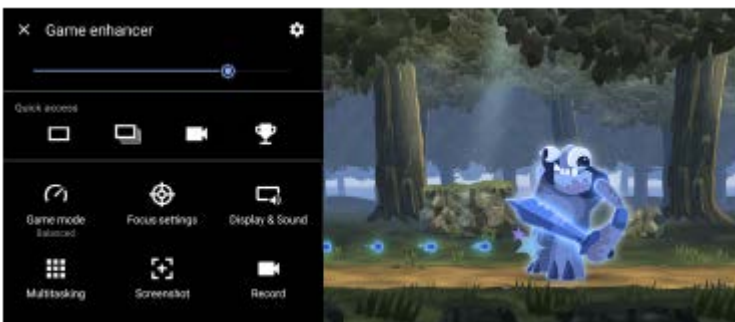

- [Game mode]: Select an option to optimize your device for gaming from among [Performance preferred], [Balanced], [Battery life preferred], and [Custom].  
If you select [Custom], tap ⚙️ (Settings icon) to customize the settings. Tap [Preview] to customize settings while testing out the actual game controls. You can also drag and move the setting window to the desired position.  
You can also set the following items.
  - [Optimize touch area]: Restrict the touch area in the landscape mode.
  - [H.S. power control]: Limit reductions in performance and degradation of the battery caused by the device overheating during charging. While the Game enhancer app is running, the battery will not charge if [H.S. power control] is set to on.
- [Focus settings]: Focus on your game by blocking notifications, incoming calls, the camera key, and other settings that may compromise gameplay.
- [Display & Sound]: Adjust the colors, display effects of displayed content, and sounds while playing a game.
- [Multitasking]: View a website or use other apps. You can search for strategy information while playing a game.
- [Screenshot]: Take a screenshot. You can also take a burst of screenshots and capture a decisive moment in a game.
- [Record]: Record and share your gameplay, face, and commentary.

### Hint

- The STAMINA mode is turned off while you use the Game enhancer app. If you want to give priority to the battery life, set [Game mode] to [Battery life preferred].





## To switch the menu type



The menu type can be switched between  (Pull-down bar) and  (Floating icon) individually for each game.

1. Tap  (Floating icon) >  (Game enhancer settings icon) > [Menu type], and then select an option.

### Hint

- You can drag and move  (Floating icon) to the desired position, such as the edge of the screen.
- To change the menu type setting for all previously added games, on the Game enhancer main screen, tap  (Game enhancer settings icon) > [Default menu type], and then select an option and tap [APPLY].



## To view a web site or use other apps while playing a game

1. While playing a game, tap  (Floating icon) > [Multitasking].
2. Tap [WEB], [YouTube], or [APPS].
  - To go back to the menu, tap  (Back button).
  - To minimize the [Multitasking] window, tap  (Minimize button).
  - When you select an app in [APPS], the app opens in the pop-up window.

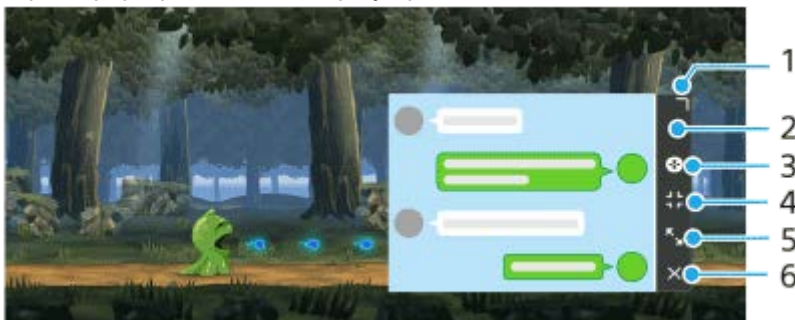

Tap the pop-up window to display operation icons.



1. Drag to resize the window.
2. Drag to move the window.
3. Display the Game enhancer menu.
4. Tap to minimize the window. To reopen the pop-up window, tap  (Floating icon) or  (Pull-down bar).
5. Tap to maximize the window.
6. Tap to close the window.

### Related Topic

- [Launching the Game enhancer app](#)
- [Setting \[Display & Sound\] in the Game enhancer menu](#)
- [STAMINA mode](#)



Smartphone  
Xperia PRO-I XQ-BE52/XQ-BE62/XQ-BE72

## Setting [Display & Sound] in the Game enhancer menu

You can adjust the colors, display effects of displayed content, and sounds while playing a game. Tap ⓘ (Show details button) to view descriptions of settings.

### Adjusting the colors of displayed content

You can preset up to 4 settings for [Image quality settings]. By selecting a preset according to your gaming situation, you can apply the appropriate settings.

1. While playing a game, tap 🎮 (Floating icon) > [Display & Sound].
2. Tap [Image quality settings].
3. Tap ⏪ (Back icon) or ⏩ (Forward icon) in the top center of the menu screen to select the preset you want to set, and then set the options.
  - [Picture mode] and [L-γ raiser]: Tap to select an option.
  - [White balance]: Drag the slider to set the value.
  - To change the name of a preset, tap ✎ (Edit icon) (maximum of 4 characters).

### Adjusting the sound using Audio equalizer

You can preset up to 4 settings for [Audio equalizer]. By selecting a preset according to your gaming situation, you can apply the appropriate settings.

1. While playing a game, tap 🎮 (Floating icon) > [Display & Sound].
2. Tap the [Audio equalizer] switch to enable the setting.
3. Tap ⏪ (Back icon) or ⏩ (Forward icon) in the top center of the menu screen to select the preset you want to set, and then adjust the value for each frequency.
  - To change the name of a preset, tap ✎ (Edit icon) (maximum of 4 characters).
  - The values can be adjusted only when the [Audio equalizer] switch is set to on.

### Customizing the video settings output to a connected external device

You can customize the video settings output to an external device connected to the USB port on your device using a USB Type-C cable. Note that settings changed in [USB external output] affect the whole device, not only the Game enhancer app.

1. While playing a game, tap 🎮 (Floating icon) > [Display & Sound].
2. Tap [USB external output], and then select an option.
3. Connect or reconnect the external device.

#### Note

- Settings changed in [USB external output] apply after you reconnect the cable. Settings may not be applied if you reconnect the cable immediately after launching the Game enhancer app. Reconnect the cable about 1 minute after the Game enhancer app starts.
- Video signals may not be output according to the setting on your device depending on the displayed app or the specifications of the connected external device.

### Improving the microphone sound quality when voice-chatting

The other party will hear your voice more clearly during voice chat. Adjust the setting according to your mic type. This function only works when a headset is connected to the 3.5 mm audio jack of your device.

1. While playing a game, tap  (Floating icon) > [Display & Sound].
2. Under [Optimize V.C. microphone] select an option.

---

---

### Related Topic

- [Using the Game enhancer menu](#)
- [Overview](#)

F-703-100-11 Copyright 2021 Sony Corporation

Smartphone  
Xperia PRO-I XQ-BE52/XQ-BE62/XQ-BE72

## Using the camera key as a shortcut key for a Game enhancer actions

You can assign a Game enhancer action used in-game to the camera key. You can change the setting individually for each game.

1 Tap  (Floating icon) >  (Game enhancer settings icon) > [Hardware key shortcut] > [Camera key press], and then select an option.

- [Default (device's settings)]: Apply the device's settings.
- [Open/close Game enhancer]: Open or close the Game enhancer menu.
- [Optimize touch area On/Off]: Turn the [Optimize touch area] function on or off.
- [Quick preset switcher]: Quickly switch presets for [Image quality settings] or [Audio equalizer] in [Display & Sound].

### Note

- The [Optimize touch area] function is available when [Menu type] is set to [Pull-down bar] and the device is in the landscape mode. If a message appears when you press the camera key, confirm the setting descriptions for the [Optimize touch area] function.
- The [Disable camera key] function in [Focus settings] is turned off when a Game enhancer action is assigned to the camera key.

### Hint

- To change the [Hardware key shortcut] setting for all previously added games, on the Game enhancer main screen, tap  (Game enhancer settings icon) > [Default hardware key shortcut] > [Camera key press], and then select an option and tap [APPLY].

### Related Topic

- [Launching the Game enhancer app](#)
- [Using the Game enhancer menu](#)
- [Setting \[Display & Sound\] in the Game enhancer menu](#)
- [Overview](#)

Smartphone

Xperia PRO-I XQ-BE52/XQ-BE62/XQ-BE72

## Enhancing the sound output using 360 Spatial Sound

---

Using 360 Spatial Sound makes playback of all stereo sound sources, including streaming services, sound like spatial audio. It is recommended that you use headphones to enjoy the effects produced by the function.

- 1 Find and tap **[Settings] > [Sound] > [Audio settings]**.
- 2 Tap the **[360 Spatial Sound]** switch to enable the function.
- 3 Tap **[360 Spatial Sound]** for more options.

### Note

- The function is effective only when you are using an app compatible with 360 Spatial Sound.
- If both 360 Spatial Sound and Dolby Atmos are turned on, only one of the functions may be effective depending on the app you are using. When you are using a music-related app, 360 Spatial Sound takes priority.
- The sound quality of the original sound source may take priority over the effects produced by 360 Spatial Sound, depending on the content.

---

### Related Topic

- [Settings menu](#)

Smartphone  
Xperia PRO-I XQ-BE52/XQ-BE62/XQ-BE72

## Enhancing the sound output using Dolby Atmos®

---

Using Dolby Atmos makes playback sound more realistic and three dimensional.

- 1 Find and tap [Settings] > [Sound] > [Audio settings].
- 2 Enable the Dolby Atmos function by tapping the switch.
- 3 Tap [Dolby Atmos] for more options.

### Note

- To enjoy High-Resolution Audio with its original quality, turn off the Dolby Atmos function.
- If DSEE Ultimate or 360 Spatial Sound is turned on while Dolby Atmos is also turned on, only one of the functions may be effective depending on the app you are using. When you are using a music-related app, DSEE Ultimate or 360 Spatial Sound takes priority.

---

### Related Topic

- [Settings menu](#)

Smartphone

Xperia PRO-I XQ-BE52/XQ-BE62/XQ-BE72

## Upscaling the quality of compressed music files (DSEE Ultimate)

---

The DSEE Ultimate function upscales your compressed music accurately using AI technology.

- 1 Find and tap **[Settings]** > **[Sound]** > **[Audio settings]**.
- 2 Enable the DSEE Ultimate function by tapping the switch.

### Note

- If both DSEE Ultimate and Dolby Atmos are turned on, only one of the functions may be effective depending on the app you are using. When you are using a music-related app, DSEE Ultimate takes priority.

---

### Related Topic

- [Settings menu](#)



Smartphone  
Xperia PRO-I XQ-BE52/XQ-BE62/XQ-BE72

## Reducing wind noise when recording

---

You can remove the noise produced by wind hitting the microphone when recording without losing the original audio quality.

- 1 Find and tap **[Settings] > [Sound] > [Audio settings] > [Intelligent wind filter]**.
  - 2 Tap the switch to enable the function.
- 

### Related Topic

- [Settings menu](#)
- [Taking a photo or recording a video](#)

Smartphone  
Xperia PRO-I XQ-BE52/XQ-BE62/XQ-BE72

## Using the pop-up window mode

You can display another app in a small window overlaid on top of an app running in the full-screen mode. You can also display a third app in the pop-up window while viewing two apps using the Split-screen mode.

- 1 Tap  (Overview button) in the navigation bar.

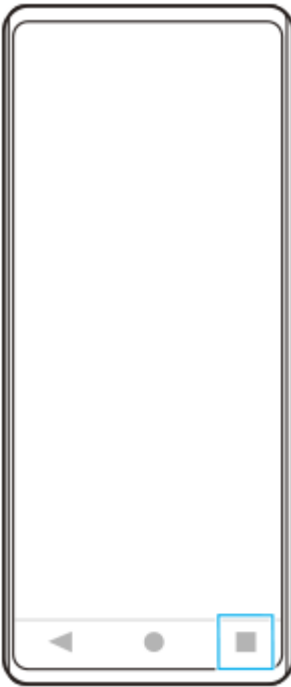

- 2 Swipe left or right to select the app that you want to display in a small window, and then tap [Pop-up window].



- 3 Swipe left or right to select the app that you want to display in the full-screen, and then tap it.

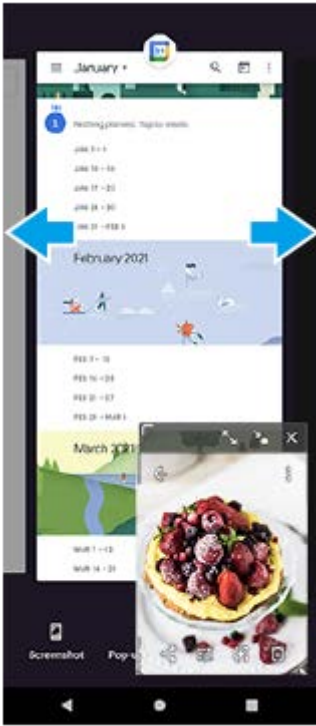

### Pop-up window overview

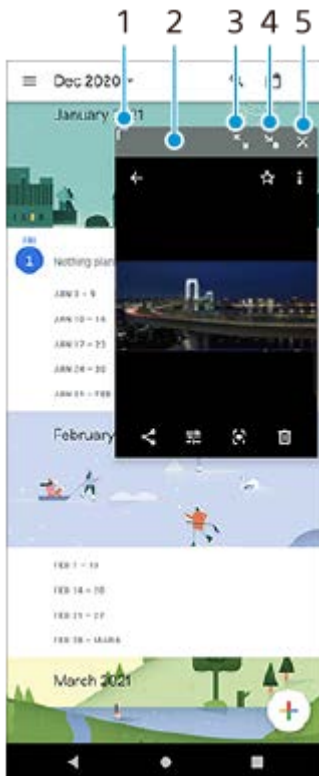

1. Drag to resize the window.
2. Drag to move the window.
3. Tap to maximize the window.
4. Tap to iconize the window.
5. Tap to close the window.

### Note

- Not all apps support the pop-up window mode.
- The pop-up window mode may be unavailable depending on the function or app you are using, such as when using Photo Pro.

Smartphone  
Xperia PRO-I XQ-BE52/XQ-BE62/XQ-BE72

## Using the Split-screen mode

The Split-screen mode enables you to view two applications at once, such as when you want to view your photos and the Calendar at the same time.

- 1 Tap  (Overview button) in the navigation bar.

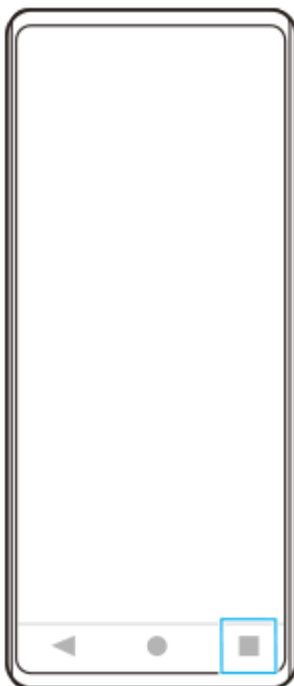

- 2 Tap [Multi-window switch].



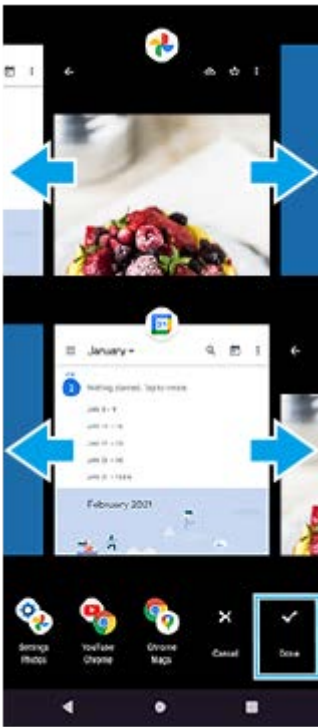

3 Swipe left or right to select the desired apps, and then tap [Done].

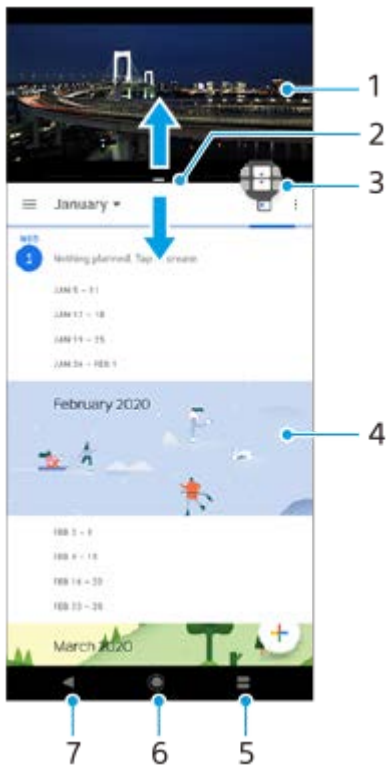

### Split-screen overview



1. Application 1
2. Split-screen border – Drag to resize windows
3. Multi-window switch icon – Tap  (Multi-window switch icon) to select applications.  (Multi-window switch icon) appears when you drag the split-screen border.
4. Application 2
5. Overview button – Select a recently used application for the lower window
6. Home button – Go back to the Home screen
7. Back button – Go back to the previous screen within an application or close the application

**Note**

- Not all applications support split-screen mode.

**To resize the split-screen windows**

1. Drag the split-screen border in the center.

**To exit the split-screen mode**

1. Drag the split-screen border to the top or bottom of the screen.

Smartphone  
Xperia PRO-I XQ-BE52/XQ-BE62/XQ-BE72

## Using Dynamic Vibration

---

The Dynamic Vibration feature enhances your media experience by adding synchronized vibration when you watch videos or listen to music on your device. To learn more about this feature, go to [Settings] > [Sound] > [Dynamic Vibration].

There is no vibration in the following cases:

- The media volume is set to silent.
- The screen is off.

### Note

- Dynamic Vibration does not work with all media apps.

- 1 Find and tap [Settings] > [Sound] > [Dynamic Vibration].
- 2 Tap the switch to enable the function.

---

### Related Topic

- [Settings menu](#)
- [Adjusting Dynamic Vibration settings](#)



Smartphone

Xperia PRO-I XQ-BE52/XQ-BE62/XQ-BE72

## Adjusting Dynamic Vibration settings

---

### Adjusting the vibration level while playing content using a media app

1. Open the desired media app, such as the Music app.
2. Start playback of the media contents.
3. Press the volume key to open the volume panel.
4. Drag the slider for Dynamic Vibration to set the preferred level for this app.  
The Dynamic Vibration setting is saved for the next time you use this app.

### Adjust the timing of vibration to the sound from wireless devices

1. Find and tap [Settings] > [Sound] > [Dynamic Vibration].
2. Adjust the [Synchronization] slider, and then tap [TEST] to confirm the adjusted timing.

---

#### Related Topic

- [Settings menu](#)
- [Using Dynamic Vibration](#)

Smartphone  
Xperia PRO-I XQ-BE52/XQ-BE62/XQ-BE72

## Setting the Ambient display

The Ambient display lets you view information such as the time, notifications, or music on the screen when the screen is turned off. The Ambient display can also show album art while music is playing.



### Adjusting the Ambient display settings

1. Tap [Settings] > [Appearance] > [Ambient display (Always-on display)].
2. Tap [When to show Ambient display], and then select the desired setting.
3. Close the setting menu.  
The setting is saved.

#### Hint

- If you set [When to show Ambient display] to [Smart activation], the Ambient display will be activated when needed, for example, when walking with the device in your hand or taking the device out of your pocket or bag.

### Displaying an image on the Ambient display

1. Tap [Settings] > [Appearance] > [Ambient display (Always-on display)].
2. Tap [Sticker], and then select your desired sticker or photo.
3. Close the setting menu.  
The setting is saved.

#### Related Topic

- [Settings menu](#)



Smartphone

Xperia PRO-I XQ-BE52/XQ-BE62/XQ-BE72

## Using the shortcut key

---

You can quickly launch an assigned app by pressing the shortcut key on the device. Video Pro is assigned by default.

### To change the assigned app

1. Find and tap [Settings] > [System] > [Gestures] > [Shortcut key].
2. Tap the switch to enable the function.
3. Select an app from the list as desired.

#### Hint

- You can change the apps in the list by tapping  (Edit icon).
- If you assign Photo Pro or Video Pro to the shortcut key, you can launch Photo Pro or Video Pro without unlocking your device by pressing the key when your screen is turned off.

---

### Related Topic

- [Overview](#)
- [Settings menu](#)

Smartphone  
Xperia PRO-I XQ-BE52/XQ-BE62/XQ-BE72

## Turning Side sense on or off

---

- 1 Find and tap **[Settings]** > **[Display]** > **[Advanced]**.
  - 2 Tap **[Side sense]**.
  - 3 Tap the switch to enable or disable the function.
- 
- 

### Related Topic

- [Settings menu](#)
- [Using Side sense](#)
- [Setting other Side sense options](#)

Smartphone  
Xperia PRO-I XQ-BE52/XQ-BE62/XQ-BE72

## Using Side sense

---

You can tap the Side sense bar on the edge of the screen or slide it with one hand in order to use your device more easily. You can display the Side sense menu as a shortcut to applications and settings, or the Multi-window menu to select two applications in the split-screen mode. You can also return to the previous screen by sliding down along the Side sense bar on the edge of the screen. Make sure to tap or slide your finger within the Side sense bar.



### Note

- Side sense may not be available depending on the apps and functions that you are using.

## Customizing the Side sense bar

To move the Side sense bar up or down, touch and hold the Side sense bar, and then drag it up or down.  
To place the touch position anywhere you want on the screen, touch and hold the Side sense bar, and then drag it toward the center of the screen. The shape of the Side sense bar changes to a circle, and you can drag and place it anywhere you want on the screen.

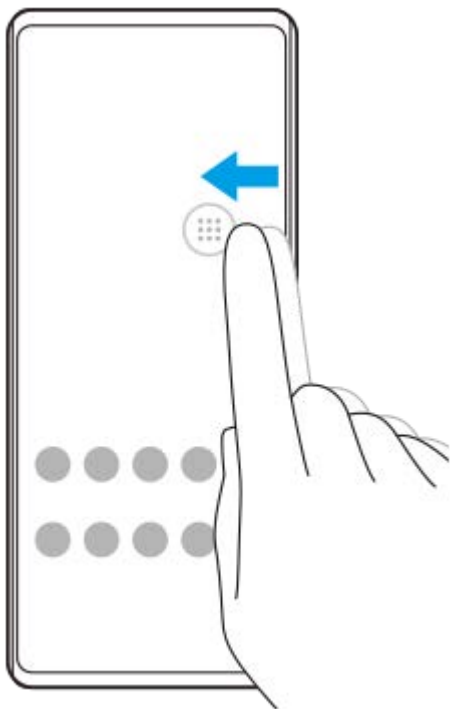

#### Hint

- To return the Side sense bar to its original shape, drag the circle back to the edge of the screen.

### Displaying the Side sense menu

To activate the Side sense menu, double-tap the Side sense bar or circle. Follow the on-screen instructions to select an app. You can also launch an app in a pop-up window.

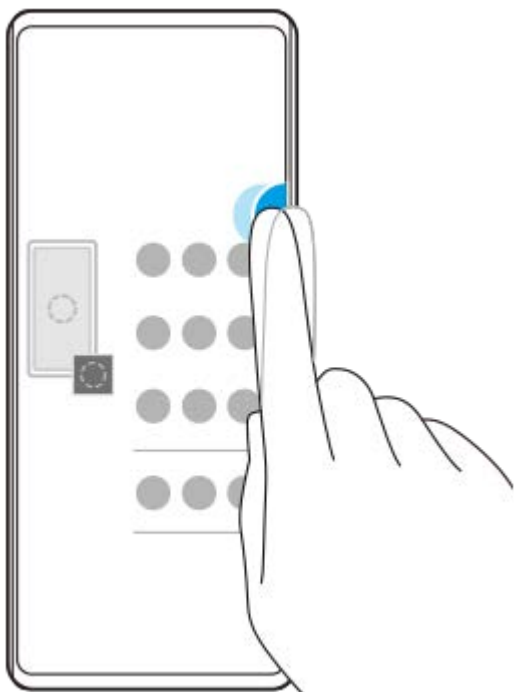

#### Hint

- To exit the Side sense menu, double-tap the Side sense bar or tap an empty area on the screen.

### Displaying the Multi-window menu

Slide up the Side sense bar or circle to display the Multi-window menu. Follow the on-screen instructions to add apps to a split-screen.

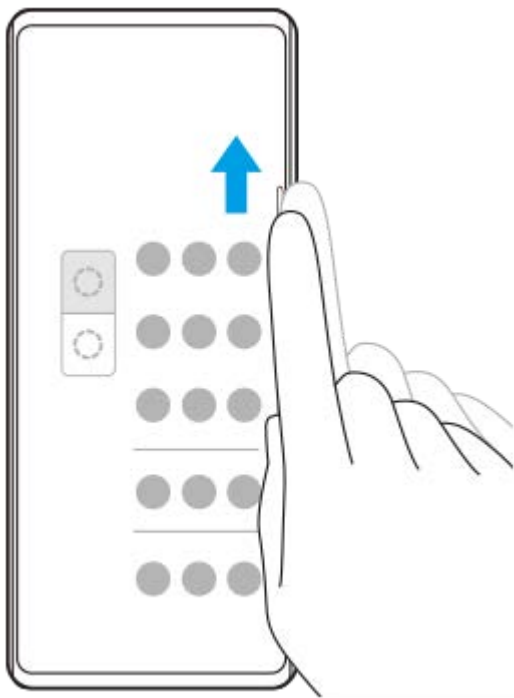

### Returning to the previous screen using the Side sense bar

Slide down the Side sense bar or circle to return to the previous screen.

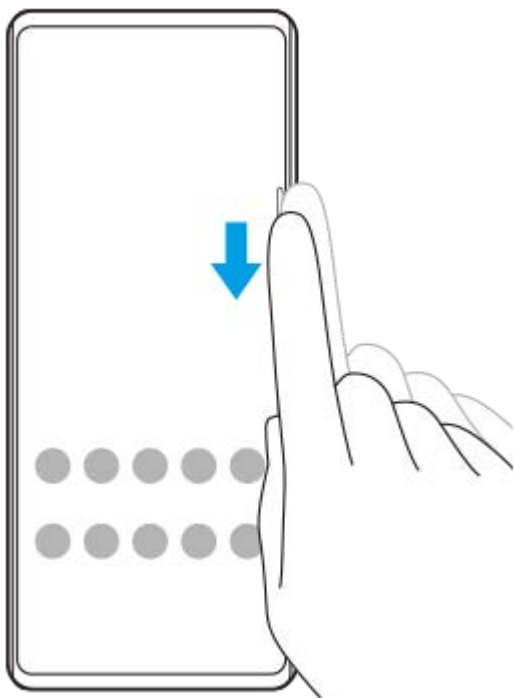

---

#### Related Topic

- [Turning Side sense on or off](#)
- [Setting other Side sense options](#)



Smartphone  
Xperia PRO-I XQ-BE52/XQ-BE62/XQ-BE72

## Setting other Side sense options

---

You can configure how Side sense behaves or customize the menu, etc.  
For example, the following options are available for Side sense.

- Whether to show the Side sense bar on one or both sides of your screen
- The screen actions for gesture

- 1** Find and tap **[Settings] > [Display] > [Advanced]**.
- 2** Tap **[Side sense]**.
- 3** Tap the switch to enable the function.
- 4** Follow the on-screen instructions in the lower part of the screen to edit other Side sense options.

### Hint

- To assign a screen action, such as taking a screenshot, to a gesture, find and tap **[Settings] > [Display] > [Advanced] > [Side sense] > [Gestures]**, select a gesture from among **[Double-tap]**, **[Slide up]**, and **[Slide down]**, and then select an option.

---

### Related Topic

- [Settings menu](#)
- [Turning Side sense on or off](#)
- [Using Side sense](#)

Smartphone

Xperia PRO-I XQ-BE52/XQ-BE62/XQ-BE72

## Using Smart call handling

---

You can handle incoming calls without touching the screen by turning on the Smart call handling function. Once activated, you can handle calls in the following way:

- Answer: bring the device to your ear.
- Reject: shake the device.
- Ringer off: place the device face down.

**1** Find and tap **[Settings] > [System] > [Gestures] > [Smart call handling]**.

**2** Tap the switch to enable or disable the function.

---

### Related Topic

- [Settings menu](#)

Smartphone  
Xperia PRO-I XQ-BE52/XQ-BE62/XQ-BE72

## About this Help Guide

---

This is the Xperia PRO-I Help Guide for the Android 11 software version. If you are not sure which software version your device is running, you can check it in the Settings menu.

For information on common Android features and settings (such as Android basic settings, Wi-Fi settings, home screen settings, content transfer, app drawer navigation, notifications and other Google application features) please refer to [support.google.com/android/](https://support.google.com/android/).

### Note

- System and application updates can present the features in your device in another way than described in this Help Guide. The Android version might not be affected in an update.
- All pictures used as sample pictures in this Help Guide are for illustrative purposes only and were not taken by the actual device.

## To check the current software version and model number of your device

Find and tap [Settings] > [About phone]. The current software version is displayed under [Build number]. The current model number is displayed under [Model].

## Limitations to services and features

Some of the services and features described in this Help Guide may not be supported in all countries or regions, or by all networks or service providers. The GSM International Emergency Number can always be used in all countries, regions, networks and by all service providers, provided that the device is connected to the mobile network. Please contact your network operator or service provider to determine the availability of any specific service or feature and whether additional access or usage fees apply.

The use of certain features and applications described in this guide may require access to the internet. You may incur data connection charges when you connect to the internet with your device. Contact your wireless service provider for more information.

---

### Related Topic

- [Before updating your device](#)
- [Updating your device wirelessly](#)
- [Updating your device using a computer](#)
- [Settings menu](#)

Smartphone  
Xperia PRO-I XQ-BE52/XQ-BE62/XQ-BE72

## Overview

---

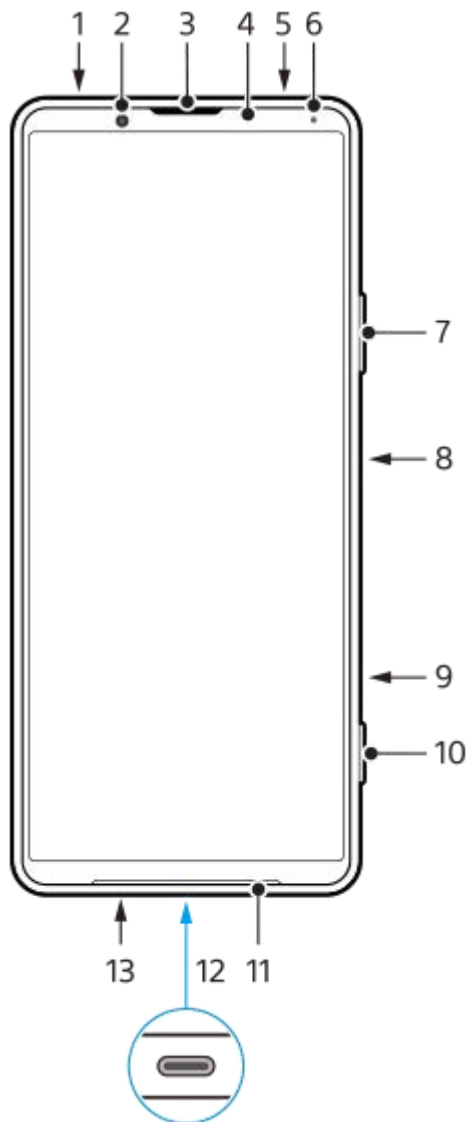

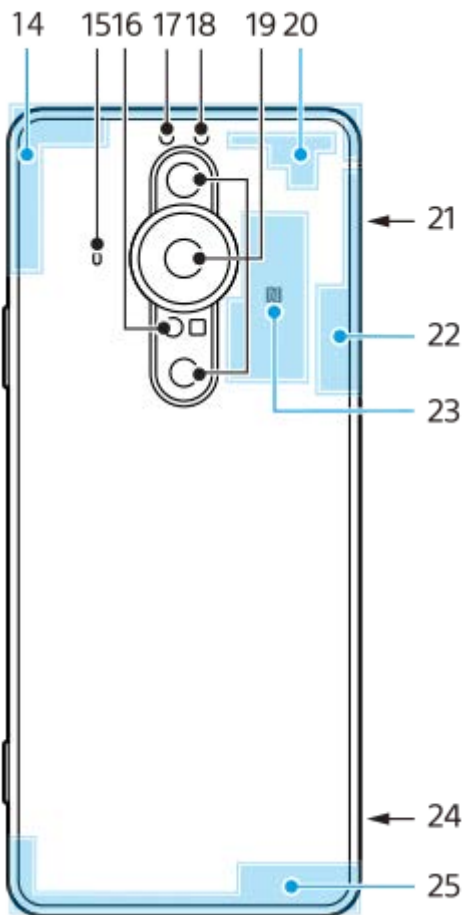

1. Headset jack
2. Front camera
3. Ear speaker/Second loudspeaker
4. Proximity/Light sensor
5. Second microphone
6. Charging/Notification light
7. Volume/Zoom key
8. Power key/Fingerprint sensor
9. Shortcut key

You can quickly launch an assigned app. Video Pro is assigned by default.

10. Camera key
11. Main loudspeaker
12. USB port/Charger

You can view the screen of your device on a TV or other large display device using a USB Type-C® cable. You can also access the internet via a LAN cable by using a commercially available USB-LAN adapter.

**Note**

- When you connect your device to a TV or other large display using a USB Type-C cable, the cable must be compatible with the display port standard. Note that some functions or content on your Xperia device may not be displayable on the TV or display device.
- Some USB-LAN adapters may not work properly.

13. Main microphone
14. Cellular antenna
15. 3rd microphone

To use the 3rd microphone, select [Rear mic (mono)] (for Photo Pro), [Rear (mono)] (for Video Pro), or [Rear] (for Cinema Pro) in the microphone settings. When the 3rd microphone is selected, touch the rear panel as little as possible during recording to avoid noise being recorded.

16. Laser AF sensor
17. Flash LED

18. RGBC IR sensor
19. Main camera
20. Cellular/Wi-Fi antenna
21. Nano SIM/Memory card slot
22. Wi-Fi/Bluetooth/GPS antenna
23. NFC detection area
24. Strap hole
25. Cellular antenna

F-703-100-11 Copyright 2021 Sony Corporation

Smartphone  
Xperia PRO-I XQ-BE52/XQ-BE62/XQ-BE72

## Assembly - Dual SIM

Your device only supports nano SIM cards. Dual SIM devices support the use of either two nano SIM cards or a nano SIM card and a memory card.

### Note

- Even if you insert two SIM cards that support 5G, you can only use 5G on the SIM card set for data traffic. You cannot use 5G on two SIM cards at the same time.
- Unmount the memory card before removing it to prevent loss of data. To remove the memory card safely, find and tap [Settings] > [Storage], and then tap ▲ (Eject icon) beside [SD card].

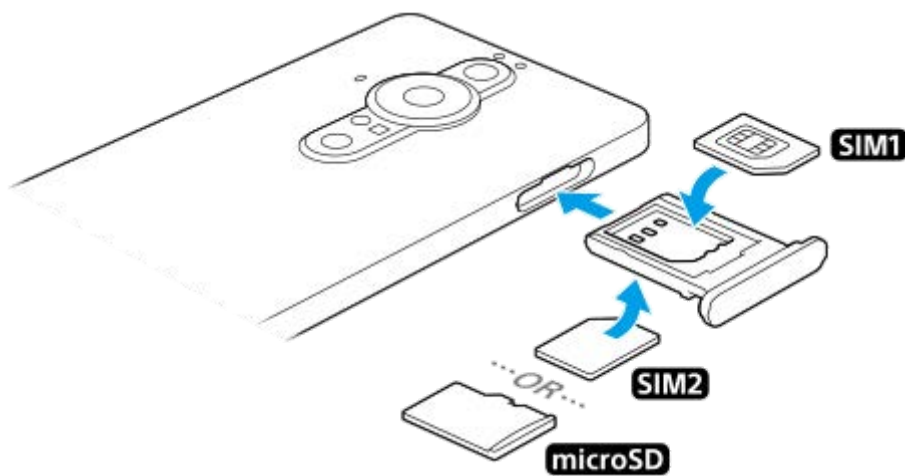

### Note

- Do not cut your SIM card, as this may damage your device.

- 1 Drag out the SIM card tray.
- 2 Place the main SIM card securely in position for SIM1.
- 3 Place either the second SIM card (SIM2) or the memory card securely in the tray, in the correct orientation.
- 4 Gently push the SIM card tray back into the slot until it fits into place.

### Related Topic

- [Finding the IMEI number\(s\) of your device](#)
- [Using a Dual SIM device](#)

Smartphone  
Xperia PRO-I XQ-BE52/XQ-BE62/XQ-BE72

## Using a Dual SIM device

A Dual SIM device enables you to do the following:

- Receive incoming communications via both SIM cards.
- Select the number from which to send outgoing communications, or have the option to select a SIM card each time you place a call.
- Forward calls received via SIM 1 to SIM 2 when SIM 1 is unreachable, and vice versa. This function is called Dual SIM reachability. You must enable it manually.

Before using multiple SIM cards, you need to enable them and select a SIM card which will handle data traffic.

### Hint

- A Dual SIM device works with either one or two SIM cards inserted.

### Enabling or disabling the use of two SIM cards

1. Find and tap [Settings] > [Network & internet] > [Mobile network].
2. Select a SIM card.
3. Tap the [Use SIM] switch to enable or disable the SIM card.
4. Tap  (Back button) to set the other SIM card.

### Renaming a SIM card

1. Find and tap [Settings] > [Network & internet] > [Mobile network].
2. Select a SIM card.
3. Tap  (Edit icon) beside the SIM card name, and then enter a new name.
4. Tap [Save].

### Selecting which SIM card handles data traffic

1. Find and tap [Settings] > [Network & internet] > [Mobile network].
2. Select a SIM card.
3. Tap [Data preference].
4. Select the SIM card you want to use for data traffic.

### Setting the default SIM card for placing a call

1. Find and tap [Settings] > [Network & internet] > [Mobile network].
2. Select a SIM card.
3. Tap [Calls preference].

### Enabling the Dual SIM reachability function

1. Launch the Phone app.
2. Tap  (More icon) > [Settings] > [Calling accounts] > [Dual SIM reachability].
3. Tap the switch to enable the function.
4. Follow the on-screen instructions to complete the procedure.

### Note

- The Dual SIM reachability function may not be available depending on the combination of network operators that provided the SIM cards.



## Hint

- If you set one SIM card for calling and the other SIM card for data communications, you may not be able to access the internet while talking on the phone. In this case, turn on the [Data during calls] switch of the SIM card for calling. You will now be able to perform data communications even during calls.
- If the Dual SIM reachability function does not work after you enable it, check that you have entered the phone numbers correctly for each SIM card. In some cases, the numbers are detected automatically during setup. Otherwise, you are prompted to enter them manually.

---

## Related Topic

- [Settings menu](#)
- [Assembly - Dual SIM](#)

Smartphone

Xperia PRO-I XQ-BE52/XQ-BE62/XQ-BE72

## Screen protection

---

Screen covers and protectors may help you protect your device against damage. We recommend you use only those screen covers intended for your Xperia device. The use of third-party screen protection accessories may prevent your device from working correctly by covering sensors, lenses, speakers, or microphones and can invalidate the warranty.

Smartphone  
Xperia PRO-I XQ-BE52/XQ-BE62/XQ-BE72

## Starting your device for the first time

---

It is recommended that you charge the battery for at least 30 minutes before starting up your device for the first time. You can still use your device while it is charging.

The first time you start your device, a setup guide helps you to configure basic settings, personalize your device, and sign in to your accounts, for example a Google account.

- 1 Long press the power key until your device vibrates.

### To turn off the device

1. Long press the power key until the options menu opens.
2. Tap [Power off].

#### Note

- It may take a while for the device to shut down.

---

### Related Topic

- [Charging your device](#)

Smartphone

Xperia PRO-I XQ-BE52/XQ-BE62/XQ-BE72

## Setting up a Google account on your device

---

Your device from Sony runs on the Android platform developed by Google. A range of Google applications and services is available on your device when you purchase it, for example, Gmail, Google Maps, YouTube, and the Google Play application. To get the most out of these services, you need a Google account. For example, a Google account enables you to do the following:

- Download and install applications on Google Play.
- Synchronize your email, contacts, and calendar using Gmail.
- You can back up, restore, and transfer your data from another device to your device.
- Chat with friends using the Google Duo application.
- Synchronize your browsing history and bookmarks using the Chrome web browser.
- Identify yourself as the authorized user after a software repair using Xperia Companion.
- Remotely find, lock, or clear a lost or stolen device using the Find My Device services.

For more information, go to [support.google.com/](https://support.google.com/).

- 1 Find and tap [Settings] > [Accounts] > [Add account] > [Google].**
- 2 Follow the on-screen instructions to create a Google account, or sign in if you already have an account.**

---

### Related Topic

- [Synchronizing data using a Google account \(from Android\)](#)
- [Settings menu](#)

Smartphone  
Xperia PRO-I XQ-BE52/XQ-BE62/XQ-BE72

## Transferring content using the Xperia Transfer 2 app (from Android/iOS)

You can transfer data, such as music, photos, videos, contacts, device settings, schedules, call history, SMS/MMS, and more using the Xperia Transfer 2 app.



You can transfer content by connecting your device (transfer destination device) to another device (transfer source device) with a USB cable. To transfer content from an iOS device, use a USB OTG adapter together with the USB cable. You can also connect devices using a Wi-Fi connection.

**(A):** USB OTG adapter (Use a USB OTG adapter to transfer content from an iOS device.)

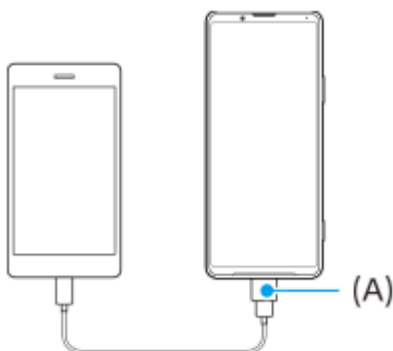

- 1 On your device (transfer destination device), open the Xperia Transfer 2 app.**  
To transfer content from an Android OS device, download and open the Xperia Transfer 2 app on the other device (transfer source device).
- 2 Follow the on-screen instructions to connect and transfer content.**

Smartphone  
Xperia PRO-I XQ-BE52/XQ-BE62/XQ-BE72

## Synchronizing data using a Google account (from Android)



You can transfer data by synchronizing with a Google account.

To transfer content from another Android device (transfer source device) to your device (transfer destination device), first log in to the Google account on the other device and back up your data. Then, set the same Google account on your device and transfer content by synchronizing the data. There are several ways to synchronize data, depending on the kind of content that you want to back up and synchronize.

For more information, go to [support.google.com/android/](https://support.google.com/android/) or refer to the app help.

The storage capacity of Google Drive may differ according to your subscription plan. Find the capacity information for Google Drive by tapping  (Menu icon) > [Storage].

### Gmail, Calendar, and Contacts



1. Find and tap [Settings] > [Accounts].
2. If there is no Google account set yet, tap [Add account], and then follow the on-screen instructions to add an account.
3. Tap the [Automatically sync app data] switch to enable the function.  
Your Gmail, Calendar, and Contacts will be backed up automatically.

### Images (photos) and videos

You can transfer photos and videos by backing them up from another device using Google Photos.



1. On the other device (transfer source device), back up photos and videos to the Google server using Google Photos, and then turn on the sync settings.
2. On your device (transfer destination device), log in with the same Google account that you are using on the other device.
3. Launch the Google Photos app.  
Photos and videos backed up from the other device can be viewed and edited.  
If you want to save files on the internal storage of your device, you can download them.

### Apps, settings, call history, and SMS/MMS

You can transfer apps, settings, and call history by backing them up to Google Drive automatically from another device.



1. On the other device (transfer source device), turn on the backup setting from the settings menu in Google Drive.

2. When you power on your device (transfer destination device) for the first time, log in with the same Google account that you are using on the other device, and then select the backup data and objects to restore.

#### Hint

- To back up app data automatically, device settings, and call history from your device, find and tap [Settings] > [System] > [Backup], and then tap the back-up switch.

## Music and other document files

Music and other document files are transferred by backing them up to Google Drive manually from the other device.



1. On the other device (transfer source device), launch the Music app or File app.
2. Select a file to upload to Google Drive, and then save it to Google Drive using the Share function.
3. On your device (transfer destination device), log in with the same Google account that you are using on the other device.
4. Launch the Google Drive app.  
The files backed up from the other device will be viewed or downloaded.

#### Hint

- To back up music and other document files from your device, touch and hold the file you want to back up, and then tap  (Share icon) to save it to Google Drive.

---

### Related Topic

- [Settings menu](#)
- [Setting up a Google account on your device](#)

Smartphone  
Xperia PRO-I XQ-BE52/XQ-BE62/XQ-BE72

## Transferring content using a computer (from Android)

You can transfer a large amount of data to your device (transfer destination device) from another Android device (transfer source device) using a computer.



- 1 Connect both your device (transfer destination device) and the other device (transfer source device) to a computer using a USB cable.**

On your device, drag down the status bar, tap the USB connection setting notification, and then tap [Tap for more options.] > [File Transfer].

- 2 On the computer, select which files to transfer from the other device, and then copy and paste or drag and drop the files to a location on your device.**

When you copy files from the other device to your device, make sure that the folder names are the same on both devices.

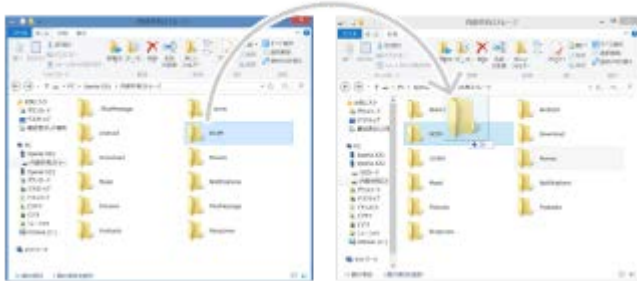

### Note

- Always use a USB cable intended for your specific Xperia model, and make sure it is completely dry.



Smartphone  
Xperia PRO-I XQ-BE52/XQ-BE62/XQ-BE72

## Transferring content using an SD card (from Android)

You can transfer photos, videos, music, and other document files from another Android device using an SD card.



- 1 On the other device (transfer source device), copy the data that you want to transfer to an SD card using the Storage function in the Settings menu or the Files app.**

To copy contacts to an SD card, launch the Contacts app, and then export the contacts to the SD card.

### Note

- Check that the SD card can be used on both your device and the other device in advance.

- 2 Insert the SD card to which you copied the data into your device (transfer destination device), and then transfer the data to your device's internal storage.**

To copy contacts from the SD card, launch the Contacts app, and then import them.



- 3 Check the transferred data using the appropriate app.**

Smartphone

Xperia PRO-I XQ-BE52/XQ-BE62/XQ-BE72

## Making sure your device is protected

---

Your device includes security options, strongly recommended in case of loss or theft.

There are several ways to protect your device, as listed below. Find and tap [Settings], and then search for the settings at the top of the screen.

- Screen lock
- Fingerprint Manager
- SIM card lock

You can register fingerprints to use as a security method for unlocking your device or authenticating purchases. Find and tap [Settings] > [Security] > [Fingerprint Manager], and then follow the on-screen instructions.

For more information, go to [support.google.com/android/](https://support.google.com/android/).

### Note

- When using a security option to protect your device, it is crucial to remember the details provided at set up.

---

### Related Topic



- [Settings menu](#)
- [Finding, locking, or erasing a lost device](#)

Smartphone  
Xperia PRO-I XQ-BE52/XQ-BE62/XQ-BE72

## Finding the IMEI number(s) of your device

Your device has one or two unique identification numbers that are referred to as IMEI or Product ID. You should keep a copy of this. You may require it if your device is stolen or when contacting support.

### Viewing your IMEI number(s) using the dialpad

1. Find and tap  (Phone icon).
2. Tap  (Dialpad icon).
3. Enter \*#06# into the dialpad. The IMEI number(s) are displayed automatically.

### Viewing your IMEI number(s) on the tray

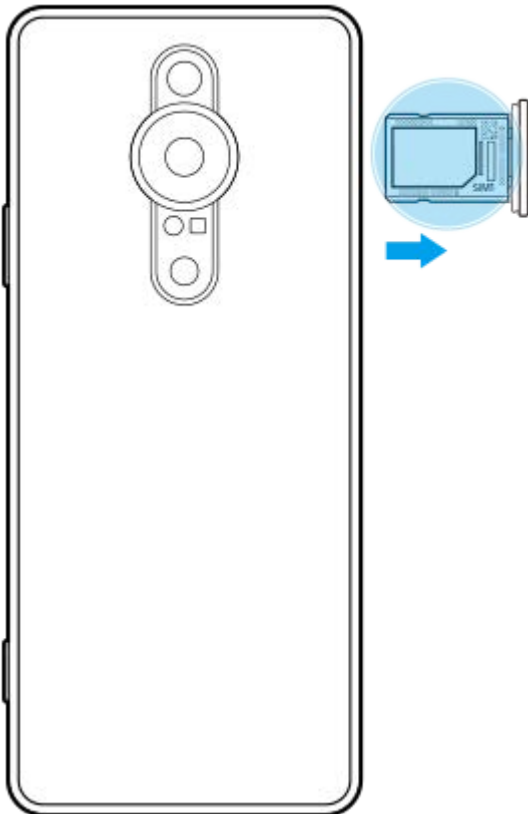

1. Drag out the SIM card tray. The IMEI number(s) is(are) displayed on the tray.

Smartphone  
Xperia PRO-I XQ-BE52/XQ-BE62/XQ-BE72

## Finding, locking, or erasing a lost device

---

Google offers a location and security web service called “Find My Device”. After you sign in to a Google account, “Find My Device” is turned on by default. If you lose your device, you can use “Find My Device” to find, lock, or erase it. For more information, go to [support.google.com/android/](https://support.google.com/android/).

Smartphone  
Xperia PRO-I XQ-BE52/XQ-BE62/XQ-BE72

## Turning the screen on or off

---

When your screen is turned off, your device can be locked or unlocked, depending on your screen lock setting. The Ambient display feature enables you to view information such as the time and notifications without pressing the power key.

### 1 Briefly press the power key.

#### Hint

- If the Ambient display is set to [Smart activation] or [Show when device is lifted], the screen is turned on automatically when you pick up your device.
- To turn the screen on by pressing the camera key or volume key, tap [Settings] > [System] > [Gestures], and then tap the [Wake up display on keypress] switch to enable the function.

---

#### Related Topic

- [Setting the Ambient display](#)
- [Settings menu](#)

## Home screen

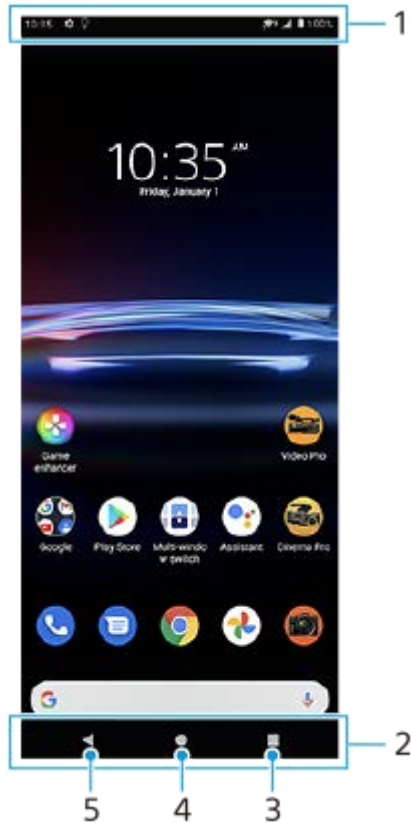

1. Status bar
2. Navigation bar
3. Overview button – Tap to find all open apps.
  - To open another app, tap the overview button, swipe left or right to select the app you want to open, and then tap the app.
  - To close an app, tap the overview button, swipe left or right to select the app you want to close, and then swipe up on the app.
4. Home button – Tap to exit an app and go back to the Home screen.
5. Back button – Tap to go back to the previous screen within an app or close the app.

### Hint

- When the 3 buttons for Home, Back, and Overview are not displayed at the bottom of the screen, find and tap [Settings] > [System] > [Gestures] > [System navigation] > [3-button navigation].

### To open the Quick settings panel

1. Swipe down twice from the top of the screen.

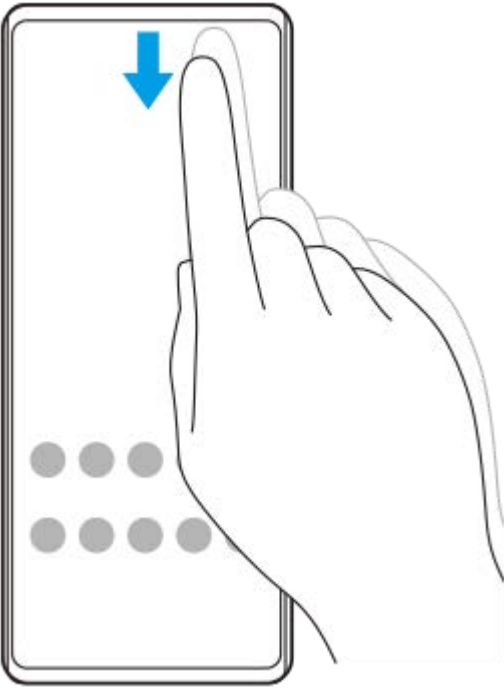

### To view all apps in the app drawer and open an app

1. Swipe up from the bottom of the screen to the top to open the app drawer.

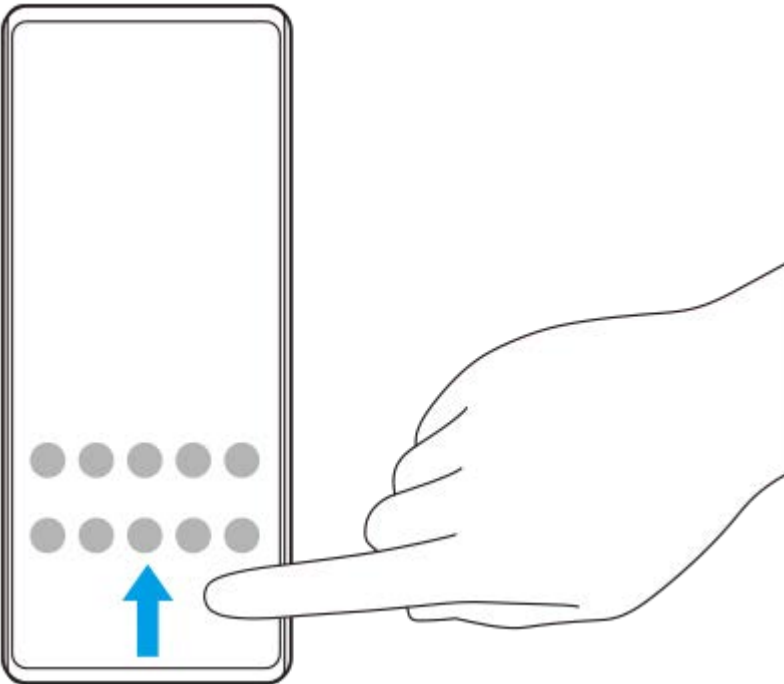

2. Tap the app that you want to open.

### To change your wallpaper

You can change your wallpaper to a preset image or your favorite photo.

1. Touch and hold an empty area on the Home screen, and then tap [Wallpapers].



### Hint

- To add a widget to the Home screen, touch and hold an empty area on the Home screen, and then tap [Widgets].

### Related Topic

- [Settings menu](#)
- [Screen settings](#)



Smartphone

Xperia PRO-I XQ-BE52/XQ-BE62/XQ-BE72

## Adjusting the idle time before the screen turns off

---

When your device is on and left idle for a set period of time, the screen dims and turns off to save battery power. You can change how long your screen stays active before it turns off.

- 1** Find and tap **[Settings] > [Display] > [Screen timeout]**.
  - 2** Select an option.
- 

### Related Topic

- [Settings menu](#)

Smartphone

Xperia PRO-I XQ-BE52/XQ-BE62/XQ-BE72

## Smart backlight control

---

The smart backlight control keeps the screen on as long as the device is held in your hand. Once you put down the device, the screen turns off according to your screen timeout setting.

- 1 Find and tap **[Settings] > [Display] > [Advanced] > [Smart backlight control]**.
  - 2 Tap the switch to enable or disable the function.
- 

### Related Topic



- [Settings menu](#)
- [Adjusting the idle time before the screen turns off](#)

Smartphone  
Xperia PRO-I XQ-BE52/XQ-BE62/XQ-BE72



## One-handed mode

---

Enable One-handed mode to adjust the display size so you can type with one hand more easily.

- 1 Find and tap **[Settings] > [Display] > [Advanced] > [One-handed mode]**.
- 2 Tap the **[One-handed mode]** switch to enable or disable the function.
- 3 To shrink the screen, double-tap  (Home button).  
To exit One-handed mode, double-tap  (Home button) again or tap an empty area on the screen.

### To adjust the position of the screen

- To move the screen to the left side or to the right side: tap  (Left arrow icon) or  (Right arrow icon) accordingly.
- To move the screen upwards or downwards: drag the horizontal stripes at the edge of the resized screen.
- To resize the screen: drag  (Resize screen icon) at the edge of the resized screen.

#### Hint

- You can shrink the screen by using the Side sense menu.

---

### Related Topic

- [Settings menu](#)
- [Using Side sense](#)

Smartphone  
Xperia PRO-I XQ-BE52/XQ-BE62/XQ-BE72

## Taking a screenshot

You can capture still images of any screen on your device as a screenshot. After you take a screenshot, you can view, edit, and share the image. Screenshots you take are automatically saved in your device's internal storage.

- 1 Long press the volume down key (A) and power key (B) at the same time.

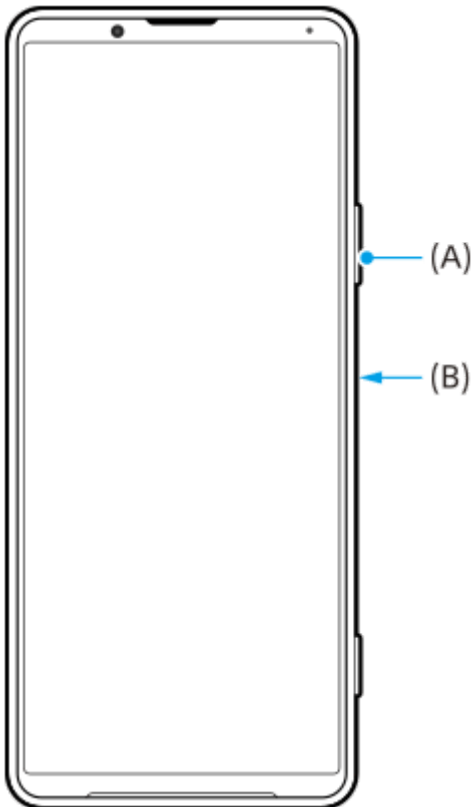

### Hint

- You can assign taking screenshots to a gesture on the Side sense bar. To take a screenshot using the Side sense bar, find and tap [Settings] > [Display] > [Advanced] > [Side sense] > [Gestures], select a gesture from among [Double-tap], [Slide up], and [Slide down], and then tap [Take screenshot].

### To take a screenshot of a recently used app

1. Tap  (Overview button) in the navigation bar.

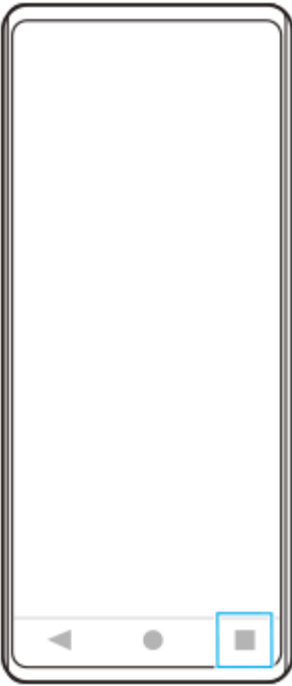

2. Swipe left or right to select the app of which you want to take a screenshot, and then tap [Screenshot].



---

### Related Topic

- [Setting other Side sense options](#)
- [Settings menu](#)



Smartphone  
Xperia PRO-I XQ-BE52/XQ-BE62/XQ-BE72

## Recording your device screen

You can record a video of your device screen. Recorded videos are automatically saved in your device's internal storage.

**1** Swipe down twice from the top of the screen to open the Quick settings panel.

**2** Swipe left or right to find  (Screen Record icon), and then tap it.

If you cannot find the icon in the Quick settings panel, tap  (Edit icon), and then drag and drop  (Screen Record icon) into the upper part of the screen.

**3** Follow the on-screen instructions to start recording the screen.

To stop recording, drag down the status bar to open the notification panel, and then tap the Screen recorder notification.

### Note

- This Screen recorder and similar functions provided by other apps cannot be used at the same time as the [Screenshot] function or the [Record] function of the Game enhancer app.
- You may not be able to record your device screen depending on the application design.

### Related Topic

- [Home screen](#)

Smartphone  
Xperia PRO-I XQ-BE52/XQ-BE62/XQ-BE72

## Alarm

You can set one or several alarms and use any sound file saved on your device as the alarm signal. The alarm does not sound if your device is turned off.

- 1 Find and tap [Clock] > [Alarm].



- 2 Tap **+** (Add item icon).
- 3 Select the desired value.
- 4 Tap [OK].

### Hint

- To add a clock widget to the Home screen, touch and hold an empty area on the Home screen, tap [Widgets], and then touch and hold the desired clock.

### Related Topic

- [Date and time](#)

Smartphone  
Xperia PRO-I XQ-BE52/XQ-BE62/XQ-BE72

## Scanning QR codes

---

You can scan QR codes using Photo Pro.

- 1 Find and tap  (Photo Pro icon), and then switch the shooting mode to [BASIC] (Basic).
- 2 Point the camera at the QR code, and then tap the notification that appears.  
If the notification does not appear, drag down the status bar to open the notification panel, and then confirm it.

### To turn the [QR Code reader] function on

1. Find and tap  (Photo Pro icon), and then switch the shooting mode to [BASIC] (Basic).
2. Tap [MENU].
3. Tap [QR Code reader] > [On].
4. Close the menu.  
The setting is saved.

#### Hint

- To display the QR code notification on the Photo Pro app screen, find and tap [Settings] > [Apps & notifications] > [Photography Pro] > [Notifications] > [QR Code reader], and then tap the [Pop on screen] switch to enable the function with [Default] selected.

---

### Related Topic

- [Taking a photo or recording a video](#)
- [Settings menu](#)



Smartphone  
Xperia PRO-I XQ-BE52/XQ-BE62/XQ-BE72

## Notification light

---

The notification light informs you about battery status and some other events. The notification light is enabled by default but can be disabled manually.



### Note

- If the notification light is disabled, it only lights up or flashes when there is a battery status warning, such as when the battery level goes below 15 percent.

- 1 Find and tap **[Settings] > [Apps & notifications] > [Configure notifications]**.
- 2 Tap the **[Use LED light to show incoming notifications]** switch to enable or disable the function.  
You may find the item under **[Advanced]**.

---

### Related Topic

- [Settings menu](#)

Smartphone  
Xperia PRO-I XQ-BE52/XQ-BE62/XQ-BE72

## Status bar and notification panel

Notification icons and status icons are displayed in the status bar at the top of the screen. Notification icons inform you of events, such as new messages. Status icons inform you of statuses, such as the condition of the battery and the signal strength of mobile or Wi-Fi network connections.





1. Notification icons
2. Status icons
3. Status bar

### To view notification content

When you open the notification panel, you can view the content of the displayed notification icons.

1. Drag down the status bar to open the notification panel.

#### Hint

















- To expand and view more information about a notification, tap  (Down arrow icon). Not all notifications are expandable.
- To open the app in the pop-up window from the notification, tap  (Pop-up window icon). Not all apps can be opened in the pop-up window.
- To dismiss a notification from the notification panel, swipe the notification left or right. Not all notifications can be dismissed.
- To change the notification settings, drag a notification left or right to make  (Settings icon) appear and then tap it, or touch and hold the notification.

### Related Topic

- [Notification icons](#)
- [Status icons](#)

Smartphone  
Xperia PRO-I XQ-BE52/XQ-BE62/XQ-BE72

## Status icons

	(Signal strength icon) The mobile network mode is also displayed when sending and downloading mobile data.
	(No signal icon)
	(Data roaming icon) International roaming is in use.
	(Wi-Fi signal icon) A Wi-Fi connection is enabled and data is being transmitted. The number displayed to the left of the icon differs according to the Wi-Fi standard of the current connection.
	(Wi-Fi connection error icon) A Wi-Fi connection is enabled but there is no internet connection. This icon also appears when you are trying to connect to a captive portal network. After a successful login, the cross mark disappears. If Google is blocked in your area, the cross mark may appear even when the device is connected to a network and there is a Wi-Fi working internet connection.
	(Battery status icon)
	(Charging battery icon)
	(STAMINA mode icon)
	(Data Saver icon)
	(Airplane mode icon)
	(Bluetooth icon) Your device is connected to a Bluetooth compatible device.
	(Microphone muting icon)
	(Speakerphone icon)
	(Do Not Disturb icon)
	(Muting icon)
	(Vibrate icon)

	(Alarm icon)
	(GPS icon)

**Note**















- Not all icons that may appear on your device are listed here. This list is for reference purposes only, and changes may be made without notice.

**Related Topic**

- [Charging your device](#)
- [STAMINA mode](#)
- [Controlling data usage](#)
- [Turning the Bluetooth function on or off](#)
- [Volume and vibration](#)
- [Alarm](#)
- [Using location services](#)
- [Notification icons](#)

Smartphone  
Xperia PRO-I XQ-BE52/XQ-BE62/XQ-BE72

## Notification icons

	(New SMS icon)
	(Ongoing call icon)
	(Missed call icon)
	(Phone call on hold icon)
	(Call forward icon) Call forwarding is turned on
	(Downloading data icon)
	(Uploading data icon)
	(Software setup icon) A basic setup of your device is available
	(Install latest software icon) A software update is available
	(System update icon) System updates are available
	(Downloading system update icon)
	(Installing downloaded system update icon)
	(Battery Care icon)
	(Dynamic Vibration icon)
	(More notifications icon) More undisplayed notifications

### Note

- Not all icons that may appear on your device are listed here. This list is for reference purposes only, and changes may be made without notice.

### Related Topic

- [Battery Care](#)

- Using Dynamic Vibration
- Status icons

F-703-100-11 Copyright 2021 Sony Corporation

Smartphone  
Xperia PRO-I XQ-BE52/XQ-BE62/XQ-BE72

## Charging your device

You can charge your device from a wall socket or computer. You can still use your device while charging. If the battery is depleted, it may take up to 10 minutes for your device to respond to the charging. During this time, the screen may remain completely dark, not showing the charging icon. It can take couple of hours for a completely drained battery to be fully charged. Charging speed may be affected by ambient temperature. Always use the original Sony charger and a USB cable intended for your specific Xperia model, since other types of chargers can increase charging time, not charge at all, or may even damage your device.

### Note

- Your device has an embedded, rechargeable battery that can only be replaced by an authorized Sony repair center. Never try to open or take apart the device yourself. Doing so can cause damage and void your warranty.

### Hint

- A wall socket charger will charge your device faster than charging via computer. You can still use your device while charging.

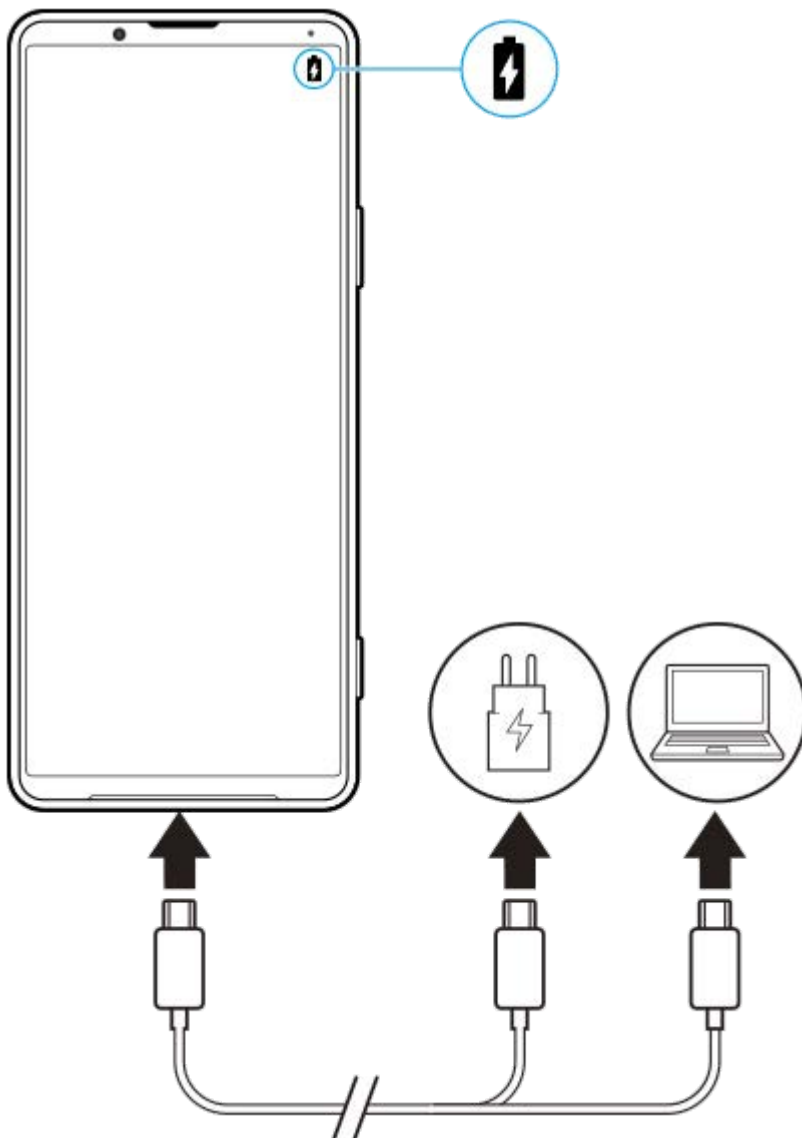

- 1 Connect one end of the USB cable to the charger (or to the USB port of a computer).

**2 Connect the other end of the cable to the USB port on your device.**

The notification light illuminates when charging begins.

**3 When the device is fully charged, disconnect the cable from your device by pulling it straight outwards.**

Make sure not to bend the connector.

### Battery notification light status

- Green: Battery is charging, charge level is greater than 90%
- Orange: Battery is charging, charge level is 15%–90%
- Red: Battery is charging, charge level is less than 15%

#### Note

- It is important to use the USB cable that came with your device, as other types of USB cables can damage your device.

#### Hint

- If the battery is completely depleted, it may take up to 10 minutes before the notification light illuminates and the charging icon appears.

---

### Related Topic

- [Battery and power management](#)



Smartphone  
Xperia PRO-I XQ-BE52/XQ-BE62/XQ-BE72

## Battery Care

Battery Care increases the lifespan of your battery. This feature detects your charging patterns and estimates the start and end time of your regular charging period. Your device charges at a regular speed until it is 90% charged, and then the charging rate is controlled so that your battery reaches 100% just before you disconnect the charger. You can manually customize the start and end times of the charging period. For a better battery lifespan, you can also set a charging limit so that the battery always only charges up to 80% or 90%.

### Note

- Battery Care will not control the charging rate until it detects a regular charging cycle of at least 4 hours over a period of several days.

- 1 Find and tap **[Settings] > [Battery] > [Battery Care]**.
- 2 Tap the switch to enable or disable **Battery Care**.
- 3 Follow the on-screen instructions, and then select an option.  
[Auto] is selected by default.

### Hint

- Learned patterns of the regular charging cycle are saved by Battery Care. Even if the function has been disabled, it adopts to the learned patterns after enabling the function again.

### Related Topic

- [Settings menu](#)

Smartphone

Xperia PRO-I XQ-BE52/XQ-BE62/XQ-BE72

## STAMINA mode

---

The STAMINA mode prolongs the time until the battery needs charging by disabling some functions of the device. When you turn on the STAMINA mode, the display switches to the Dark theme mode.

Depending on the STAMINA level, different features will be restricted or disabled in order to reduce battery consumption. These include rendering performance, screen brightness, image enhancement, and GPS while the screen is off. Synchronizing of background app data or streaming may be disabled for some applications.

You can set the STAMINA mode to turn on or off automatically according to the battery level. Follow the on-screen instructions for detailed settings.

**1** Find and tap **[Settings] > [Battery] > [STAMINA mode]**.

**2** Tap **[Turn on now]**.

### Hint

- You can exempt applications from being optimized by STAMINA mode in the Power-saving feature menu.

---

### Related Topic

- [Settings menu](#)

Smartphone

Xperia PRO-I XQ-BE52/XQ-BE62/XQ-BE72

## Battery and power management

---

Your device has an embedded battery. To get the most use from it, keep track of the power consumed by different applications and features.

You can also use Battery Care to increase the battery's lifetime. The Power-saving feature is activated by default to restrict applications from using battery power in the background. If you do not want an application to be affected, you can make it exempt in the Power-saving feature menu. Phone calls and SMS are not affected.

### Note

- System updates may change the power-saving features available on your device.

### General usage tips to improve battery performance

The following tips can help you improve battery performance:

- Lower the screen brightness level.
- Turn off Bluetooth, Wi-Fi, and location services when you do not need these features.
- Turn off your device or use Airplane mode if you are in an area with no or low network coverage. Otherwise, your device repeatedly scans for available networks, and this consumes power.
- Use a Wi-Fi network instead of roaming when abroad. Roaming is scanning for your home network and puts additional demands on your battery as your device must transmit with a higher output power.
- Change the synchronization settings for your email, calendar, and contacts.
- Check the applications that have a high battery consumption and consider the battery saving tips provided on your device for these applications.
- Change the notification level for an application.
- Turn off the location-sharing permission for an application.
- Uninstall applications that you are not using.
- Use a Sony original handsfree device to listen to music. Handsfree devices consume less battery than your device's loudspeakers.
- Restart your device every now and then.

### To review your battery consumption

1. Find and tap [Settings] > [Battery] to view the estimated remaining battery percentage and battery time.
2. Tap  (More icon) > [Battery usage] to view a list of applications and features that have consumed battery power.

---

### Related Topic

- [Charging your device](#)
- [Checking battery consumption for applications](#)
- [Battery Care](#)
- [Screen settings](#)
- [Turning the Bluetooth function on or off](#)
- [Using location services](#)
- [Restarting and resetting your device](#)
- [Settings menu](#)

Smartphone

Xperia PRO-I XQ-BE52/XQ-BE62/XQ-BE72

## Checking battery consumption for applications

---

You can check battery consumption for applications, and change the settings if necessary.

- 1 Find and tap [Settings] > [Apps & notifications].**
- 2 Select an application and review its battery consumption under [Battery].**  
You may find the item under [Advanced].

---

### Related Topic

- [Settings menu](#)

Smartphone

Xperia PRO-I XQ-BE52/XQ-BE62/XQ-BE72

## Before updating your device

---

You should update the software on your device to get the latest functionality, enhancements, and bug fixes in order to ensure optimal performance. When a software update is available,  (System update icon) appears in the status bar. You can also check for new updates manually.

The easiest way to install a software update is to do it wirelessly from your device. However, some updates are not available for wireless download. In this case, you can use Xperia Companion. Visit the Sony customer support website and search for Xperia Companion to download, install and check the system requirements for it.

Before updating your device, consider the following:

- Ensure you have sufficient storage capacity.
- System and application updates can present the features on your device in another way than described in this Help Guide. The Android version might not be affected after an update.

### To check for new software

1. Find and tap [Settings] > [System] > [Advanced] > [Software update].
- 

### Related Topic

- [Updating your device wirelessly](#)
- [Updating your device using a computer](#)
- [Settings menu](#)

Smartphone

Xperia PRO-I XQ-BE52/XQ-BE62/XQ-BE72

## Updating your device wirelessly

---

Use the Software update application to update your device software wirelessly. The updates you can download over a mobile network depend on your operator. It is recommended to use a Wi-Fi network instead of a mobile network to download new software so that you can avoid data traffic costs.

- 1 Find and tap [Settings] > [System] > [Advanced] > [Software update].
- 2 Follow the on-screen instructions.

### To set up automatic download of system updates

1. Find and tap [Settings] > [System] > [Advanced] > [Software update].
2. Tap  (More icon) > [Settings] > [Auto update system].
3. Select the preferred option.

### To enable or disable automatic updates for applications

1. Find and tap [Settings] > [System] > [Advanced] > [Software update].
2. Tap  (More icon) > [Settings] > [Auto update apps].
3. Select the preferred option.

---

#### Related Topic

- [Before updating your device](#)
- [Settings menu](#)
- [Updating your device using a computer](#)

Smartphone  
Xperia PRO-I XQ-BE52/XQ-BE62/XQ-BE72

## Updating your device using a computer

---

- 1** Connect your device to the computer using a USB cable.
- 2** Drag down the status bar, and then tap the USB connection setting notification.
- 3** Tap [Tap for more options.], and then tap [File Transfer].
- 4** **Computer: Open Xperia Companion, if it is not automatically launched.**  
Make sure that the computer can access the internet.  
If a new software update is detected, a pop-up window appears.
- 5** Follow the on-screen instructions to run the relevant software updates.

### Note

- If Xperia Companion is not installed on your computer, visit the Sony customer support website and search for Xperia Companion to download it.

---

### Related Topic

- [Before updating your device](#)
- [Updating your device wirelessly](#)

Smartphone

Xperia PRO-I XQ-BE52/XQ-BE62/XQ-BE72

## Restarting and resetting your device

You can force your device to restart or shut down if it stops responding or will not restart normally. No settings or personal data get deleted.

You can also reset your device to its original factory settings. This procedure is sometimes necessary if your device stops functioning properly, but note that you should first back up your data, as resetting your device will erase all your data from your device.

If your device fails to turn on or you want to reset your device's software, you can use Xperia Companion to repair your device. For more information on downloading and using Xperia Companion, search for Xperia Companion on the Sony customer support website.

### Restarting your device

#### Note

- Your device may fail to restart if the battery level is low. Connect your device to a charger and try restarting again.

1. Long press the power key.
2. In the menu that opens, tap [Restart].  
The device restarts automatically.

### Forcing the device to restart or shut down

1. Long press the power key and the volume up key at the same time until your device vibrates.
2. Depending on whether you wish to force the device to restart or shut down, proceed as follows.
  - If you wish to force restart the device: Release the keys at this point. The device restarts.
  - If you wish to force shut down the device: Continue pressing the keys. After a few more seconds, the device vibrates three times and turns off.

#### Hint

- If your device does not turn on, forcing the device to restart may resolve the issue.

### Performing a factory data reset

#### Note

- To avoid permanent damage to your device, do not interrupt a factory data reset procedure.
- Back up any data saved to the internal memory of your device. Resetting will erase all your data from your device.

1. Find and tap [Settings] > [System] > [Advanced] > [Reset options].
2. Tap [Erase all data (factory reset)] > [Erase all data].
3. If required, draw your screen unlock pattern or enter your screen unlock password or PIN to continue.
4. To confirm, tap [Erase all data].

#### Hint

- Your device does not revert to an earlier software version of Android when you perform a factory data reset.



- [Repairing the device software using Xperia Companion](#)
- [Settings menu](#)

F-703-100-11 Copyright 2021 Sony Corporation

Smartphone

Xperia PRO-I XQ-BE52/XQ-BE62/XQ-BE72

## Repairing the device software using Xperia Companion

You can use Xperia Companion to repair your device's software. If you forget your screen unlock password, PIN or pattern, you can use the device repair feature in Xperia Companion to erase the security layer. You need to provide your Google account login details to perform this operation. By running the repair feature, you reinstall software for your device and you may lose some personal data in the process.

If your device seems to have frozen, restarts repeatedly, or does not start at all after you update the Xperia software, after you perform a software repair, or after a factory data reset, try forcing the device to shut down and then turning it back on. If the problem persists, force the device to shut down and then perform a software repair.

### Note

- Before performing a software repair, make sure you know your Google account username and password. Depending on your security settings, you may need to enter them in order to restart the device after a software repair.

- 1 **Make sure that Xperia Companion is installed on the computer.**
- 2 **Open the Xperia Companion software on the computer and click [Software repair] on the main screen.**
- 3 **Follow the instructions that appear on the screen to reinstall the software and complete the repair.**

### Related Topic

- [Restarting and resetting your device](#)

Smartphone  
Xperia PRO-I XQ-BE52/XQ-BE62/XQ-BE72

## Resetting your applications

---

You can reset an application or clear application data if your application stops responding or causes issues with your device. Resetting application preferences does not delete any application data from your device.

- 1 Find and tap [Settings] > [Apps & notifications].
- 2 Tap the number of apps to see all apps.
- 3 Tap ⋮ (More icon) > [Reset app preferences] > [Reset apps].

### To clear application data

1. Find and tap [Settings] > [Apps & notifications].
2. Select an application or service, and then tap [Storage & cache] > [Clear storage] > [OK].

### To clear application cache

1. Find and tap [Settings] > [Apps & notifications].
2. Select an application or service, and then tap [Storage & cache] > [Clear cache].

### To clear the application default setting

1. Find and tap [Settings] > [Apps & notifications].
2. Select an application or service, and then tap [Advanced] > [Open by default] > [Clear defaults].

#### Note

- The option to clear the application data, cache, or default setting is not available for every application or service.

---

### Related Topic

- [Settings menu](#)

Smartphone  
Xperia PRO-I XQ-BE52/XQ-BE62/XQ-BE72

## Viewing the memory status

---

The internal storage stores downloaded or transferred content along with personal settings and data, and it tends to fill up as a result of normal usage. If the device starts to slow down, or applications suddenly shut down, you should consider the following:

- Close running applications that you are not using.
- Uninstall downloaded applications that you do not use.
- Transfer photos, videos, and music from the internal memory to the removable memory card or Google service.

### Note

- You can purchase a memory card separately.
- If your device cannot read content on the memory card, you may need to format the card. Note that when you format the card, all content is erased.

## To view the memory status

1. Find and tap [Settings] > [Storage].
- 

### Related Topic

- [Freeing up space on the internal storage](#)
- [Stopping applications and services from running](#)
- [Synchronizing data using a Google account \(from Android\)](#)
- [Transferring content using an SD card \(from Android\)](#)
- [Formatting the memory card](#)
- [Settings menu](#)

Smartphone  
Xperia PRO-I XQ-BE52/XQ-BE62/XQ-BE72

## Freeing up space on the internal storage

---

If the device starts to slow down, or applications suddenly shut down, freeing up space on the internal storage may solve the problem. Delete files and uninstall apps that you are not using to free up space.

**1 Find and tap [Settings] > [Storage].**

**2 Tap [Manage storage].**

If you have a memory card inserted, select [Internal shared storage] > [Manage storage].

**3 Select the Browse tab.**

**4 Delete folders or files, or uninstall apps.**

- To delete folders or files, select the internal storage folder, select a folder or file to delete, tap **⋮** (More icon), and then delete it.
- To uninstall apps, select the apps folder, tap **⋮** (More icon) for an app that you do not use, and then uninstall it.

---

### Related Topic

- [Settings menu](#)
- [Viewing the memory status](#)

Smartphone

Xperia PRO-I XQ-BE52/XQ-BE62/XQ-BE72

## Stopping applications and services from running

---

If the performance of your device or apps is not optimal, try stopping apps and services from running.

- 1 Find and tap **[Settings]** > **[Apps & notifications]**.
  - 2 Select an application or service, then tap **[Force stop]** > **[OK]**.
- 

### Related Topic

- [Settings menu](#)
- [Viewing the memory status](#)

Smartphone

Xperia PRO-I XQ-BE52/XQ-BE62/XQ-BE72

## Formatting the memory card

---

If your device cannot read content on the memory card, format the memory card on your device.

**1 Find and tap [Settings] > [Storage] > [SD card].**

Select an app, if prompted.

**2 Tap  (More icon) > [Storage settings] > [Format], and then perform formatting on the next confirmation dialog.**

### Note

- All content on the memory card gets erased when you format it. Make sure you first make backups of all data that you want to save.

---

### Related Topic

- [Settings menu](#)

Smartphone

Xperia PRO-I XQ-BE52/XQ-BE62/XQ-BE72

## Mobile data connection

---

You need the correct internet settings to access the internet with a mobile data connection.

- For most mobile networks and operators, these settings come pre-installed on your device so that you can start using the internet right away.
  - You can manually check for updates to your internet settings. If you change or delete an internet setting by mistake, reset the internet settings.
  - Find and tap [Settings] > [Network & internet] > [Mobile network], and then select a SIM card name for more mobile network options.
- 

### Related Topic

- [Settings menu](#)



Smartphone

Xperia PRO-I XQ-BE52/XQ-BE62/XQ-BE72

## Increasing Wi-Fi® signal strength

---

There are a number of things you can do to improve Wi-Fi reception:

- Move your device closer to the Wi-Fi access point.
  - Move the Wi-Fi access point away from any potential obstructions or interference.
  - Do not cover the Wi-Fi antenna area of your device.
- 
- 

### Related Topic

- [Overview](#)

Smartphone

Xperia PRO-I XQ-BE52/XQ-BE62/XQ-BE72

## Controlling data usage

You can keep track of the amount of data transferred to and from your device over your mobile data or Wi-Fi connection during a given period. For example, you can view the amount of data used by individual applications. For data transferred over your mobile data connection, you can also set data usage warnings and limits to avoid additional charges.

### Helping reduce data usage

1. Find and tap [Settings] > [Network & internet] > [Data Saver].  
You may find the item under [Advanced].
2. Tap the switch to enable the function.

### Setting a data usage warning or a mobile data limit

1. Make sure that mobile data traffic is turned on.
2. Find and tap [Settings] > [Network & internet] > [Mobile network].  
If you are using two SIM cards, select a SIM card.
3. Tap [Data warning & limit].  
You may find the item under [Advanced].
4. Depending on whether you want to set a data warning or a data limit, proceed as follows.
  - To set a data usage warning, tap the [Set data warning] switch to enable the function, and then tap [Data warning] to change the warning level.
  - To set a mobile data limit, tap the [Set data limit] switch to enable the function, and then tap [Data limit] to change the data usage limit.

#### Hint

- You can set the date when the usage cycle resets. Under [Data warning & limit], tap [Mobile data usage cycle], and then set the reset date.

#### Note

- Once your mobile data usage reaches the set limit, mobile data traffic on your device gets turned off automatically.

### Checking your data usage

1. Find and tap [Settings] > [Network & internet].
2. Depending on whether you want to check mobile data usage or Wi-Fi data usage, proceed as follows.
  - To check mobile data usage, tap [Mobile network] > [App data usage].  
If you are using two SIM cards, select a SIM card, and then tap [App data usage].
  - To check Wi-Fi data usage, tap [Wi-Fi] > [Wi-Fi data usage].

### Controlling the data usage of individual applications

1. Find and tap [Settings] > [Apps & notifications].
2. Tap the application that you want to control, and then tap [Mobile data & Wi-Fi].
3. Edit the options as desired.

#### Note

- The performance of individual applications may be affected if you change the related data usage settings.

---

---

## Related Topic

- [Settings menu](#)

F-703-100-11 Copyright 2021 Sony Corporation

Smartphone  
Xperia PRO-I XQ-BE52/XQ-BE62/XQ-BE72

## Settings menu

View and change settings for your device from the Settings menu.

- 1 **Swipe up from the bottom of the screen to the top, and then find [Settings].**

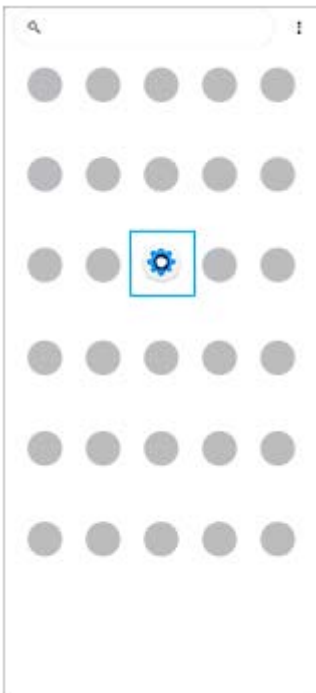

- 2 **Tap [Settings], and then select the desired menu.**

If you are not sure which menu to select, you can search by entering a keyword into the [Search settings] field.

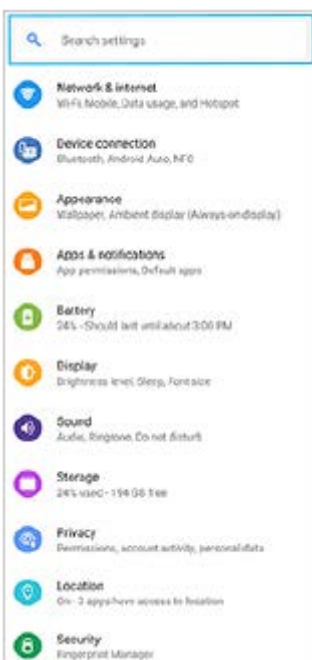

## To open the Settings menu from the Quick settings panel

1. Swipe down twice from the top of the screen.

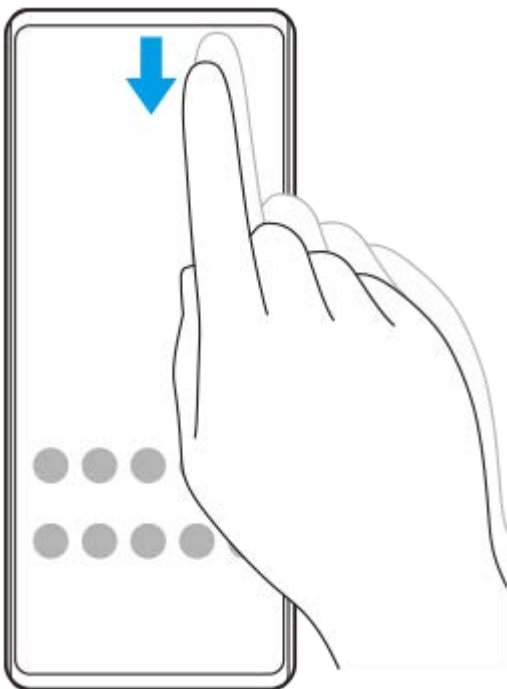



2. Find  (Settings icon).



3. Tap  (Settings icon).

### Hint

- When the 3 buttons for Home, Back, and Overview are not displayed at the bottom of the screen, find and tap [Settings] > [System] > [Gestures] > [System navigation] > [3-button navigation].
- To view information about your device, find and tap [Settings] > [About phone].
- If you select the wrong language and cannot read the menu text, find and tap  (Settings icon) >  (System menu icon). Then, select the text beside  (Keyboard icon) and select the first entry in the menu that opens. You can now select the language you want.

### Related Topic

- [Volume and vibration](#)
- [Sounds and tones](#)
- [Screen settings](#)
- [Date and time](#)



Smartphone  
Xperia PRO-I XQ-BE52/XQ-BE62/XQ-BE72

## Volume and vibration



---

The volume and vibration can be changed either by using the volume keys or by changing a setting. You can change the ring, media, alarm, and in-call volumes. Additionally, you can set your device to vibrate.

### Note

- App settings can override the selected volume and vibration settings.

### Changing the volume

1. Press the volume key up or down to change the media volume.  
To quickly turn the media volume on or off, tap  (Media volume icon).
2. To change the in-call, ring and notification, or alarm volumes, tap  (Adjust volume icon).  
Use each slider to adjust the volume. Tap [See more] for more options.

### Activating the vibrating mode

1. Press the volume key up or down.
2. Tap the icon displayed above the slider one or more times until  (Vibrate icon) appears.

### Activating sound with vibration for incoming calls

1. Find and tap [Settings] > [Sound] > [Vibrate for calls].
2. Select an option.

---

### Related Topic

- [Settings menu](#)

Smartphone  
Xperia PRO-I XQ-BE52/XQ-BE62/XQ-BE72

## Sounds and tones

### Setting the ringtone

You can set different ringtones for each SIM card. You can also select a desired music file as a ringtone.

1. Find and tap [Settings] > [Sound].
2. Select [Phone ringtone - SIM 1] or [Phone ringtone - SIM 2].

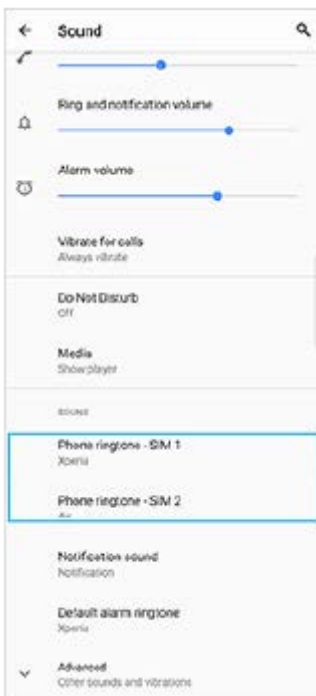

3. Select a sound from the list.  
To select a music file that is not in the list, tap [Add ringtone].

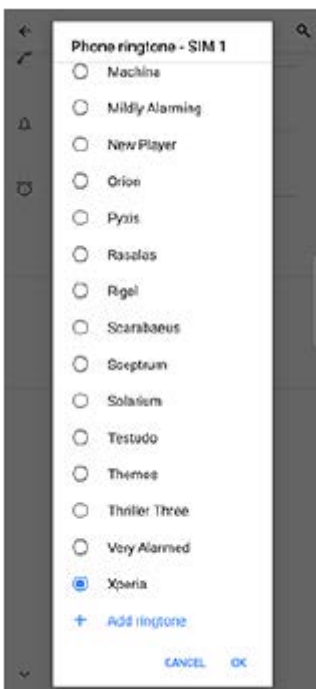



4. To confirm, tap [OK].

## Setting the notification sound

1. Find and tap [Settings] > [Sound] > [Notification sound].
2. Select a sound from the list.  
To select a music file that is not in the list, tap [Add notification].
3. To confirm, tap [OK].

### Hint

- To turn off all ringtone and/or notification sounds and set your device to vibrate only, select [None] from the list.
- To enable or disable other sounds and tones, find and tap [Settings] > [Sound] > [Advanced], and then tap the switches to enable or disable the various sounds and tones.

---

### Related Topic

- [Settings menu](#)

Smartphone  
Xperia PRO-I XQ-BE52/XQ-BE62/XQ-BE72

## Screen settings

---

You can change the screen's behavior, brightness, viewing size, and quality. You can also adjust the image quality of photos and videos.

- 1 Find and tap **[Settings] > [Display]**.
- 2 Tap the setting you want to change.  
Use the sliders, tap the switches, or select options to adjust.

### Main screen settings

- **Image quality settings:** Adjust the quality of photos and videos as displayed on your device.
- **White balance:** Tap the [Set manually] switch to enable changes to the setting, and then select one of the preset settings. You can also use the sliders to adjust the white balance.
- **High refresh rate:** Set the refresh rate to 120 Hz for a smoother display.
- **Brightness level:** Adjust the brightness level with the slider. You can also enable [Adaptive brightness] to automatically optimize brightness based on surrounding light.
- **Dark theme:** You can display the screen with a dark background.
- **Auto-rotate screen:** Set the screen to rotate automatically when the device is turned, or set it to stay in portrait view.
- **Night Light:** [Night Light] switches the color of the screen to amber. This makes it easier to view the screen in a darker setting, and also makes it easier to fall asleep.
- **Prevent accidental operations with screen off:** You can prevent your device from being activated by mistake while placed in a pocket or a bag.

#### Note

- When the STAMINA mode is turned on, [High refresh rate] cannot be used.
- Avoid displaying very bright or static images for a long period of time. This may cause an afterimage or coloring to remain on the screen.

#### Hint

- [Video image enhancement] is available only for certain applications.
- Even if the Auto-rotate screen function is disabled, you can rotate the screen manually by tapping  (Rotate icon) in the navigation bar.

---

### Related Topic

- [Home screen](#)
- [Taking a screenshot](#)
- [Using the Split-screen mode](#)



Smartphone

Xperia PRO-I XQ-BE52/XQ-BE62/XQ-BE72

## Application updates

---

If the automatic update feature is enabled, your applications get updated without you being asked, so you may not realize that large volumes of data are being downloaded. In order to avoid potentially high data transfer costs, you can disable automatic updates or enable automatic updates only over Wi-Fi connection. You have to disable the automatic update feature in the Play Store app to avoid the automatic updating of applications.

- 1 Find and tap  (Play Store icon).
- 2 Tap the account icon, and then find and tap the auto update apps menu in the settings menu.
- 3 Select the preferred option.

---

### Related Topic

- [Setting up a Google account on your device](#)

Smartphone  
Xperia PRO-I XQ-BE52/XQ-BE62/XQ-BE72

## Using location services

---

Location services allow applications such as Maps and the camera to use information from your mobile or Wi-Fi network as well as GPS (Global Positioning System) information to determine your approximate location.

In order to use your device to find out where you are, you need to enable location services.

For more information, go to [support.google.com/](https://support.google.com/).

- 1 Find and tap [Settings] > [Location].
- 2 Tap the switch to enable or disable location services.

### To improve GPS accuracy

The first time you use the GPS function in your device, it can take a few minutes for your location to be found. To help the search, make sure you have a clear view of the sky. Stand still and do not cover the GPS antenna. GPS signals can pass through clouds and plastic, but not through most solid objects such as buildings and mountains. If your location is not found after a few minutes, move to another location.

---

#### Related Topic

- [Overview](#)
- [Settings menu](#)

Smartphone  
Xperia PRO-I XQ-BE52/XQ-BE62/XQ-BE72

## Date and time

---

You can change the date and time on your device.

**1 Find and tap [Settings] > [System] > [Date & time].**

You may find the item under [Advanced].

**2 Tap the desired item to edit and change the values.**

- To set the date or time manually, tap the [Use network-provided time] switch to disable the function.
- To set the time zone manually, tap the [Use network-provided time zone] switch to disable the function.

---

### Related Topic

- [Settings menu](#)
- [Alarm](#)

## BASIC (Basic) mode overview

### Photo mode

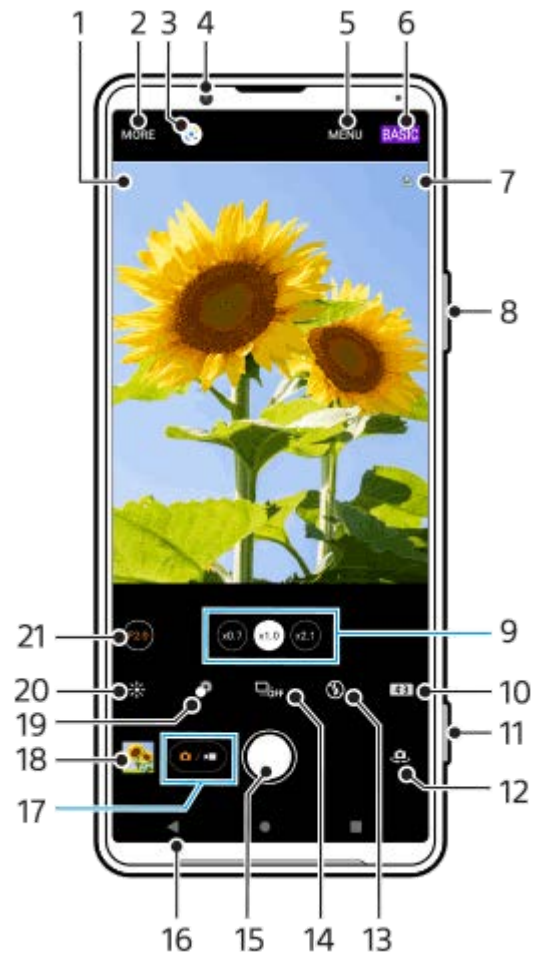

1. Scene recognition icon and conditions icon  
These icons appear when Photo Pro automatically recognizes a scene or condition.
2. Select a capturing mode
3. Google Lens
4. Front camera lens
5. Photo Pro settings menu
6. Switch the shooting mode
7. Geotagging status
8. Use the volume key to zoom in or out
9. Tap one of the angle buttons to switch lenses  
ⓧ (Telephoto button) will be made available through a software update. Software rollouts are a phased process; the timing and availability vary by market and/or operator.
10. Select an aspect ratio
11. Use the camera key to launch Photo Pro or take photos
12. Switch between the front and main camera
13. Select a flash setting. The icon color changes when the flash or flashlight activates.
14. Drive mode button  
Select a self-timer setting or a single shooting or continuous shooting mode.
15. Use the shutter button to take photos
16. Go back or exit Photo Pro

17. Switch between taking photos and videos
18. Tap the thumbnail to view, share, or edit photos
19. Tap to adjust the Bokeh effect
20. Tap to adjust color and brightness
21. Tap to change the aperture value when  $\odot$  (Wide-angle button) is selected.

## ▶ Video mode



1. Selected microphone
2. Select a capturing mode
3. Google Lens
4. Front camera lens
5. Photo Pro settings menu
6. Switch the shooting mode
7. Geotagging status
8. Use the volume key to zoom in or out
9. Tap one of the angle buttons to switch lenses  
 $\odot$  (Telephoto button) will be made available through a software update. Software rollouts are a phased process; the timing and availability vary by market and/or operator.
10. Tap to activate the flashlight. The icon color changes when the flashlight is activated.
11. Use the camera key to launch Photo Pro or record videos
12. Switch between the front and main camera
13. Tap to enable the [Face/Eye AF] function  
 $\odot$  (Face/Eye AF button) will be made available through a software update. Software rollouts are a phased process; the timing and availability vary by market and/or operator.
14. Use the shutter button to record videos
15. Go back or exit Photo Pro
16. Switch between taking photos and videos
17. Tap the thumbnail to view, share, or edit videos
18. Tap to enable HDR (High Dynamic Range)
19. Tap to adjust color and brightness



20. Tap to change the aperture value when  (Wide-angle button) is selected.

---

### Related Topic

- [Selecting a capturing mode](#)
- [Taking a photo or recording a video](#)
- [Geotagging](#)
- [Frequently used features in the BASIC \(Basic\) mode](#)
- [Using the flash](#)
- [Continuous shooting](#)
- [Self-timer](#)
- [Viewing photos and videos](#)
- [Bokeh effect](#)
- [Color and brightness](#)
- [HDR video recording](#)
- [Scanning QR codes](#)
- [Face/Eye AF \(still image/video\)](#)



Smartphone

Xperia PRO-I XQ-BE52/XQ-BE62/XQ-BE72

## Taking a photo or recording a video

This section explains basic camera operations in the BASIC (Basic) mode.

### 1 Launch Photo Pro.

- Press the camera key fully down.
- Touch and hold  (Camera icon) from the lock screen.
- Tap  (Photo Pro icon) from the app drawer.
- Press the power key twice. Find and tap [Settings] > [System] > [Gestures] > [Quickly open camera], and then tap the switch to enable this function.

### 2 Switch the shooting mode to [BASIC] (Basic).

### 3 Tap (Switch between photo and video button) to switch between the photo and video modes.

### 4 Press the camera key or tap the shutter button.

To take a photo when recording a video, tap  (Camera icon).

#### Note





- Note that some functions may not be available depending on the settings.

#### Hint

- Make sure the lenses are clean. A fingerprint or a little dirt can diminish photo quality.
- Use the self-timer when you need extra time to prepare, or to avoid blurred photos.
- Check your device's memory status often. High-resolution photos and videos consume more memory.
- You can scan QR codes.

## Shutter button

The shutter button is used differently depending on the capturing mode and activated features.

-  (Shutter button): Take a photo
-  (Start video recording button): Record a video/Resume recording
-  (Pause video recording button): Pause a video
-  (Stop video recording button): Stop recording a video

#### Hint

- You can prevent Photo Pro from being launched accidentally when the camera key is pressed and held. In the BASIC (Basic) mode, tap [MENU] > [Launch with camera key] > [Off].
- You can set whether to automatically switch to the BASIC (Basic) mode or to the last selected mode when you launch Photo Pro. To change the setting in the BASIC (Basic) mode, tap [MENU] > [Shooting mode at launch] > [Always use Basic mode].

---

---

## Related Topic

- [Settings menu](#)
- [Scanning QR codes](#)
- [Scene and condition recognition](#)
- [Frequently used features in the BASIC \(Basic\) mode](#)
- [Viewing photos and videos](#)
- [Self-timer](#)

F-703-100-11 Copyright 2021 Sony Corporation

Smartphone  
Xperia PRO-I XQ-BE52/XQ-BE62/XQ-BE72

## Viewing photos and videos

View or share photos and videos in the Google Photos app after taking photos or recording videos.

### Viewing photos and videos while using Photo Pro



You can also edit photos or videos, such as by adjusting the colors or cropping photos.

1. While using Photo Pro, tap the thumbnail **(A)** to open a photo or video.



2. Swipe left or right to view your photos and videos.

#### Hint

- Tap  (Share icon) to share a photo or a video, or  (Edit icon) to edit it. To hide or show icons, tap the screen.

### Viewing previously taken photos or recorded videos

1. Launch the Google Photos app.

#### Hint

- For more information about the Google Photos app, go to [support.google.com/photos](https://support.google.com/photos).

#### Related Topic

- [Taking a photo or recording a video](#)



Smartphone  
Xperia PRO-I XQ-BE52/XQ-BE62/XQ-BE72

## Scanning QR codes

---

You can scan QR codes using Photo Pro.

- 1 Find and tap  (Photo Pro icon), and then switch the shooting mode to [BASIC] (Basic).
- 2 Point the camera at the QR code, and then tap the notification that appears.  
If the notification does not appear, drag down the status bar to open the notification panel, and then confirm it.

### To turn the [QR Code reader] function on

1. Find and tap  (Photo Pro icon), and then switch the shooting mode to [BASIC] (Basic).
2. Tap [MENU].
3. Tap [QR Code reader] > [On].
4. Close the menu.  
The setting is saved.

#### Hint

- To display the QR code notification on the Photo Pro app screen, find and tap [Settings] > [Apps & notifications] > [Photography Pro] > [Notifications] > [QR Code reader], and then tap the [Pop on screen] switch to enable the function with [Default] selected.

---

### Related Topic

- [Taking a photo or recording a video](#)
- [Settings menu](#)

Smartphone  
Xperia PRO-I XQ-BE52/XQ-BE62/XQ-BE72

## Frequently used features in the BASIC (Basic) mode

### Changing the aspect ratio

1. In the BASIC (Basic) mode, tap **4:3** (Aspect ratio icon).
2. Select a setting.

#### Hint

- The number of photos and videos you can store depends on the resolution or MP (megapixel) value used and video length. High-resolution photos and videos take up more memory, so keep in mind that a lower resolution can be suitable for everyday use.

### Adjusting the camera settings

1. In the BASIC (Basic) mode, tap [MENU].
2. Swipe the list to view the available settings and select a setting.

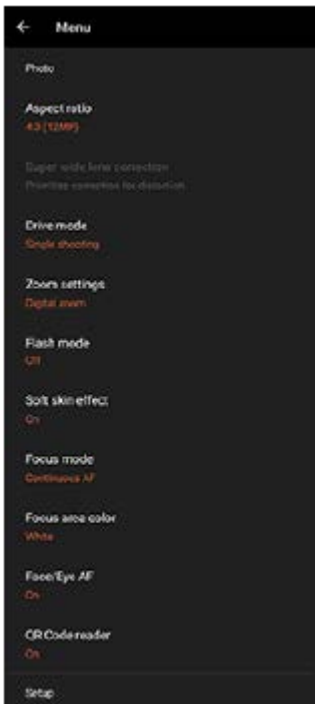

#### Note

- Available settings differ between the photo and video modes.

#### Hint



- Tap [Introduction to features] to check information on various functions.
- Tap [Tips] to go to the Photo Pro tips website.

### Switching between the main and front camera

1. In the BASIC (Basic) mode, tap  (Switch camera icon) to switch between the main and front camera.

## Switching lenses and zooming

You can switch lenses while using the main camera.

1. While using the main camera in the BASIC (Basic) mode, tap one of the angle buttons.
  -  (Telephoto button)
  -  (Wide-angle button)
  -  (Super-wide-angle button)
2. Zoom in on the image.
  - Tap one of the angle buttons to select a lens, and then drag the angle button to the left and right (in the portrait orientation) or up and down (in the landscape orientation).
  - Pinch in or out on the camera screen.
  - Use the volume key.

### Hint

-  (Telephoto button) will be made available through a software update. Software rollouts are a phased process; the timing and availability vary by market and/or operator.
- To zoom using digital processing that preserves more of the original image quality, tap [MENU] > [Zoom settings] > [AI super resolution zoom].
- The lens aperture value can be changed when  (Wide-angle button) is selected by tapping [F2.0] or [F4.0].

## Reducing wind noise when recording

1. In the BASIC (Basic) mode, tap  (Switch between photo and video button) to select a video mode.
2. Tap [MENU] > [Intelligent wind filter].
3. Tap the switch to enable the function.

## Switching microphones when recording

1. In the BASIC (Basic) mode, tap  (Switch between photo and video button) to select a video mode.
2. Tap [MENU] > [Mic], and then select [LR mic (stereo)] or [Rear mic (mono)].  
When [Rear mic (mono)] is selected, touch the rear panel as little as possible during recording to avoid noise being recorded.

### Related Topic

- [Taking a photo or recording a video](#)
- [Scanning QR codes](#)
- [Overview](#)
- [Pairing with a Bluetooth remote commander](#)





Smartphone

Xperia PRO-I XQ-BE52/XQ-BE62/XQ-BE72

## Taking a selfie

---

Switch to the front camera and take a photo of yourself. To avoid blurred photos in low-light conditions, place your device on a solid surface and use the self-timer to keep the device steady.

- 1 In the **BASIC (Basic) mode**, tap  (Switch between photo and video button) to select a photo or video mode.
- 2 Tap  (Switch camera icon) to activate the front camera.
- 3 Tap  (Self-timer icon) to select the delay time if you want to use the self-timer.
- 4 Press the camera key or tap the shutter button to take a selfie.

Smartphone  
Xperia PRO-I XQ-BE52/XQ-BE62/XQ-BE72

## Taking a selfie using Hand shutter

Use Hand shutter to automatically take a photo a certain period of time after the camera detects your hand. The Hand Shutter feature is available only when using the front camera.

- 1 In the BASIC (Basic) mode, tap  (Switch camera icon) to activate the front camera.**
- 2 Tap [MENU].**
- 3 Tap [Hand Shutter] > [On].**
- 4 Close the menu.**

The setting is saved.
- 5 Turn your palm with your fingers straight up towards the camera.**

After the camera detects your hand and a certain period of time has elapsed, a selfie is taken.

### Hint

- When the self-timer is set, the timer starts after the camera detects your hand.

Smartphone  
Xperia PRO-I XQ-BE52/XQ-BE62/XQ-BE72

## Color and brightness

Your camera automatically adjusts the color and brightness value by detecting the light conditions and estimating the color temperature of ambient light. Digital cameras can only estimate the color temperature, so you may need to adjust the settings to get it correct.

If you experience yellow-colored photos in indoor environments or bluish photos when using the flash, try adjusting the color.

- 1 In the BASIC (Basic) mode, tap  (Color and brightness icon).**
- 2 Drag the sliders to adjust the color and brightness.**

The icon color changes when the settings are adjusted.  
To hide the sliders, tap  (Close button) or the viewfinder.  
To reset the settings, tap [Reset].
- 3 Press the camera key or tap the shutter button to take a photo or record a video.**



### Hint

- Look for light with direction and color that gives a scene shape and depth. This type of light occurs just before sunrise and at sunset. Natural light from a window is also good.

Smartphone  
Xperia PRO-I XQ-BE52/XQ-BE62/XQ-BE72

## Bokeh effect

You can take pictures with the Bokeh effect when using the main camera on your device. The Bokeh effect decreases focus in the background of a photo to emphasize objects at the foreground, for an artistic effect.

- 1 While using the main camera in the BASIC (Basic) mode, tap  (Bokeh icon).**
- 2 Tap the [Bokeh] button beside the slider to turn the bokeh effect on.**  
The [Bokeh] button turns orange.
- 3 Drag the slider to adjust.**  
To hide the sliders, tap  (Close button) or the viewfinder.  
To switch the Bokeh effect on or off, tap the [Bokeh] button beside the slider.
- 4 Press the camera key or tap the shutter button to take a photo.**

### Note

- The Bokeh effect is not available when the x0.7 lens is selected.
- Zooming is not available while using the Bokeh effect.

### Hint

- If you get too close to or too far to an object while using the Bokeh effect, a warning message appears. If this happens, adjust the distance between your camera and the object to take the photo with Bokeh effect.



Smartphone

Xperia PRO-I XQ-BE52/XQ-BE62/XQ-BE72

## HDR video recording

---

Enable HDR (High Dynamic Range) to make your videos appear more dramatic and closer to what you see in real life.

- 1 In the **BASIC (Basic)** mode, tap  (Switch between photo and video button) to select a video mode.
- 2 Tap  (HDR icon) and select [HDR].

### Note

- This setting is not available when [Video size] is set to [Full HD (60 fps)] or [HD].

Smartphone

Xperia PRO-I XQ-BE52/XQ-BE62/XQ-BE72

## Recording a steady video

---

When recording videos, you can use Video stabilization to compensate for camera movements and steady the frame.

- 1** In the BASIC (Basic) mode, tap  (Switch between photo and video button) to select a video mode.
- 2** Tap [MENU].
- 3** Tap [Video stabilization] > [On].
- 4** Close the menu.  
The setting is saved.
- 5** Press the camera key or tap the shutter button to record a video.

Smartphone  
Xperia PRO-I XQ-BE52/XQ-BE62/XQ-BE72

## Selecting a capturing mode





---

You can select a capturing mode according to the subject or your purpose.

- 1 In the **BASIC (Basic) mode**, tap **[More]**, and then select a capturing mode.

### Capturing modes overview

The following are some of the main capturing modes.

-  (Slow motion icon): Add a slow-motion effect after recording a video
-  (Portrait selfie icon): Take better-looking selfies
-  (Panorama icon): Take wide-angle and panoramic photos
-  (Creative effect icon): Take photos with effects and color filters

#### Note

- Available settings depend on the capturing mode selected.

---

### Related Topic

- [Slow motion videos](#)
- [Portrait selfie](#)
- [Panorama](#)
- [Creative effect](#)

Smartphone  
Xperia PRO-I XQ-BE52/XQ-BE62/XQ-BE72



## Slow motion videos

The Slow motion video mode adds powerful effects to your videos. The Slow motion effect is added after a video is recorded at normal speed.

### Note

- Good lighting conditions are essential when you record slow motion videos.

### Adding slow motion effect after recording a video

1. In the BASIC (Basic) mode, tap [More] >  (Slow motion icon).
2. Press the camera key or tap the shutter button to record a video.
3. Tap  (Stop video recording button) to stop recording.
4. Tap the thumbnail to open the video.
5. Drag the handles on the slow motion timeline to the positions where you want the slow motion effect to appear.  
(A): Handles  
(B): Slow motion timeline  
(C): Tap to turn the sound on or off.

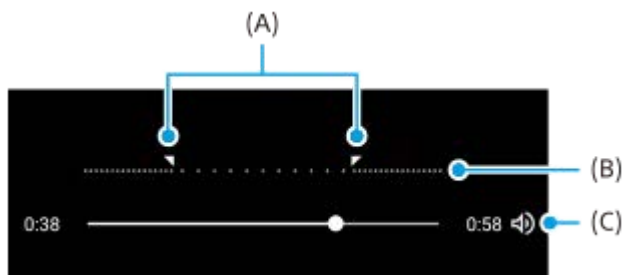



Smartphone

Xperia PRO-I XQ-BE52/XQ-BE62/XQ-BE72





## Portrait selfie

---



Portrait selfie allows you to take better-looking selfies.

- 1** In the **BASIC (Basic)** mode, tap **[More]** >  (**Portrait selfie icon**).
- 2** Tap the icon for the effect you want to apply, and drag the slider to adjust the effect.  
If desired, adjust the other effects in the same way.
- 3** Press the camera key or tap the shutter button to take a photo.

### Portrait selfie overview

-  (Bokeh icon): Applies a blurring effect around a person
-  (Soft skin icon): Softens skin tones
-  (Skin brightness icon): Brightens skin tones
-  (Eye enlargement icon): Enlarges eyes
-  (Slender face icon): Makes your face look slimmer

#### Hint

- You can save your portrait in the same direction as the preview by tapping  (Mirror icon) > [On].
- You can take a photo by tapping anywhere on the screen. Tap  (Touch capture icon) > [On].

Smartphone

Xperia PRO-I XQ-BE52/XQ-BE62/XQ-BE72

## Panorama

---

Use the Panorama app to take wide-angle and panoramic photos.

- 1 In the **BASIC (Basic)** mode, tap **[More]** >  (**Panorama icon**).
- 2 Press the camera key or tap the shutter button.
- 3 Move the camera slowly and steadily in the direction of movement indicated on the screen.



Smartphone

Xperia PRO-I XQ-BE52/XQ-BE62/XQ-BE72

## Creative effect

---

With the Creative effect app you can preset effects and color filters before taking a photo or recording a video.

- 1 In the BASIC (Basic) mode, tap [More] >  (Creative effect icon).
- 2 Swipe to browse filters, or tap a filter to preview the effect.
- 3 Tap  (Apply creative effect icon) to apply the filter and return to the camera screen.
- 4 Press the camera key or tap the shutter button to take a photo or record a video.

### Hint

- Tap  (Switch filter icon) to switch filters.

Smartphone  
Xperia PRO-I XQ-BE52/XQ-BE62/XQ-BE72

## AUTO/P/S/M mode overview

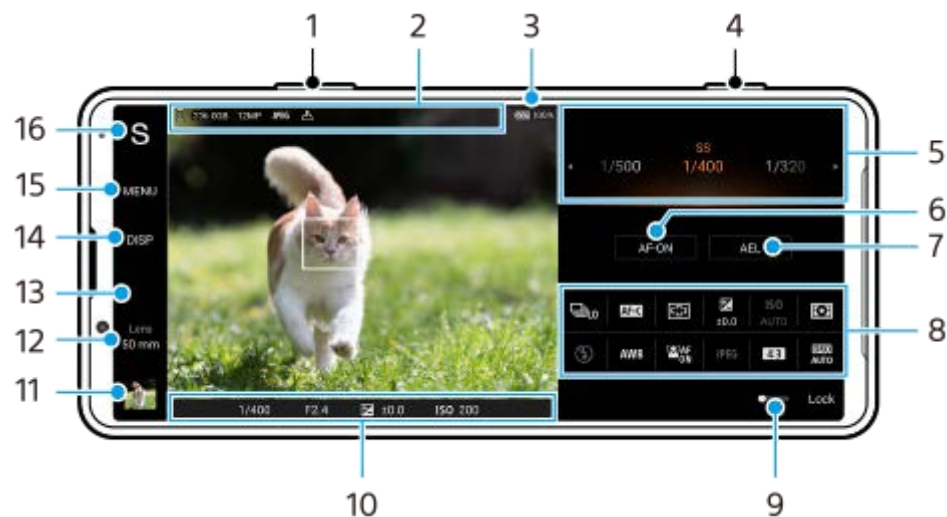

1. Use the volume key to zoom in or out.
2. Data storage icon/Amount of free space/Image size/File format/Geotagging status  
The scene icon or condition icon is also displayed when the AUTO mode is selected.
3. Battery status
4. Use the camera key to launch Photo Pro or shoot images.
5. Dial
  - Adjust the exposure value when the Program auto (P) mode is selected.
  - Adjust the shutter speed when the Shutter speed priority (S) mode or Manual exposure (M) mode is selected.
6. Tap to lock the focus.  
The button turns orange when the focus is locked. Tap the button again to unlock the focus.
7. Tap to lock the exposure.  
The button turns orange when the exposure is locked. Tap the button again to unlock the exposure.  
To assign another function to the AEL button, tap [MENU] > [Setup] > [AEL button customization].
8. Function menu  
Tap to adjust settings.  
To re-assign or re-order the setting items in the function menu, tap [MENU] > [Setup] > [Function menu customization].
9. Drag the switch to the right to lock the items on the left side of the viewfinder and the function menu, preventing accidental operations.
10. Focus indicator/exposure settings
  - (Auto focus icon) indicates that the subject is in focus.
  - ✳ (AE lock icon) indicates that the exposure is locked.
11. Tap the thumbnail to view, share, or edit photos.  
Tap ◀ (Back button) to return to the Photo Pro standby screen.

12. Tap to switch lenses.

To use the zoom, tap  (Open zoom dial icon), pinch in or out on the viewfinder, or use the volume key. [50 mm] will be made available through a software update. Software rollouts are a phased process; the timing and availability vary by market and/or operator.

13. Tap to change the aperture value when [Lens] is set to [24 mm].

14. Tap to show or hide information displayed on the viewfinder.

The histogram represents the luminance distribution graphically.

The level meter helps you to measure the angle of the device and keep the picture horizontal. When your device senses that it is level, the level meter turns green.

To customize the items that are displayed when you tap [DISP], tap [MENU] > [Setup] > [DISP button customization].

15. Tap to adjust more detailed settings.

16. Tap to switch the shooting mode.

To select the default shooting mode when Photo Pro is launched, tap [MENU] > [Setup] > [Shooting mode at launch], and then select an option.

---

### Related Topic

- [Function menu](#)
- [Shooting still images](#)
- [Auto mode \(AUTO\)](#)
- [Program auto \(P\)](#)
- [Shutter speed priority \(S\)](#)
- [Manual exposure \(M\)](#)
- [Camera settings memory](#)
- [Memory recall \(MR\)](#)
- [Pairing with a Bluetooth remote commander](#)

## Function menu

The settings that can be adjusted depend on the shooting mode.



### 1. Drive mode

#### Single shooting

**Continuous shooting: Hi:** Shoots images continuously while you press and hold down the camera key. The speed reaches a maximum of 20 images per second.

**Continuous shooting: Lo:** Shoots images continuously while you press and hold down the camera key. The speed reaches a maximum of 10 images per second.

**Self-timer: 3 sec / Self-timer: 10 sec**

### 2. Focus mode

**Single-shot AF:** When you press the camera key halfway down and the camera focuses on a subject, the focus remains locked until you stop pressing the camera key halfway down. Use [Single-shot AF] when the subject is motionless.

**Continuous AF:** The camera continues to focus while the camera key is pressed and held halfway down. Use [Continuous AF] when the subject is in motion.

**Manual Focus:** Adjusts the focus manually using the slider that is displayed below the function menu. If you cannot focus on the intended subject using auto focus, use manual focus.

### 3. Focus area

**Wide:** Automatically focuses on the whole range of the screen.

**Center:** Automatically focuses on a subject in the center of the image.

### 4. Exposure value

Adjusts the exposure value in the Shutter speed priority (S) mode and Manual exposure (M) mode using the dial.

### 5. ISO sensitivity

Sets the ISO sensitivity automatically (AUTO) or manually. Sensitivity to light is expressed by the ISO number (recommended exposure index) using the dial. The larger the number, the higher the sensitivity.

### 6. Metering mode

**Multi:** Measures light on each area after dividing the total area into multiple areas and determines the proper exposure of the entire screen (Multi-pattern metering).

**Center:** Measures the average brightness of the entire screen, while emphasizing the central area of the screen (Center-weighted metering).

**Spot:** Measures only inside the metering circle.

### 7. Flash mode

Auto / Fill flash / Red-eye reduction / Off / Flashlight

## 8. White balance

Auto / Cloudy / Daylight / Fluorescent / Incandescent / Shade: Adjusts the color tones according to the selected light source that is illuminating the subject (preset white balance). To finely adjust the color tones, tap [Adjust] to display the fine adjustment screen, and then move the orange dot to the desired position. After adjusting, tap **X** (Close button).

**Custom 1 / Custom 2 / Custom 3:** Memorizes the basic white color under the light conditions for the shooting environment. To adjust the basic white color, select one of the items, tap [Set], and then follow the on-screen instructions.

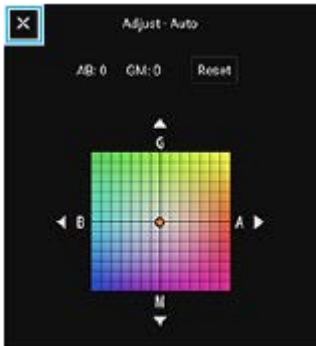

## 9. Face/Eye AF

On / Off

The camera detects the faces or eyes of people and animals and focuses on them automatically.

## 10. File format

**RAW:** Digital processing is not performed on this file format. Select this format to process images on a computer for professional purposes.

**RAW & JPEG:** A RAW image and a JPEG image are created at the same time. This is suitable when you need two image files, a JPEG for viewing, and a RAW for editing.

**JPEG:** The image is recorded in the JPEG format.

## 11. Aspect ratio (Image size)

The image size is displayed according to the aspect ratio.

4:3 / 16:9 / 1:1 / 3:2

## 12. D-Range Optimizer (DRO) / Auto HDR

**D-Range Optimizer:** Optimizes brightness and gradation by analyzing the contrast between the subject and the background from a single image.

**Auto HDR:** Optimizes brightness and gradation by overlaying multiple images shot using different exposures.

## To re-assign or re-order setting items in the function menu

1. Tap [MENU] > [Setup] > [Function menu customization].
2. Follow the on-screen instructions.

---

## Related Topic

- [AUTO/P/S/M mode overview](#)
- [Shooting still images](#)
- [Program auto \(P\)](#)
- [Shutter speed priority \(S\)](#)
- [Manual exposure \(M\)](#)
- [Continuous shooting](#)
- [Self-timer](#)
- [Setting the focus by touching the viewfinder](#)
- [Using the flash](#)



- [Face/Eye AF \(still image/video\)](#)

F-703-100-11 Copyright 2021 Sony Corporation



## Shooting still images

### 1 Launch Photo Pro.

- Find and tap  (Photo Pro icon).
- Press the camera key fully down.
- Touch and hold  (Camera icon) from the lock screen.
- Press the power key twice. Find and tap [Settings] > [System] > [Gestures] > [Quickly open camera], and then tap the switch to enable the function.

### 2 Select a shooting mode.

- AUTO (Auto mode): Settings values are determined appropriately by Photo Pro so that you can take photos of any subject under any conditions with good results.
- P (Program auto): You can take photos with an automatically adjusted exposure (both the shutter speed and the aperture value).
- S (Shutter speed priority): You can take photos of fast-moving subjects, etc. with a manually adjusted shutter speed. (The ISO value is adjusted automatically.)
- M (Manual exposure): You can take photos with the desired shutter speed and ISO value.
- MR (Memory recall): You can register often-used modes or settings in advance and recall them when taking photos. Select [MR], and then tap [Set] to apply the settings displayed under [Recall camera settings].

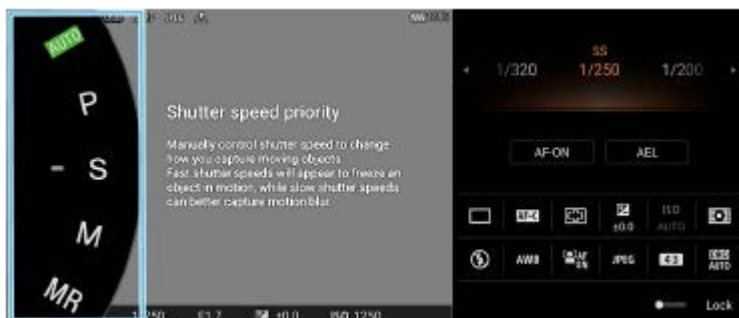

### 3 Adjust the settings.

### 4 Press the camera key halfway down to focus.

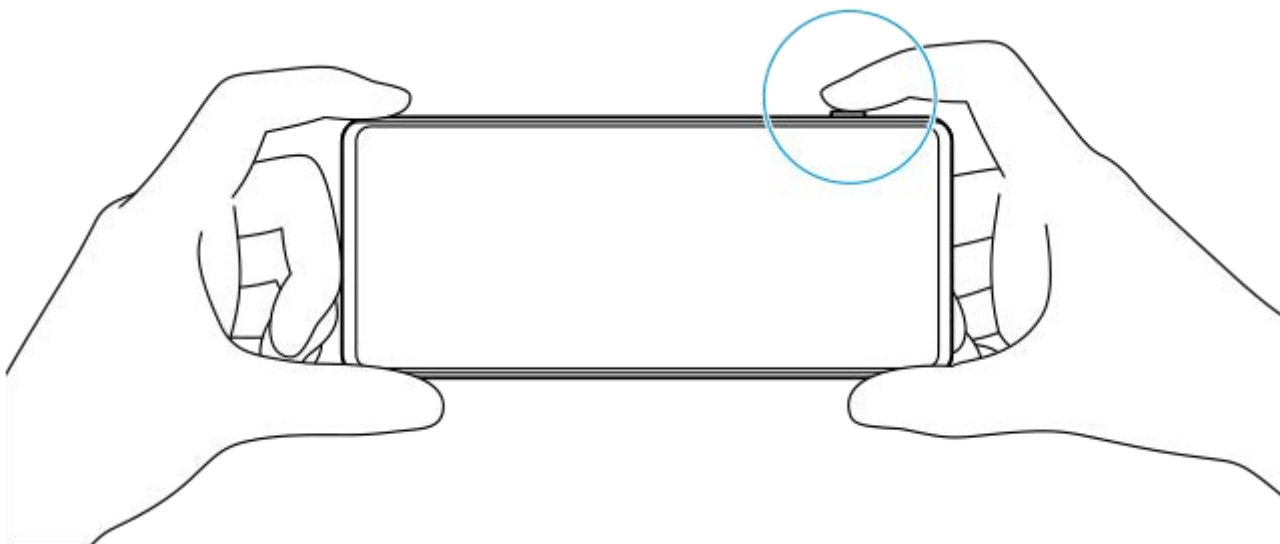

5

Press the camera key fully down.

**Note**

- There is no shutter button on the Photo Pro standby screen when the shooting mode is set to the AUTO/P/S/M modes. Use the camera key on your device.

---

**Related Topic**

- [Taking a photo or recording a video](#)
- [Auto mode \(AUTO\)](#)
- [Program auto \(P\)](#)
- [Shutter speed priority \(S\)](#)
- [Manual exposure \(M\)](#)
- [Camera settings memory](#)
- [Memory recall \(MR\)](#)

Smartphone

Xperia PRO-I XQ-BE52/XQ-BE62/XQ-BE72

## Auto mode (AUTO)

---

The camera detects the type of scene and conditions and then shoots images with automatically adjusted settings, reducing noise and preventing camera shake.

**1** Switch the shooting mode to [AUTO] (Auto mode).

**2** Point the camera at the subject.

When the camera recognized the scene, the icon for the recognized scene appears on the screen.

**3** Press the camera key halfway down to focus.

**4** Press the camera key fully down.

---

### Related Topic

- [AUTO/P/S/M mode overview](#)
- [Function menu](#)
- [Camera settings memory](#)

Smartphone  
Xperia PRO-I XQ-BE52/XQ-BE62/XQ-BE72

## Program auto (P)

The camera automatically adjusts the exposure (both the shutter speed and the aperture value) and you can set other shooting functions as desired.

- 1 Switch the shooting mode to [P] (Program auto).
- 2 Set the shooting functions to your desired settings.
- 3 Adjust the exposure value (EV) using the dial.



- 4 Press the camera key halfway down to focus.
- 5 Press the camera key fully down.

### Related Topic

- [AUTO/P/S/M mode overview](#)
- [Function menu](#)
- [Camera settings memory](#)

Smartphone  
Xperia PRO-I XQ-BE52/XQ-BE62/XQ-BE72

## Shutter speed priority (S)

You can capture a moving subject in various ways by adjusting the shutter speed. For example, you can capture it at the instant of movement with a high speed shutter, or as a trailing image with a low speed shutter.

- 1 Switch the shooting mode to [S] (Shutter speed priority).
- 2 Set the shooting functions to your desired settings.
- 3 Select the desired shutter speed using the dial.



- 4 Press the camera key halfway down to focus.
- 5 Press the camera key fully down.

### Hint

- Use a tripod to prevent camera-shake when you have selected a slow shutter speed.
- When you shoot indoor sports scenes, set the ISO sensitivity to a higher value.

### Related Topic

- [AUTO/P/S/M mode overview](#)
- [Function menu](#)
- [Camera settings memory](#)

Smartphone  
Xperia PRO-I XQ-BE52/XQ-BE62/XQ-BE72

## Manual exposure (M)

You can shoot with the desired exposure setting by adjusting both the shutter speed and ISO sensitivity. You can also shoot a trailing image of the movement of a subject with a long exposure.

- 1 Switch the shooting mode to [M] (Manual exposure).
- 2 Set the shooting functions to your desired settings.
- 3 Select the desired shutter speed and ISO sensitivity.



- 4 Press the camera key halfway down to focus.
- 5 Press the camera key fully down.

### Related Topic

- [AUTO/P/S/M mode overview](#)
- [Function menu](#)
- [Camera settings memory](#)

Smartphone  
Xperia PRO-I XQ-BE52/XQ-BE62/XQ-BE72

## Camera settings memory

---

Allows you to register often-used combinations of modes and settings. The registered settings can be recalled by switching the shooting mode to [MR] (Memory recall).

- 1 In the **AUTO/P/S/M** mode, adjust the settings.
- 2 Tap **[MENU] > [Shooting] > [Camera settings memory]**.
- 3 Confirm the settings, and then tap **[Save]**.

To change the settings, tap **[Cancel]**, and then repeat the procedure starting from Step 1.

### Hint

- To change the registered settings, repeat the procedure starting from Step 1.

---

### Related Topic

- [Auto mode \(AUTO\)](#)
- [Program auto \(P\)](#)
- [Shutter speed priority \(S\)](#)
- [Manual exposure \(M\)](#)
- [Memory recall \(MR\)](#)

Smartphone

Xperia PRO-I XQ-BE52/XQ-BE62/XQ-BE72

## Memory recall (MR)

---

Allows you to shoot an image with recalled shooting settings. You can register often-used combinations of modes and settings with [Camera settings memory].

- 1 Switch the shooting mode to [MR] (Memory recall).
  - 2 Select [Set] to apply the recalled settings.
  - 3 Press the camera key halfway down to focus.
  - 4 Press the camera key fully down.
- 

### Related Topic

- [Camera settings memory](#)



Smartphone  
Xperia PRO-I XQ-BE52/XQ-BE62/XQ-BE72

## Continuous shooting

You can shoot still images continuously and find the best shot.

### Note

- In the BASIC (Basic) mode, the [Continuous shooting] and [Focus mode] functions are available while using the main camera in a photo mode.

### Turning the [Continuous shooting] function on or off

1. Tap the Drive mode button, and then select an option.  
BASIC (Basic) mode



- [Continuous shooting: Hi]: Shoots images continuously at a high speed.
  - [Continuous shooting: Lo]: Shoots images continuously at a low speed.
  - [Single shooting]: Shoots a single image.
2. Tap **X** (Close button) to close the menu.  
You can also close the menu by tapping the viewfinder.

### To select the focus method according to the movement of the subject

1. Tap [MENU].
2. Find and tap [Focus mode], and then select an option.
  - [Single-shot AF]: The camera locks the focus once focusing is complete. Use [Single-shot AF] when the subject is motionless.
  - [Continuous AF]: The camera continues to focus while the camera key is pressed (or while the shutter button is touched and held in the BASIC (Basic) mode). Use [Continuous AF] when the subject is in motion.
3. Close the menu.  
The setting is saved.

### Shooting images continuously

1. Touch and hold the shutter button in the BASIC (Basic) mode or long press the camera key.  
The number of pictures taken is indicated in the viewfinder.
2. Release the shutter button or camera key.  
All photos are saved.

## To select the best shot

1. Tap the thumbnail to view the results.
2. Scroll through the images you shot and select the image that you want to save.
3. Tap  (Burst icon), and then select an option.

---

---

### Related Topic

- [Self-timer](#)

F-703-100-11 Copyright 2021 Sony Corporation

## Self-timer

Use the Self-timer to get more time to prepare for shooting an image. It also helps to keep your device steady and avoid blurred images.

- 1 Tap the Drive mode button, and then select [Self-timer: 10 sec] or [Self-timer: 3 sec] as the delay time.

BASIC (Basic) mode

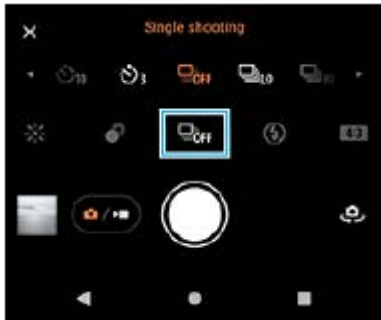

- 2 Tap **X** (Close button) to close the menu.

You can also close the menu by tapping the viewfinder.

- 3 Press the camera key (or tap the shutter button in the BASIC (Basic) mode).

A series of beeps marks the countdown until the image is shot.

### Hint

- To cancel the Self-timer, tap the Drive mode button, and then select [Single shooting].

### Related Topic

- [Continuous shooting](#)

Smartphone  
Xperia PRO-I XQ-BE52/XQ-BE62/XQ-BE72

## Using the flash

---

Use the flash according to the subject and lighting conditions.

- 1 Tap the flash icon, such as  (Auto flash icon).
- 2 If required, change the flash setting.

### Note

- In the BASIC (Basic) mode, available settings depend on the capturing mode, photo mode, and video mode.

### Hint

- When the background is brighter than the object, use Fill flash to remove unwanted dark shadows.
- Even if light conditions are poor, try to take photos with and without the flash. Sometimes the quality is better without the flash.













Smartphone  
Xperia PRO-I XQ-BE52/XQ-BE62/XQ-BE72

## Scene and condition recognition

In the BASIC (Basic) mode and AUTO (Auto) mode, the camera detects the type of scene and conditions, such as food, a portrait, a night scene, etc., and shoots still images with automatically adjusted settings.



### Scene recognition

When the camera recognizes certain scenes, the following icons and guides are displayed.

Icon	Guide
	Gourmet
	Macro
	Soft snap
	Infant
	Backlight portrait
	Backlight
	Night portrait
	Night scene
	Low light
	Landscape
	Spotlight
	Document

### Condition recognition

When the camera recognizes conditions, the following icons are displayed.

Icon	Condition
	Motion
	Walking
	Tripod

### Related Topic

- [BASIC \(Basic\) mode overview](#)
- [AUTO/P/S/M mode overview](#)
- [Taking a photo or recording a video](#)



Smartphone  
Xperia PRO-I XQ-BE52/XQ-BE62/XQ-BE72

## Setting the focus by touching the viewfinder

You can select a subject on which to focus by touching it in the viewfinder. After specifying the position where you want to focus, press the camera key halfway down to focus, and then shoot a still image.

There are several options that the camera adjusts automatically when you touch the viewfinder.

### Note

- In the BASIC (Basic) mode, the [Touch to adjust] function is available while using the main camera in a photo mode.

- 1 Tap [MENU].
- 2 Find and tap [Touch to adjust], and then select [Autofocus] or [Focus and brightness].
  - Autofocus: Focuses automatically on the specified position.
  - Focus and brightness: Automatically focuses on the specified position and adjusts the brightness.
- 3 Close the menu.

The setting is saved.
- 4 Touch the subject to focus in the viewfinder.

To cancel focusing, tap  (Cancel focusing button).
- 5 Press the camera key halfway down to focus.
- 6 Press the camera key fully down (or tap the shutter button in the BASIC (Basic) mode).

### Hint

- When [Touch to adjust] is set to [Autofocus] or [Focus and brightness], you can change the color of the focus frame. Tap [MENU], find and tap [Focus area color], and then select an option.

### Related Topic

- [Continuous shooting](#)

Smartphone  
Xperia PRO-I XQ-BE52/XQ-BE62/XQ-BE72

## Face/Eye AF (still image/video)

The camera can detect the faces or eyes of people and animals, and then focus on the eyes automatically (Eye AF). To change the focus target, tap the face of the subject on whom you would like to focus.

### Note

- In the BASIC (Basic) mode, the [Face/Eye AF] function in a video mode will be made available through a software update. Software rollouts are a phased process; the timing and availability vary by market and/or operator.
- In the BASIC (Basic) mode, the [Face/Eye AF] function is available while using the main camera.

## Turning the [Face/Eye AF] function on

1. Tap [MENU].
2. Find and tap [Face/Eye AF] > [On].
3. Close the menu.  
The setting is saved.

### Hint

- When a video mode is selected in the BASIC (Basic) mode, you can turn the [Face/Eye AF] function on or off by tapping  (Face/Eye AF button) even during recording.

## Shooting an image using the [Face/Eye AF] function

1. Point the camera at the subject.  
When the camera detects the faces of people or animals, a detection frame appears.
2. Tap the face on which you want to focus.
3. Press the camera key halfway down to focus.  
The camera focuses on one of the eyes with a green frame.
4. Press the camera key fully down (or tap the shutter button in the BASIC (Basic) mode).



Smartphone  
Xperia PRO-I XQ-BE52/XQ-BE62/XQ-BE72

## Softening the skin tone

---

You can shoot images with softer skin tones.

- 1 Tap [MENU].**
- 2 Find and tap [Soft skin effect] > [On].**
- 3 Close the menu.**  
The setting is saved.

Smartphone  
Xperia PRO-I XQ-BE52/XQ-BE62/XQ-BE72

## Tracking an object

---

The camera can detect and track a moving object.

### Note

- In the BASIC (Basic) mode, the [Touch to adjust] function is available while using the main camera in a photo mode.

### Turning the [Object tracking] function on

1. Tap [MENU].
2. Find and tap [Touch to adjust] > [Object tracking].
3. Close the menu.  
The setting is saved.

### Shooting an image using the [Object tracking] function

1. Select an object to track by touching it in the viewfinder.  
To cancel tracking, tap  (Cancel tracking button).
2. Press the camera key (or tap the shutter button in the BASIC (Basic) mode).

Smartphone  
Xperia PRO-I XQ-BE52/XQ-BE62/XQ-BE72

## Setting the Transfer & Tagging add-on mode

By using the Transfer & Tagging add-on app, you can add IPTC metadata to images shot by your device, insert captions for them, and more. For more information about the Transfer & Tagging add-on app, go to <https://support.d-imaging.sony.co.jp/app/transfer/>.

- 1 Tap [MENU].
- 2 Find and tap [Transfer & Tagging add-on mode] > [On].
- 3 Close the menu.  
The setting is saved.

### Note

- In the BASIC (Basic) mode, you cannot shoot images continuously or shoot images with a Bokeh effect when the Transfer & Tagging add-on mode is turned on.
- Set your device to link to a camera or computer using the Transfer & Tagging add-on app to turn on the Transfer & Tagging add-on mode.

Smartphone  
Xperia PRO-I XQ-BE52/XQ-BE62/XQ-BE72

## Data storage

---

You can select whether to store still images and videos on your device's internal storage or on an SD card.

- 1 Tap [MENU].**
- 2 Find and tap [Data storage], and then select an option.**
- 3 Close the menu.**  
The setting is saved.

Smartphone  
Xperia PRO-I XQ-BE52/XQ-BE62/XQ-BE72



## Geotagging

---

You can save your still images and videos with the location where they were shot, this is called geotagging. The option to geotag your still images and videos requires a wireless network and that the GPS function be enabled.

- 1 Tap [MENU].
- 2 Find and tap [Save location] > [On].
- 3 Close the menu.  
The setting is saved.

### Geotagging status icons

-  (Acquired GPS icon): The geographical position is saved.
-  (GPS not found icon): The geographical position is not found.

Smartphone  
Xperia PRO-I XQ-BE52/XQ-BE62/XQ-BE72

## Grid lines

---

With Grid lines, you can apply the “Rule of Thirds” and place important objects along the grid lines or their intersections. By not always having the object in the middle of the frame, you can make your still images and videos more interesting.

- 1 Tap [MENU].**
- 2 Find and tap [Grid lines] > [On].**
- 3 Close the menu.**  
The setting is saved.

Smartphone

Xperia PRO-I XQ-BE52/XQ-BE62/XQ-BE72

## Different ways to use the volume key

---

You can change the way you use the volume key.

- 1 Tap **[MENU]**.
- 2 Find and tap **[Use Volume key as]**, and then select an option.
- 3 Close the menu.  
The setting is saved.

### Volume key settings

- **Zoom:** Use the volume key to zoom in or out.
- **Volume:** The volume key is deactivated for the camera.
- **Shutter:** Use the volume key as a shutter button for still images and videos.

Smartphone  
Xperia PRO-I XQ-BE52/XQ-BE62/XQ-BE72

## Audio signals

---

You can select whether or not the camera produces sounds, such as a shutter sound, sounds at the start and end of video recording, and a series of beeps for the countdown when you use the self-timer.

- 1 Tap [MENU].**
- 2 Find and tap [Audio signals], and then select an option.**
- 3 Close the menu.**  
The setting is saved.



Smartphone

Xperia PRO-I XQ-BE52/XQ-BE62/XQ-BE72

## Transferring music from a computer to your device

---

There are two ways to transfer music from a computer to your device:

- Connect your device to a computer using a USB cable. Select [File Transfer] on your device and then copy and paste or drag and drop the files using the computer.
- On the computer, save your media files using Google Drive. Then, synchronize the data on your device by logging in to the Google account.

### Note

- The Music app may not support all music file formats.

---

### Related Topic

- [Connecting your device to USB accessories](#)
- [Setting up a Google account on your device](#)
- [Listening to music](#)
- [Music app features](#)

Smartphone

Xperia PRO-I XQ-BE52/XQ-BE62/XQ-BE72

## Listening to music

Use the Music app to listen to your favorite music.

### Music player overview

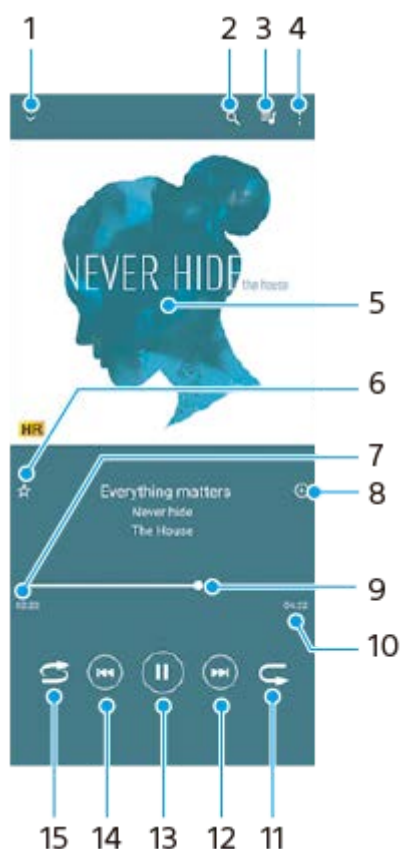

1. Minimize the full screen player
2. Search all songs saved to your device
3. View the play queue
4. View more options
5. Album art (if available)
6. Add or remove a song as a favorite
7. Elapsed time of current song
8. Add a song to a playlist
9. Progress indicator – drag or tap along the line to fast-forward or rewind
10. Length of current song
11. Repeat the current song or all songs in the play queue
12. Tap to go to the next song, touch and hold to fast-forward the current song
13. Play or pause a song
14. Tap to go to the beginning of the current song, touch and hold to rewind the current song
15. Shuffle songs in the play queue

### Music home screen

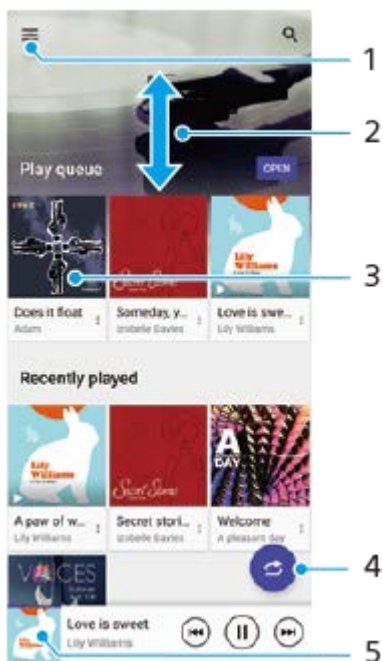

1. Open the Music menu
2. Scroll up or down to view content
3. Tap to start playing a song in the play queue
4. Play all songs in shuffle mode
5. Go to the music player screen

**Note**

- You might not be able to play copyright-protected items.

**Related Topic**

- [Transferring music from a computer to your device](#)
- [Music app features](#)

Smartphone  
Xperia PRO-I XQ-BE52/XQ-BE62/XQ-BE72

## Music app features



---

This section explains features that are useful when using the Music app.

### Editing music information

1. While a song is playing in the Music app, tap the album art in the music player screen and then tap [Edit music info].
2. Edit the information as desired.
3. To set album art, tap  (Edit icon) > [Set image].
4. When you are finished, tap [SAVE].

### Playing music in the background

1. When a song is playing, tap  (Home button) to go to the Home screen.  
The Music app keeps running in the background.  
To open the Music app again, drag the status bar downwards and tap the Music notification. Alternatively, find and tap  (Music icon).

---

#### Related Topic

- [Transferring music from a computer to your device](#)
- [Listening to music](#)

Smartphone

Xperia PRO-I XQ-BE52/XQ-BE62/XQ-BE72

## Wirelessly mirroring the screen of your device on a TV

If your TV or other large display supports mirroring, you can enjoy content from your device on the TV or display without using a cable connection.

### Mirroring the screen of your device on a supported TV

You can use the Screen mirroring feature to mirror the screen of your device on a TV or other large display without using a cable connection.

Wi-Fi Direct<sup>®</sup> technology creates a wireless connection between the two devices, so you can sit back and enjoy your favorite photos from the comfort of your couch. You can also use this feature to listen to music from your device using the TV's speakers.

1. **TV:** Follow the instructions in the User guide of your TV to turn on the Screen mirroring function.
2. **Your device:** Find and tap [Settings] > [Device connection] > [Connection preferences] > [Screen mirroring].
3. Tap [START].
4. Tap [OK] and select a device.

### To stop screen mirroring between devices

1. Find and tap [Settings] > [Device connection] > [Connection preferences] > [Screen mirroring].
2. Tap [Disconnect], then tap [OK].

#### Note

- This function can be used with TVs that support the Screen mirroring feature.
- When using Screen mirroring, do not cover the Wi-Fi antenna area of your device.
- When using Screen mirroring, the image quality may sometimes be negatively impacted if there is interference from other Wi-Fi networks.

#### Hint

- You can also stop screen mirroring by tapping the notification in the status bar of your device. Drag the status bar downwards, tap ▼ (Expand more icon), and then tap [Disconnect] > [OK].
- Tap ⋮ (More icon) for more options.

### Mirroring the screen of your device on your TV while using Chromecast-compliant apps

You can mirror the screen of your device on your TV while using Chromecast-compliant apps such as YouTube.

Tap the Cast button on the app screen, and then select your TV to mirror the screen of your device on the TV. Make sure your device and TV are connected to the same Wi-Fi network.

For more information, visit Google Cast Help at [support.google.com/](https://support.google.com/).

#### Hint

- You may need to log in to the app on the TV with the same Google account that you are using on your device, depending on the app that you are using.

---

**Related Topic**

- [Overview](#)
- [Settings menu](#)

F-703-100-11 Copyright 2021 Sony Corporation

Smartphone  
Xperia PRO-I XQ-BE52/XQ-BE62/XQ-BE72

## Connecting your device to USB accessories

You can use a USB host adapter to connect your device to USB accessories, such as USB mass storage devices, headphones, game controllers, USB keyboards, and USB mice.

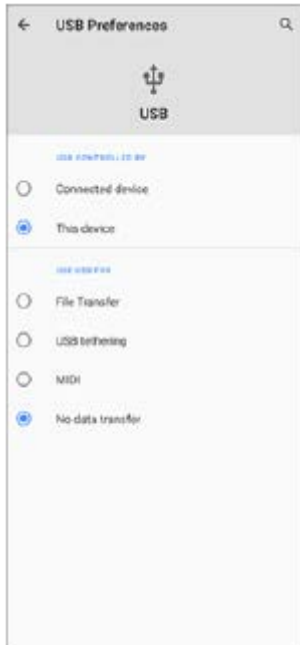

- 1 Connect a USB cable to your device.
- 2 Drag down the status bar, and then tap the USB connection setting notification.
- 3 Tap [Tap for more options.], and then select an option.

### USB Preferences

- **USB controlled by:** You can choose which device controls the other, your device, or the USB-connected device.
- **Use USB for:** You can choose the purpose of the USB connection.
  - **File Transfer:** Manage files or update the device software. This option is used with Microsoft® Windows® computers. Charging is enabled by default.
  - **USB tethering:** Your device can function as a tethering device.
  - **MIDI:** Your device can function as the MIDI input for musical instrument applications.
  - **No data transfer:** Just charge your device when [USB controlled by] is set to [This device]. When [USB controlled by] is set to [Connected device], you can use your device as a power supply and charge the other connected device.

#### Note

- Sony does not guarantee that all USB accessories are supported by your device.
- This device has a capless USB port. If your device gets exposed to water, ensure that the port is completely dry before connecting a USB cable.





Smartphone  
Xperia PRO-I XQ-BE52/XQ-BE62/XQ-BE72

## NFC (Near Field Communication)

---

NFC is a wireless technology with a maximum range of one centimeter, so the devices sharing data must be held close to each other.

The NFC detection area is located on the back of the device. Hold your device close to another device or an NFC reader so that the N-Marks touch. Make sure that both devices have the NFC function turned on and that the screen of your device is active and unlocked.

### Note

- Using certain applications, some NFC functions can be enabled even when the device is switched off. Note that not all devices support this feature.

### To turn the NFC function on or off

1. Find and tap [Settings] > [Device connection] > [Connection preferences] > [NFC].
2. Tap the [NFC] switch to enable or disable the function.

### Note

- You may need to have Wi-Fi or Bluetooth activated on both devices for the connection to work.

### Hint

- You can connect your device to other NFC compatible devices produced by Sony, such as a speaker or a headphone. When establishing this kind of connection, refer to the User guide of the compatible device for more information.

---

### Related Topic

- [Overview](#)
- [Turning the Bluetooth function on or off](#)
- [Settings menu](#)

Smartphone  
Xperia PRO-I XQ-BE52/XQ-BE62/XQ-BE72

## Using your device as a wallet

---

You can use your device to pay for goods without reaching for your real wallet and manage all payment services in one place. When making a payment, remember to turn on the NFC function before you touch your device to a card reader.

- 1 Make sure NFC is enabled on your device.**
- 2 Find and tap [Settings] > [Device connection] > [Connection preferences] > [NFC] > [Contactless payments].**

A list of payment services appears.
- 3 Manage the payment services as desired.**

For example, you can change your default payment service.

### Note

- Mobile payment services may not be available in your region. For Dual SIM devices, NFC-initiated payments are only supported for an NFC-enabled SIM card inserted in SIM card slot 1.

---

### Related Topic

- [NFC \(Near Field Communication\)](#)
- [Settings menu](#)

Smartphone  
Xperia PRO-I XQ-BE52/XQ-BE62/XQ-BE72

## Turning the Bluetooth function on or off

Use the Bluetooth function to send files to other Bluetooth compatible devices, or to connect to handsfree accessories. Bluetooth connections work better within 10 meters (33 feet), with no solid objects in between. Pairing is necessary to connect to other Bluetooth devices.

- 1 Find and tap **[Settings]** > **[Device connection]** > **[Connection preferences]**.
- 2 Tap **[Bluetooth]**.
- 3 Tap the switch to enable or disable the function.

### Hint

- You can also turn Bluetooth on or off from the Quick settings panel.

### Note

- Your device cannot connect wirelessly to all types of Bluetooth devices. Sony does not guarantee that all Bluetooth devices are compatible with your device.
- To secure Bluetooth communications, your device supports a security function compliant with Bluetooth standards. However, security may be insufficient depending on the settings, etc. Be aware of security risks when using the Bluetooth function.
- Please note that Sony is not responsible for any data leakage that might occur when communicating via the Bluetooth connection.

### Related Topic

- [Pairing with another Bluetooth device](#)
- [Settings menu](#)
- [Naming your device](#)
- [Sending items using Bluetooth technology](#)
- [Receiving items using Bluetooth technology](#)

Smartphone

Xperia PRO-I XQ-BE52/XQ-BE62/XQ-BE72

## Naming your device

---

You can give your device a name. This name is shown to other devices after you have turned on the Bluetooth function and your device is set to visible.

- 1 Find and tap **[Settings]** > **[Device connection]** > **[Pair new device]**.
  - 2 Tap **[Device name]**.
  - 3 Enter a name for your device.
  - 4 Tap **[Rename]**.
- 

### Related Topic

- [Turning the Bluetooth function on or off](#)
- [Settings menu](#)

Smartphone  
Xperia PRO-I XQ-BE52/XQ-BE62/XQ-BE72

## Pairing with another Bluetooth device

---

When you pair your device with another device, you can, for example, connect your device to a Bluetooth headset or a Bluetooth car kit, and use these other devices to share music.

Once you pair your device with another Bluetooth device, your device remembers this pairing.

Make sure that the device you want to pair with has the Bluetooth function activated and is visible to other Bluetooth devices.

**1 Find and tap [Settings] > [Device connection] > [Pair new device].**

A list of the available Bluetooth devices appears.

**2 Tap the Bluetooth device that you want to pair with.**

### To connect your device to another Bluetooth device

1. Find and tap [Settings] > [Device connection].
2. Under [Previously connected devices], tap the Bluetooth device to which you want to connect.

### To unpair a Bluetooth device

1. Find and tap [Settings] > [Device connection].
2. Under [Previously connected devices], tap  (Settings icon) beside the name of the device that you want to unpair.
3. Tap [Forget] > [Forget device].

#### Note

- Some Bluetooth devices, for example, most Bluetooth headsets, require you to both pair and connect with the other device.

---

### Related Topic

- [Turning the Bluetooth function on or off](#)
- [Settings menu](#)
- [Naming your device](#)
- [Sending items using Bluetooth technology](#)
- [Receiving items using Bluetooth technology](#)

Smartphone

Xperia PRO-I XQ-BE52/XQ-BE62/XQ-BE72

## Pairing with a Bluetooth remote commander

You can operate Photo Pro and Video Pro on your Xperia device with a Bluetooth remote commander manufactured by Sony (sold separately).

For details on compatible remote commanders, visit the Sony website for your area or consult your Sony dealer or local authorized Sony service facility.

Refer to the instruction manual for the Bluetooth remote commander as well.

- 1 On your Xperia device, launch Photo Pro or Video Pro.
- 2 On your Xperia device, tap [MENU] (for Photo Pro) or ≡ (Settings icon) (for Video Pro).
- 3 On your Xperia device, tap [Bluetooth remote control], and then tap the switch to enable the function.
- 4 On your Xperia device, tap [Pair new controller].
- 5 On the Bluetooth remote commander, perform pairing.
  - GP-VPT2BT: Press and hold the PHOTO button and the T side of the Zoom button at the same time for at least 7 seconds.
  - RMT-P1BT: Press and hold the Shutter-release/REC button and the Focus/Zoom button (either the + button or the - button) at the same time for at least 7 seconds.

For details, refer to the instruction manual for the Bluetooth remote commander.
- 6 On your Xperia device, follow the on-screen instructions.



Select [Pair & connect] and [PAIR] on the notifications and dialogs that appear multiple times when your Xperia device detects the Bluetooth remote commander. The name of the Bluetooth remote commander may be displayed as a Bluetooth address (numerals and letters).

### Note

- When you perform a factory data reset, pairing information is also erased. To use the Bluetooth remote commander, perform pairing again.
- If the Bluetooth connection is unstable, remove any obstacles such as people or metal objects from between your Xperia device and the paired Bluetooth remote commander.
- If the function does not work properly, check the following notes and then try pairing again.
  - Confirm that the Bluetooth remote commander is not connected with other devices.
  - Confirm that you are not operating your Xperia device using other Bluetooth remote commander.
  - Check if the Airplane mode of your Xperia device is set to off.
  - Check if the Bluetooth function of your Xperia device is set to on.
  - Unpair the Bluetooth remote commander.

### Hint

- Once you pair with the Bluetooth remote commander, you can operate both Photo Pro and Video Pro.
- Turn the [Bluetooth remote control] function on or off individually for Photo Pro and Video Pro.

- To change the name of the paired Bluetooth remote commander, find and tap [Settings] > [Device connection], tap  (Settings icon) beside the name of the paired Bluetooth remote commander, and then tap  (Edit icon).

## To use Camera endurance mode

Your device may limit certain functions as a precaution when under intensive use. By turning on Camera endurance mode, you can maintain high performance for a longer period of time.





1. Tap [MENU] (for Photo Pro) or  (Settings icon) (for Video Pro).
2. Tap [Bluetooth remote control] > [Camera endurance mode], and then tap the switch to enable the function.

### Note

- Camera endurance mode will be made available through a software update. Software rollouts are a phased process; the timing and availability vary by market and/or operator.

## Bluetooth remote commander connection status icons

You can check the connection status of the Bluetooth remote commander on the viewfinder when [Bluetooth remote control] is set to on while using Photo Pro or Video Pro.

-  (Bluetooth remote commander connection icon): Bluetooth remote commander operations are enabled.
-  (Bluetooth remote commander disconnection icon): Bluetooth remote commander operations are disabled.
-  (Camera endurance mode available icon): Camera endurance mode is turned on and available.
-  (Camera endurance mode unavailable icon): Camera endurance mode is turned on but unavailable because you are not using the Bluetooth remote commander to operate Photo Pro and Video Pro.

### Hint

- The Bluetooth connection is only active while you are operating your Xperia device using the Bluetooth remote commander.

## To unpair the Bluetooth remote commander

1. Find and tap [Settings] > [Device connection].
2. Under [Previously connected devices], tap  (Settings icon) beside the name of the Bluetooth remote commander that you want to unpair.
3. Tap [Forget] > [Forget device].

## To operate the Bluetooth remote commander

You can shoot images and record videos by pressing buttons on the Bluetooth remote commander. For more information about operating the Bluetooth remote commander, refer to the Help Guide for the Bluetooth remote commander.

### Hint

- To switch the lenses of the main camera, press the C1 button on the Bluetooth remote commander.

---

## Related Topic

- [Turning the Bluetooth function on or off](#)
- [BASIC \(Basic\) mode overview](#)
- [AUTO/P/S/M mode overview](#)
- [Launching Video Pro](#)
- [Settings menu](#)





Smartphone  
Xperia PRO-I XQ-BE52/XQ-BE62/XQ-BE72

## Sending items using Bluetooth technology

---

Use Bluetooth technology to share items with other Bluetooth compatible devices such as phones or computers. You can send the following kinds of items:

- Photos and videos
- Music and other audio files
- Web pages

Make sure the Bluetooth function is turned on for the receiving device, and that the device is visible to other Bluetooth devices.

- 1 Open the app that contains the item you want to send.**
- 2 Touch and hold or open the item, and then tap  (Share icon).**
- 3 Select [Bluetooth], and then tap the name of the receiving device.**  
Turn on the Bluetooth function if prompted.
- 4 On the receiving device, accept the connection if prompted.**
- 5 On your device, confirm the transfer to the receiving device, if prompted.**
- 6 On the receiving device, accept the incoming item.**

---

### Related Topic

- [Turning the Bluetooth function on or off](#)
- [Settings menu](#)
- [Naming your device](#)
- [Pairing with another Bluetooth device](#)
- [Receiving items using Bluetooth technology](#)

Smartphone  
Xperia PRO-I XQ-BE52/XQ-BE62/XQ-BE72

## Receiving items using Bluetooth technology

---

Use Bluetooth technology to share items with other Bluetooth compatible devices such as phones or computers. You can receive the following kinds of items:

- Photos and videos
- Music and other audio files
- Web pages

Make sure that the Bluetooth function is on and is visible to other Bluetooth devices.

- 1 On the transmitting device, send the data to your device.**
- 2 When you are notified of an incoming file to your device, drag the status bar downwards and tap the notification to accept the file transfer.**
- 3 Tap [Accept] to start the file transfer.**
- 4 To view the progress of the transfer, drag the status bar downwards.**
- 5 To open a received item, drag the status bar downwards and tap the relevant notification.**

### To view files you have received using the Bluetooth connection

1. Find and tap [Settings] > [Device connection] > [Connection preferences].
2. Tap [Files received via Bluetooth].

---

#### Related Topic

- [Turning the Bluetooth function on or off](#)
- [Settings menu](#)
- [Naming your device](#)
- [Pairing with another Bluetooth device](#)
- [Sending items using Bluetooth technology](#)

Smartphone  
Xperia PRO-I XQ-BE52/XQ-BE62/XQ-BE72

## About the Support app

---

Use the Support app to find device and software information. You can read support topics or use helpful applications such as the device test.

### Note

- Support contact information is available from the Contact us menu even without a network connection.

### 1 Find and tap (Support icon).

### Hint

- Connect to the internet when using the Support app for the best available support.

Smartphone  
Xperia PRO-I XQ-BE52/XQ-BE62/XQ-BE72

## Accessibility

---

### Accessibility settings

Android provides many accessibility features such as [Magnification], [Font size], [Color correction], [TalkBack], and more.

You can find accessibility features under [Settings] > [Accessibility].

Visit Google Accessibility Help at [support.google.com/accessibility/android](https://support.google.com/accessibility/android) for more information.

### Real-Time Text

Real-time Text (RTT) is a text service that carriers provide in certain countries/regions. It allows each character in a message to be read as it is typed. Check with your carrier to learn whether RTT is available with your service plan. Please note that in order to contact 911 using RTT in the United States, your phone may need to have a SIM card installed. For more information about using RTT on your phone, please visit [support.google.com/accessibility/android](https://support.google.com/accessibility/android).

Smartphone  
Xperia PRO-I XQ-BE52/XQ-BE62/XQ-BE72

## Using your device in wet and dusty conditions

Your device is water- and dust-resistant with ratings of IPX5/IPX8 and IP6X. However, remember: all USB ports and connectors must be completely dry before use and attached covers should be firmly closed. Your device has a Nano SIM/Memory card slot with an attached cover. You should not put the device completely underwater, or expose it to seawater, salt water, chlorinated water, or liquids such as drinks. Your warranty does not cover damage or defects caused by abuse or use of your device in disregard of instructions from Sony. For information about warranty, please read the Important information provided under [Settings] > [About phone] > [Legal information] on your device.

### To close attached covers

1. Press the highlighted positions as illustrated and make sure that there are no gaps between the cover and your device.  
(A): Cover

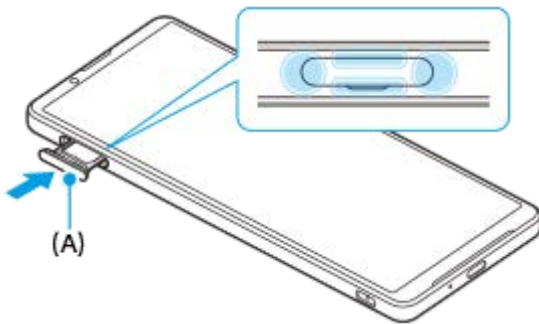

### To dry your device

1. Using a micro-fiber cloth, wipe away any excess moisture from your device.



2. With the device held firmly and the USB port facing downwards, shake the device vigorously at least 20 times. Reverse the orientation and shake the device again 20 times.

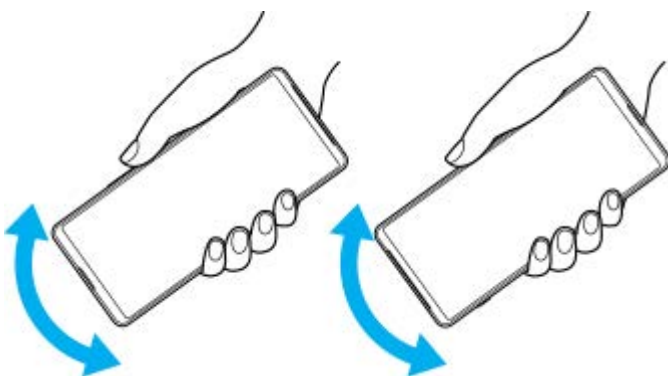

3. Use a micro-fiber cloth to wipe away any remaining moisture. Wipe keys, ports, and parts of your device such as speakers, microphones, sensors, cameras, etc. as shown in the illustration.

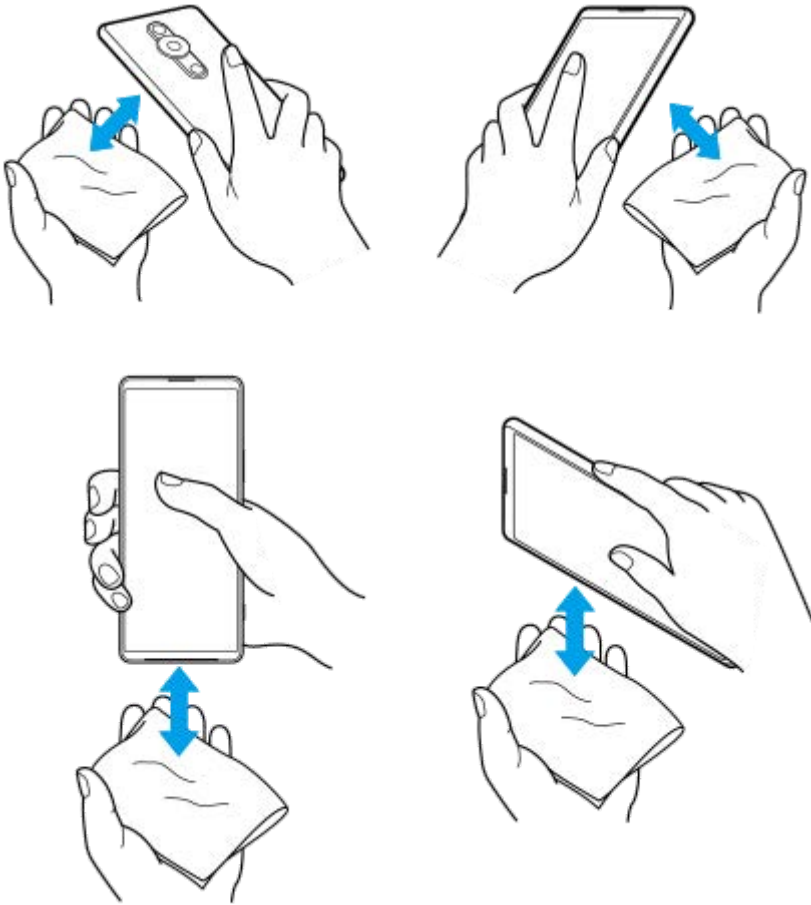

4. Leave your device for at least a couple of hours and ensure that it is completely dry before use.

Smartphone  
Xperia PRO-I XQ-BE52/XQ-BE62/XQ-BE72

## Legal information

---

This Help Guide is published by Sony Corporation (herein after referred to as “Sony”) or its local affiliated company, without any warranty. Improvements and changes to this Help Guide necessitated by typographical errors, inaccuracies of current information, or improvements to programs and/or equipment, may be made by Sony at any time and without notice. Such changes will, however, be incorporated into new editions of this Help Guide. All illustrations are for illustration purposes only and may not accurately depict the actual device.

All product and company names mentioned herein are the trademarks or registered trademarks of their respective owners. All other trademarks are property of their respective owners. Any rights not expressly granted herein are reserved. Visit <https://www.sony.net/Products/smartphones/trademarks-and-copyright.html> for more information.

This Help Guide may reference services or applications provided by third parties. Use of such programming or services may require separate registration with the third-party provider, payment of fees or provision of credit card information, as well as be subject to additional terms of use, change, interruption or discontinuance at any time. For applications accessed on or through a third-party website, please review such websites’ terms of use and applicable privacy policy in advance. Sony does not warrant or guarantee the availability or performance of any third-party application, websites, or offered services. In the event software accompanying or provided in conjunction with your device is provided with additional terms and conditions, such provisions shall also govern your possession and usage of the software.

Your device has the capability to download, store, and forward additional content, for example, music or videos. The use of such content may be restricted or prohibited by rights of third parties, including but not limited to restriction under applicable copyright laws. You, and not Sony, are entirely responsible for additional content that you download to or forward from your device. Prior to your use of any additional content, please verify that your intended use is properly licensed or is otherwise authorized. Sony does not guarantee the accuracy, integrity or quality of any additional content or any other third-party content. Under no circumstances will Sony be liable in any way for your improper use of additional content or other third-party content.

This product is licensed under the MPEG-4 visual and AVC patent portfolio licenses for the personal and non-commercial use of a consumer for (i) encoding video in compliance with the MPEG-4 visual standard (“MPEG-4 video”) or the AVC standard (“AVC video”) and/or (ii) decoding MPEG-4 or AVC video that was encoded by a consumer engaged in a personal and non-commercial activity and/or was obtained from a video provider licensed by MPEG LA to provide MPEG-4 and/or AVC video. No license is granted or shall be implied for any other use. Additional information including that relating to promotional, internal and commercial uses and licensing may be obtained from MPEG LA, L.L.C. See [www.mpegla.com](http://www.mpegla.com). MPEG Layer-3 audio decoding technology licensed from Fraunhofer IIS and Thomson.

**Note:** Sony advises users to backup their personal data and information.

SONY WILL NOT BE LIABLE FOR ANY LOSS, DELETION AND/OR DATA-OVERWRITING OF PERSONAL DATA OR FILES STORED ON YOUR DEVICE (INCLUDING BUT NOT LIMITED TO CONTACTS, MUSIC TRACKS AND PICTURES) ARISING OUT OF ANY UPDATE OF YOUR DEVICE BY ANY OF THE METHODS DESCRIBED IN THIS HELP GUIDE OR DOCUMENTATION.

IN NO EVENT SHALL SONY’S OR ITS SUPPLIERS’ TOTAL LIABILITY TO YOU FOR ANY AND ALL DAMAGES, LOSSES AND CAUSES OF ACTION (WHETHER IN CONTRACT OR TORT, INCLUDING, BUT NOT LIMITED TO NEGLIGENCE OR OTHERWISE) EXCEED THE AMOUNT ACTUALLY PAID BY YOU FOR YOUR DEVICE.

Smartphone  
Xperia PRO-I XQ-BE52/XQ-BE62/XQ-BE72

## Warranty, SAR, and usage guidelines

---

For information about warranty, SAR (Specific Absorption Rate), and safety guidelines, please read the Important information provided under [Settings] > [About phone] > [Legal information] on your device.