



# User Manual

D32QOE



## Important Safety Precautions

1. Please read all the instructions carefully before using this product.
2. BE SURE TO unplug the power cord when cleaning LCD. Never clean it with liquid detergent or spraying detergent, but wipe it with wet soft cloth. If it is still not clean, please use special detergent for LCD.
3. DO NOT use accessories not authorized by the manufacturer, otherwise they may incur danger.
4. When disconnecting the power cord of display or power adapter, always remember to hold the plug instead of pulling the wire to unplug the power cord.
5. Keep the display away from water sources such as bath tub, washbasin, sink or washing machine. DO NOT place the display on wet floor or near a swimming pool, or press LCD surface with fingers or hard objects.
6. The grooves and openings on the back and bottom of the shell are for ventilation purpose and also for guaranteeing the reliability of the elements and preventing them from overheating; in order to prevent the vents from blocking; DO NOT place the display on bed, sofa, carpet or other similar surface; DO NOT place the display near to or on heat radiator or heater; DO NOT place the display into embedded device, unless it is provided with adequate ventilating equipment.
7. Only the type of power source indicated on the nameplate applies to this display. If you have any question on the type of power source you use, please consult the dealer of the display or local administration of power supply.
8. For safety, the display or the power adapter is equipped with three-pin plug power cord. The third pin of this plug is for grounding, and only applicable to socket that is correctly grounded. In case that your socket is not available for the plug, please contact electrician to replace the socket.
9. Since there is high voltage or other risks when the shell is opened or moved, please DO NOT repair the display by yourself, but request qualified maintenance staff to carry out full maintenance.
10. In one of the following cases, please unplug the display or the power adapter and ask qualified maintenance staff for maintenance:
  - a. The power cord or the plug is impaired or worn.
  - b. The display falls off or the shell is damaged.
  - c. The display is obviously abnormal.
11. Please place the display in a cool, dry and well ventilated place.
12. Store the display in temperature range of -20°C~55°C, beyond which the display may be damaged permanently.

## 1. Product Description

### 1.1 General

This display is a high-performance smart multi-frequency scanning display. It adopts active-matrix TFT-LED backlight liquid screen and is controlled with MCU digital technology. With compact and thin appearance and adaptor supply, it is suitable for narrow work space.

### 1.2 Packing list

Please check the following items in the packing case before installation:

- One LCD display (including the base)
- One HDMI signal line, One power cord, One adaptor
- One User Manual

If any items are missing, please contact with the dealer.

**NOTE: As for the accessories, please refer to the exact packing. please keep all the packing materials well for you may use them to pack these items when you need to move them.**

## 2. Installation and Connection

### 2.1 Display installation

#### Installation instructions

- This machine should be installed adjacent to an easily pluggable AC power socket.
- For the sake of safety, we suggest that suitable wall-mounted bracket or base be used.
- In order to prevent injury, this machine shall be placed on a stable and level surface or fixed on a firm wall.
- For wall-mounting, please ask a professional to do so. Improper installation may cause instability of this machine.
- DO NOT place this machine in places with mechanical vibration.
- DO NOT place this machine in places where insects are accessible.
- DO NOT install this machine directly opposite to air-conditioner, otherwise its inner panel may be dewed and cause failure.
- DO NOT place this machine in places with strong electromagnetic field, otherwise it may be interfered by the electromagnetic wave and get damaged.

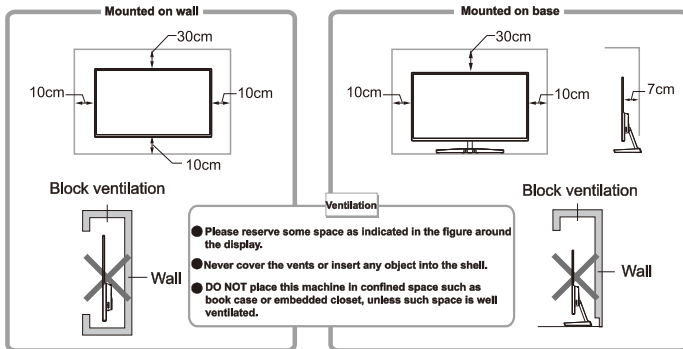

### 2.2 Signal line connection

Connect the signal line to output interfaces signal of VGA/HDMI/DP signals of PC, and then connect the other end of the signal line to the corresponding signal input port of the display.

### 2.3 Earphone connection

This machine supports earphone audio output and no speaker.

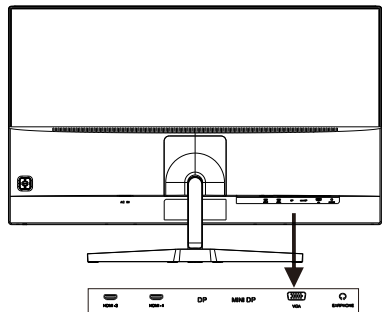

### 3. Operation of Display

The OSD control buttons are shown as the figure. Models of the same product series are only different in button position and panel pattern, please refer to the practical model.

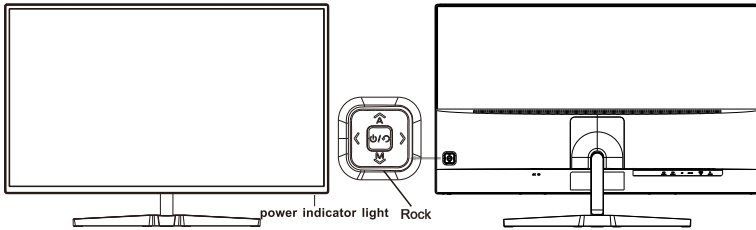

#### 3.1 Power indicator light

When the display is working normally, the indicator light is on with blue color; when there is no signal input, the machine will enter the energy saving state/standby state, the indicator light blinks with red color; when the signals are sent again, the machine returns to normal work; when the display is powered off, the indicator light is off. As the display is still powered in the standby state, for the sake of safety, the power cord should be unplugged when the display is not used.

#### 3.2 Introduction to rocker functions

Initial state:

Rocker Up	Signal source input
Rocker Down	Menu display
Rocker Left	Backlight adjustment shortcut key
Rocker Right	Volume adjustment shortcut key
Press Rocker	Power ON/OFF

Enter the function menu:

Rocker Up	Back
Rocker Down	OK
Rocker Left	Select the menu of the same level; the progress bar is -.
Rocker Right	Select the menu of the same level; the progress bar is +.
Press Rocker	Power ON/OFF

#### 3.3 Safety protection

When the video signals of PC exceeds the frequency range of the display, the horizontal and field synchronizing signals will be shut down to protect the display. Then, you have to set the PC output frequency to an acceptable range so as to make the display work normally.

#### 4. Basic Troubleshooting

Phenomenon	Troubleshooting
1. Light out/power indicator light is off	Check whether the display and the socket are well connected to power, and whether the display is in the shutdown mode.
2. Image blurring, over-large, over-small, etc.	Enter the menu "Image Setting" and select "Auto Image Adjust" to automatically adjust the display.
3. Image over dark	Enter the menu "Brightness and Contrast" to adjust the brightness and contrast of the display.
4. Display over heat	Leave at least 5cm of distance for ventilation around the display and do not place articles on the display.
5. Dark/ light spots when powering on	This is a normal phenomenon. It is due to the backlight illuminates unevenly at the initial phase of powering on caused by temperature difference. The backlight can illuminates normally after 20 minutes, and then the dark/light spots will be corrected.
6. Image distortion, blinking, shaking	Check computer setting, select the correct resolution and re-adjust the refresh frequency.
7. Power off noise	It is a normal phenomenon caused by display discharging in the process of powering off.

#### 5. Technical Specifications of Product

Panel size	32"
Optimal working resolution	2560×1440@60Hz
Power input	DC 12V/4.5A
Product has been filed on China energy label website	Yes
Blue-light filtering	Support
Flicker-free	Support
Requirements for working environment	
Barometric pressure	86kpa~104kpa
Working temperature and humidity	5°C~40°C 10%~85%
Warehousing temperature and humidity	-20°C~55°C 5%~95%
Packing size (W * H * T) and weight	
Unpacked size (W * H * T) (with base)	724×503×183(mm <sup>3</sup> )
Packing size (W * H * T)	835×535×125(mm <sup>3</sup> )
Net weight	5.5kg
Gross weight	8.0kg

## Power supply management system

Mode	Power consumption
Normal working	$\leq 52W$
Standby	$\leq 0.5W$

**Remarks:** All technical specifications in this manual and external packages are subject to change without further notice. In case that there is subtle difference between this manual and practical operation, please follow practical operation.

## 6. Instruction of Base Installation

1. Hold and press the hat and then lift it up from the back cover (Pic-1)
2. Install the metal support to the back screw holes as in Pic-2, use 4 PCS machine screws to lock the support and back.
3. Cover the small hat cross the support as in Pic-3
4. Install the base to the screw hole below the support as the arrow direction, and lock 1 PCS machine screw as in Pic-4

Note: disassemble the base according to the opposite order above.

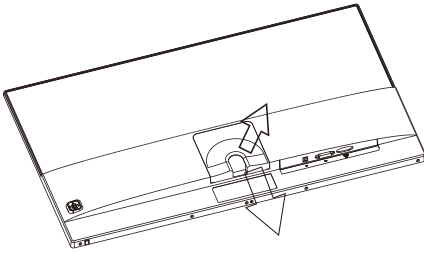

Pic-1

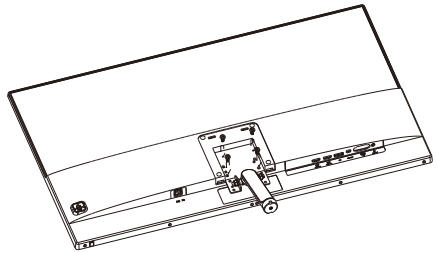

Pic-2

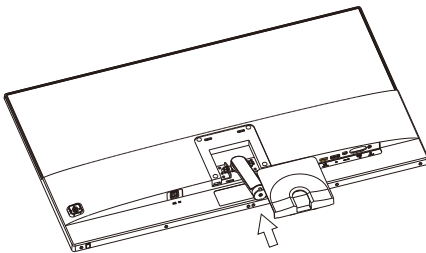

Pic-3

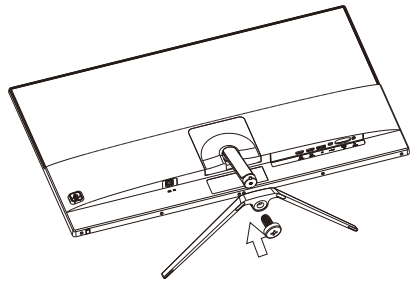

Pic-4

**Remarks:** 1. In case that there is subtle difference between this manual and the monitor, please follow the practical goods.

## Marking

Declares that design and manufacturing of this product complies with the European directives for CE-marking as stated below:

2014/35/EU(LVD)

2014/30/EU(EMC)

2011/65/EU(RoHs)



The terms HDMI, HDMI High-Definition Multimedia Interface, and the HDMI Logo are trademarks or registered trademarks of HDMI Licensing Administrator, Inc.

