



RAZER VIPER ULTIMATE

MASTER GUIDE

Meet the **Razer Viper Ultimate** that's powered by an ultra-fast wireless technology engineered for pro-grade performance. Featuring 20,000 DPI resolution for extremely precise tracking, optical mouse switches that actuate at the speed of light, and up to 70 continuous hours of play.

CONTENTS

1. WHAT'S INSIDE	3
2. WHAT'S NEEDED	4
3. LET'S GET YOU COVERED	5
3. TECHNICAL SPECIFICATIONS.....	6
4. GETTING STARTED	7
5. CONFIGURING YOUR RAZER VIPER ULTIMATE.....	11
6. SAFETY AND MAINTENANCE	26
7. LEGALESE.....	28

1. WHAT'S INSIDE

RAZER VIPER ULTIMATE

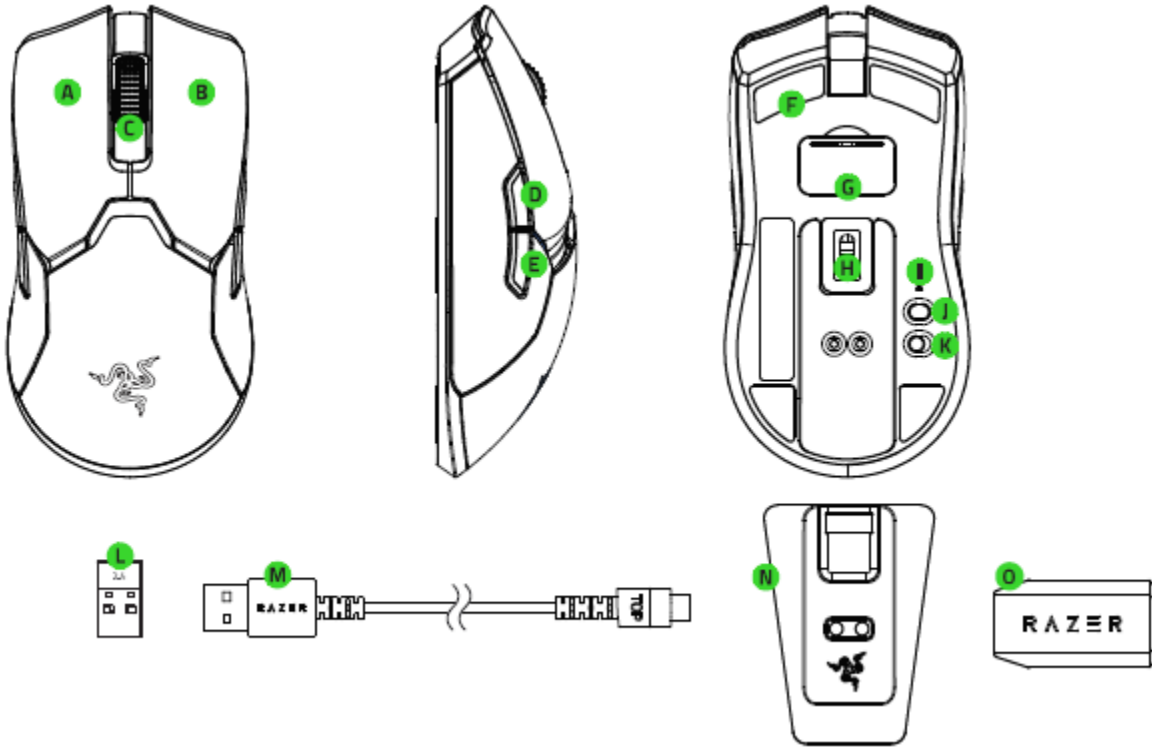

- A. Left mouse button
- B. Right mouse button
- C. Scroll wheel
- D. Mouse button 5
- E. Mouse button 4
- F. Ultraslick mouse feet
- G. Wireless USB dongle compartment
- H. Razer™ Focus+ 20,000 DPI Optical Sensor
- I. DPI indicator
- J. DPI cycle up button
- K. Power on/off switch
- L. Wireless USB dongle
- M. Charging Cable
- N. Razer Chroma™ Mouse Charging Dock*
- O. USB dongle adapter*

**Subject to change based on current retail version*

i Default DPI stages are as follows: 800, 1800, 4000, 9000, and 20000. The DPI stages can be customized using Razer Synapse 3.

2. WHAT'S NEEDED

PRODUCT REQUIREMENTS

- PC with a free USB port

RAZER SYNAPSE REQUIREMENTS

- Windows®7 64-bit (or higher)
- Internet connection

3. LET'S GET YOU COVERED

You've got a great device in your hands complete with a 2-year limited warranty coverage. Now maximize its potential and score exclusive Razer benefits by registering at razerid.razer.com

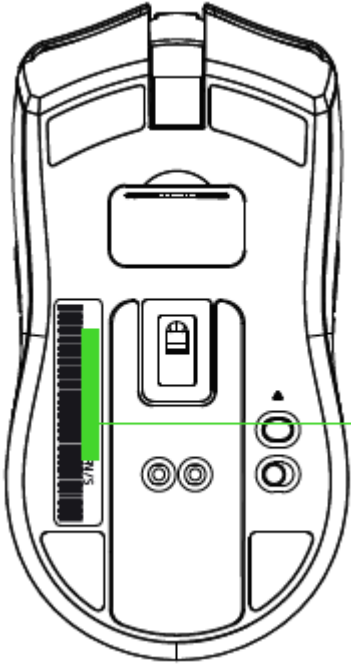

*Your product's serial number
can be found here.*

3. TECHNICAL SPECIFICATIONS

TECHNICAL SPECIFICATIONS

- True 20,000 DPI Focus+ optical sensor with 99.6% resolution accuracy
- Up to 650 inches per second (IPS) / 50 G acceleration
- Advanced Lift-off/Landing distance customization
- Hyperspeed wireless technology
- Eight independently programmable buttons
- Razer™ Optical Mouse Switches rated for 70M clicks
- True Ambidextrous shape
- Gaming-grade tactile scroll wheel
- On-The-Fly Sensitivity Adjustment (Default stages: 400/800/1600/2400/3200)
- Hybrid On-board and Cloud Storage (4+1 profiles)
- Razer Synapse 3 enabled
- Razer Chroma™ lighting with true 16.8 million customizable color options
- Inter-device color synchronization
- Wired and Wireless usage modes.
- 2.4 GHz dongle
- 1.8 m / 6 ft Speedflex cable for charging and wired use
- Razer Mouse charging dock compatible
- Battery life: Approximately 70 hours (without lighting) (Battery life depends on usage settings)

APPROXIMATE SIZE & WEIGHT

- Length: 127 mm / 5.0 in
- Width: 66 mm / 2.60 in
- Height: 38 mm / 1.50 in
- Weight: 74 g / 0.163 lbs*
- Cable length: 2.1 m / 6.89 ft

* *Excluding cable*

4. GETTING STARTED

CHARGING YOUR RAZER VIPER ULTIMATE

Plug the charging cable from your computer's USB port to your Viper Ultimate.

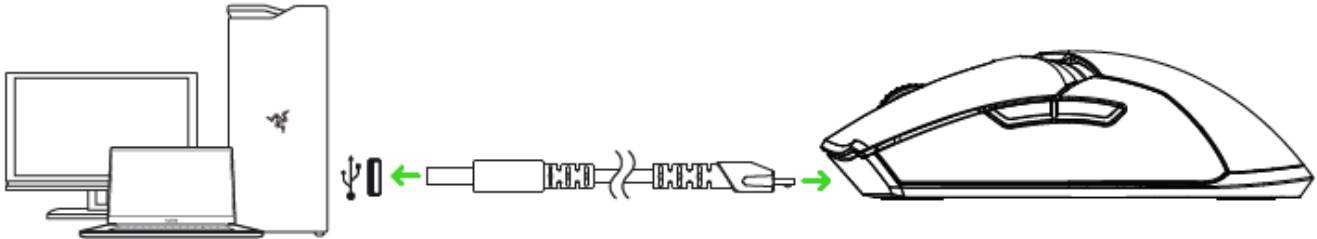

i *This connection also acts as the wired mode for your Razer device.*

For best results, please fully charge your Razer Viper Ultimate before using it for the first time. A depleted battery will be fully charged in approximately 4 hours. If the Razer Viper Ultimate has not been used for an extended period, you may need to recharge it before use.

The Razer Viper Ultimate requires a USB connection that is able to supply sufficient power to charge the battery. The battery charging process of the Razer Viper Ultimate may be affected if connected to a non-powered USB hub or non-powered USB ports found on certain keyboards and other peripherals. When in doubt, it is preferable to connect the Razer Viper Ultimate directly to the USB port of your computer.

LOW POWER INDICATOR

The Razer Viper Ultimate's scroll wheel will blink red twice in repeated intervals to indicate that the battery's power is less than 5%. This lighting sequence will repeat until the battery is drained or the mouse is connected to the PC via the charging cable.

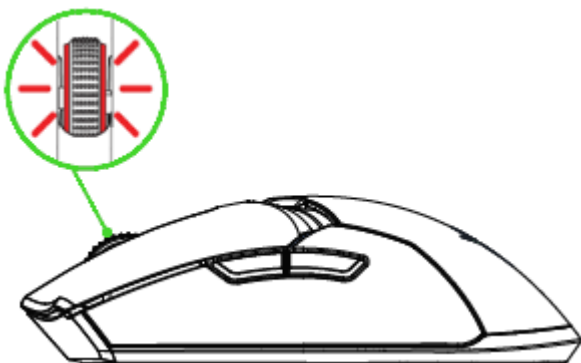

i *The indicator percentage can be customized using Razer software.*

USING THE USB WIRELESS DONGLE

1. Remove the compartment cover from your Razer Viper Ultimate.



2. Remove the USB wireless dongle from your mouse.



3. Reattach the compartment cover onto your Razer Viper Ultimate and make sure it is securely fastened.



4. Insert the USB wireless dongle into your computer's USB port.



5. Switch on the Razer Viper Ultimate.

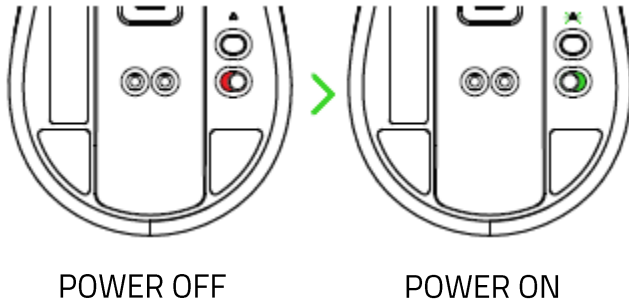

Your Razer Viper Ultimate is now ready for use in wireless mode.

USING THE CHARGING DOCK

1. Plug the charging cable from your computer's USB port to the charging dock.

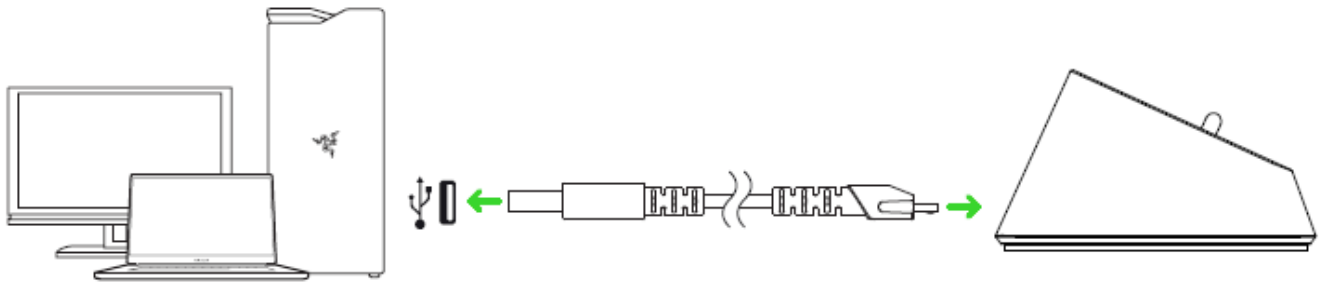

2. Insert the USB wireless dongle into your computer's USB port.

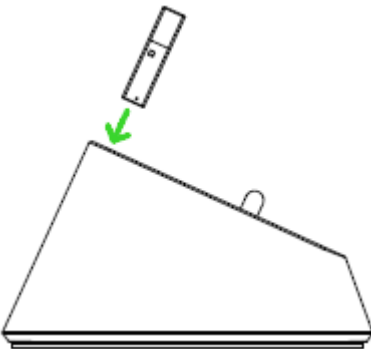

You can use the charging dock to replenish your mouse's battery and to extend the reach of your USB wireless dongle. You can also connect to Razer Synapse and place your Razer Viper Ultimate on the charging dock to view the mouse's current battery status.

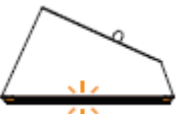
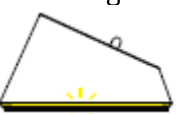
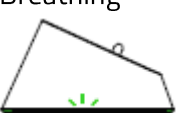
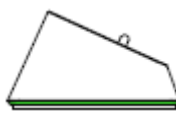
Color	Battery Percentage	Effect
Red	<25%	Breathing 
Orange	26%-50%	Breathing 
Yellow	51%-75%	Breathing 
Green	76%-99%	Breathing 
Green	100%	Static 

USING THE WIRELESS USB DONGLE ADAPTER

Use the USB dongle adapter to easily access and extend the reach of your USB dongle.

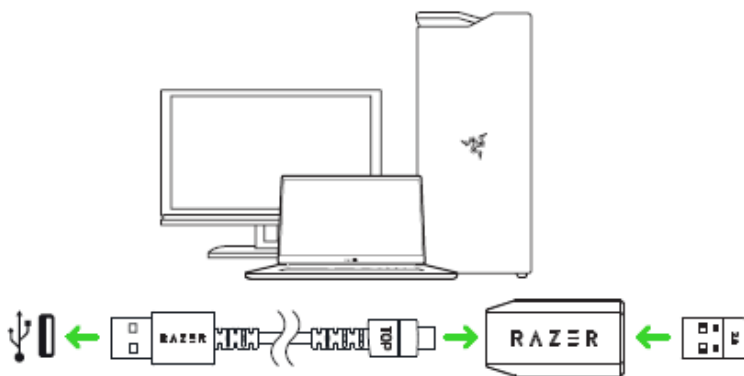

5. CONFIGURING YOUR RAZER VIPER ULTIMATE

Disclaimer: The features listed here require you to log into Razer Synapse 3. These features are also subject to change based on the current software version and your Operating System.

SYNAPSE TAB

The Synapse tab is your default tab when you first launch Razer Synapse 3. This tab allows you to navigate the Dashboard subtab.

Dashboard

The Dashboard subtab is an overview of your Razer Synapse 3 where you can access all your Razer devices, modules, and online services.

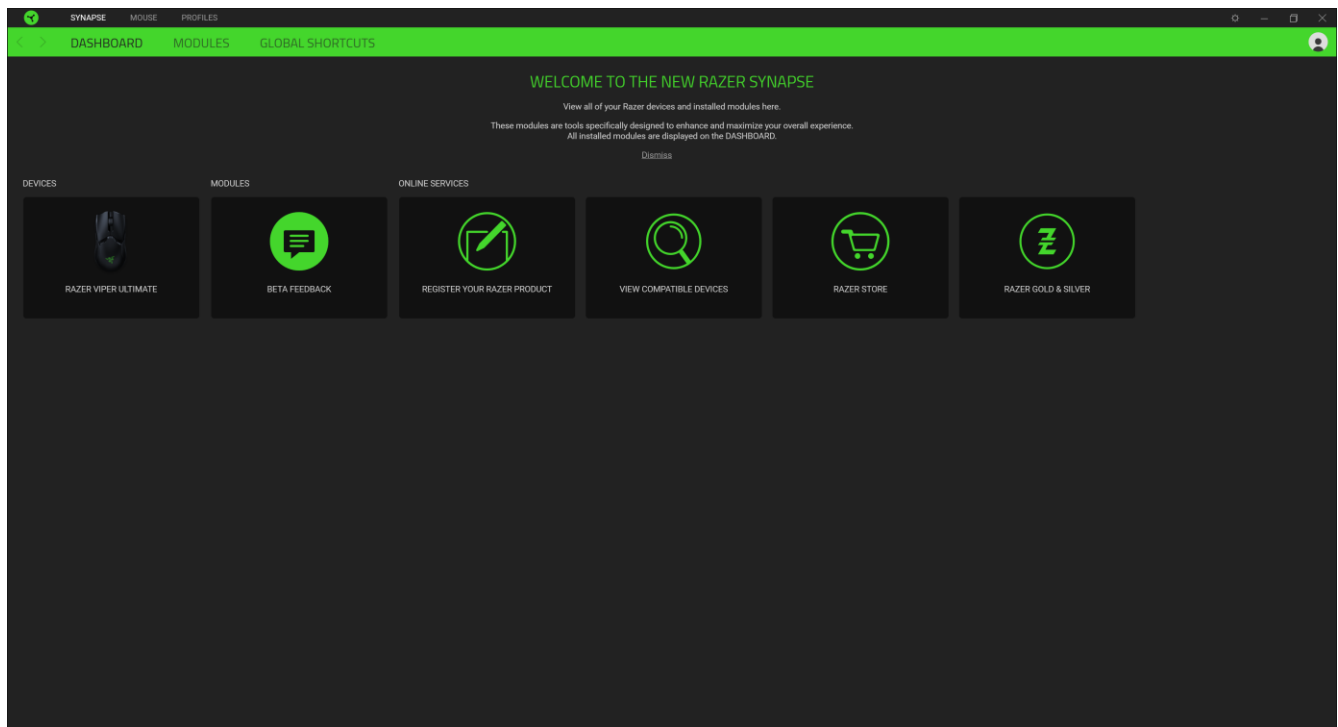

MOUSE TAB

The Mouse tab is the main tab for your Razer Viper Ultimate. From here, you can change your device's settings such as button assignment, DPI sensitivity, and lighting. Changes made under this tab are automatically saved to your system and cloud storage however, you need to click the Save button () to open the storage slots for your Razer device's on-board memory then drag and drop the profiles you want to store.

Customize

The Customize subtab is for modifying your mouse's button assignments.

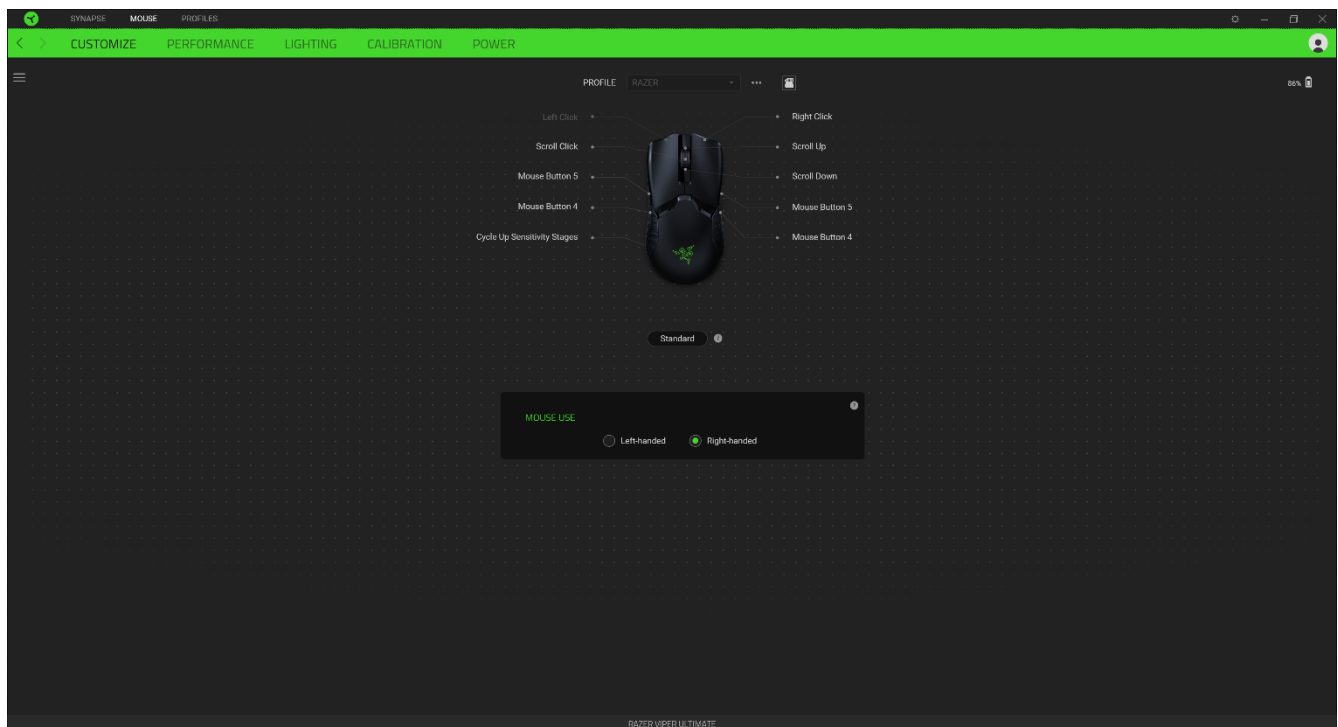

Profile

Profile is a data storage for keeping all your Razer peripheral's settings. By default, the profile name is based on your system's name. To add, rename, duplicate, or delete a profile, simply press the Miscellaneous button ().

Stored Profiles

Your Razer Viper Ultimate can store up to 5 profiles from Razer Synapse 3, which you can use even on systems that do not have Razer Synapse 3 installed. Pressing the profile button will cycle through the different profiles, with the profile indicator's color showing which profile is currently selected.

DPI	Designated color
800	Red 
1800 (Default)	Green 
4000	Blue 
9000	Cyan 
20000	Yellow 

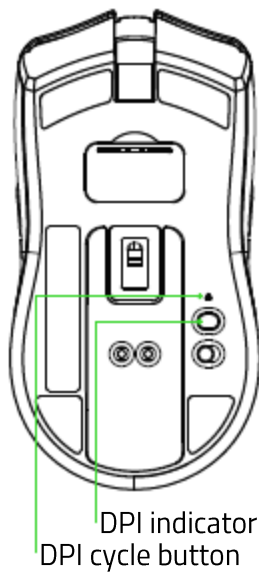

Mouse Use

This option enables you to switch the orientation of your primary and secondary mouse functions to accommodate left-handed or right-handed users.

Hypershift

Hypershift mode is a secondary set of button assignments that is activated when the Hypershift key is held down. By default, the Hypershift key is assigned to the FN key of your Razer Synapse 3 supported keyboard however, you can also assign any mouse button as a Hypershift key.

Sidebar

Clicking the Sidebar button (☰) will reveal all current button assignments for your Razer Viper Ultimate.

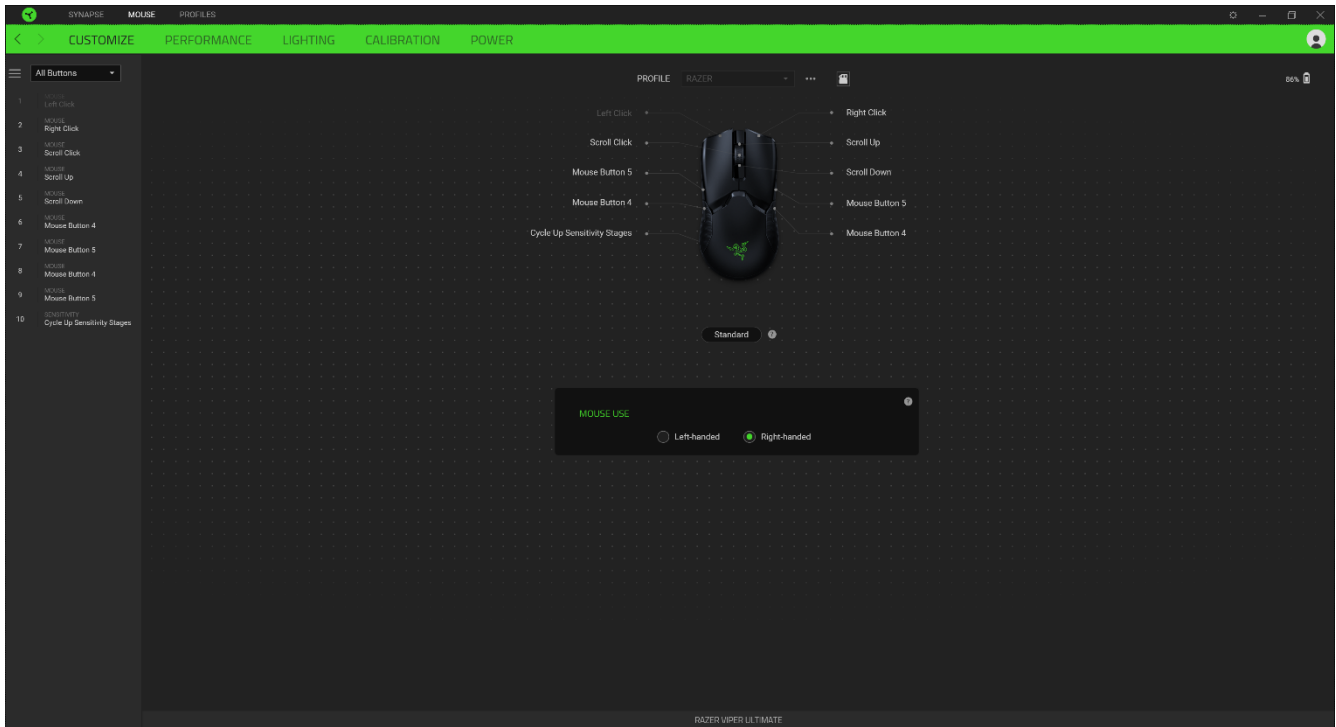

Alternatively, you can skip to a specific button assignment by selecting it on the Customize tab.

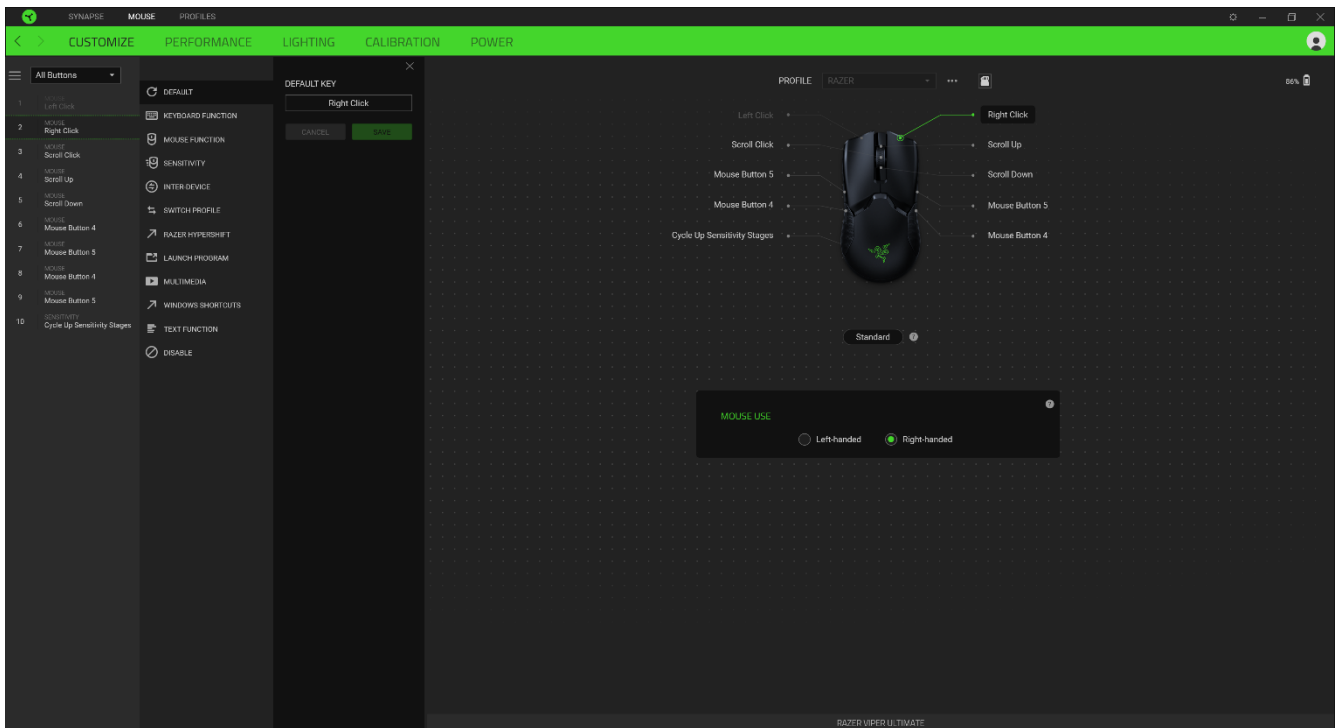

Upon selecting a button assignment, you may then change it to one of the following functions:

Default

This option enables you to return the mouse button to its original setting.

Keyboard Function

This option changes the button assignment into a keyboard function. You can also choose enable Turbo mode which allows you to emulate repeatedly pressing the keyboard function while the button is held down.

Mouse Function

This option substitutes the current button assignment into another mouse function. Listed below are the functions which you can choose from:

- Left Click - Performs a left mouse click using the assigned button.
- Right Click - Performs a right mouse click using the assigned button.
- Scroll Click - Activates the universal scrolling function.
- Double Click - Performs a double left click using the assigned button.
- Mouse Button 4 - Performs a "Backward" command for most internet browsers.
- Mouse Button 5 - Performs a "Forward" command for most internet browsers.
- Scroll Up - Performs a "Scroll Up" command using the assigned button.
- Scroll Down - Performs a "Scroll Down" command using the assigned button.
- Scroll Left - Performs a "Scroll Left" command using the assigned button.
- Scroll Right - Performs a "Scroll Right" command using the assigned button.
- Repeat Scroll Up - Continuously performs a "Scroll Up" command while the assigned button is pressed.
- Repeat Scroll Down - Continuously performs a "Scroll Down" command while the assigned button is pressed.

You can also choose to enable Turbo mode in some of the mouse functions which allow you to emulate repeatedly pressing and releasing said function while the button is held down.

Sensitivity

This function allows you to manipulate the DPI setting of your Razer Viper Ultimate with a touch of a button. Listed below are the Sensitivity options and their description:

- Sensitivity Clutch - Changes the sensitivity to a predefined DPI while the designated button is held down. Releasing the button will return it to the previous sensitivity.
- Sensitivity Stage Up - Increases the current sensitivity by one stage.
- Sensitivity Stage Down - Decreases the current sensitivity by one stage.
- On-The-Fly Sensitivity - Pressing the designated button and moving the scroll wheel either up or down will increase or decrease the current DPI respectively.
- Cycle Up Sensitivity Stages - Increases the current sensitivity stage by one. Once it reaches the highest sensitivity stage, it will return to stage 1 when the button is pressed again.
- Cycle Down Sensitivity Stages - Decreases the current sensitivity stage by one. Once it reaches stage 1, it will return to the highest sensitivity stage when the button is pressed again.

[Click here to learn more about Sensitivity Stages](#)

M Macro

A Macro is a prerecorded sequence of keystrokes and button presses that is executed with precise timing. By setting the button function to Macro, you can conveniently execute a chain of commands. [Click here to learn more about Macros](#)

↔ Switch Profile

Switch Profile enables you to quickly change profiles and load a new set of button assignments. An on-screen notification will appear whenever you switch profiles.

⚙️ Switch Lighting

Switch Lighting allows you to easily switch between the current lighting effect to a custom lighting effect. [Click here to learn more about Advanced Chroma Effects](#)

↗️ Razer Hypershift

Setting the button to Razer Hypershift will allow you to activate Hypershift mode as long as the button is held down.

🖱️ Launch Program

Launch Program enables you to open an app or a website using the assigned button. When you select Launch Program, two choices will appear which requires you to search for a specific app you want to open, or write the address of the website you want to visit.

Multimedia

This option allows you to assign multimedia controls to your Razer device. Listed below are the multimedia controls you can choose from:

- Volume Down - Decreases the audio output.
- Volume Up - Increases the audio output.
- Mute Volume - Mutes the audio.
- Mic Volume Up - Increases the microphone volume.
- Mic Volume Down - Decreases the microphone volume.
- Mute Mic - Mutes the microphone.
- Mute All - Mutes both microphone and audio output.
- Play / Pause - Play, pause, or resume playback of the current media.
- Previous Track - Play the previous media track.
- Next Track - Play the next media track.

Windows 8 Charms

This option enables you to assign the mouse button into a Windows 8 shortcut command. For more information, please visit: <http://windows.microsoft.com/en-us/windows-8/getting-around-tutorial>

Windows Shortcuts

This option allows you to assign the mouse button into a Windows Operating System shortcut command. For more information, please visit: <http://support.microsoft.com/kb/126449>

Text Function

Text Function enables you to type a prewritten text with a touch of a button. Simply write your desired text on the given field and your text will be typed whenever the assigned button is pressed. This function has full Unicode support and you can also insert special symbols from character maps.

Disable

This option renders the assigned key unusable. Use Disable if you do not want to use the mouse button or if it interferes with your gaming.

Performance

The Performance subtab allows you to modify the sensitivity, acceleration, and polling rate.

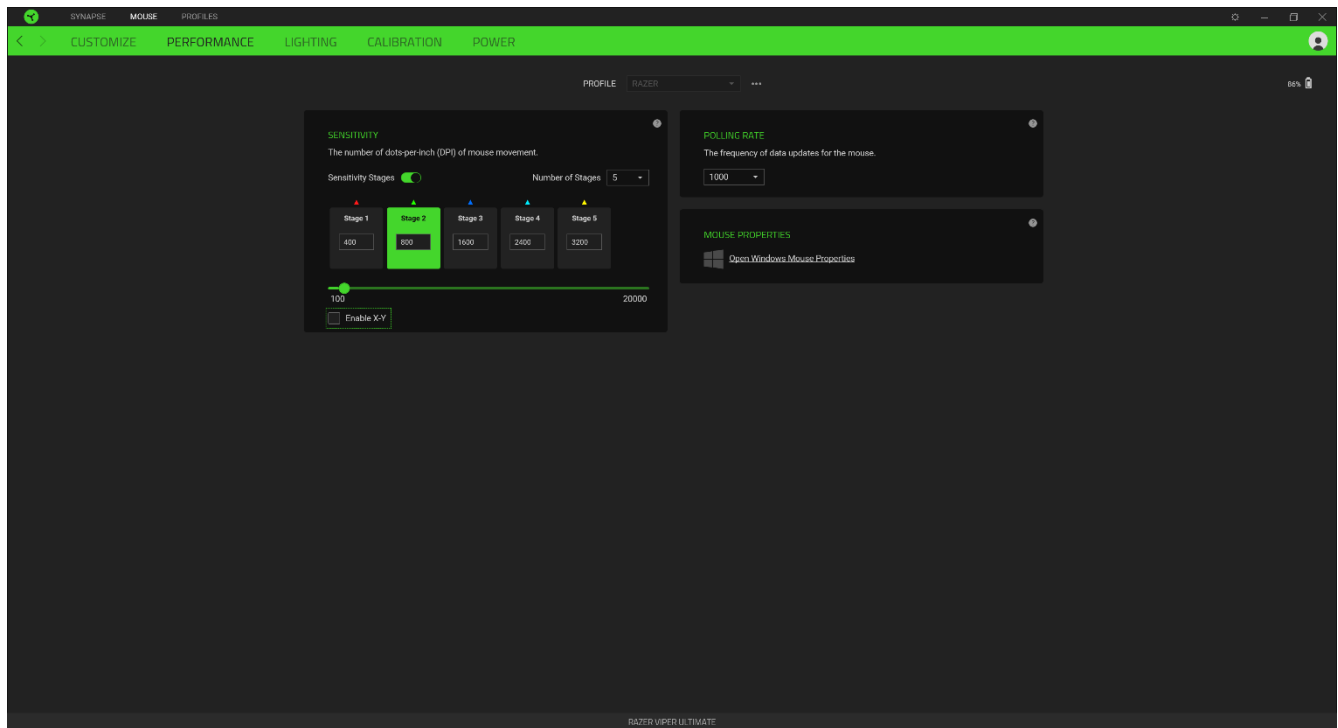

Listed below are the performance options and their descriptions.

Sensitivity

Sensitivity refers to the distance the cursor will travel based on how far the mouse moved. The higher the DPI, the farther the cursor will travel given the same distance of mouse movement.

Enable X-Y Sensitivity

By default, the X-axis (horizontal) and Y-axis (vertical) use the same sensitivity values. However, you may set different sensitivity values to each of the axes by selecting the Enable X-Y Sensitivity option.

Sensitivity Stages

A sensitivity stage is a preset sensitivity value. You can create up to 5 different sensitivity stages which you can cycle through using the sensitivity stage up/down buttons. You may use the Enable X-Y Sensitivity concurrently with this option.

Polling Rate

The higher the polling rate, the more often the computer receives information about the status of your mouse, thus increasing the mouse pointer's reaction time. You can switch between 125Hz

(8ms), 500Hz (2ms) and 1000Hz (1ms) by selecting your desired polling rate on the dropdown menu.

Mouse Properties

From here, you can access the Windows Mouse Properties where you modify operating system settings that can directly affect your Razer Viper Ultimate.

Lighting

The Lighting subtab enables you to modify your Razer device's light settings.

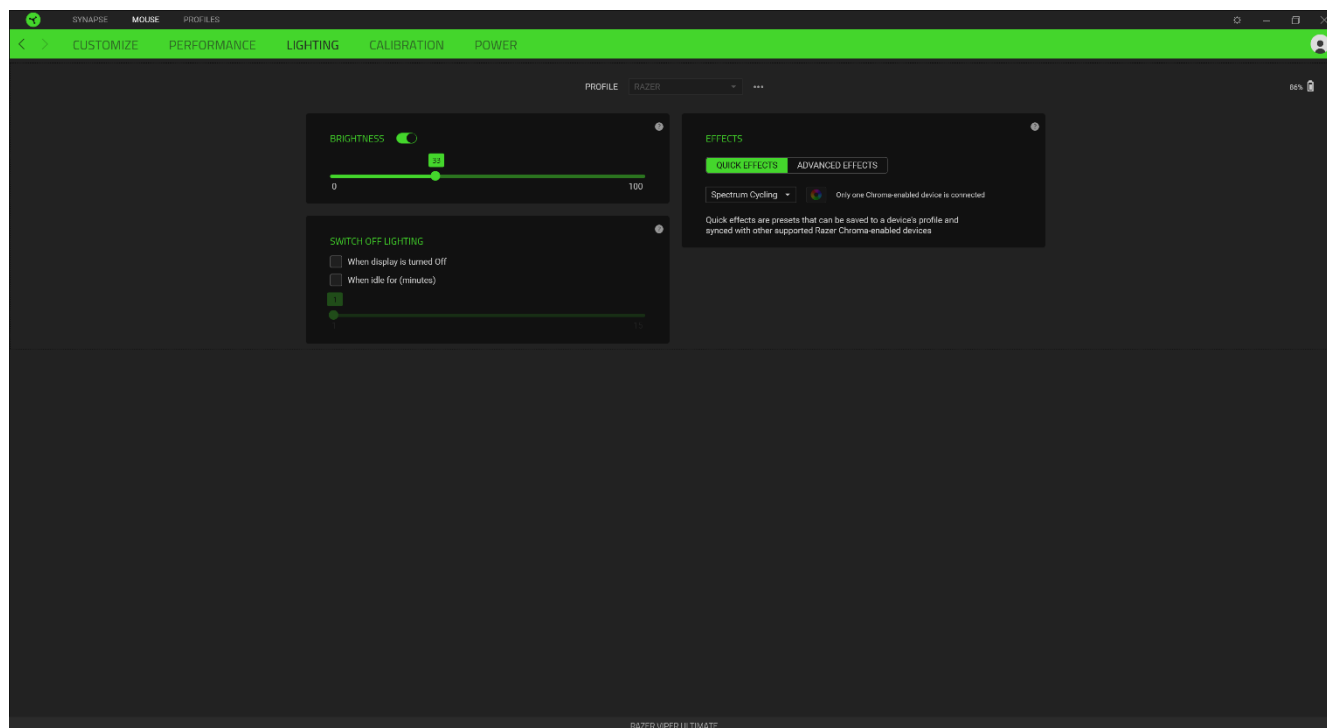

Brightness

You can turn off your Razer device's lighting by toggling the Brightness option or increase/decrease the luminance using the slider.





Switch Off Lighting

This is a power saving tool which allows you to disable your device's lighting in response to your system's display turning off and/or automatically power down when your Razer Viper Ultimate has been idle for a set amount of time.

Quick Effects

A number of quick effects can be selected and applied to your mouse's lighting, as listed here:

Name	Description	How to set up
------	-------------	---------------

	Audio Meter	The LEDs will light up according to the audio level with a default spectrum of colors	Select a Color Boost level
	Breathing	The lighting fades in and out of the selected color(s)	Select up to 2 colors or randomize
	Reactive	The LEDs will light up when you click any of the mouse buttons	Select the color and the length of time for the LED to remain lit
	Spectrum Cycling	The LEDs will cycle between 16.8 million colors indefinitely	No further customization required
	Static	The LEDs will remain lit in the selected color	Select a color

If you have other supported Razer Chroma-enabled devices, you can synchronize their quick effects with your Razer device by clicking the Chroma Sync button ().

Advanced Effects

The Advanced Effects option allows you to choose a Chroma Effect you want to use on your Razer Chroma-enabled peripheral. To start making your own Chroma Effect, simply press the Chroma Studio button (). [Click here to learn more about the Chroma Studio](#)

Calibration

The Calibration subtab allows you to optimize your Razer Precision Sensor to any surface for better tracking.

Smart Tracking

Smart Tracking enables you to set the distance at which the sensor stops tracking when it is lifted from its surface to avoid unwanted cursor movement. You may set different values to the lift-off and landing distances by selecting the Enable Asymmetric Cut-Off.

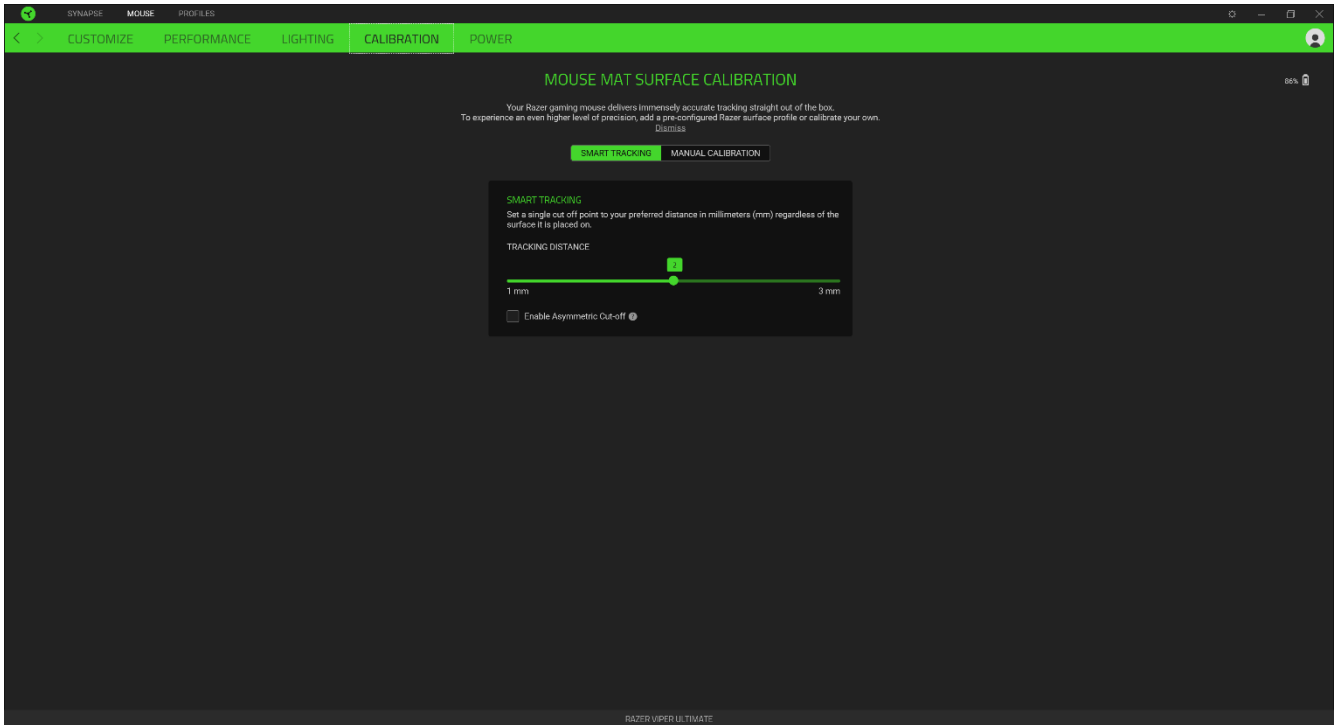

Manual Calibration

To use this feature, you must click the Add A Surface option where you can select from a comprehensive list of Razer mouse mats or add your own mouse mat.

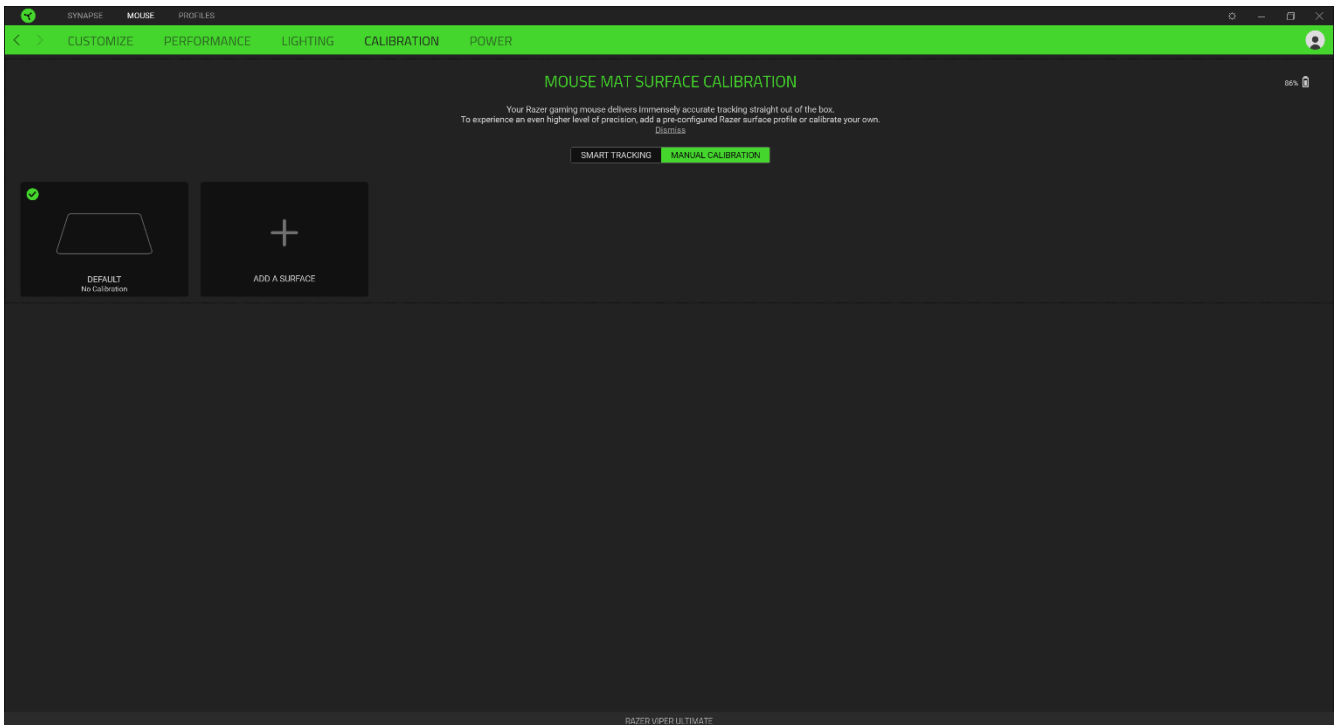

Power

The Power subtab allows you to manage your device's energy consumption when running on batteries. You can also set your device to enter sleep mode when it has been idle for a certain amount of time.

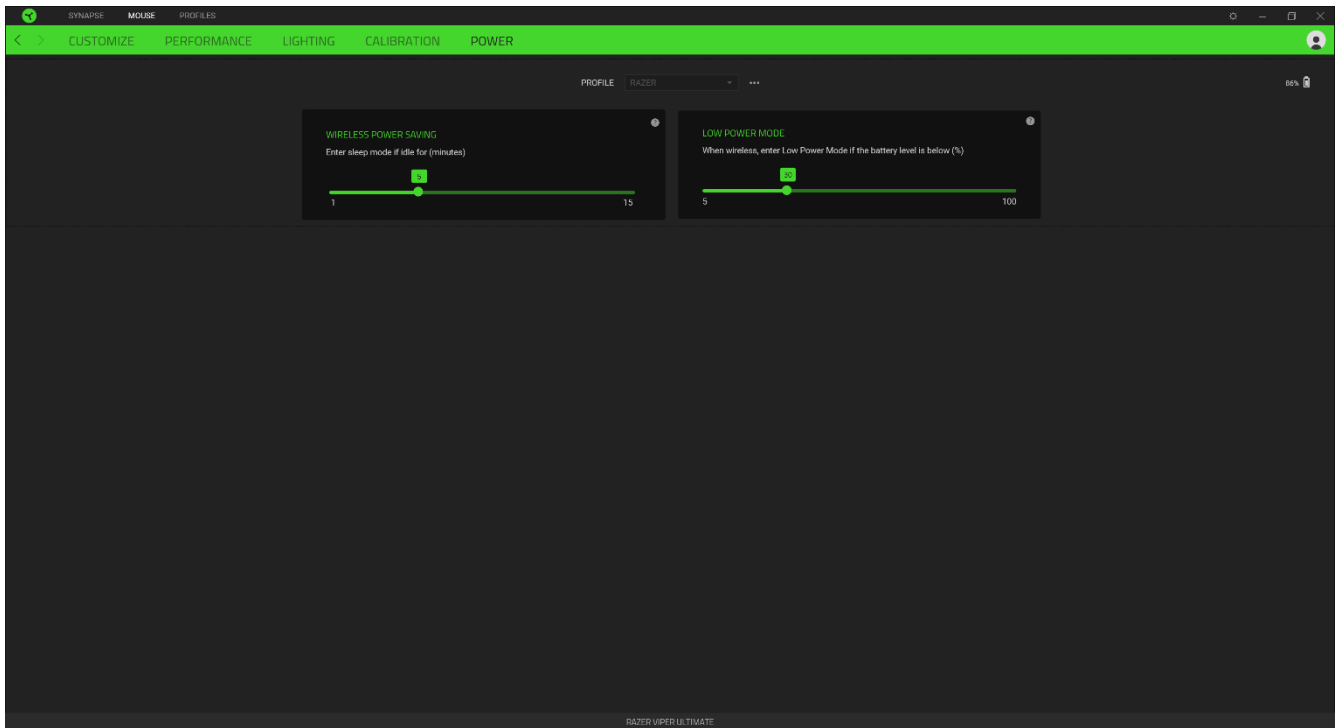

PROFILES TAB

The Profiles tab is a convenient way of managing all your profiles and linking them to your games and applications.

Devices

View which Razer device is using a specific profile using the Devices subtab. To create a new profile within the selected device, simply click the add button (+). To rename, duplicate, or delete a profile, simply press the Miscellaneous button (●●●). Each profile can be set to automatically activate when you run an application using the Link Games option.

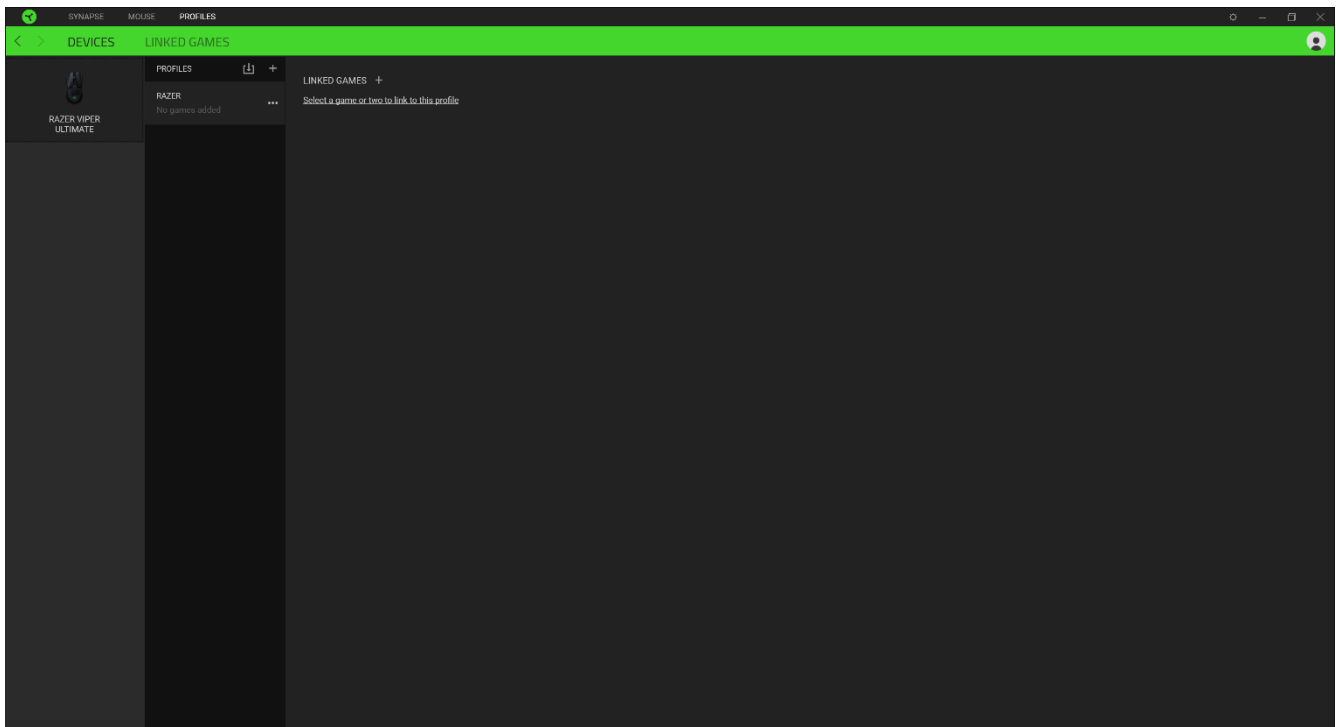

Linked Games

The Linked Games subtab gives you the flexibility to add games, view peripherals that are linked to games, or search for added games. You can also sort games based on alphabetical order, last played, or most played. Added games will still be listed here even if it is not linked to a Razer device.

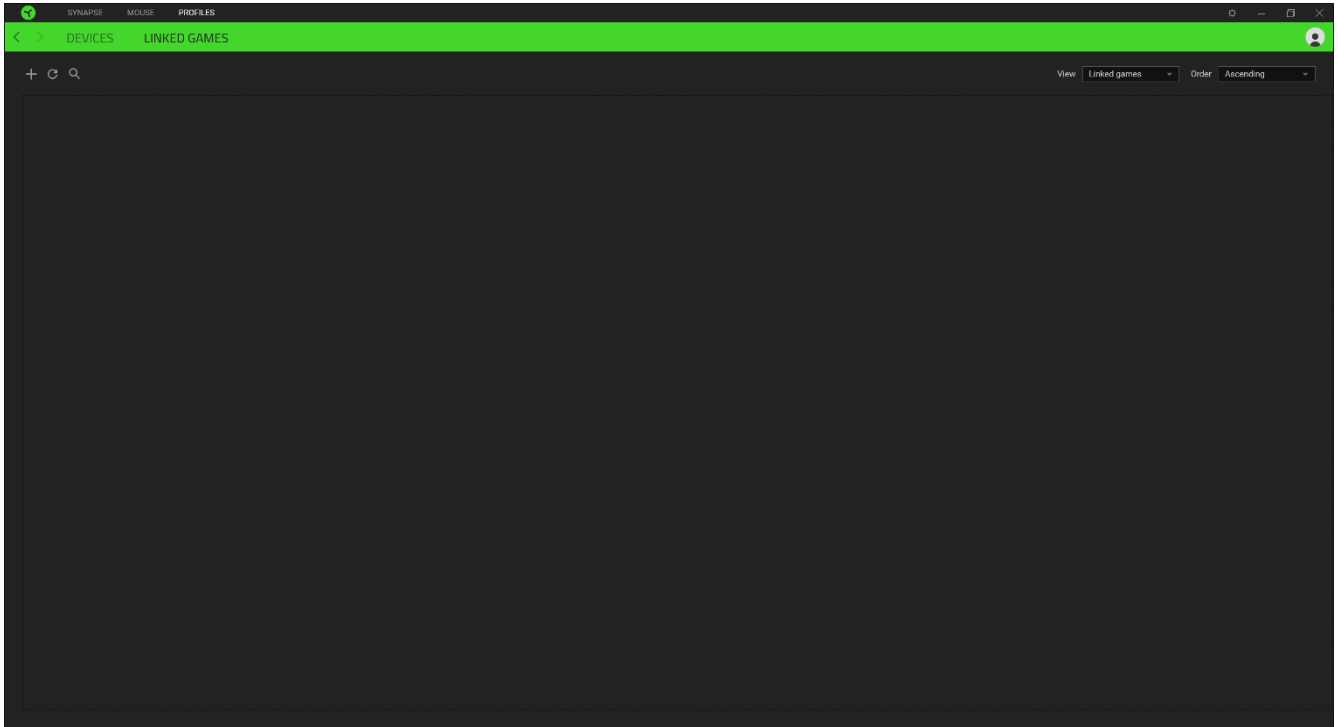

SETTINGS WINDOW

The Settings window, accessible by clicking the (⚙️) button on Razer Synapse 3, enables you to configure the startup behavior, change language, view your Razer device's master guide, or perform factory reset on any connected Razer device.

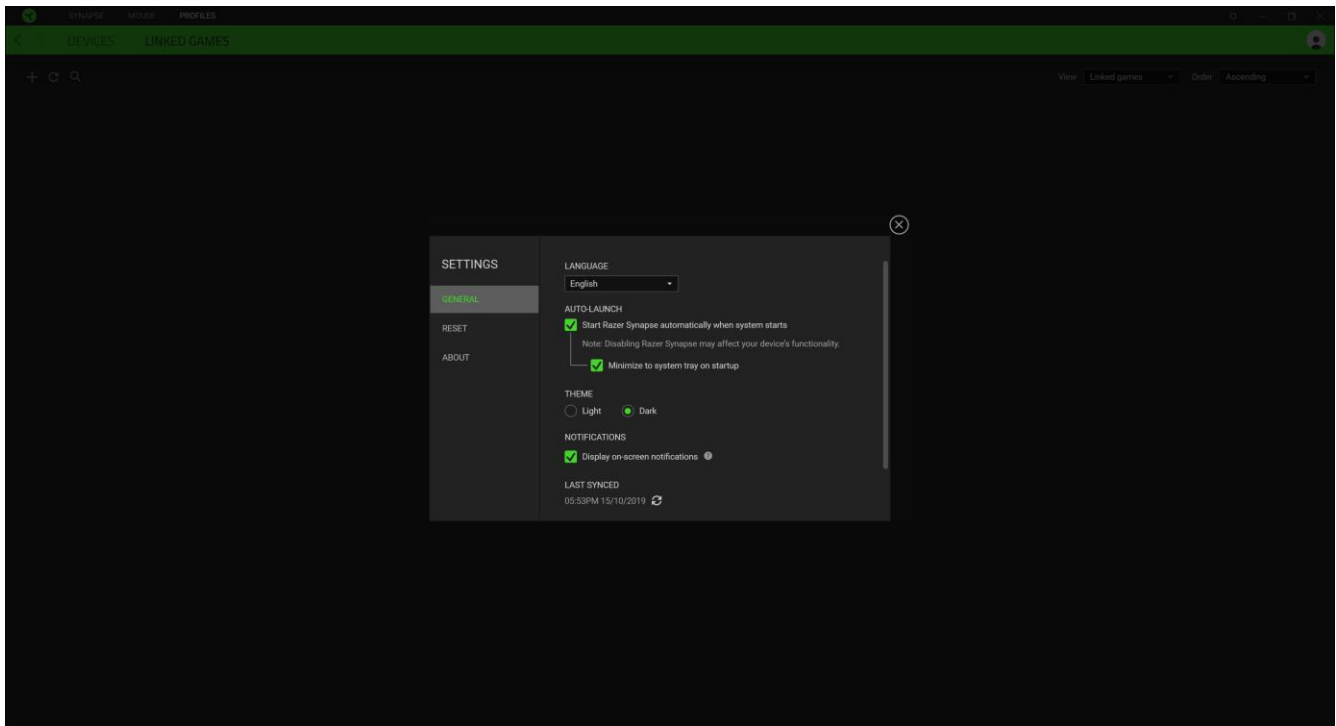

General tab

The default tab of the Settings window, The General tab enables you to change the software's display language and start-up behavior, or view the master guide of all connected Razer devices.

Reset tab

The Reset tab allows you to perform a factory reset on all connected Razer devices with on-board memory. All profiles stored on the selected device's on-board memory will be erased.

Note: Performing a factory reset on devices without on-board memory will only create a new profile for your device on Razer Synapse 3 using the default settings.

About tab

The About tab displays brief software information, its copyright statement, and also provides relevant links for its terms of use. You may also use this tab to check for software updates, or as a quick access to Razer's social communities.

6. SAFETY AND MAINTENANCE

SAFETY GUIDELINES

In order to achieve maximum safety while using your Razer Viper Ultimate, we suggest that you adopt the following guidelines:

Should you have trouble operating the device properly and troubleshooting does not work, unplug the device and contact the Razer hotline or go to support.razer.com for support. Do not attempt to service or fix the device yourself at any time.

Do not take apart the device (doing so will void your warranty) and do not attempt to operate it under abnormal current loads.

Keep the device away from liquid, humidity or moisture. Operate the device only within the specific temperature range of 0°C (32°F) to 40°C (104°F). Should the temperature exceed this range, unplug and/or switch off the device in order to let the temperature stabilize to an optimal level.

COMFORT

Research has shown that long periods of repetitive motion, improper positioning of your computer peripherals, incorrect body position, and poor habits may be associated with physical discomfort and injury to nerves, tendons, and muscles. Below are some guidelines to avoid injury and ensure optimum comfort while using your Razer Viper Ultimate.

- Position your keyboard and monitor directly in front of you with your mouse next to it. Place your elbows next to your side, not too far away and your keyboard within easy reach.
- Adjust the height of your chair and table so that the keyboard and mouse are at or below elbow-height.
- Keep your feet well supported, posture straight and your shoulders relaxed.
- During gameplay, relax your wrist and keep it straight. If you do the same tasks with your hands repeatedly, try not to bend, extend or twist your hands for long periods.
- Do not rest your wrists on hard surfaces for long periods. Use a wrist rest to support your wrist while gaming.
- Customize the keys on your keyboard to suit your style of gaming in order to minimize repetitive or awkward motions while gaming.
- Do not sit in the same position all day. Get up, step away from your desk and do exercises to stretch your arms, shoulders, neck and legs.

If you should experience any physical discomfort while using your mouse, such as pain, numbness, or tingling in your hands, wrists, elbows, shoulders, neck or back, please consult a qualified medical doctor immediately.

MAINTENANCE AND USE

The Razer Viper Ultimate requires minimum maintenance to keep it in optimum condition. Once a month we recommend you unplug the device from the computer and clean it using a soft cloth or cotton swab to prevent dirt buildup. Do not use soap or harsh cleaning agents.

To get the ultimate experience in movement and control, we highly recommend a premium mouse mat from Razer. Some surfaces will cause undue wear on the feet requiring constant care and eventual replacement.

Do note that the sensor of the Razer Viper Ultimate is 'tuned' or optimized especially for the Razer mouse mats. This means that the sensor has been tested extensively to confirm that the Razer Viper Ultimate reads and tracks best on Razer mouse mats.

7. LEGALESE

COPYRIGHT AND INTELLECTUAL PROPERTY INFORMATION

©2019 Razer Inc. All rights reserved. Razer, the triple-headed snake logo, Razer logo, “For Gamers. By Gamers.”, and “Powered by Razer Chroma” logo are trademarks or registered trademarks of Razer Inc. and/or affiliated companies in the United States or other countries. All other trademarks and trade names are the property of their respective owners and other company and product names mentioned herein may be trademarks of their respective companies.

Windows and the Windows logo are trademarks of the Microsoft group of companies.

Razer Inc. (“Razer”) may have copyright, trademarks, trade secrets, patents, patent applications, or other intellectual property rights (whether registered or unregistered) concerning the product in this guide. Furnishing of this guide does not give you a license to any such copyright, trademark, patent or other intellectual property right. The Razer Viper Ultimate (the “Product”) may differ from pictures whether on packaging or otherwise. Razer assumes no responsibility for such differences or for any errors that may appear. Information contained herein is subject to change without notice.

LIMITED PRODUCT WARRANTY

For the latest and current terms of the Limited Product Warranty, please visit [razer.com/warranty](https://www.razer.com/warranty).

LIMITATION OF LIABILITY

Razer shall in no event be liable for any lost profits, loss of information or data, special, incidental, indirect, punitive or consequential or incidental damages, arising in any way out of distribution of, sale of, resale of, use of, or inability to use the Product. In no event shall Razer’s liability exceed the retail purchase price of the Product.

GENERAL

These terms shall be governed by and construed under the laws of the jurisdiction in which the Product was purchased. If any term herein is held to be invalid or unenforceable, then such term (in so far as it is invalid or unenforceable) shall be given no effect and deemed to be excluded without invalidating any of the remaining terms. Razer reserves the right to amend any term at any time without notice.