

Precision 7760

Service Manual



Notes, cautions, and warnings

 **NOTE:** A NOTE indicates important information that helps you make better use of your product.

 **CAUTION:** A CAUTION indicates either potential damage to hardware or loss of data and tells you how to avoid the problem.

 **WARNING:** A WARNING indicates a potential for property damage, personal injury, or death.

Chapter 1: Working inside your computer	7
Safety instructions	7
Before working inside your computer	7
Safety precautions	8
Electrostatic discharge—ESD protection	8
ESD field service kit	9
Transporting sensitive components	10
After working inside your computer	10
Chapter 2: Removing and installing components	11
Recommended tools	11
Screw list	12
Major components of Precision 7760	13
SD card	15
Removing SD card	15
Installing SD card	15
Secondary M.2 solid-state drive	16
Removing the secondary M.2 Solid-state drive	16
Installing the secondary M.2 SSD module	18
Base cover	21
Removing the base cover	21
Installing the base cover	24
Battery	26
Lithium-ion battery precautions	26
Removing the battery	27
Installing the battery	28
Solid State Drive	30
Removing the primary M.2 Solid-state drive	30
Installing the primary M.2 SSD module	31
Secondary memory module	33
Removing the secondary memory module	33
Installing the secondary memory module	33
SIM card	34
Removing the SIM card	34
Installing the SIM card	35
WLAN card	36
Removing the WLAN card	36
Installing the WLAN card	37
WWAN card	39
Removing the WWAN card	39
Installing the WWAN card	39
Keyboard lattice	40
Removing the keyboard lattice	40
Installing the keyboard lattice	41

Keyboard.....	42
Removing the keyboard.....	42
Installing the keyboard.....	43
Primary memory module.....	45
Removing the primary memory module.....	45
Installing the primary memory module.....	46
Inner frame.....	47
Removing the inner frame.....	47
Installing the inner frame.....	49
Smart-card reader.....	51
Removing the smart-card reader.....	51
Installing the smart-card reader.....	51
Touchpad button.....	52
Removing the Touchpad buttons.....	52
Installing the Touchpad buttons.....	53
SD card reader.....	54
Removing SD card reader.....	54
Installing SD card reader.....	55
Heat sink	56
Removing the heat-sink assembly.....	56
Installing the heat-sink assembly.....	58
Power button board.....	59
Removing the power button board.....	59
Installing the power button board.....	60
Power button board with fingerprint reader.....	61
Removing the power button board assembly with fingerprint reader.....	61
Installing the power button board assembly with fingerprint reader.....	62
Power button.....	63
Removing the power button.....	63
Installing the power button.....	64
Power button assembly with fingerprint reader.....	65
Removing the power button board assembly with fingerprint reader.....	65
Installing the power button assembly with fingerprint reader.....	66
GPU power cable.....	67
Removing the GPU power cable.....	67
Installing the GPU power cable.....	68
System board.....	69
Removing the system board.....	69
Installing the system board.....	73
Power-adaptor port.....	76
Removing the power-adaptor port.....	76
Installing the power-adaptor port.....	77
GPU card.....	78
Removing the GPU card.....	78
Installing the GPU card.....	79
Speaker.....	80
Removing the speaker.....	80
Installing the speaker.....	81
Middle cap.....	83
Removing the middle cap.....	83

Installing the middle cap.....	84
Display assembly.....	86
Removing the display assembly.....	86
Installing the display assembly.....	88
Palm rest.....	90
Removing the palmrest.....	90
Installing the palmrest.....	91
Display bezel.....	93
Removing the display bezel (non-touch).....	93
Installing the display bezel (non-touch).....	94
Display panel.....	96
Removing the display panel (non-touch).....	96
Installing the display panel (non-touch).....	99
Display hinges.....	102
Removing the display hinge.....	102
Installing the display hinge (non-touch).....	103
Camera shutter cap.....	104
Removing camera shutter cap.....	104
Installing camera shutter cap.....	105
Camera.....	106
Removing the camera (non-touch).....	106
Installing the camera.....	107
P-sensor board.....	109
Removing the P-sensor board.....	109
Installing the P-sensor board.....	110
Display cable.....	112
Removing the display cable.....	112
Installing the display cable.....	113
Display back cover.....	115
Replacing the display back cover.....	115

Chapter 3: Drivers and downloads.....117

Chapter 4: BIOS setup..... 118

BIOS overview.....	118
Entering BIOS setup program.....	118
Navigation keys.....	118
Boot Sequence.....	119
BIOS setup options.....	119
Updating the BIOS in Windows	125
Updating BIOS on systems with BitLocker enabled.....	126
Updating your system BIOS using a USB flash drive.....	126
Updating the Dell BIOS in Linux and Ubuntu environments.....	127
One time boot menu.....	127
Flashing the BIOS from the F12 One-Time boot menu.....	127
System and setup password.....	128
Assigning a system setup password.....	128
Deleting or changing an existing system setup password.....	129
Clearing BIOS (System Setup) and System passwords.....	129

Chapter 5: Troubleshooting.....	130
Built-in self-test (BIST).....	130
M-BIST.....	130
M-BIST.....	131
LCD Power rail test (L-BIST).....	131
LCD Built-in Self Test (BIST).....	131
LCD Built-in Self Test (BIST).....	132
Dell SupportAssist Pre-boot System Performance Check diagnostics.....	132
Running the SupportAssist Pre-Boot System Performance Check.....	132
System-diagnostic lights.....	133
Recovering the operating system.....	134
Backup media and recovery options.....	135
Real Time Clock—RTC reset.....	135
Updating the BIOS in Windows environment.....	135
Updating the BIOS using the USB drive in Windows environment.....	136
WiFi power cycle.....	136
Drain residual flea power (perform hard reset).....	136
 Chapter 6: Getting help and contacting Dell.....	 138

Working inside your computer

Topics:

- [Safety instructions](#)

Safety instructions

Use the following safety guidelines to protect your computer from potential damage and to ensure your personal safety. Unless otherwise noted, each procedure included in this document assumes that you have read the safety information that shipped with your computer.

 **WARNING:** Before working inside your computer, read the safety information that is shipped with your computer. For more safety best practices, see the Regulatory Compliance home page at www.dell.com/regulatory_compliance.

 **WARNING:** Disconnect your computer from all power sources before opening the computer cover or panels. After you finish working inside the computer, replace all covers, panels, and screws before connecting your computer to an electrical outlet.

 **CAUTION:** To avoid damaging the computer, ensure that the work surface is flat, dry, and clean.

 **CAUTION:** To avoid damaging the components and cards, handle them by their edges, and avoid touching the pins and the contacts.

 **CAUTION:** You should only perform troubleshooting and repairs as authorized or directed by the Dell technical assistance team. Damage due to servicing that is not authorized by Dell is not covered by your warranty. See the safety instructions that is shipped with the product or at www.dell.com/regulatory_compliance.

 **CAUTION:** Before touching anything inside your computer, ground yourself by touching an unpainted metal surface, such as the metal at the back of the computer. While you work, periodically touch an unpainted metal surface to dissipate static electricity which could harm internal components.

 **CAUTION:** When you disconnect a cable, pull it by its connector or its pull tab, not the cable itself. Some cables have connectors with locking tabs or thumbscrews that you must disengage before disconnecting the cable. When disconnecting cables, keep them evenly aligned to avoid bending the connector pins. When connecting cables, ensure that the ports and the connectors are correctly oriented and aligned.

 **CAUTION:** Press and eject any installed card from the media-card reader.

 **CAUTION:** Exercise caution when handling Lithium-ion batteries in laptops. Swollen batteries should not be used and should be replaced and disposed properly.

 **NOTE:** The color of your computer and certain components may appear differently than shown in this document.

Before working inside your computer

Steps

1. Save and close all open files and exit all open applications.
2. Shut down your computer. Click **Start** >  **Power** > **Shut down**.

 **NOTE:** If you are using a different operating system, see the documentation of your operating system for shut-down instructions.

3. Disconnect your computer and all attached devices from their electrical outlets.
4. Disconnect all attached network devices and peripherals, such as keyboard, mouse, and monitor from your computer.
5. Remove any media card and optical disc from your computer, if applicable.
6. After the computer is unplugged, press and hold the power button for 5 seconds to ground the system board.

 **CAUTION:** Place the computer on a flat, soft, and clean surface to avoid scratches on the display.

7. Place the computer face down.

Safety precautions

The safety precautions chapter details the primary steps to be taken before performing any disassembly instructions.

Observe the following safety precautions before you perform any installation or break/fix procedures involving disassembly or reassembly:

- Turn off the system and all attached peripherals.
- Disconnect the system and all attached peripherals from AC power.
- Disconnect all network cables, telephone, and telecommunications lines from the system.
- Use an ESD field service kit when working inside any tablet/notebook to avoid electrostatic discharge (ESD) damage.
- After removing any system component, carefully place the removed component on an anti-static mat.
- Wear shoes with non-conductive rubber soles to reduce the chance of getting electrocuted.

Standby power

Dell products with standby power must be unplugged before you open the case. Systems that incorporate standby power are essentially powered while turned off. The internal power enables the system to be remotely turned on (wake on LAN) and suspended into a sleep mode and has other advanced power management features.

Unplugging, pressing and holding the power button for 15 seconds should discharge residual power in the system board.

Bonding

Bonding is a method for connecting two or more grounding conductors to the same electrical potential. This is done through the use of a field service electrostatic discharge (ESD) kit. When connecting a bonding wire, ensure that it is connected to bare metal and never to a painted or non-metal surface. The wrist strap should be secure and in full contact with your skin, and ensure that you remove all jewelry such as watches, bracelets, or rings prior to bonding yourself and the equipment.

Electrostatic discharge—ESD protection

ESD is a major concern when you handle electronic components, especially sensitive components such as expansion cards, processors, memory DIMMs, and system boards. Very slight charges can damage circuits in ways that may not be obvious, such as intermittent problems or a shortened product life span. As the industry pushes for lower power requirements and increased density, ESD protection is an increasing concern.

Due to the increased density of semiconductors used in recent Dell products, the sensitivity to static damage is now higher than in previous Dell products. For this reason, some previously approved methods of handling parts are no longer applicable.

Two recognized types of ESD damage are catastrophic and intermittent failures.

- **Catastrophic** – Catastrophic failures represent approximately 20 percent of ESD-related failures. The damage causes an immediate and complete loss of device functionality. An example of catastrophic failure is a memory DIMM that has received a static shock and immediately generates a "No POST/No Video" symptom with a beep code emitted for missing or nonfunctional memory.
- **Intermittent** – Intermittent failures represent approximately 80 percent of ESD-related failures. The high rate of intermittent failures means that most of the time when damage occurs, it is not immediately recognizable. The DIMM receives a static shock, but the tracing is merely weakened and does not immediately produce outward symptoms related to

the damage. The weakened trace may take weeks or months to melt, and in the meantime may cause degradation of memory integrity, intermittent memory errors, etc.

The more difficult type of damage to recognize and troubleshoot is the intermittent (also called latent or "walking wounded") failure.

Perform the following steps to prevent ESD damage:

- Use a wired ESD wrist strap that is properly grounded. The use of wireless anti-static straps is no longer allowed; they do not provide adequate protection. Touching the chassis before handling parts does not ensure adequate ESD protection on parts with increased sensitivity to ESD damage.
- Handle all static-sensitive components in a static-safe area. If possible, use anti-static floor pads and workbench pads.
- When unpacking a static-sensitive component from its shipping carton, do not remove the component from the anti-static packing material until you are ready to install the component. Before unwrapping the anti-static packaging, ensure that you discharge static electricity from your body.
- Before transporting a static-sensitive component, place it in an anti-static container or packaging.

ESD field service kit

The unmonitored Field Service kit is the most commonly used service kit. Each Field Service kit includes three main components: anti-static mat, wrist strap, and bonding wire.

Components of an ESD field service kit

The components of an ESD field service kit are:

- **Anti-Static Mat** – The anti-static mat is dissipative and parts can be placed on it during service procedures. When using an anti-static mat, your wrist strap should be snug and the bonding wire should be connected to the mat and to any bare metal on the system being worked on. Once deployed properly, service parts can be removed from the ESD bag and placed directly on the mat. ESD-sensitive items are safe in your hand, on the ESD mat, in the system, or inside a bag.
- **Wrist Strap and Bonding Wire** – The wrist strap and bonding wire can be either directly connected between your wrist and bare metal on the hardware if the ESD mat is not required, or connected to the anti-static mat to protect hardware that is temporarily placed on the mat. The physical connection of the wrist strap and bonding wire between your skin, the ESD mat, and the hardware is known as bonding. Use only Field Service kits with a wrist strap, mat, and bonding wire. Never use wireless wrist straps. Always be aware that the internal wires of a wrist strap are prone to damage from normal wear and tear, and must be checked regularly with a wrist strap tester in order to avoid accidental ESD hardware damage. It is recommended to test the wrist strap and bonding wire at least once per week.
- **ESD Wrist Strap Tester** – The wires inside of an ESD strap are prone to damage over time. When using an unmonitored kit, it is a best practice to regularly test the strap prior to each service call, and at a minimum, test once per week. A wrist strap tester is the best method for doing this test. If you do not have your own wrist strap tester, check with your regional office to find out if they have one. To perform the test, plug the wrist-strap's bonding-wire into the tester while it is strapped to your wrist and push the button to test. A green LED is lit if the test is successful; a red LED is lit and an alarm sounds if the test fails.
- **Insulator Elements** – It is critical to keep ESD sensitive devices, such as plastic heat sink casings, away from internal parts that are insulators and often highly charged.
- **Working Environment** – Before deploying the ESD Field Service kit, assess the situation at the customer location. For example, deploying the kit for a server environment is different than for a desktop or portable environment. Servers are typically installed in a rack within a data center; desktops or portables are typically placed on office desks or cubicles. Always look for a large open flat work area that is free of clutter and large enough to deploy the ESD kit with additional space to accommodate the type of system that is being repaired. The workspace should also be free of insulators that can cause an ESD event. On the work area, insulators such as Styrofoam and other plastics should always be moved at least 12 inches or 30 centimeters away from sensitive parts before physically handling any hardware components.
- **ESD Packaging** – All ESD-sensitive devices must be shipped and received in static-safe packaging. Metal, static-shielded bags are preferred. However, you should always return the damaged part using the same ESD bag and packaging that the new part arrived in. The ESD bag should be folded over and taped shut and all the same foam packing material should be used in the original box that the new part arrived in. ESD-sensitive devices should be removed from packaging only at an ESD-protected work surface, and parts should never be placed on top of the ESD bag because only the inside of the bag is shielded. Always place parts in your hand, on the ESD mat, in the system, or inside an anti-static bag.
- **Transporting Sensitive Components** – When transporting ESD sensitive components such as replacement parts or parts to be returned to Dell, it is critical to place these parts in anti-static bags for safe transport.

ESD protection summary

It is recommended that all field service technicians use the traditional wired ESD grounding wrist strap and protective anti-static mat at all times when servicing Dell products. In addition, it is critical that technicians keep sensitive parts separate from all insulator parts while performing service and that they use anti-static bags for transporting sensitive components.

Transporting sensitive components

When transporting ESD sensitive components such as replacement parts or parts to be returned to Dell, it is critical to place these parts in anti-static bags for safe transport.

After working inside your computer

About this task

 **NOTE:** Leaving stray or loose screws inside your computer may severely damage your computer.

Steps

1. Replace all screws and ensure that no stray screws remain inside your computer.
2. Connect any external devices, peripherals, or cables you removed before working on your computer.
3. Replace any media cards, discs, or any other parts that you removed before working on your computer.
4. Connect your computer and all attached devices to their electrical outlets.
5. Turn on your computer.

Removing and installing components

 **NOTE:** The images in this document may differ from your computer depending on the configuration you ordered.

Topics:

- Recommended tools
- Screw list
- Major components of Precision 7760
- SD card
- Secondary M.2 solid-state drive
- Base cover
- Battery
- Solid State Drive
- Secondary memory module
- SIM card
- WLAN card
- WWAN card
- Keyboard lattice
- Keyboard
- Primary memory module
- Inner frame
- Smart-card reader
- Touchpad button
- SD card reader
- Heat sink
- Power button board
- Power button board with fingerprint reader
- Power button
- Power button assembly with fingerprint reader
- GPU power cable
- System board
- Power-adaptor port
- GPU card
- Speaker
- Middle cap
- Display assembly
- Palm rest
- Display bezel
- Display panel
- Display hinges
- Camera shutter cap
- Camera
- P-sensor board
- Display cable
- Display back cover

Recommended tools

The procedures in this document may require the following tools:

- Phillips screwdriver #0
- Phillips screwdriver #1
- Plastic scribe

Screw list

NOTE: When removing screws from a component, it is recommended to note the screw type, the quantity of screws, and then place them in a screw storage box. This is to ensure that the correct number of screws and correct screw type is restored when the component is replaced.

NOTE: Some computers have magnetic surfaces. Ensure that the screws are not left attached to such surfaces when replacing a component.

NOTE: Screw color may vary with the configuration ordered.

Table 1. Screw list



















Component	Screw type	Quantity	Screw image
Base cover	Captive screws	8	
Battery	M2x5	3	
M.2 2280 PCIe 4 secondary Solid-state drive (slot 6)	M2x3	2	
M.2 2230 primary Solid-state drive (slot 3, slot 4 and/or slot 5)	M2x3 M2x2	2 1	 
M.2 2280 primary Solid-state drive (slot 3, slot 4 and slot 5)	M2x3	2	
Keyboard	M2x2	6	
WWAN	M2x3	1	
WLAN	Captive screw	1	
Memory shield	M2x3	1	
Power-adaptor cable bracket	M2x3	1	
Power button board	M2x3	2	
Power button assembly with fingerprint reader cable bracket	M2.5x2.5	1	
Inner frame	M2x3	10	
Smart card reader	M2x2.5	2	
Touchpad buttons	M2x2.5	2	
SD card reader	M2.5x2.5	1	

Table 1. Screw list (continued)

Component	Screw type	Quantity	Screw image
Power button	M2x3	2	
Power button assembly with fingerprint reader	M2x3	2	
Darwin cable bracket	M2x3	1	
Display cable bracket	M2x5	1	
System board	M2x5	3	
GPU card	M2x5	4	
Middle cap	M2x3	3	
Hinge screws	M2.5x2.5	8	
Display panel	M2.5x2.5 M2x2.5	2 2	 
Display hinges	M2.5x2.5	8	

Major components of Precision 7760

The following image shows the major components of Precision 7760.

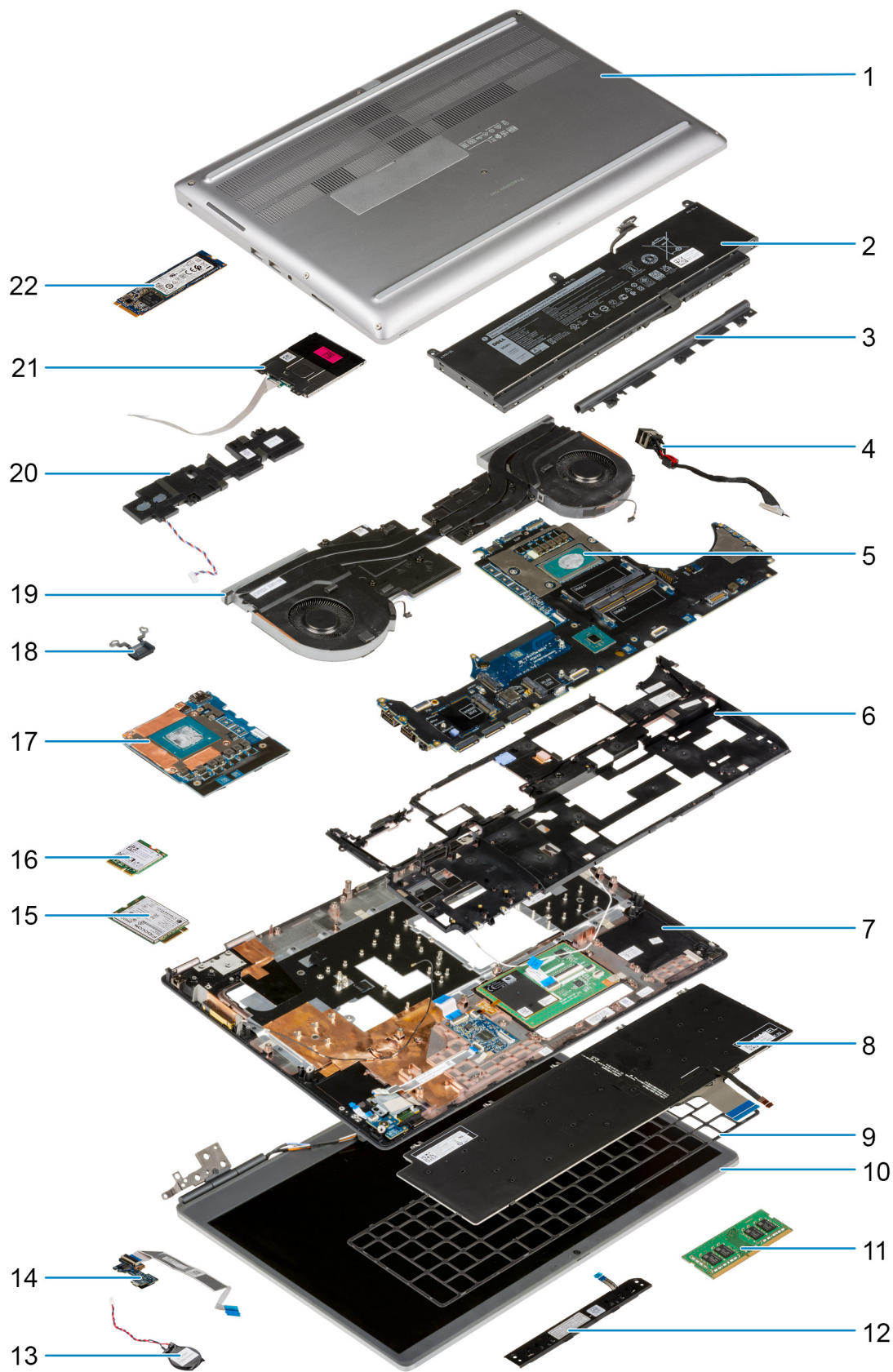

- 1. Base cover
- 3. Middle cap
- 5. System board
- 7. Palmrest

- 2. Battery
- 4. Power-adaptor port
- 6. Inner frame
- 8. Keyboard

- 9. Keyboard lattice
- 11. Memory module
- 13. Coin-cell battery
- 15. WWAN card
- 17. GPU card
- 19. Heat-sink assembly
- 21. Smart card reader module

- 10. Display assembly
- 12. Touchpad button board
- 14. Power button board
- 16. WLAN card
- 18. Power button
- 20. Speaker module
- 22. M.2 SSD

NOTE: Dell provides a list of components and their part numbers for the original system configuration purchased. These parts are available according to warranty coverages purchased by the customer. Contact your Dell sales representative for purchase options.

SD card

Removing SD card

Prerequisites

1. Follow the procedure in [before working inside your computer](#).

About this task

The figure indicates the location of the SD card and provides a visual representation of the removal procedure.



Steps

1. Press the SD card to release it from the computer.
2. Slide the SD card out of the computer.

Installing SD card

Prerequisites

If you are replacing a component, remove the existing component before performing the installation procedure.

About this task

The figure indicates the location of the base cover and provides a visual representation of the installation procedure.



Steps

Slide the SD card into the slot on the computer until it clicks into place.

Next steps

1. Follow the procedure in [after working inside your computer](#).

Secondary M.2 solid-state drive

Removing the secondary M.2 Solid-state drive

Prerequisites

NOTE: For computers shipped with M.2 2280 PCIe Gen4 SSD installed in slot 6.

NOTE: This slot supports only M.2 2280 PCIe Gen4 Solid-state drive and does not support any Optane, SATA, or M.2 2230 Solid-state drive.

1. Follow the procedure in [before working inside your computer](#).
2. Remove the [SD card](#).
3. Remove the [base cover](#).

NOTE: Follow this procedure only if the computer is shipped without SSD door configuration).

About this task

The figure indicates the location of the secondary M.2 SSD and provides a visual representation of the removal procedure.

For computers with SSD door configuration



2x
M2x3

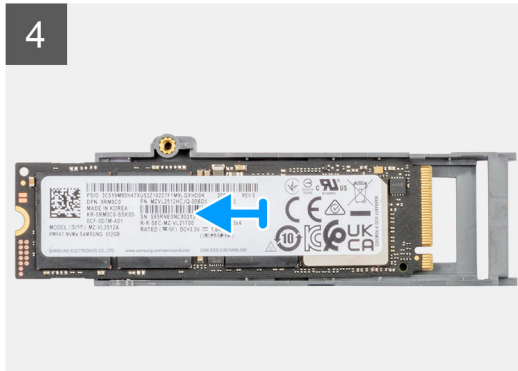
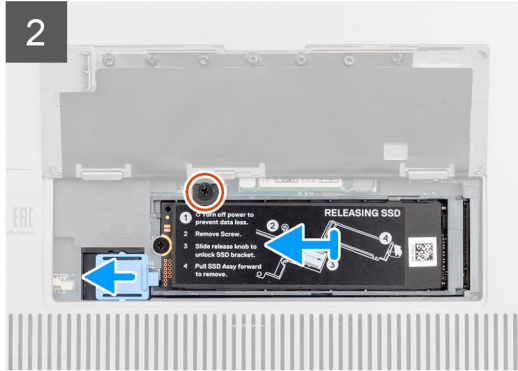
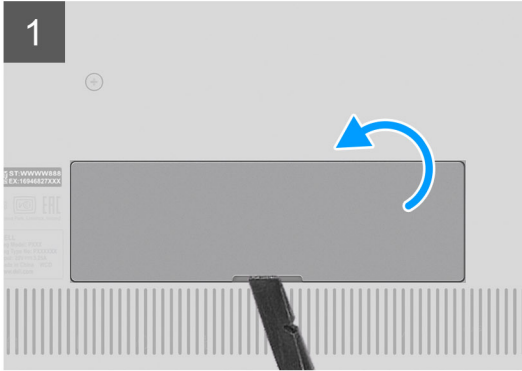
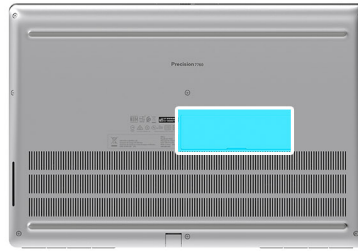

For computers without SSD door configuration



2x
M2x3

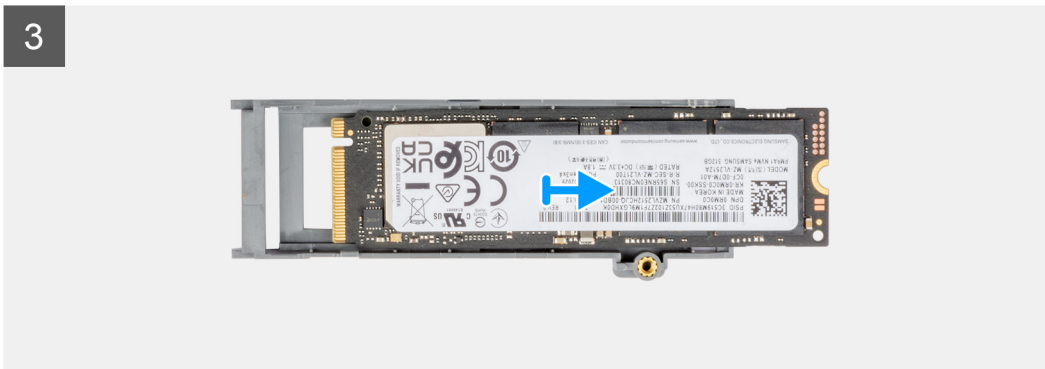
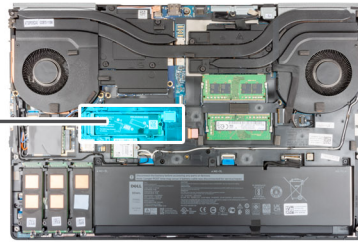

Steps

1. For computers with SSD door configuration:
 - a. Use a plastic scribe to pry open the SSD door from its recess point.
i **NOTE:** The SSD door is attached to the base cover from one side and cannot be detached.
 - b. Follow the procedure from Step 3 to Step 8.
2. For computers without SSD door configuration:
 - a. Follow the procedure from Step 3 to Step 8.
3. Remove the (M2x3) screw that secures the SSD module into its slot on the computer.
4. Slide the SSD release latch to unlock the SSD module.
5. Remove the SSD module from the computer.
6. Remove the (M2x3) screw that secures the SSD thermal plate to the SSD carrier.
7. Carefully tilt at an angle and then slide to remove the SSD thermal plate from the SSD module.
8. Remove the M.2 2280 SSD from the SSD carrier.

Installing the secondary M.2 SSD module

Prerequisites

- i** **NOTE:** For computers shipped with M.2 2280 PCIe Gen4 SSD installed in slot 6.

NOTE: This slot supports only M.2 2280 PCIe Gen4 Solid-state drive and does not support any Optane, SATA, or M.2 2230 Solid-state drive.

If you are replacing a component, remove the existing component before performing the installation procedure.

About this task

The figure indicates the location of the secondary M.2 SSD and provides a visual representation of the installation procedure.

For computers with SSD door configuration



2x
M2x3

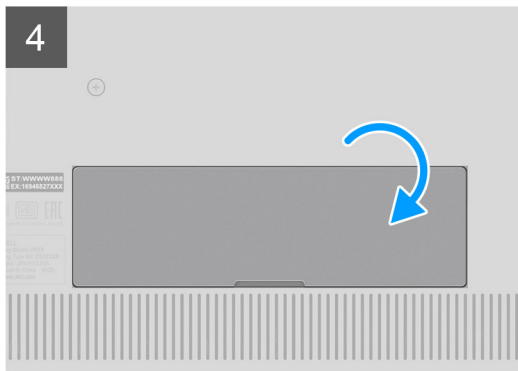
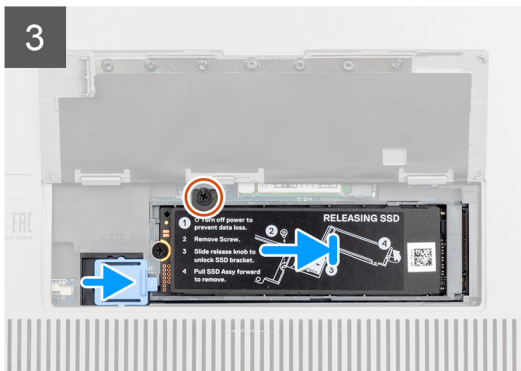
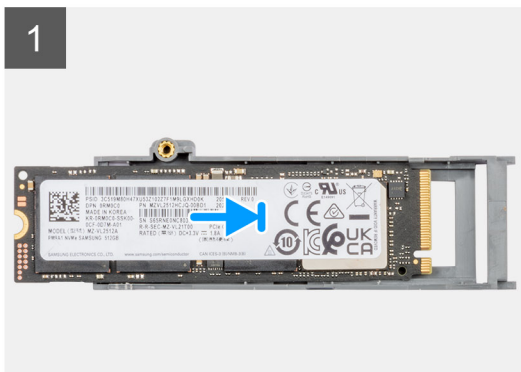
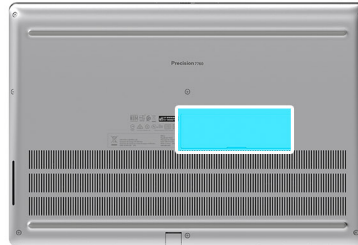

For computers without SSD door configuration



2x
M2x3

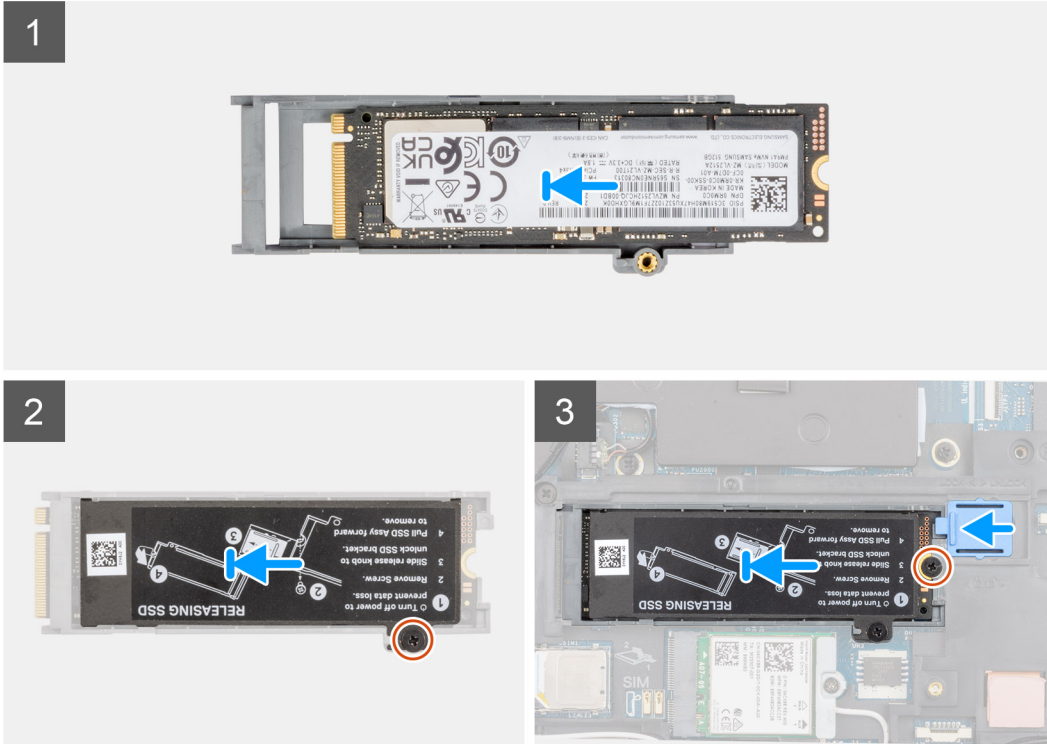
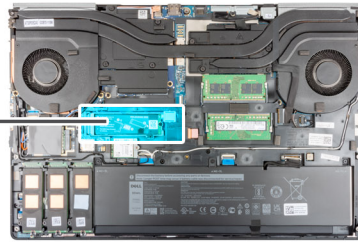

Steps

1. Place the M.2 2280 SSD onto its slot on the SSD carrier.
2. Align the tabs on the SSD thermal plate with the tab holes on the SSD carrier at an angle.
3. Place the SSD thermal plate above the M.2 SSD module.

i **NOTE:** Carefully align the tab hole on the thermal plate near the screw hole with the tab on the SSD carrier.

4. Replace the (M2x3) screw to secure the SSD thermal plate to the M.2 SSD module.
5. Replace the M.2 SSD module in its slot on the computer.
6. Replace the (M2x3) screw to secure the SSD module in place.
7. Slide the SSD release latch to lock the SSD module in place.
8. For computers shipped with SSD door configuration:
 - a. Close the SSD door until it clicks into place.

Next steps

1. Install the [base cover](#).
i **NOTE:** Follow this procedure only if the computer is shipped without SSD door configuration).
2. Install the [SD card](#).
3. Follow the procedure in [after working inside your computer](#).

Base cover

Removing the base cover

Prerequisites

1. Follow the procedure in [before working inside your computer](#).
2. Remove the [SD card](#).

About this task

The figure indicates the location of the base cover and provides a visual representation of the removal procedure.



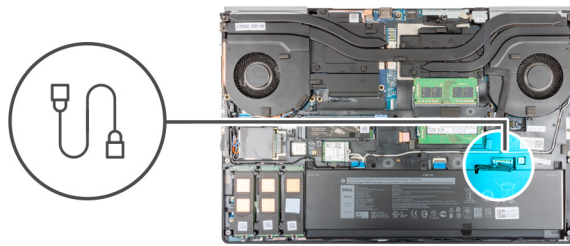
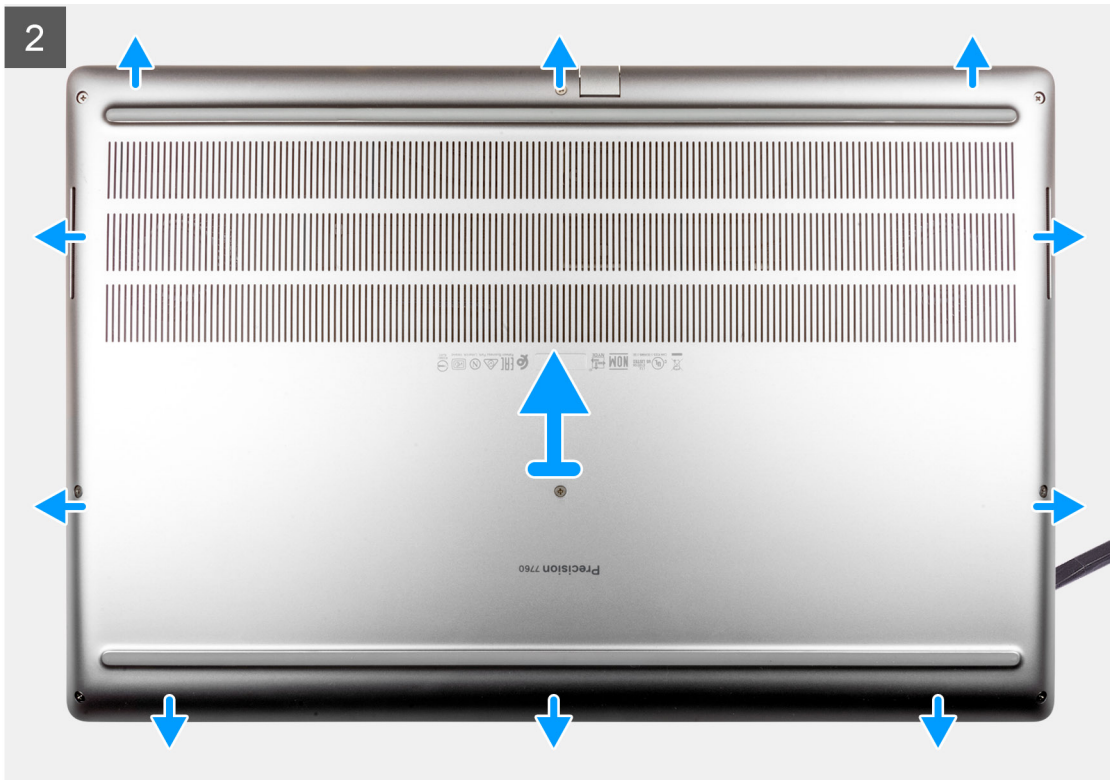

Steps

1. Loosen the eight captive screws that secure the base cover to the computer.
2. For computers shipped without a smart-card reader, pry open the base cover starting from the recess at the bottom edge of the cover.

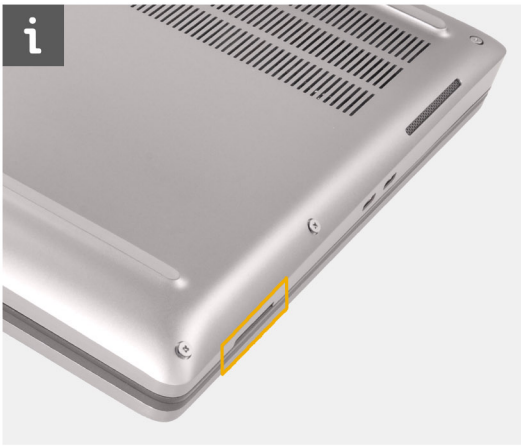

i **NOTE:** For models shipped with smart-card reader, pry open the base cover from the smart-card reader slot at the bottom right side of the base cover. Use your fingers to pry open the base cover as the use of plastic scribe or any other sharp objects may damage the base cover.



3. Lift the base cover starting from the bottom edge and push it towards the rear to remove it from the computer.

i **NOTE:** Do not lift the base cover directly upwards to remove, as this may damage the rear edge of the cover.

4. After removing the base cover, if any of the thermal pads for the M.2 SSD, WWAN card, and/or inner frame are detached, adhere them to their correct slot on the computer.

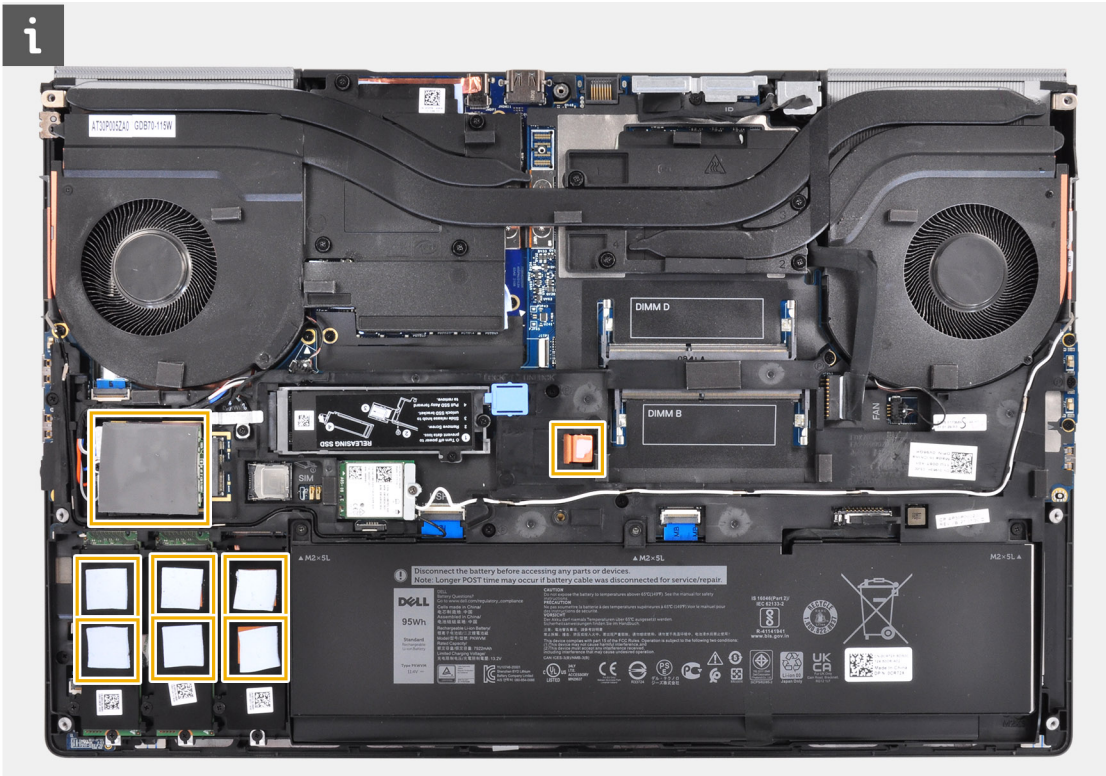

5. Disconnect the battery cable from the connector on the system board.

Installing the base cover

Prerequisites

If you are replacing a component, remove the existing component before performing the installation procedure.

About this task

The figure indicates the location of the base cover and provides a visual representation of the installation procedure.

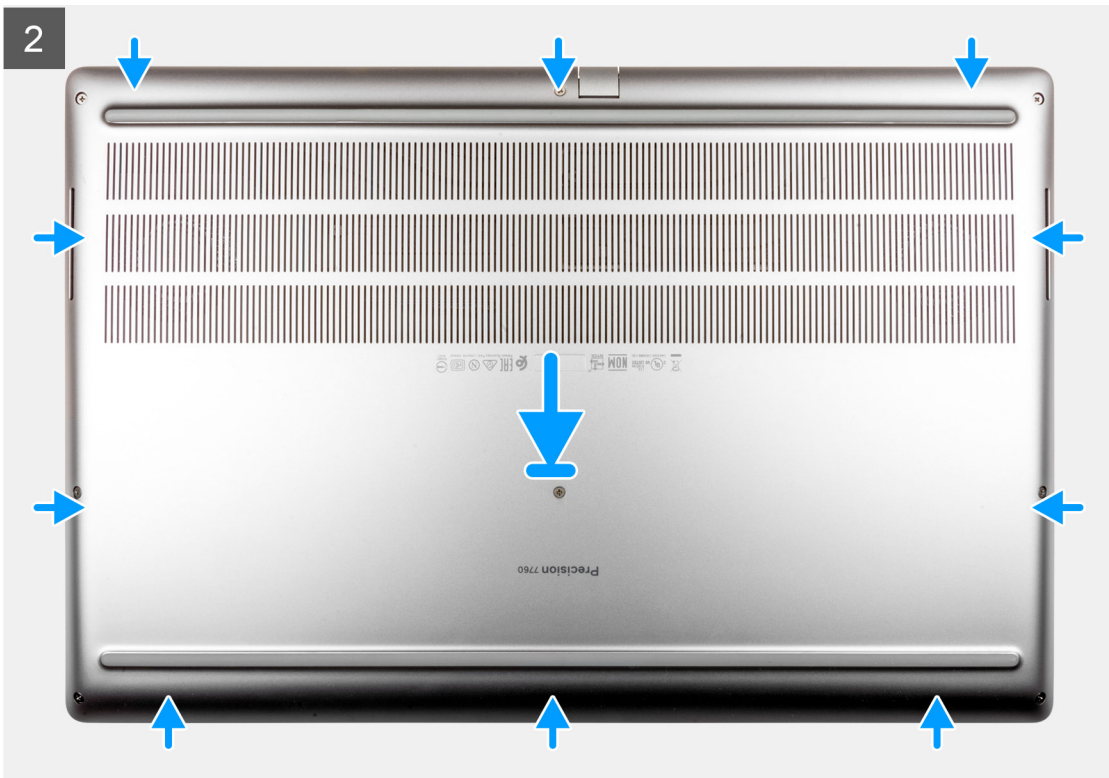
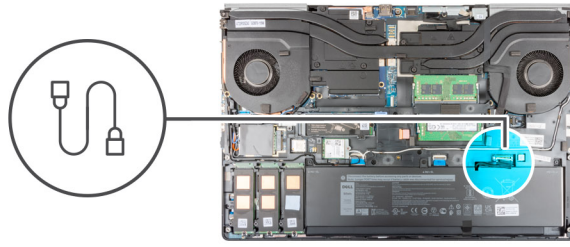



Steps

1. Connect the battery cable to the connector on the system board.
2. Slide the base cover into its slot until it clicks into place.
3. Tighten the eight captive screws to secure the base cover to the computer.

Next steps

1. Install the [SD card](#).
2. Follow the procedure in [after working inside your computer](#).

Battery

Lithium-ion battery precautions

⚠ CAUTION:

- Exercise caution when handling Lithium-ion batteries.
- Discharge the battery as much as possible before removing it from the system. This can be done by disconnecting the AC adapter from the system to allow the battery to drain.
- Do not crush, drop, mutilate, or penetrate the battery with foreign objects.
- Do not expose the battery to high temperatures, or disassemble battery packs and cells.
- Do not apply pressure to the surface of the battery.
- Do not bend the battery.

- Do not use tools of any kind to pry on or against the battery.
- Ensure any screws during the servicing of this product are not lost or misplaced, to prevent accidental puncture or damage to the battery and other system components.
- If the battery gets stuck inside your computer as a result of swelling, do not try to release it as puncturing, bending, or crushing a lithium-ion battery can be dangerous. In such an instance, contact Dell technical support for assistance. See www.dell.com/contactdell.
- Always purchase genuine batteries from www.dell.com or authorized Dell partners and resellers.

Removing the battery

Prerequisites

1. Follow the procedure in [before working inside your computer](#).
2. Remove the [SD card](#).
3. Remove the [base cover](#).

About this task

The figure indicates the location of the battery and provides a visual representation of the removal procedure.

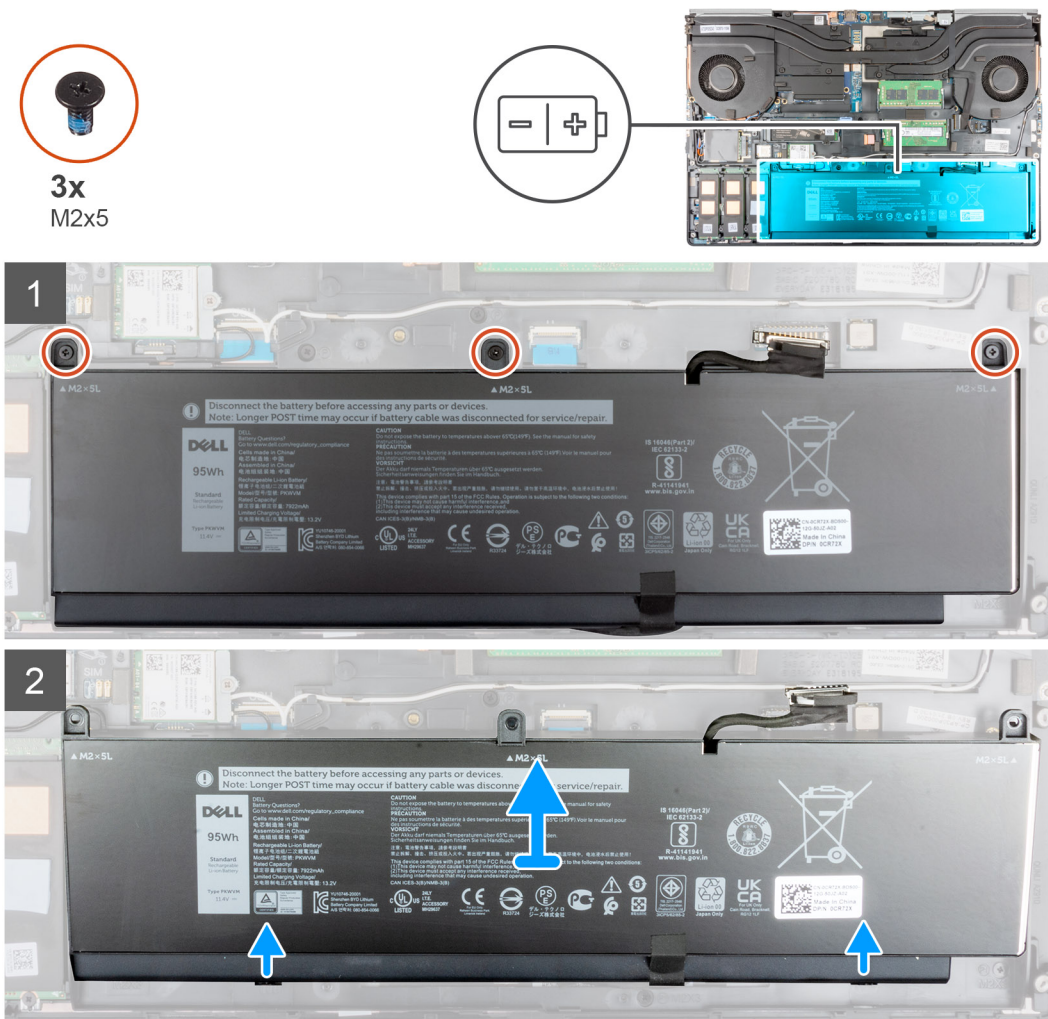

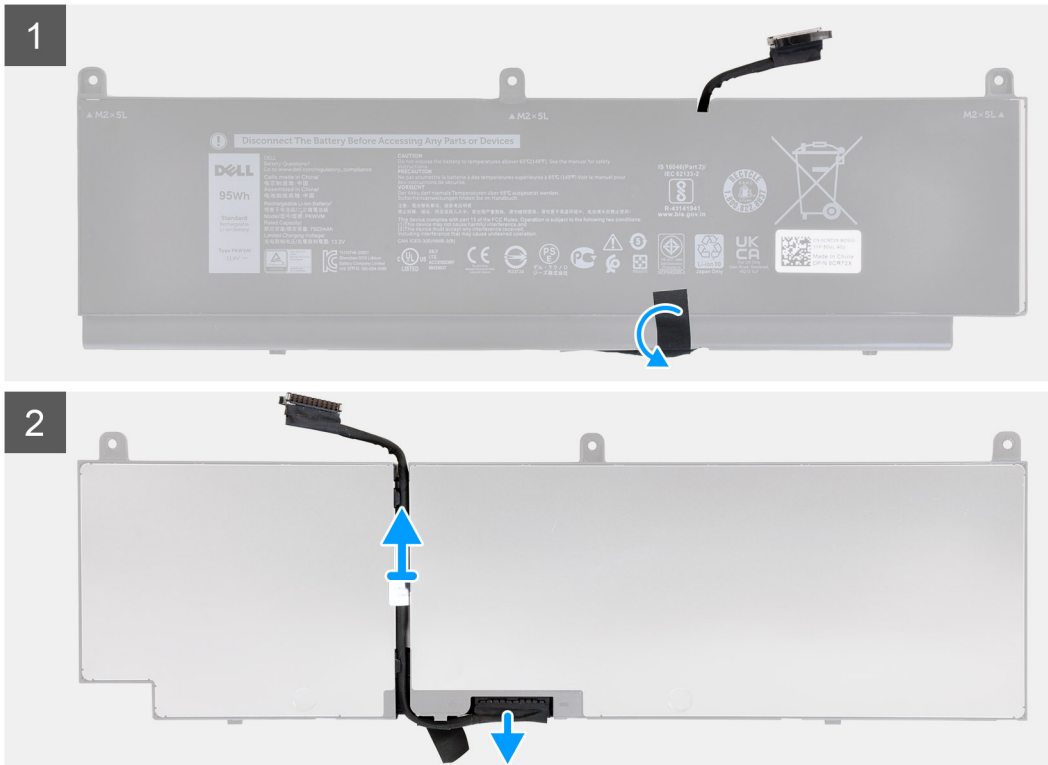

Steps

1. Remove the three (M2x5) screws that secure the battery to the computer.
2. Slightly lift the battery at an angle and slide the battery out of the computer chassis.
3. Peel the plastic tape to release the battery cable from the battery.
4. Unroute the battery cable from the routing guide in the battery.
5. Disconnect the battery cable from the connector on the battery.

Installing the battery

Prerequisites

If you are replacing a component, remove the existing component before performing the installation procedure.

About this task

The figure indicates the location of the battery and provides a visual representation of the installation procedure.

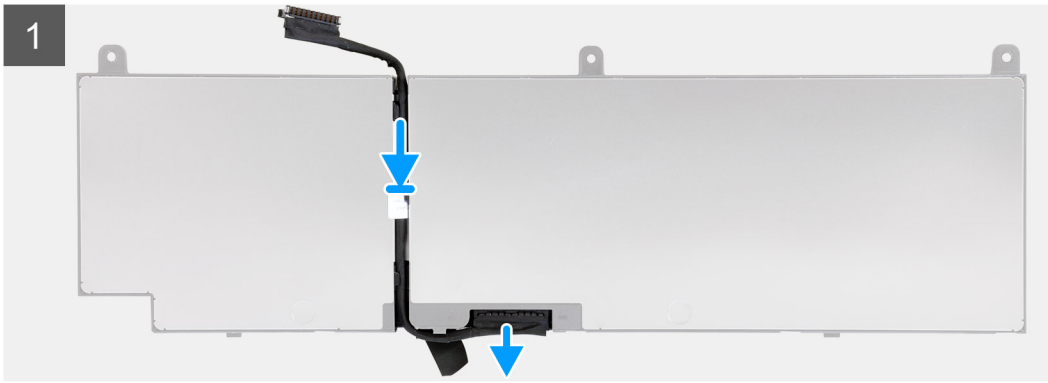

3x
M2x5

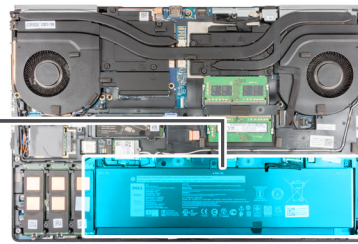
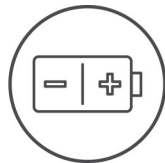

Steps

1. Route the battery cable through the routing guide on the battery.
2. Connect the battery cable to the connector on the battery.
3. Adhere the plastic tape to secure the battery cable to the battery.
4. Align the tabs on the battery at an angle with the tab holes on the computer chassis.
5. Place the battery onto its slot in the computer.
6. Replace the three (M2x5) screws to secure the battery to the computer.

Next steps

1. Install the [base cover](#).
2. Install the [SD card](#).
3. Follow the procedure in [after working inside your computer](#).

Solid State Drive

Removing the primary M.2 Solid-state drive

Prerequisites

 **NOTE:** For computers shipped with M.2 2280 or 2230 Solid-state drive installed in slot 3, slot 4, and/or slot 5.

 **NOTE:** Slot 3, slot 4, and slot 5 supports PCIe Gen3, Optane, and SATA Solid-state drive.

1. Follow the procedure in [before working inside your computer](#).
2. Remove the [SD card](#).
3. Remove the [base cover](#).

About this task

The figure indicates the location of the primary M.2 SSD and provides a visual representation of the removal procedure.

M.2 2280 SSD

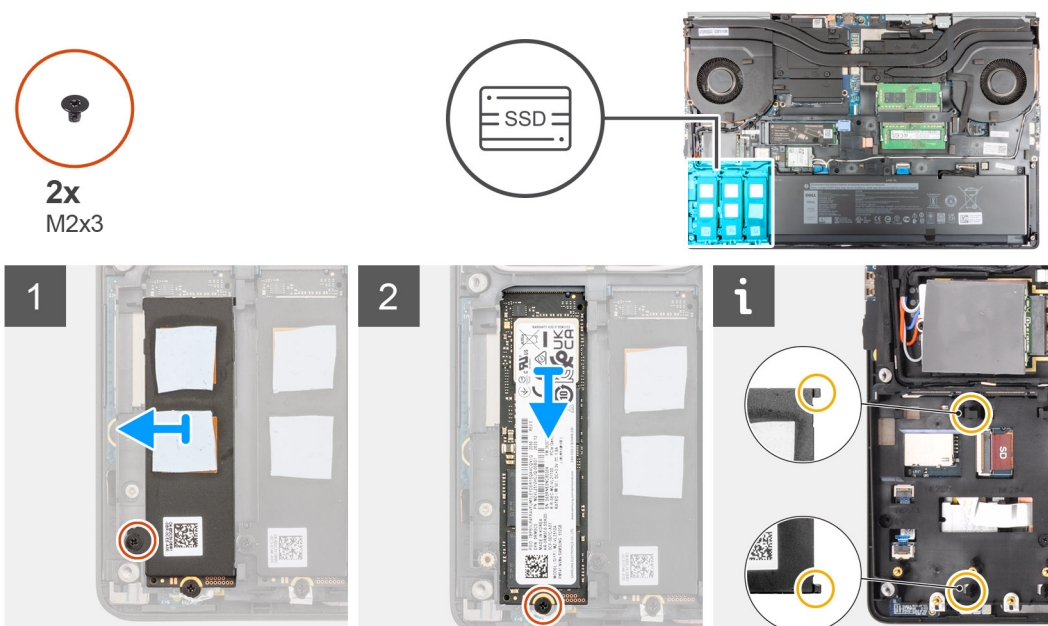

M.2 2230 SSD

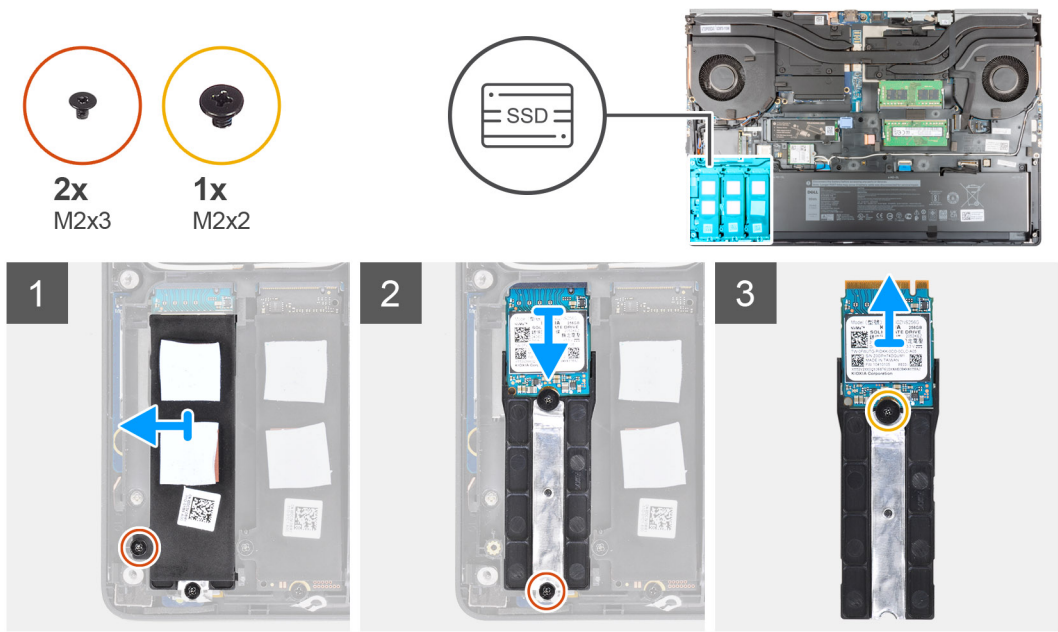

Steps

1. Remove the (M2x3) screw that secures the SSD thermal plate to the M.2 SSD module.
2. Carefully tilt at an angle and then slide to remove the SSD thermal plate from the slots on the inner frame.
3. For M.2 2280 SSD:
 - a. Remove the (M2x3) screw that secures the M.2 SSD to the computer.
 - b. Remove the M.2 SSD.
4. For M.2 2230 SSD:
 - a. Remove the (M2x3) screw that secures the SSD module.
 - b. Remove the SSD module from the computer.
 - c. Remove the (M2x2) screw that secures the SSD to SSD holder.
 - d. Remove the SSD from the holder.
5. Repeat the above steps to remove the other SSD modules in the computer.

Installing the primary M.2 SSD module

Prerequisites

NOTE: For computers shipped with M.2 2280 or 2230 Solid-state drive installed in slot 3, slot 4, and/or slot 5.

NOTE: Slot 3, slot 4, and slot 5 supports PCIe Gen3, Optane, and SATA Solid-state drive.

If you are replacing a component, remove the existing component before performing the installation procedure.

About this task

The figure indicates the location of the primary M.2 SSD and provides a visual representation of the installation procedure.

M.2 2280 SSD



2x
M2x3

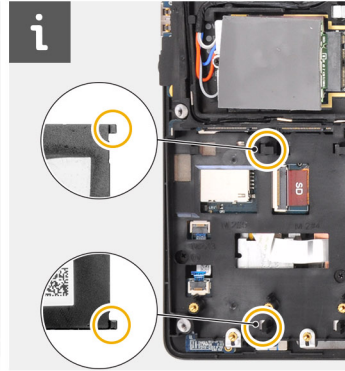
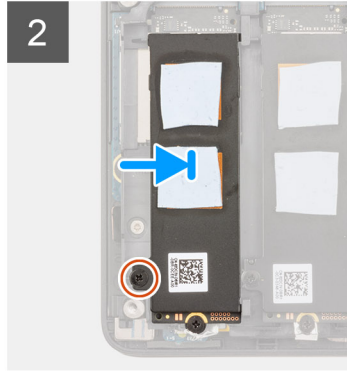
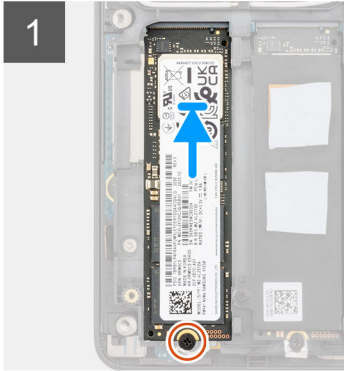
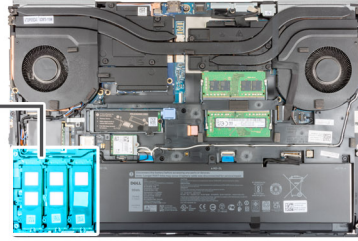

M.2 2230 SSD



2x
M2x3



1x
M2x2

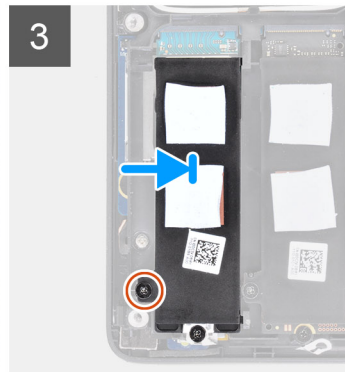
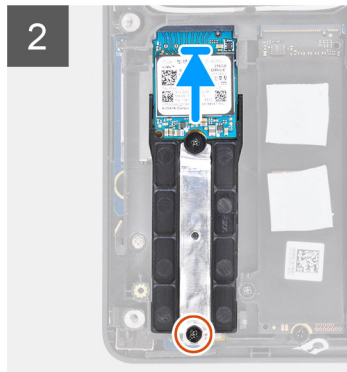
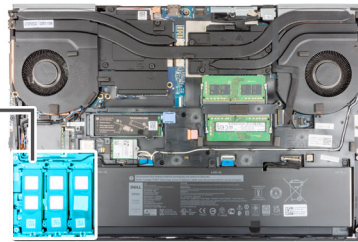

Steps

1. For M.2 2280 SSD:
 - a. Place the M.2 SSD onto its slot on the computer.
 - b. Replace the (M2x3) screw to secure the M.2 SSD to the computer.
2. For M.2 2230 SSD:
 - a. Place the M.2 SSD into the SSD holder.
 - b. Replace the (M2x2) screw to secure the M.2 SSD to the holder.
 - c. Place the M.2 SSD module onto its slot on the computer.
 - d. Replace the (M2x3) screw to secure the M.2 SSD module to the computer.
3. Carefully align and insert the two tabs on the SSD thermal plate into the slots on the inner frame to secure the SSD thermal plate in place.
4. Replace the (M2x3) screw to secure the SSD thermal plate to the M.2 SSD.
5. Repeat the above steps to install the other SSD modules in the computer.

Next steps

1. Install the [base cover](#).
2. Install the [SD card](#).
3. Follow the procedure in [after working inside your computer](#).

Secondary memory module

Removing the secondary memory module

Prerequisites

1. Follow the procedure in [before working inside your computer](#).
2. Remove the [SD card](#).
3. Remove the [base cover](#).

About this task

The figure indicates the location of the secondary memory module and provides a visual representation of the removal procedure.

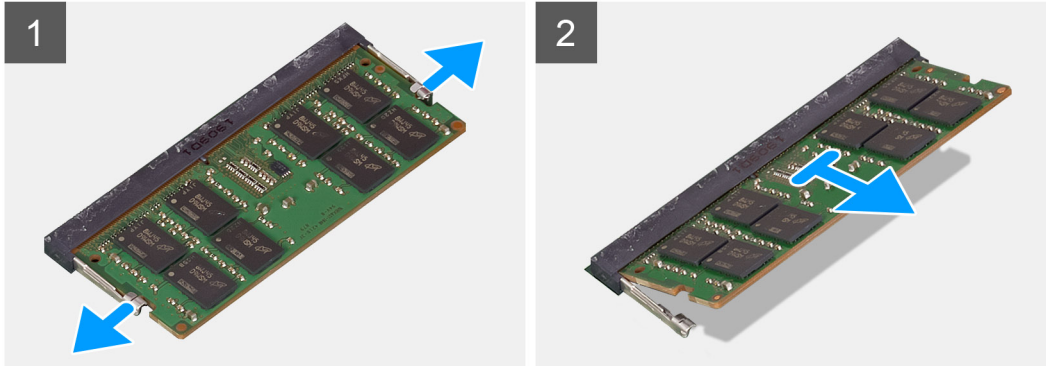
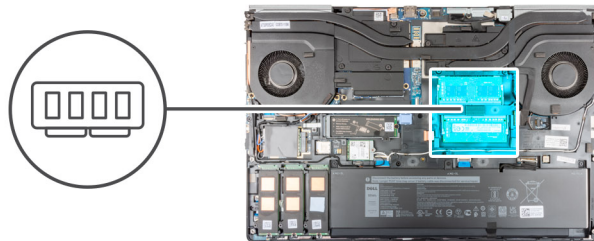

Steps

1. Pry the securing clips from both side of the memory module until the memory module pops up.
2. Remove the memory module from the memory-module slot.

Installing the secondary memory module

Prerequisites

If you are replacing a component, remove the existing component before performing the installation procedure.

About this task

The figure indicates the location of the secondary and provides a visual representation of the installation procedure.

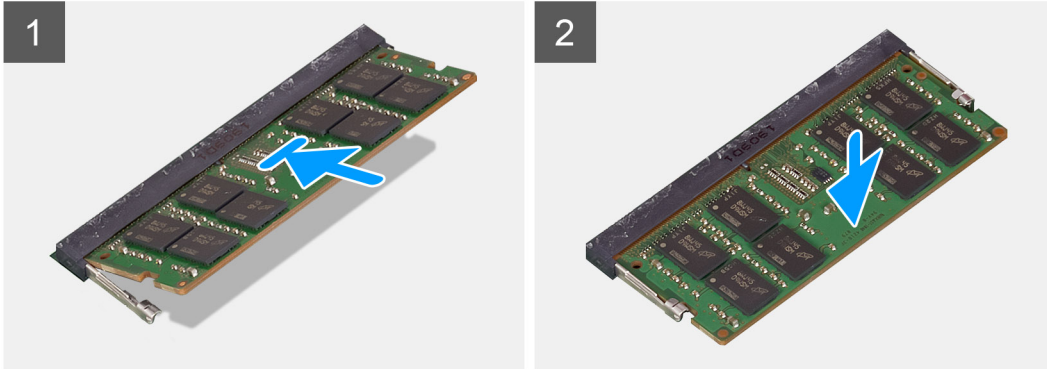
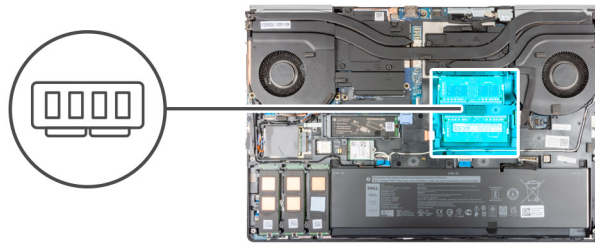

Steps

1. Align the notch on the memory module with the tab on the memory-module slot.
2. Slide the memory module firmly into the slot and press the memory module until it clicks into place.

i NOTE: If you do not hear the click, remove the memory module and reinstall it.

Next steps

1. Install the [base cover](#).
2. Install the [SD card](#).
3. Follow the procedure in [after working inside your computer](#).

SIM card

Removing the SIM card

Prerequisites

1. Follow the procedure in [before working inside your computer](#).
2. Remove the [SD card](#).
3. Remove the [base cover](#).

About this task

The figure indicates the location of the SIM card and provides a visual representation of the removal procedure.

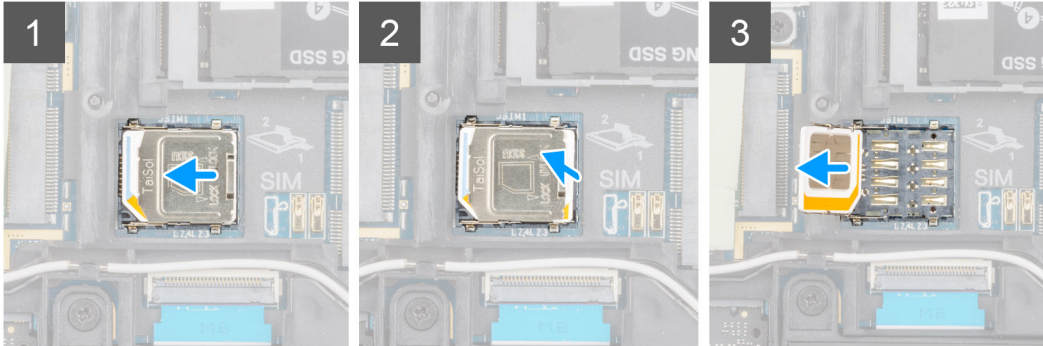
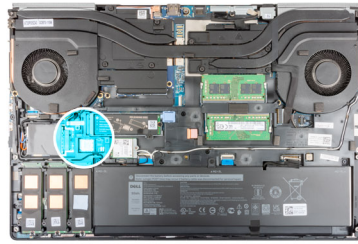

Steps

1. Gently slide the SIM card cover towards the left side of the SIM card slot to unlock the SIM card cover.

 **CAUTION:** The SIM card cover is fragile and can be easily damaged if it is not properly unlocked before opening.

2. Flip the right edge of the SIM card cover to open it.
3. Remove the SIM card from the SIM card slot.

Installing the SIM card

Prerequisites

If you are replacing a component, remove the existing component before performing the installation procedure.

About this task

The figure indicates the location of the SIM card and provides a visual representation of the installation procedure.

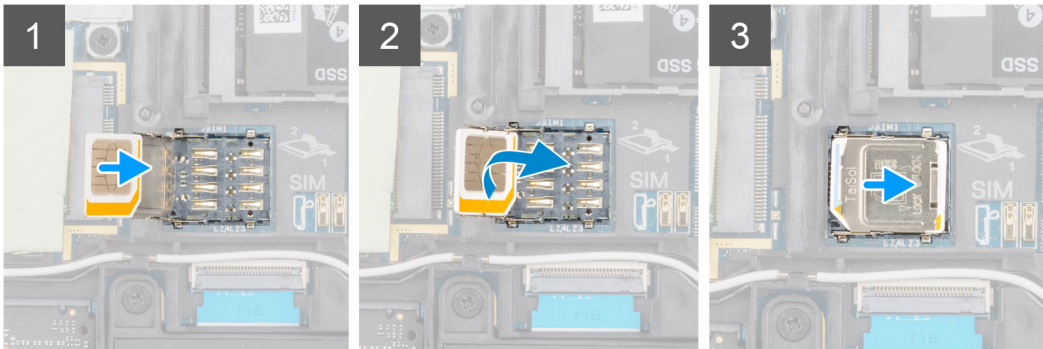
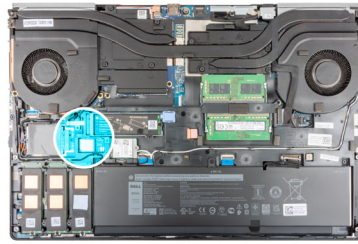

Steps

1. Slide the SIM card into the SIM card slot.
2. Snap the SIM card cover down.
3. Slide the SIM card cover towards the right of the computer to lock the cover.

Next steps

1. Install the [base cover](#).
2. Install the [SD card](#).
3. Follow the procedure in [after working inside your computer](#).

WLAN card

Removing the WLAN card

Prerequisites

1. Follow the procedure in [before working inside your computer](#).
2. Remove the [SD card](#).
3. Remove the [base cover](#).

About this task

The figure indicates the location of the WLAN card and provides a visual representation of the removal procedure.



1x

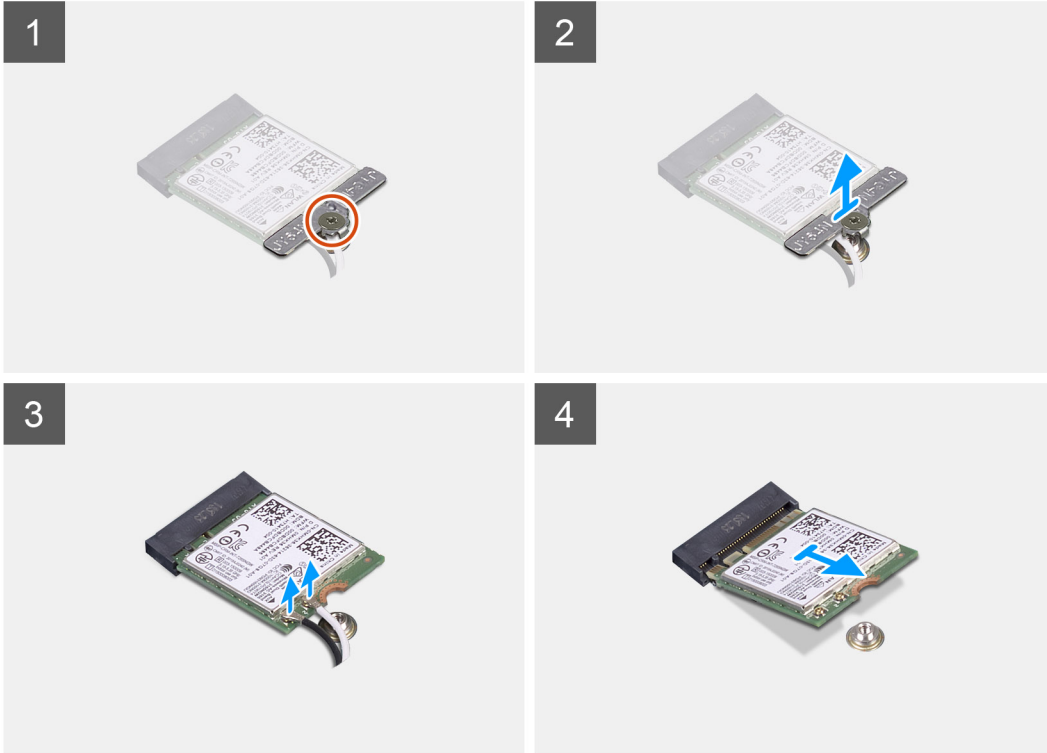
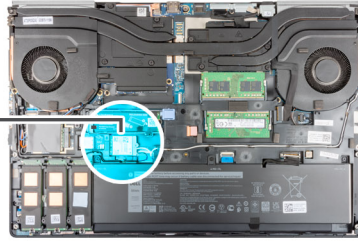

Steps

1. Loosen the captive screw that secures the WLAN card bracket to the system board.
2. Remove the WLAN card bracket away from the WLAN card.
3. Disconnect the antenna cables from the WLAN card.
4. Slide at an angle and remove the WLAN card from the connector on the system board.

Installing the WLAN card

Prerequisites

If you are replacing a component, remove the existing component before performing the installation procedure.

About this task

The figure indicates the location of the WLAN card and provides a visual representation of the installation procedure.



1x

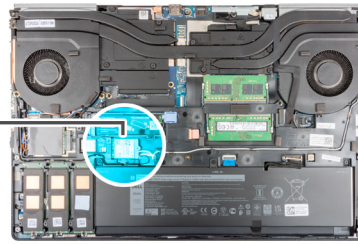

Steps

1. Connect the antenna cables to the WLAN card.

The following table provides the antenna-cable color scheme for the WLAN card of your computer.

Table 2. Antenna-cable color scheme

Connectors on the wireless card	Antenna-cable color
Main (white triangle)	White
Auxiliary (black triangle)	Black

2. Align the notch on the WLAN card with the WLAN connector and insert the WLAN card at an angle into the WLAN card slot.
3. Align and place the WLAN card bracket to secure the WLAN antenna cables to the WLAN card.
4. Tighten the captive screw to secure the WLAN card bracket to the system board.

Next steps

1. Install the [base cover](#).
2. Install the [SD card](#).
3. Follow the procedure in [after working inside your computer](#).

WWAN card

Removing the WWAN card

Prerequisites

1. Follow the procedure in [before working inside your computer](#).
2. Remove the [SD card](#).
3. Remove the [base cover](#).

About this task

The figure indicates the location of the WWAN card and provides a visual representation of the removal procedure.

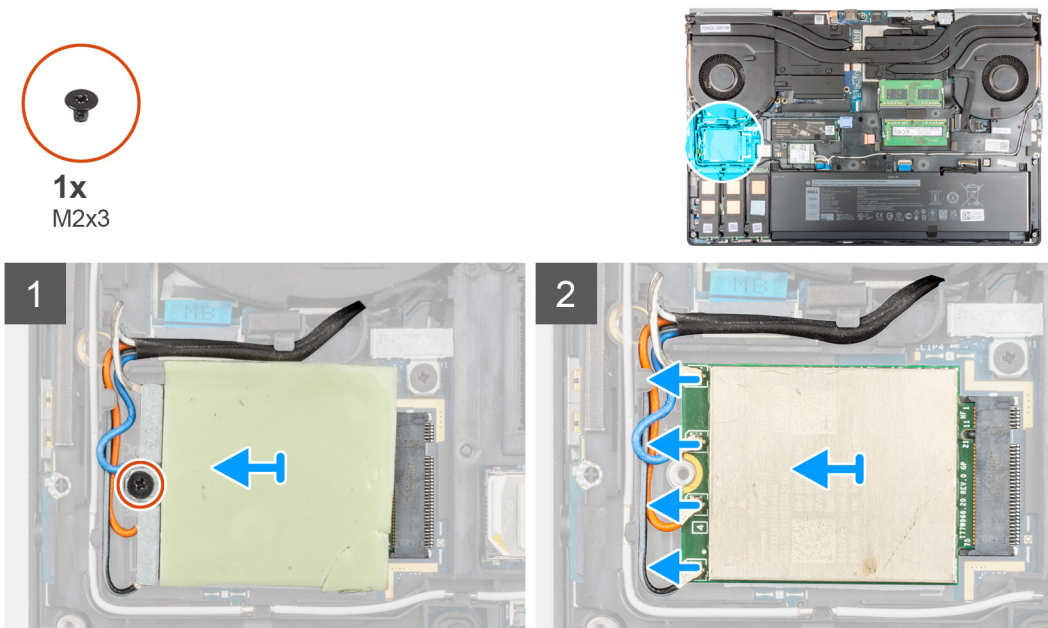

Steps

1. Loosen the (M2x3) screw that secures the WWAN card bracket to the system board.
2. Lift the WWAN card bracket from the WWAN card.
3. Disconnect the antenna cables from the connector on the WWAN card.
4. Slide and remove the WWAN card from its slot on the system board.

NOTE: When replacing the system board, the sticker indicating the WWAN antenna cable connections must be relocated to the replacement system board.

Installing the WWAN card

Prerequisites

If you are replacing a component, remove the existing component before performing the installation procedure.

About this task

The figure indicates the location of the WWAN card and provides a visual representation of the installation procedure.



1x
M2x3

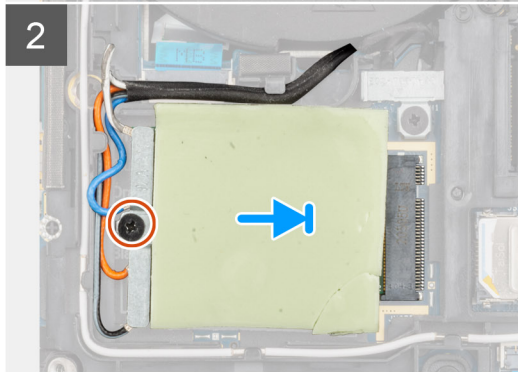
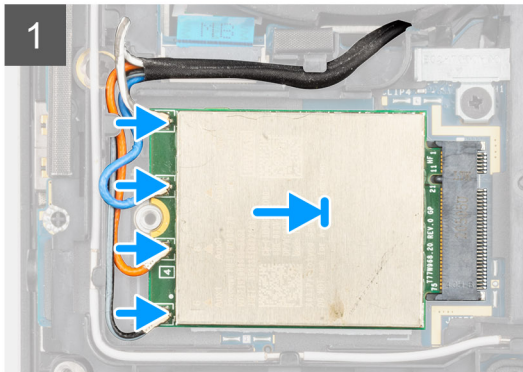
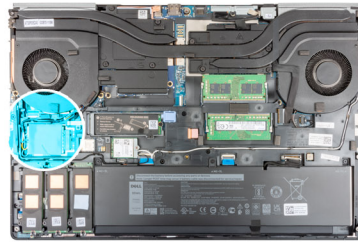

Steps

1. Connect the antenna cables to the connectors on the WWAN card. The following table provides the antenna-cable color scheme for the WWAN card of your computer.

Table 3. Antenna-cable color scheme

Antenna Cable Color	Pin Definition
White / Grey	ANT0
Blue	ANT1
Orange	ANT2
Black / Grey	ANT3

The connections are also printed on the WWAN card slot.

2. Align and slide the WWAN card to its slot on the system board.
3. Place the WWAN card bracket above the WWAN card to secure the antenna cables.
4. Tighten the (M2x3) screw to secure the WWAN card bracket to the system board.

Next steps

1. Install the [base cover](#).
2. Install the [SD card](#).
3. Follow the procedure in [after working inside your computer](#).

Keyboard lattice

Removing the keyboard lattice

Prerequisites

1. Follow the procedure in [before working inside your computer](#).
2. Remove the [SD card](#).
3. Remove the [base cover](#).

About this task

The figure indicates the location of the keyboard lattice and provides a visual representation of the removal procedure.

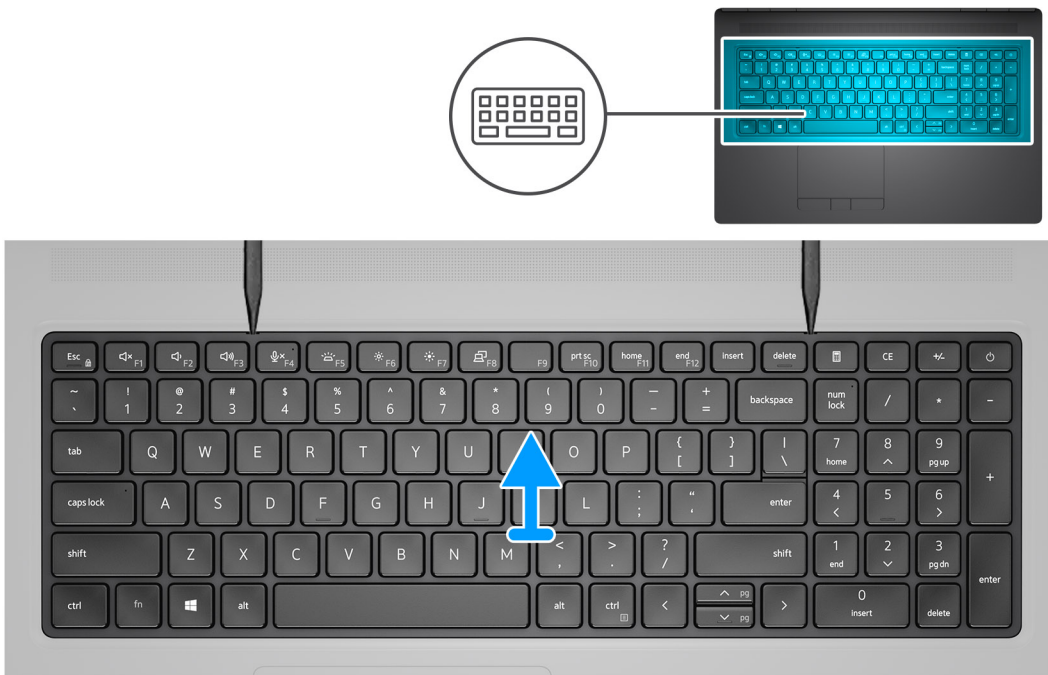

Steps

1. Using a plastic scribe, pry the top edge of the keyboard lattice starting from the recess points and working your way around the sides and bottom edge.
2. Remove the keyboard lattice from the keyboard.

Installing the keyboard lattice

Prerequisites

If you are replacing a component, remove the existing component before performing the installation procedure.

About this task

The figure indicates the location of the keyboard lattice and provides a visual representation of the installation procedure.

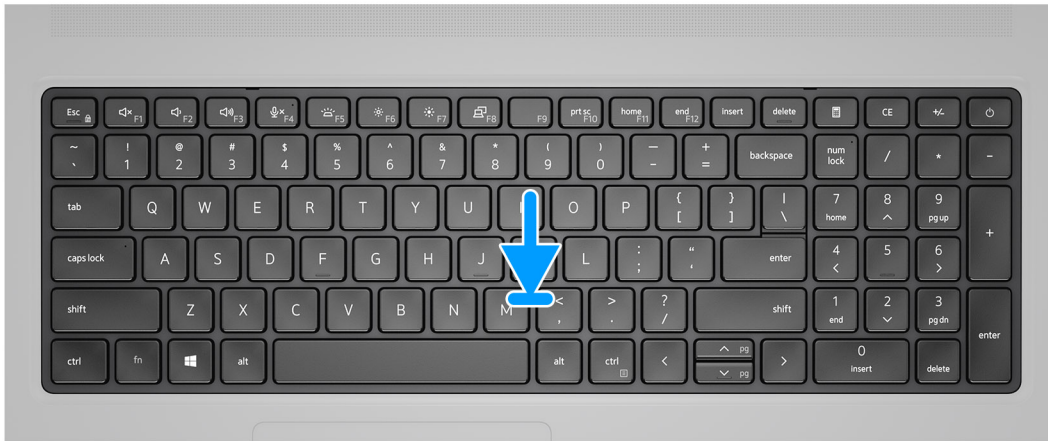

Steps

1. Align the keyboard lattice to its position on the keyboard.
2. Press the edges on the keyboard lattice until it clicks into place.

Next steps

1. Install the [base cover](#).
2. Install the [SD card](#).
3. Follow the procedure in [after working inside your computer](#).

Keyboard

Removing the keyboard

Prerequisites

1. Follow the procedure in [before working inside your computer](#).
2. Remove the [SD card](#).
3. Remove the [base cover](#).
4. Remove the [battery](#).
5. Remove the [keyboard lattice](#).

About this task

The figure indicates the location of the keyboard and provides a visual representation of the removal procedure.



6x
M2x2

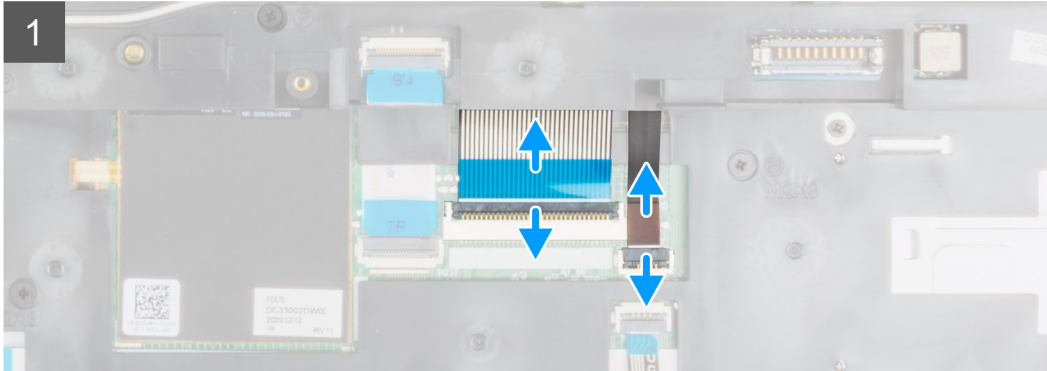

Steps

1. Lift the latch and disconnect the keyboard FPC and the keyboard backlight FPC from the connectors on the touchpad module.
2. Turn-over and open the system at 90° angle.
3. Remove the six (M2x2) screws that secure the keyboard to the palmrest.
4. Pry the bottom edge of the keyboard and then work along the left and the right sides of the keyboard.
5. Carefully unrout the keyboard backlight FPC and the keyboard FPC through the opening on the palmrest.
6. Remove the keyboard from the computer.

Installing the keyboard

Prerequisites

If you are replacing a component, remove the existing component before performing the installation procedure.

About this task

The figure indicates the location of the keyboard and provides a visual representation of the installation procedure.



6x
M2x2

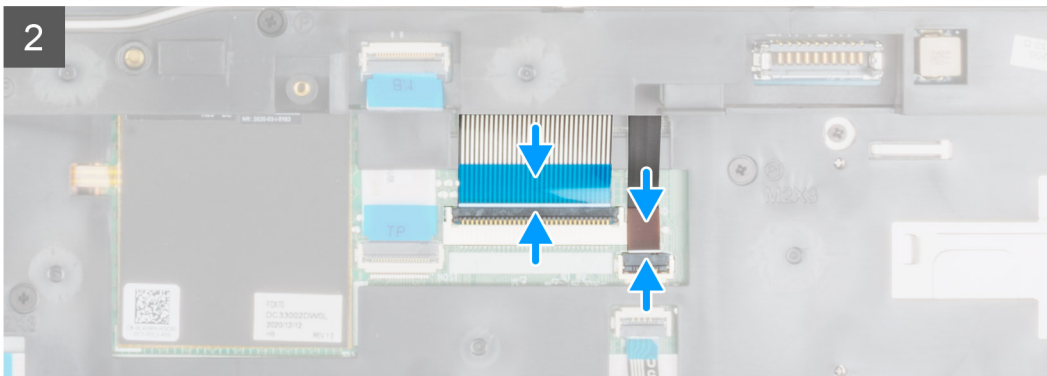

Steps

1. Route the keyboard FPC and the keyboard backlight FPC through the opening on the palmrest.
2. Align the tabs on the keyboard with the tabs on the computer chassis at an angle.
3. Place the keyboard on the palmrest.
4. Replace the six (M2x2) screws to secure the keyboard to the palmrest.
5. Turn-over the system at 90° angle to access the keyboard FPC and the keyboard backlight FPC.
6. Connect the keyboard backlight FPC and the keyboard FPC to the connectors on the system board.

 **NOTE:** Ensure that you fold the keyboard data cable in perfect alignment.

Next steps

1. Install the [keyboard lattice](#).
2. Install the [battery](#).
3. Install the [base cover](#).
4. Install the [SD card](#).
5. Follow the procedure in [after working inside your computer](#).

Primary memory module

Removing the primary memory module

Prerequisites

1. Follow the procedure in [before working inside your computer](#).
2. Remove the [SD card](#).
3. Remove the [base cover](#).
4. Remove the [battery](#).
5. Remove the [keyboard lattice](#).
6. Remove the [keyboard](#).

About this task

The figure indicates the location of the primary memory module and provides a visual representation of the removal procedure.

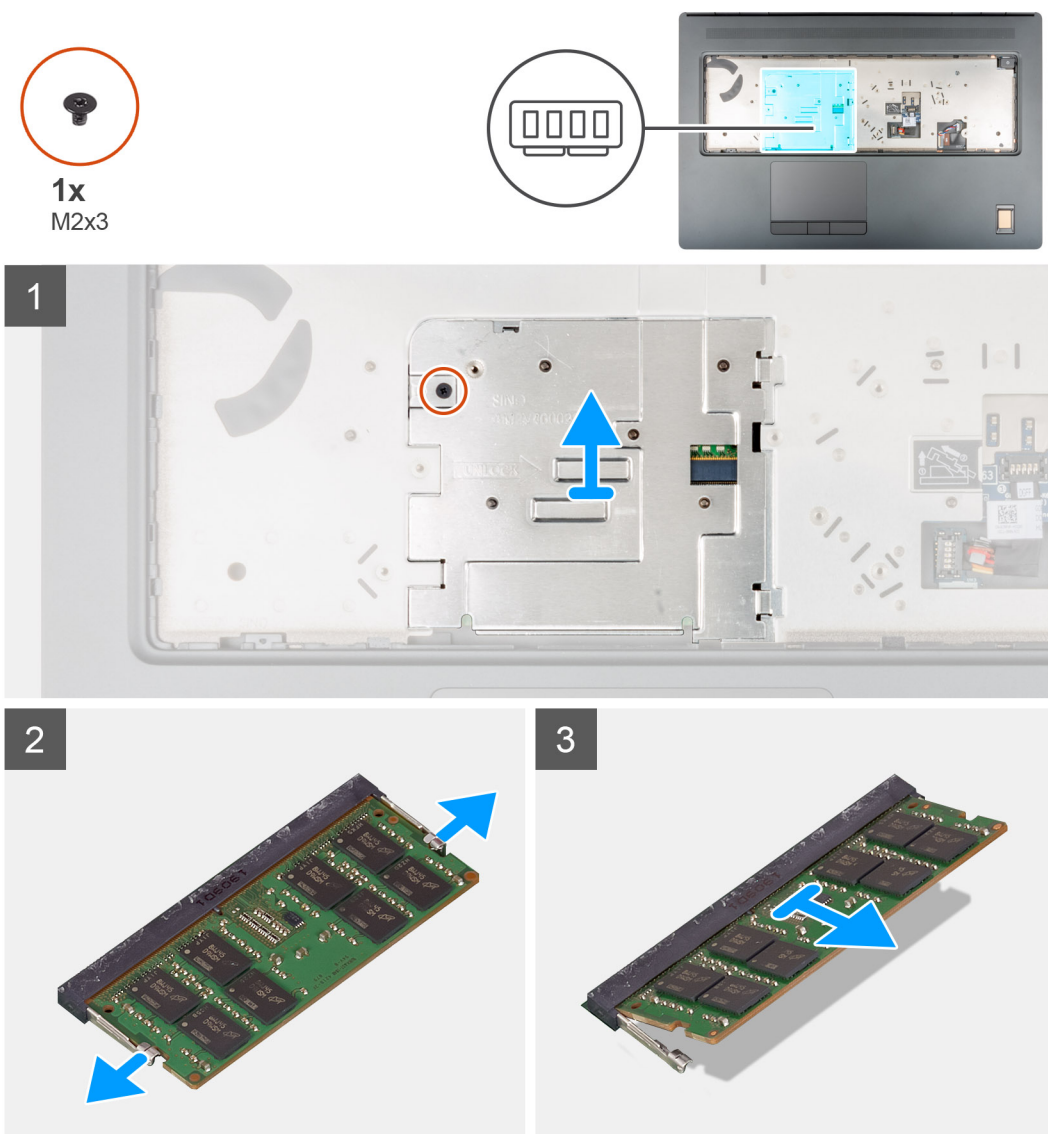

Steps

1. Remove the (M2x3) screw that secures the memory shield in place.
2. Slide the memory shield towards the right side of the computer and lift the shield from the memory module.

3. Pry the securing clips from both side of the memory module until the memory module pops up.
4. Remove the memory module from the memory-module slot.

NOTE: Repeat the above steps if there are other memory installed.

Installing the primary memory module

Prerequisites

If you are replacing a component, remove the existing component before performing the installation procedure.

About this task

The figure indicates the location of the primary memory module and provides a visual representation of the installation procedure.

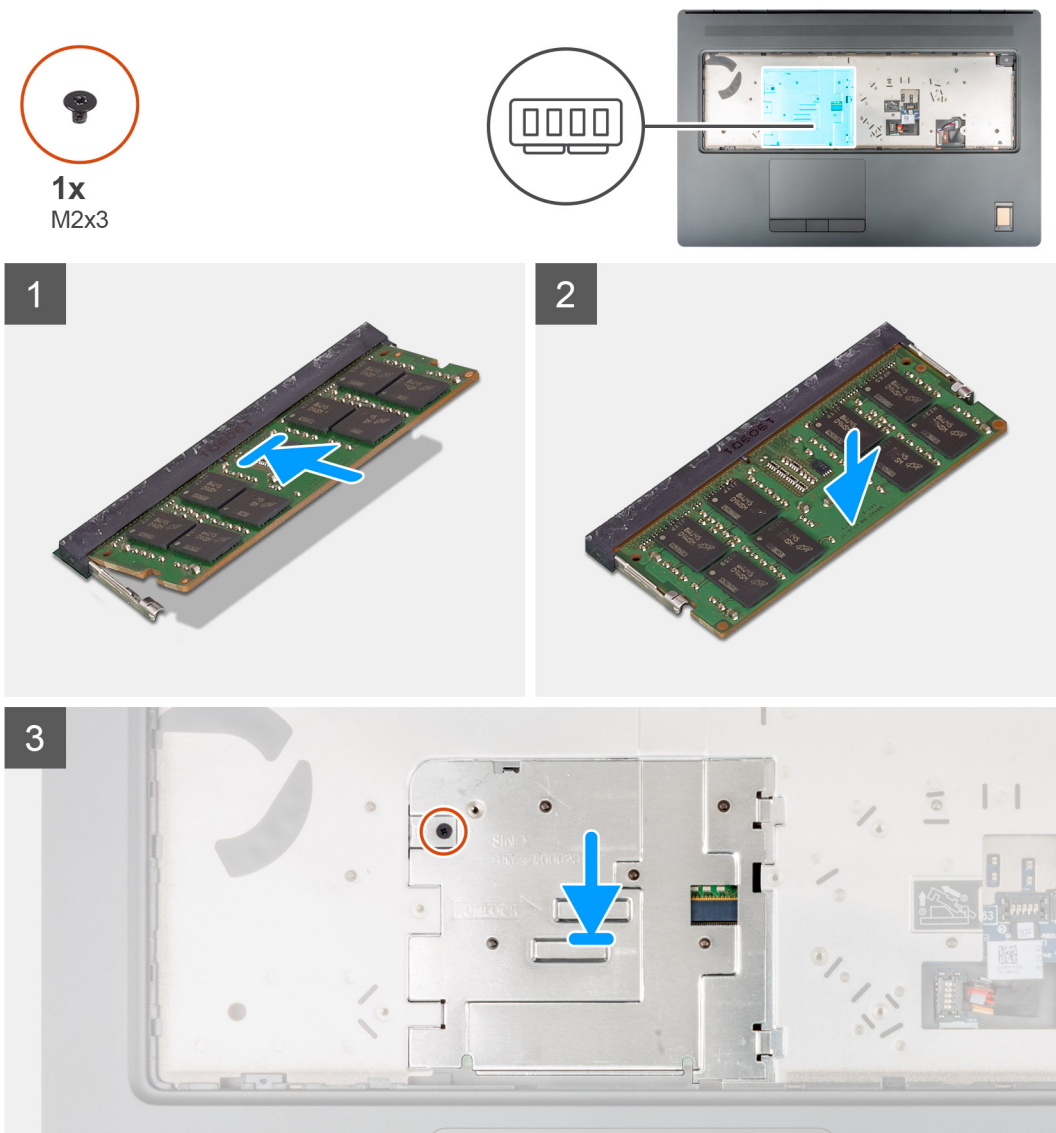

Steps

1. Align the notch on the memory module with the tab on the memory-module slot.
2. Slide the memory module firmly into the slot at an angle and press the memory module down until it clicks into place.

3. Carefully align the two clips on the memory shield with the slots on the computer chassis and insert the clips under the chassis.
4. Place the memory shield and slide it towards the left side of the computer to cover the memory module.
5. Replace the (M2x3) screw to secure the memory shield to the memory module.

Next steps

1. Install the [keyboard](#).
2. Install the [keyboard lattice](#).
3. Install the [battery](#).
4. Install the [base cover](#).
5. Install the [SD card](#).
6. Follow the procedure in [after working inside your computer](#).

Inner frame

Removing the inner frame

Prerequisites

1. Follow the procedure in [before working inside your computer](#).
2. Remove the [SD card](#).
3. Remove the [base cover](#).
4. Remove the [battery](#).
5. Remove the [WLAN card](#).
6. Remove the [WWAN card](#).
7. Remove the [primary M.2 SSD](#).

About this task

The figure indicates the location of the inner frame and provides a visual representation of the removal procedure.



10x
M2x3

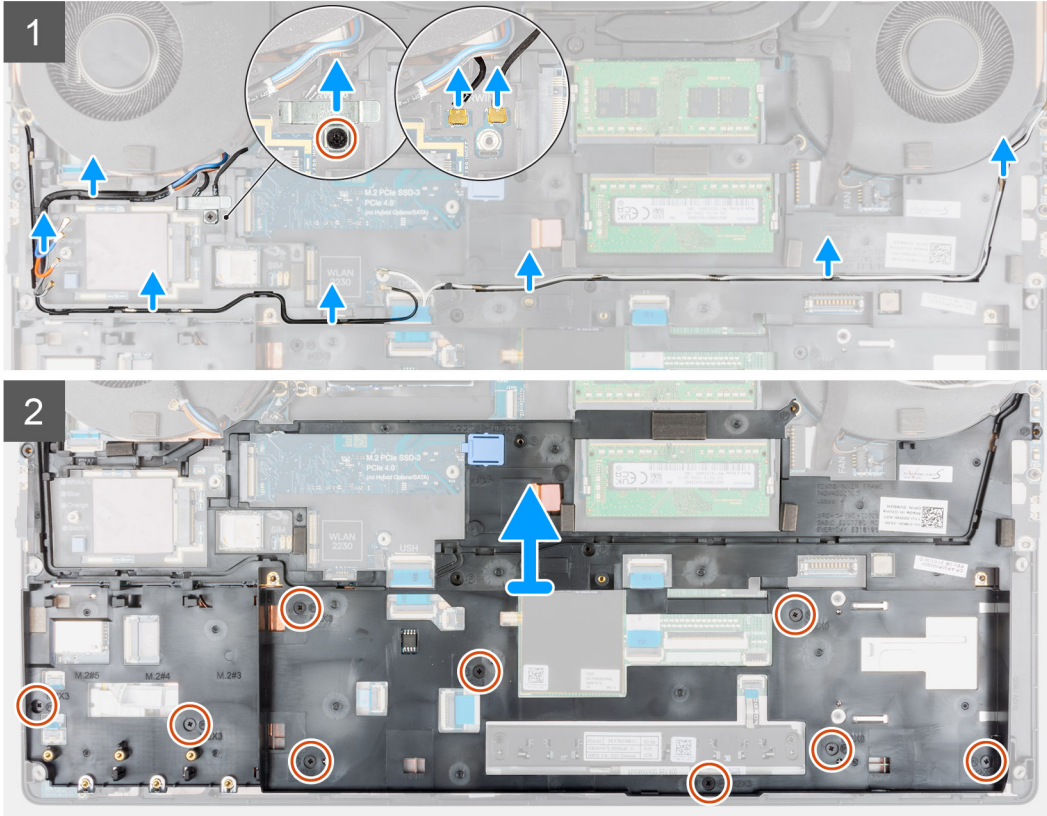
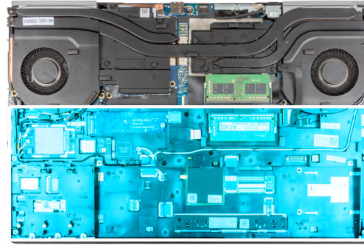

Steps

1. For the computers shipped with WWAN card:
 - a. Remove the (M2x3) screw that secures the Darwin bracket in place.
 - b. Remove the Darwin bracket away from the computer.
 - c. Disconnect the two Darwin antenna cables from the connector on the system board.
2. Unroute the WLAN and WWAN antenna cables from the routing guide.
3. Disconnect the keyboard FPC and the keyboard backlight FPC from the connector on the touchpad module.
4. Remove the ten (M2x3) screws that secure the inner frame to the computer chassis.
5. Remove the inner frame from the computer while carefully unthreading the keyboard FPC and keyboard backlight FPC through the opening on the inner frame.

NOTE: If the thermal pad attached to the bottom side of the inner frame is detached, while removing the inner frame, adhere it back to its correct location.

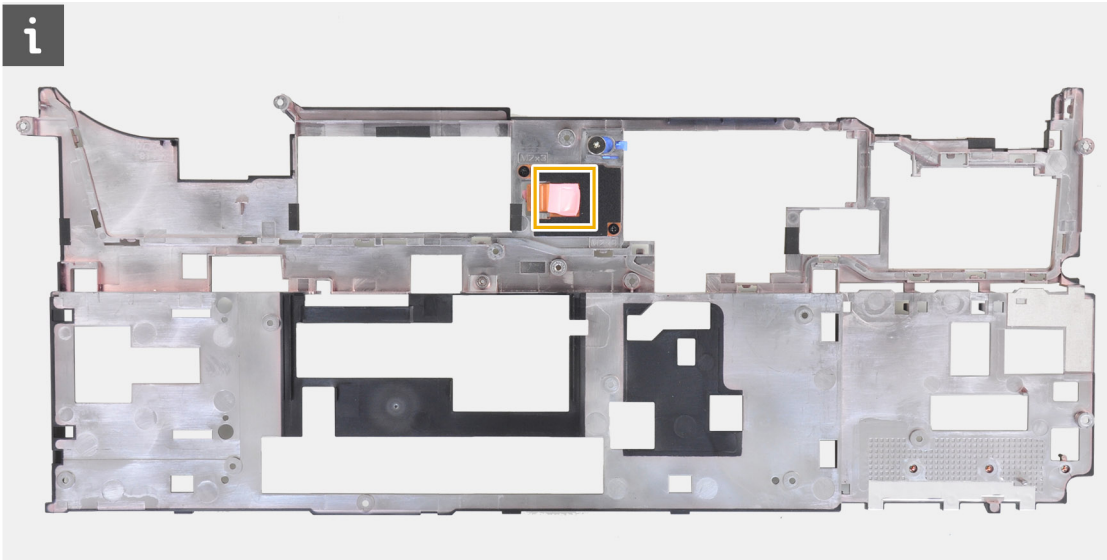

Installing the inner frame

Prerequisites

If you are replacing a component, remove the existing component before performing the installation procedure.

About this task

The figure indicates the location of the inner frame and provides a visual representation of the installation procedure.



10x
M2x3

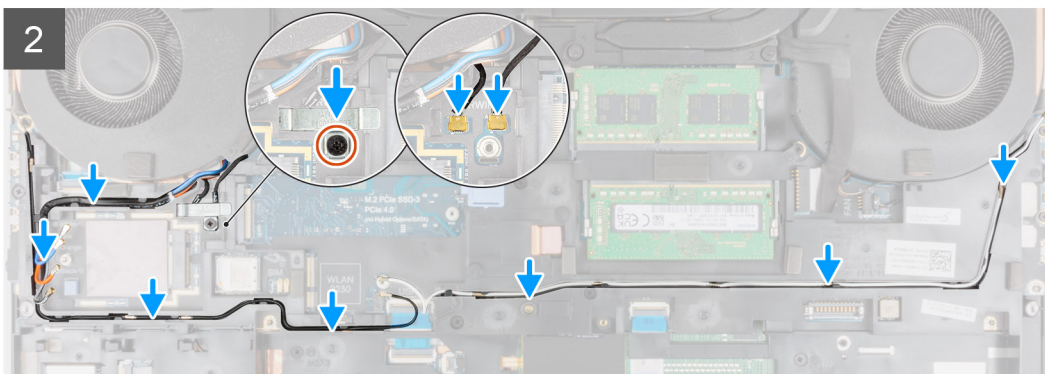
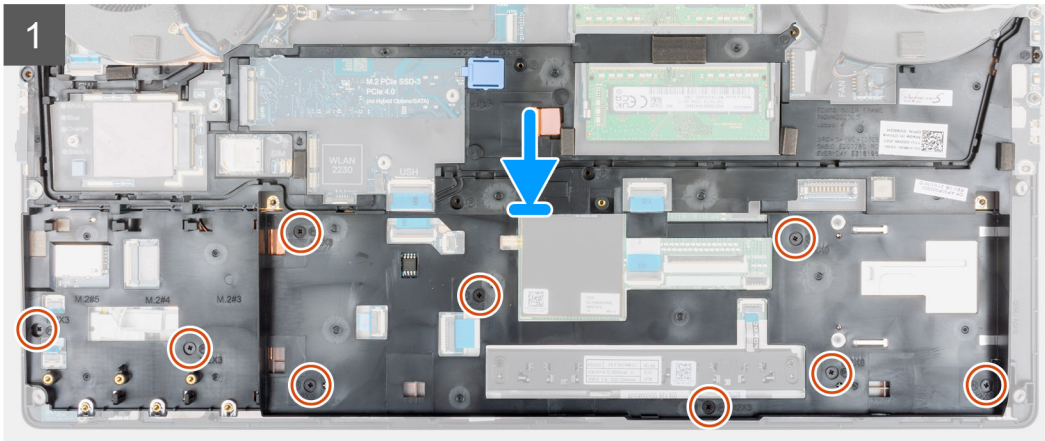
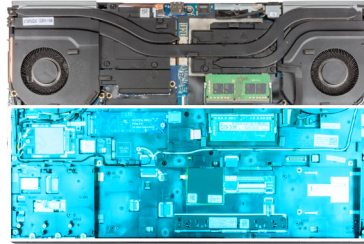

Steps

1. Carefully route the keyboard FPC and keyboard backlight FPC through the inner frame and place the inner frame on the computer chassis.
2. Replace the ten (M2x3) screws to secure the inner frame in place.
3. Route the WLAN and WWAN antenna cables through the routing guide.
4. For the computers shipped with WWAN card:
 - a. Connect the two Darwin antenna cables to the connector on the system board.
 - b. Align and place the Darwin bracket to secure the Darwin antenna cables to the system board.
 - c. Replace the (M2x3) screw to secure the Darwin bracket in place.

Next steps

1. Install the [WWAN card](#).
2. Install the [WLAN card](#).
3. Install the [primary M.2 SSD](#).
4. Install the [battery](#).
5. Install the [base cover](#).
6. Install the [SD card](#).
7. Follow the procedure in [after working inside your computer](#).

Smart-card reader

Removing the smart-card reader

Prerequisites

1. Follow the procedure in [before working inside your computer](#).
2. Remove the [SD card](#).
3. Remove the [base cover](#).
4. Remove the [battery](#).
5. Remove the [WLAN card](#).
6. Remove the [WWAN card](#).
7. Remove the [primary M.2 SSD](#).
8. Remove the [inner frame](#).

About this task

The figure indicates the location of the smart-card reader and provides a visual representation of the removal procedure.



2x
M2x2.5

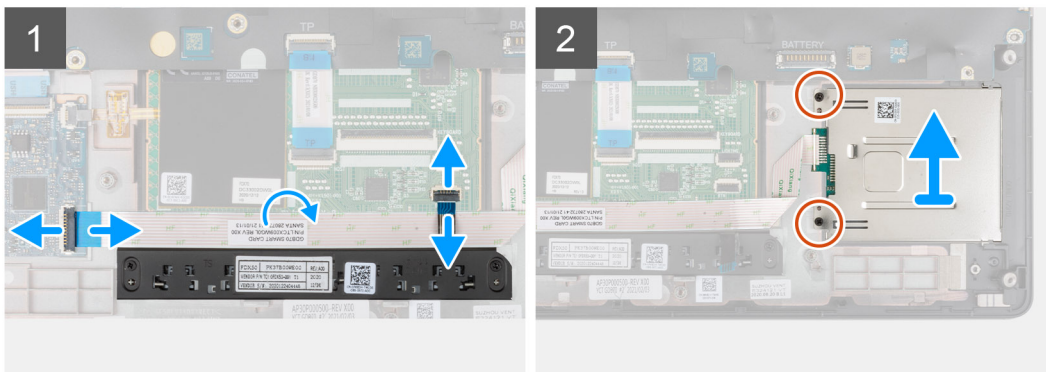
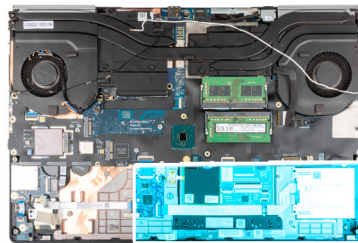

Steps

1. Disconnect the touchpad buttons FPC from the touchpad.
2. Disconnect the smart-card reader FFC from the connector on the USH daughter board.
3. Peel the smart-card reader FFC from the touchpad.
4. Remove the two (M2x2.5) screws that secure the smart-card reader to the computer.
5. Remove the smart-card reader from the computer.

Installing the smart-card reader

Prerequisites

If you are replacing a component, remove the existing component before performing the installation procedure.

About this task

The figure indicates the location of the smart-card reader and provides a visual representation of the installation procedure.



2x
M2x2.5

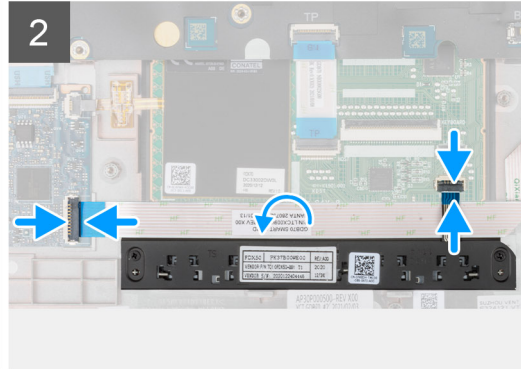
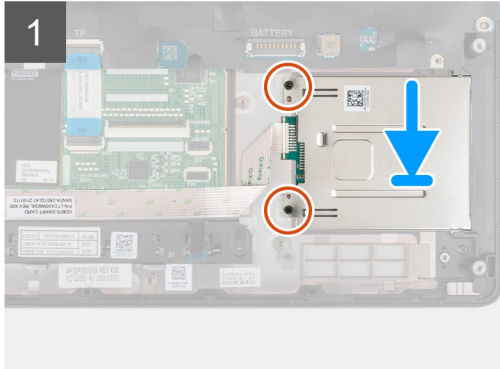
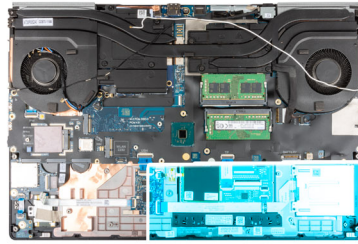

Steps

1. Align and place the smart-card reader into its slot on the computer.
2. Replace the two (M2x2.5) screws to secure the smart-card reader in place.
3. Adhere the smart-card reader FFC to the touchpad.
4. Connect the smart-card reader FFC to the connector on the USH daughter board.
5. Connect the touchpad button FPC to the connector on the touchpad.

Next steps

1. Install the [inner frame](#).
2. Install the [WWAN card](#).
3. Install the [WLAN card](#).
4. Install the [primary M.2 SSD](#).
5. Install the [battery](#).
6. Install the [base cover](#).
7. Install the [SD card](#).
8. Follow the procedure in [after working inside your computer](#).

Touchpad button

Removing the Touchpad buttons

Prerequisites

1. Follow the procedure in [before working inside your computer](#).
2. Remove the [SD card](#).
3. Remove the [base cover](#).
4. Remove the [battery](#).
5. Remove the [WLAN card](#).
6. Remove the [WWAN card](#).
7. Remove the [primary M.2 SSD](#).
8. Remove the [inner frame](#).

About this task

The figure indicates the location of the touchpad buttons and provides a visual representation of the removal procedure.



2x
M2x2.5

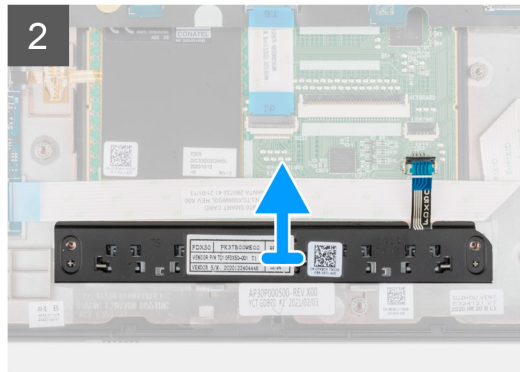
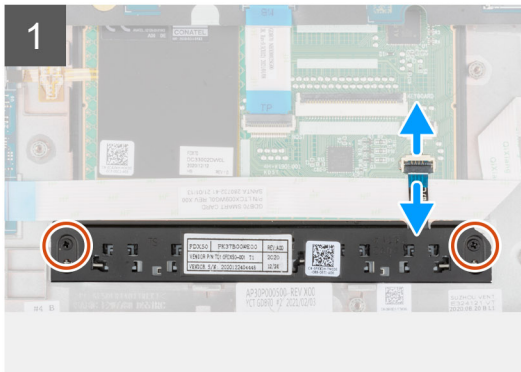
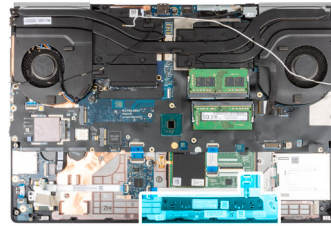

Steps

1. For models shipped with smart card reader, disconnect the smart card reader FFC from the USH daughter board and peel the smart card reader FFC from the touchpad.
2. Disconnect the touchpad buttons FPC from the connector on the touchpad.
3. Remove the two (M2x2.5) screws that secure the touchpad buttons to the palmrest.
4. Remove the touchpad buttons from the palmrest.

Installing the Touchpad buttons

Prerequisites

If you are replacing a component, remove the existing component before performing the installation procedure.

About this task

The figure indicates the location of the touchpad buttons and provides a visual representation of the installation procedure.



2x
M2x2.5

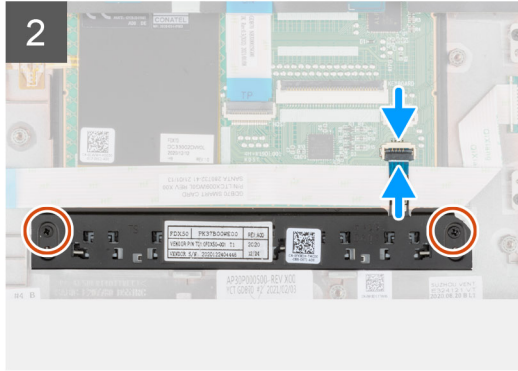
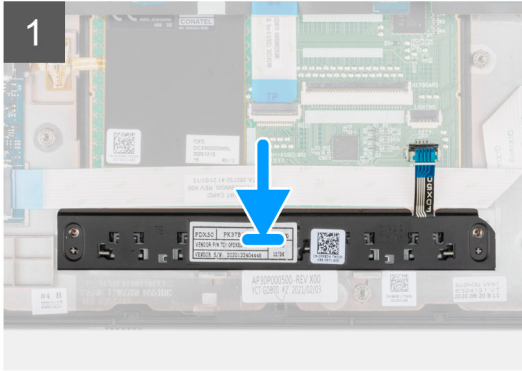
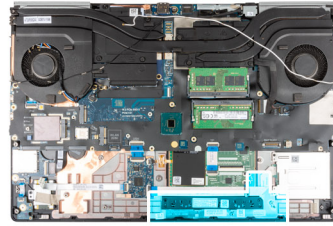

Steps

1. Place the touchpad buttons into its slot in the palmrest.
2. Replace the two (M2x2.5) screws to secure the touchpad buttons to the palmrest.
3. Connect the touchpad buttons FPC to the connector in the touchpad.
4. For models shipped with smart card reader, connect the smart card reader FFC to the USH daughter board and adhere the smart card reader FFC on the touchpad.

Next steps

1. Install the [inner frame](#).
2. Install the [WWAN card](#).
3. Install the [WLAN card](#).
4. Install the [primary M.2 SSD](#).
5. Install the [battery](#).
6. Install the [base cover](#).
7. Install the [SD card](#).
8. Follow the procedure in [after working inside your computer](#).

SD card reader

Removing SD card reader

Prerequisites

1. Follow the procedure in [before working inside your computer](#).
2. Remove the [SD card](#).
3. Remove the [base cover](#).
4. Remove the [battery](#).
5. Remove the [WLAN card](#).
6. Remove the [WWAN card](#).
7. Remove the [primary M.2 SSD](#).
8. Remove the [keyboard lattice](#).
9. Remove the [keyboard](#).
10. Remove the [inner frame](#).

About this task

The figure indicates the location of the SD card reader and provides a visual representation of the removal procedure.



1x
M2.5x2.5

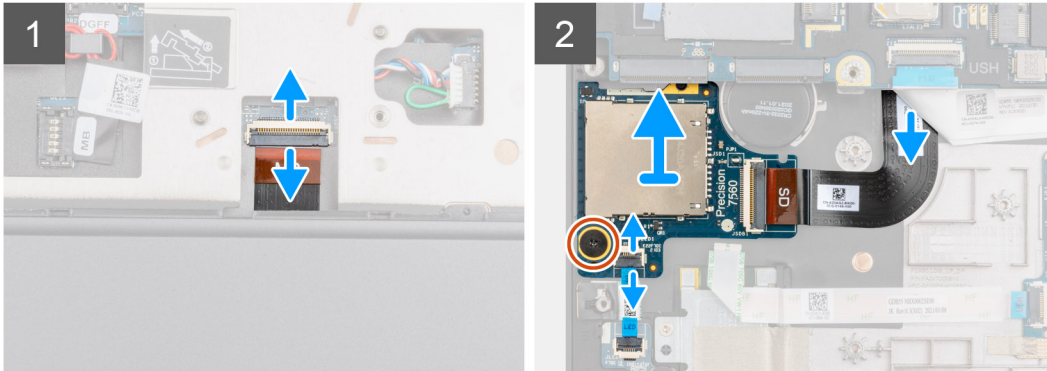
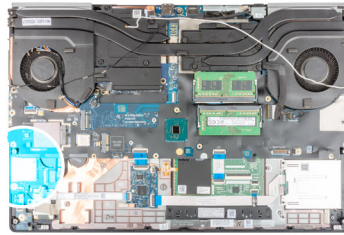

Steps

1. Disconnect the SD card reader FPC from the connector on the system board.
2. Turn the computer and disconnect the LED board FFC from the SD card reader on the bottom side of the computer.
3. Remove the (M2.5x2.5) screw that secures the SD card reader in place.
4. Slide and remove the SD card reader with its FPC out of the computer.

Installing SD card reader

Prerequisites

If you are replacing a component, remove the existing component before performing the installation procedure.

About this task

The figure indicates the location of the SD card reader and provides a visual representation of the installation procedure.



1x
M2.5x2.5

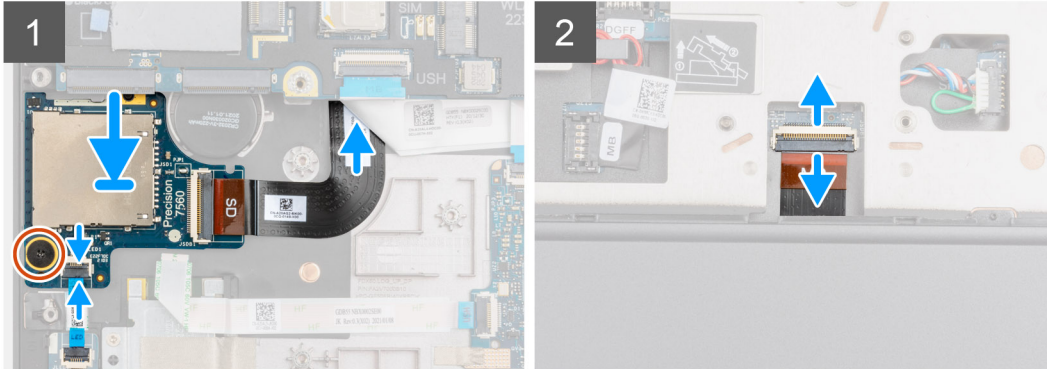
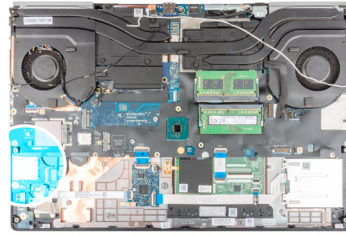

Steps

1. Align the SD card reader with the FPC into its slot on the palmrest.
2. Place the SD card reader with the FPC on the palmrest and route the SD card reader FPC through the opening in the palmrest.
3. Replace the (M2.5x2.5) screw to secure the SD card reader to the palmrest.
4. Connect the LED board FPC to the SD card reader.
5. Turn the computer and connect the SD card reader FPC to the connector on the system board.

Next steps

1. Install the [inner frame](#).
2. Install the [keyboard](#).
3. Install the [keyboard lattice](#).
4. Install the [WWAN card](#).
5. Install the [WLAN card](#).
6. Install the [primary M.2 SSD](#).
7. Install the [battery](#).
8. Install the [base cover](#).
9. Install the [SD card](#).
10. Follow the procedure in [after working inside your computer](#).

Heat sink

Removing the heat-sink assembly

Prerequisites

1. Follow the procedure in [before working inside your computer](#).
2. Remove the [SD card](#).
3. Remove the [base cover](#).
4. Remove the [battery](#).

About this task

The figure indicates the location of the heat-sink assembly and provides a visual representation of the removal procedure.

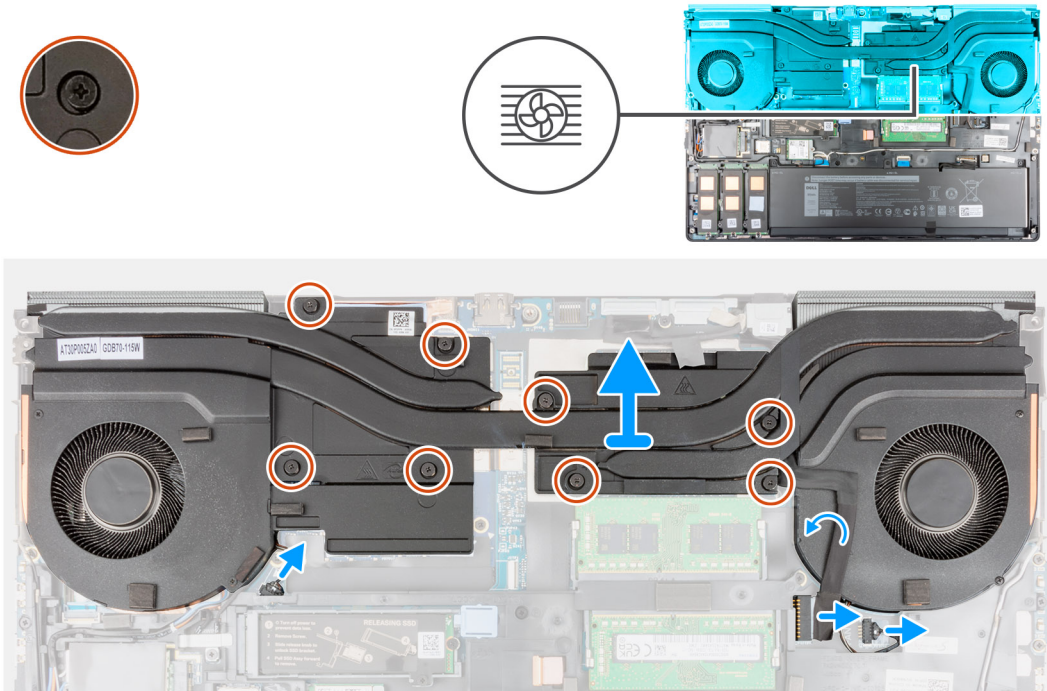

Steps

1. Disconnect the power-adaptor cable and peel the cable from the heat-sink assembly.
2. Disconnect the two fan cables from the connectors on the system board.
3. For the computers shipped with UMA graphics card:
 - a. Loosen the four captive screws that secure the heat-sink assembly to the system board.
 - i** **NOTE:** Loosen the captive screws in the order stamped onto the heat-sink assembly next to the screws [4 > 3 > 2 > 1].
4. For the computers shipped with discrete graphics card:
 - a. Loosen the eight captive screws that secure the heat-sink assembly to the system board.
 - i** **NOTE:** Loosen the captive screws in the order stamped onto the heat-sink assembly next to the screws [8 > 7 > 6 > 5 > 4 > 3 > 2 > 1].
5. Carefully lift the heat-sink assembly to remove it from the computer.
 - i** **NOTE:** While lifting the heat-sink assembly, the thermal pads attached to the bottom side of the heat sink can stick to the computer and can cause only one side to lift. As the heat sink thermal tube is thin and can bend easily, ensure to evenly lift the heat-sink assembly and not from one side.
 - i** **NOTE:** If any thermal pads attached to the bottom side of the heat-sink assembly are detached while removing the heat-sink assembly, adhere them back to their correct location on the heat sink.

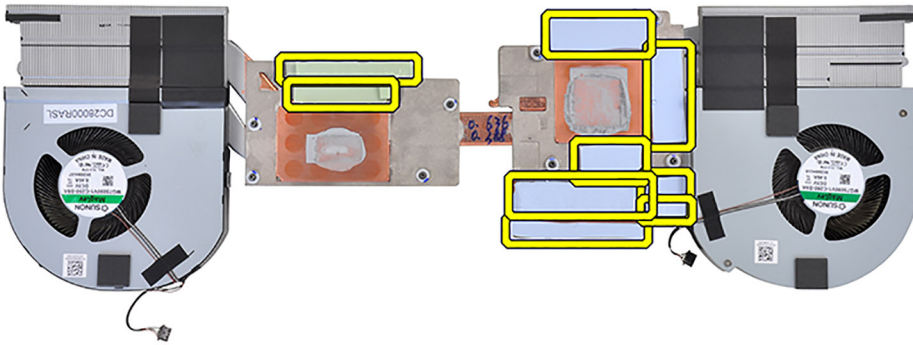

NOTE: For the computers shipped with UMA graphics card, the thermal pads will be shown on the left half of the heat-sink assembly.

Installing the heat-sink assembly

Prerequisites

If you are replacing a component, remove the existing component before performing the installation procedure.

About this task

The figure indicates the location of the keyboard and provides a visual representation of the installation procedure.

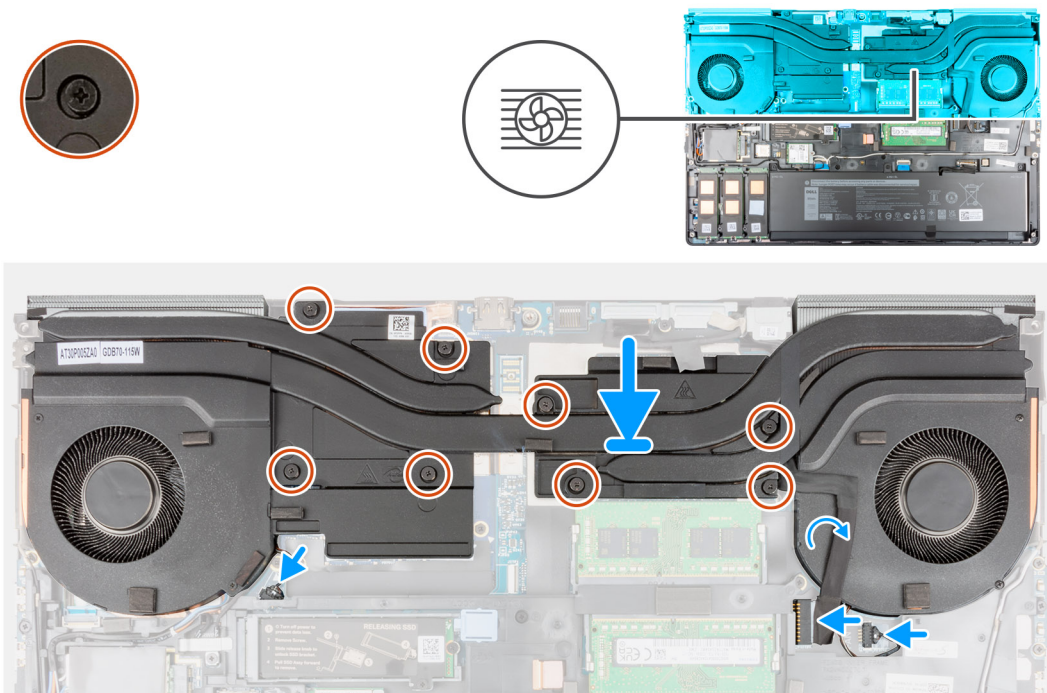

Steps

1. Align and insert the heat-sink assembly into its slot on the computer.
2. For the computers shipped with UMA graphics card:
 - a. Tighten the four captive screws to secure the heat-sink assembly to the system board.
i **NOTE:** Tighten the captive screws in the order stamped onto the heat sink next to the screws [1 > 2 > 3 > 4].
3. For the computers shipped with discrete graphics card:
 - a. Tighten the eight captive screws to secure the heat-sink assembly to the system board.
i **NOTE:** Tighten the captive screws in the order stamped onto the heat sink next to the screws [1 > 2 > 3 > 4 > 5 > 6 > 7 > 8].
4. Connect the two fan cables to the connector on the system board.
5. Adhere the power-adaptor cable on the heat-sink assembly.
6. Connect the power-adaptor cable to the connector on the system board.

Next steps

1. Install the [battery](#).
2. Install the [base cover](#).
3. Install the [SD card](#).
4. Follow the procedure in [after working inside your computer](#).

Power button board

Removing the power button board

Prerequisites

1. Follow the procedure in [before working inside your computer](#).
2. Remove the [SD card](#).
3. Remove the [base cover](#).
4. Remove the [battery](#).
5. Remove the [heat-sink assembly](#).

About this task

The figure indicates the location of the power button board and provides a visual representation of the removal procedure.



2x
M2x3

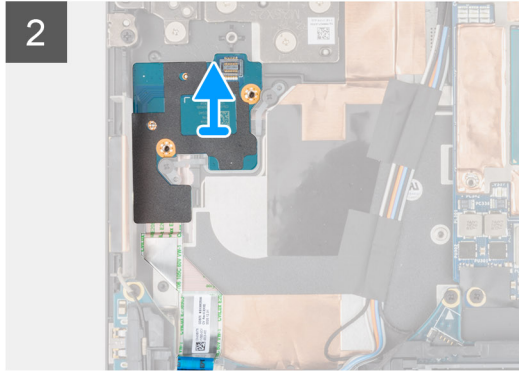
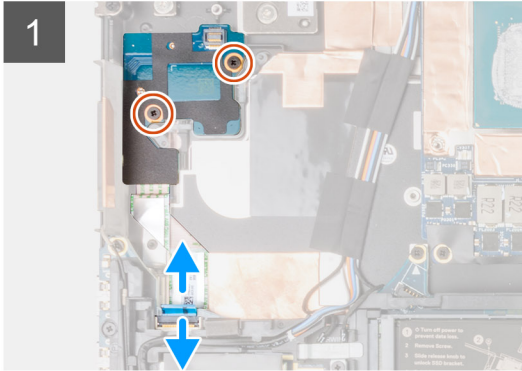
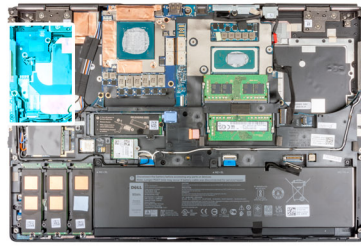

Steps

1. Disconnect the power button board FFC from the connector on the system board.
2. Peel the power button board FFC from the palmrest.
3. Remove the two (M2x3) screws that secure the power button board to the computer.
4. Remove the power button board with the power button board FFC from the computer.
5. Disconnect the power button board FFC from the power button board.

Installing the power button board

Prerequisites

If you are replacing a component, remove the existing component before performing the installation procedure.

About this task

The figure indicates the location of the power button board and provides a visual representation of the installation procedure.



2x
M2x3

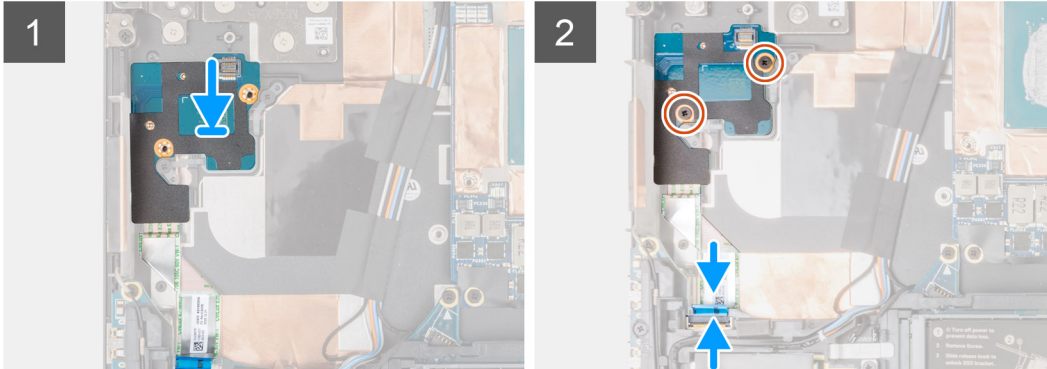
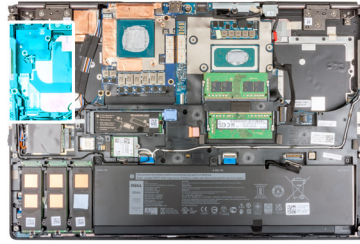

Steps

1. Connect the power button board FFC to the power button board.
2. Align and place the power button board with the power button FFC into its slot on the computer.
3. Replace the two (M2x3) screws to secure the power button board to the computer.
4. Adhere the power button board FFC to the palmrest.
5. Connect the power button board FFC to the connector on the system board.

Next steps

1. Install the [heat-sink assembly](#).
2. Install the [battery](#).
3. Install the [base cover](#).
4. Install the [SD card](#).
5. Follow the procedure in [after working inside your computer](#).

Power button board with fingerprint reader

Removing the power button board assembly with fingerprint reader

Prerequisites

1. Follow the procedure in [before working inside your computer](#).
2. Remove the [SD card](#).
3. Remove the [base cover](#).
4. Remove the [battery](#).
5. Remove the [heat-sink assembly](#).

About this task

The figure indicates the location of the power button board assembly with fingerprint reader and provides a visual representation of the removal procedure.



3x
M2x3

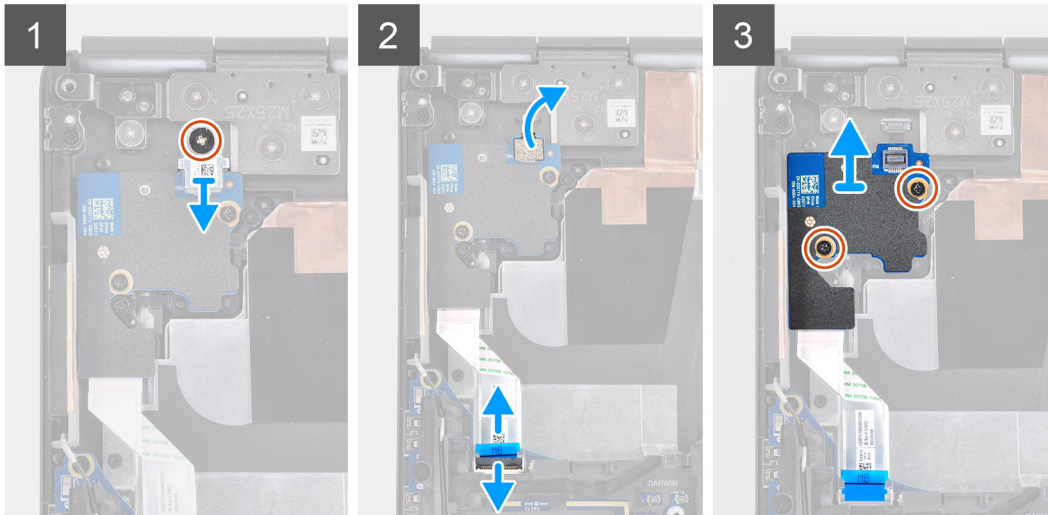
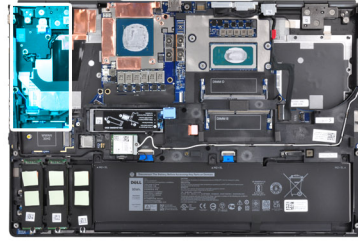

Steps

1. Remove the (M2x3) screw that secures the power button board assembly with fingerprint reader FPC bracket to the power button board.
2. Remove the power button board assembly with fingerprint reader FPC bracket from the power button board.
3. Disconnect the power button board assembly with fingerprint reader FPC from the power button board.
4. Disconnect the power button board FFC from the connector on the system board.
5. Peel the power button board FFC from the palmrest.
6. Remove the two (M2x3) screws that secure the power button board to the computer.
7. Remove the power button board with the power button board FFC from the computer.
8. Disconnect the power button board FFC from the power button board.

Installing the power button board assembly with fingerprint reader

Prerequisites

If you are replacing a component, remove the existing component before performing the installation procedure.

About this task

The figure indicates the location of the power button assembly with fingerprint reader and provides a visual representation of the installation procedure.



3x
M2x3

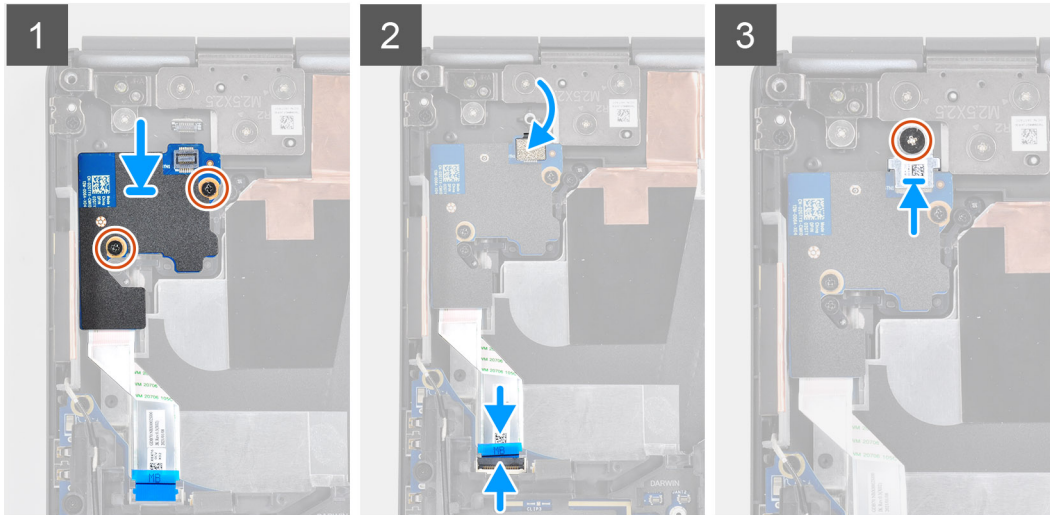
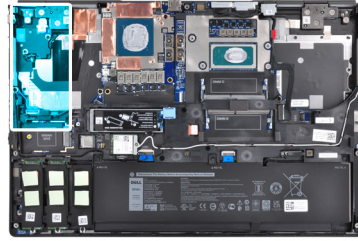

Steps

1. Connect the power button board FFC to the power button board.
2. Align and place the power button board with power button FFC into its slot on the computer.
3. Replace the two (M2x3) screws to secure the power button board to the computer.
4. Adhere the power button board FFC to the palmrest.
5. Connect the power button board FFC to the connector on the system board.
6. Connect the power button board assembly with fingerprint reader FPC to the power button board.
7. Replace the power button board assembly with fingerprint reader FPC bracket above the power button daughter board.
8. Replace the (M2x3) screw to secure the power button board assembly with fingerprint reader FPC bracket in place.

Next steps

1. Install the [heat-sink assembly](#).
2. Install the [battery](#).
3. Install the [base cover](#).
4. Install the [SD card](#).
5. Follow the procedure in [after working inside your computer](#).

Power button

Removing the power button

Prerequisites

1. Follow the procedure in [before working inside your computer](#).
2. Remove the [SD card](#).
3. Remove the [base cover](#).
4. Remove the [battery](#).
5. Remove the [heat-sink assembly](#).

6. Remove the [power button board](#).

About this task

The figure indicates the location of the power button and provides a visual representation of the removal procedure.



2x
M2x3

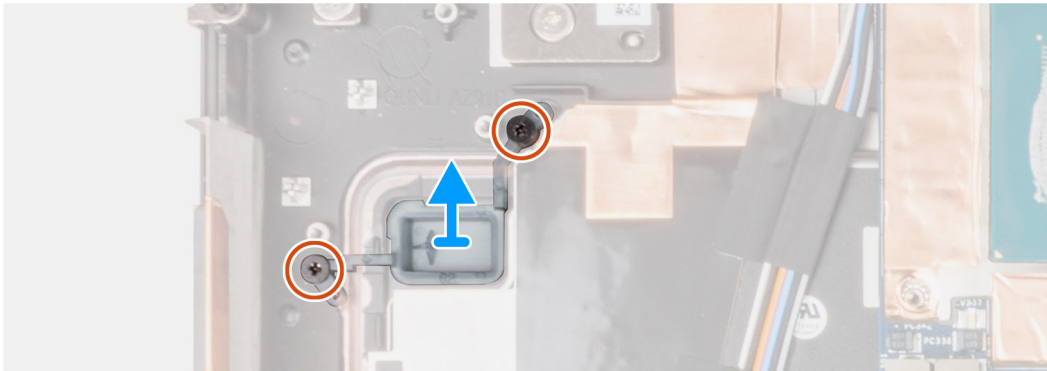
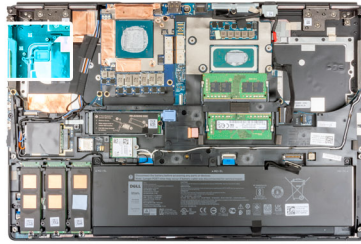

Steps

1. Remove the two (M2x3) screws that secure the power button in its slot on the computer.
2. Remove the power button from the computer.

Installing the power button

Prerequisites

If you are replacing a component, remove the existing component before performing the installation procedure.

About this task

The figure indicates the location of the power button and provides a visual representation of the installation procedure.



2x
M2x3

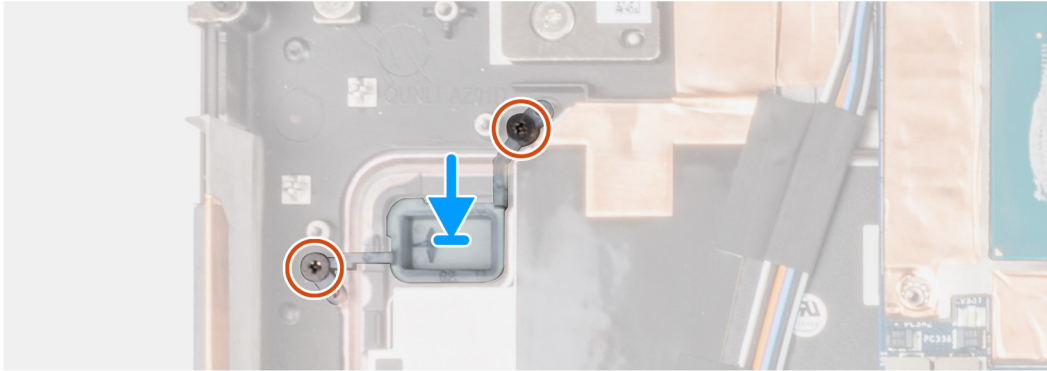
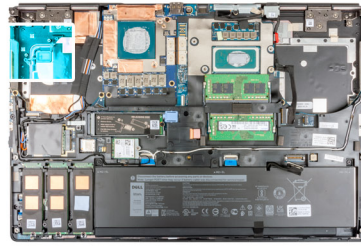

Steps

1. Place the power button into its slot on the computer.
2. Replace the two (M2x3) screws to secure the power button in place.

Next steps

1. Install the [power button board](#).
2. Install the [heat-sink assembly](#).
3. Install the [battery](#).
4. Install the [base cover](#).
5. Install the [SD card](#).
6. Follow the procedure in [after working inside your computer](#).

Power button assembly with fingerprint reader

Removing the power button board assembly with fingerprint reader

Prerequisites

1. Follow the procedure in [before working inside your computer](#).
2. Remove the [SD card](#).
3. Remove the [base cover](#).
4. Remove the [battery](#).
5. Remove the [heat-sink assembly](#).

About this task

The figure indicates the location of the power button board assembly with fingerprint reader and provides a visual representation of the removal procedure.



3x
M2x3

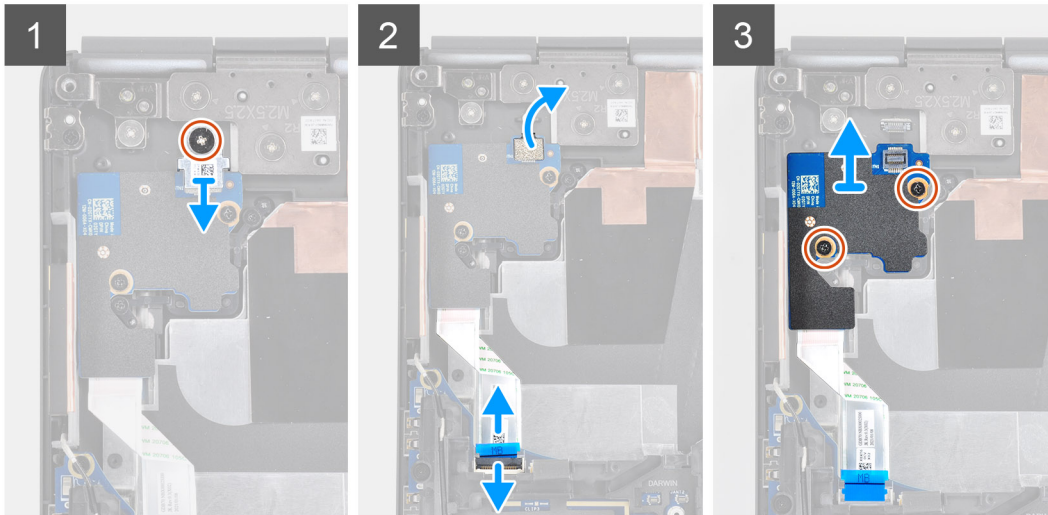
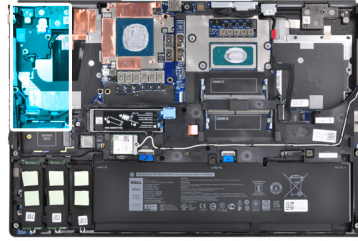

Steps

1. Remove the (M2x3) screw that secures the power button board assembly with fingerprint reader FPC bracket to the power button board.
2. Remove the power button board assembly with fingerprint reader FPC bracket from the power button board.
3. Disconnect the power button board assembly with fingerprint reader FPC from the power button board.
4. Disconnect the power button board FFC from the connector on the system board.
5. Peel the power button board FFC from the palmrest.
6. Remove the two (M2x3) screws that secure the power button board to the computer.
7. Remove the power button board with the power button board FFC from the computer.
8. Disconnect the power button board FFC from the power button board.

Installing the power button assembly with fingerprint reader

Prerequisites

If you are replacing a component, remove the existing component before performing the installation procedure.

About this task

The figure indicates the location of the power button assembly with fingerprint reader and provides a visual representation of the installation procedure.



2x
M2x3

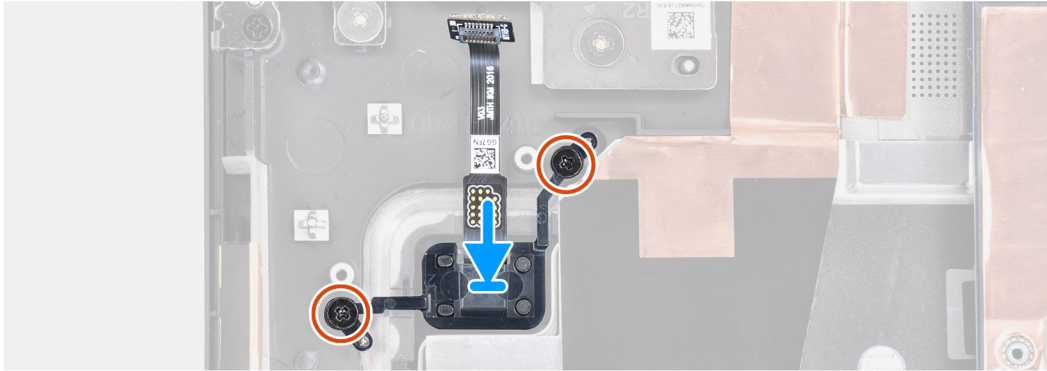
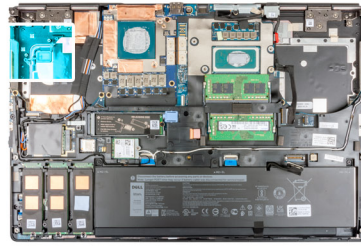

Steps

1. Place the power button assembly with fingerprint reader into its slot on the computer.
2. Replace the two (M2x3) screws to secure the power button assembly with fingerprint reader in place.

Next steps

1. Install the [power button board assembly with fingerprint reader](#).
2. Install the [heat-sink assembly](#).
3. Install the [battery](#).
4. Install the [base cover](#).
5. Install the [SD card](#).
6. Follow the procedure in [after working inside your computer](#).

GPU power cable

Removing the GPU power cable

Prerequisites

1. Follow the procedure in [before working inside your computer](#).
2. Remove the [SD card](#).
3. Remove the [base cover](#).
4. Remove the [battery](#).
5. Remove the [keyboard lattice](#).
6. Remove the [keyboard](#).

About this task

The figure indicates the location of the GPU power cable and provides a visual representation of the removal procedure.

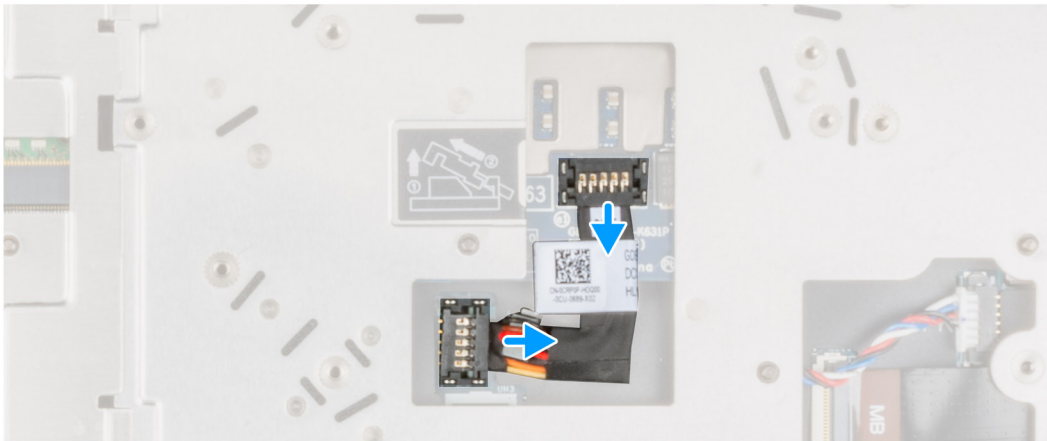

Steps

1. Carefully pry the outside end of the GPU power cable connector head to unlock the GPU power cable connector from the GPU card.
2. Slightly slide the GPU power cable connector outwards to disconnect the GPU power cable from the GPU card.
3. Repeat the above steps to disconnect the GPU power cable from the system board.
4. Peel the GPU power cable from the computer.

Installing the GPU power cable

Prerequisites

If you are replacing a component, remove the existing component before performing the installation procedure.

About this task

The figure indicates the location of the GPU power cable and provides a visual representation of the installation procedure.

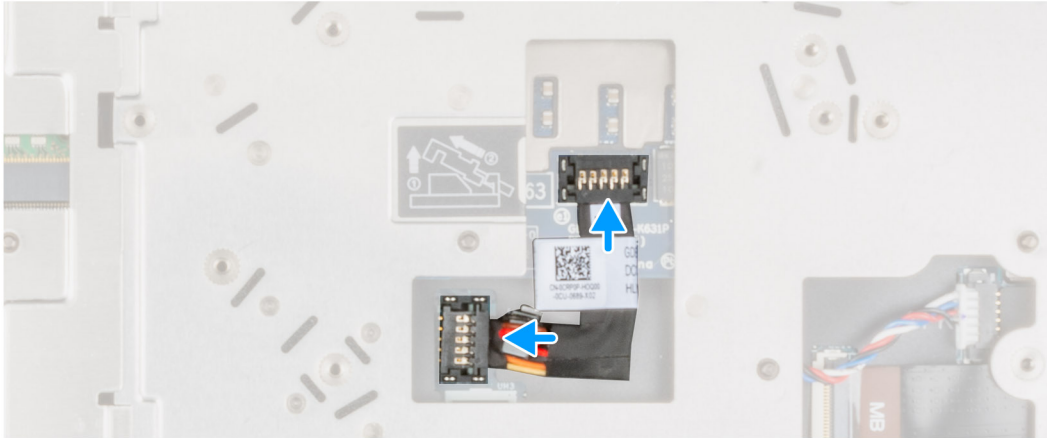

Steps

1. Adhere the GPU power cable into its slot on the computer.
2. Disconnect the GPU power cable from the connector on the system board.
3. Slide the GPU power cable connector into its slot to connect the GPU power cable to the GPU card.
4. Lock the GPU power cable connector to secure the GPU card.

Next steps

1. Install the [keyboard](#).
2. Install the [keyboard lattice](#).
3. Install the [battery](#).
4. Install the [base cover](#).
5. Install the [SD card](#).
6. Follow the procedure in [after working inside your computer](#).

System board

Removing the system board

Prerequisites

1. Follow the procedure in [before working inside your computer](#).
2. Remove the [SD card](#).
3. Remove the [secondary M.2 SSD](#).
4. Remove the [base cover](#).
5. Remove the [battery](#).
6. Remove the [SIM card](#).
7. Remove the [secondary memory](#).
8. Remove the [WLAN card](#).
9. Remove the [WWAN card](#).
10. Remove the [primary M.2 SSD](#).
11. Remove the [keyboard lattice](#).

12. Remove the [keyboard](#).
13. Remove the [primary memory](#).
14. Remove the [heat-sink assembly](#).
15. Remove the [inner frame](#).

About this task

The figure indicates the location of the system board and provides a visual representation of the removal procedure.

The following image indicates the connectors on your system board:

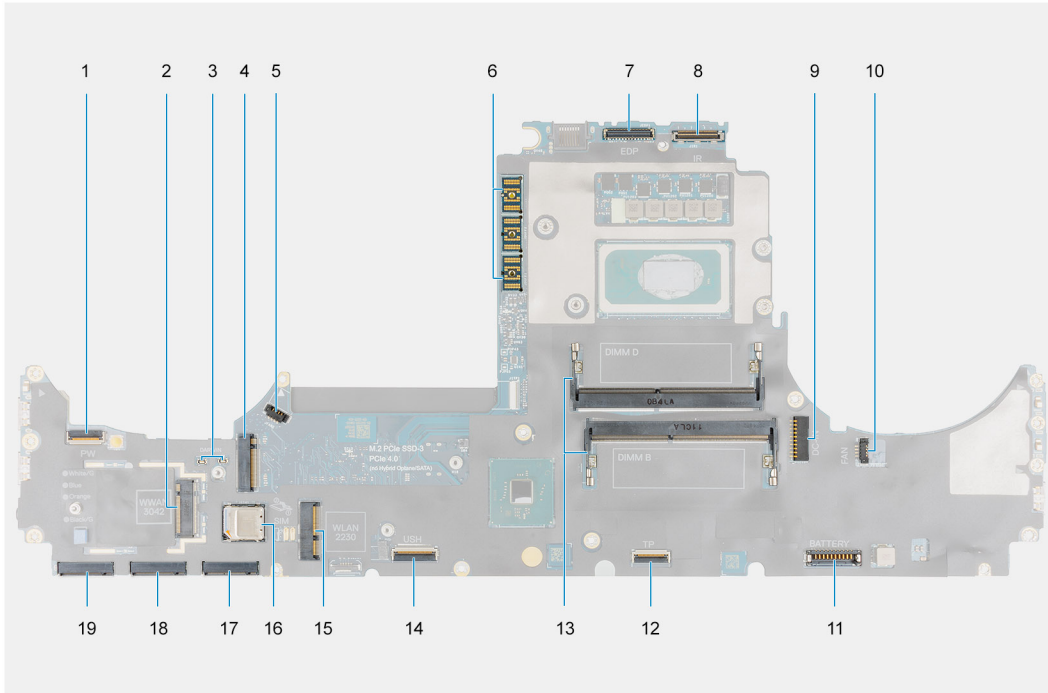

1. Power button FFC connector
2. WWAN card connector
3. Darwin antenna cable connector
4. Secondary M.2 SSD connector
5. Fan cable connector
6. FPC beam connector
7. Display cable connector
8. IR camera/Touchscreen cable connector
9. Power-adaptor port connector
10. Fan cable connector
11. Battery cable connector
12. Touchpad cable connector
13. Secondary memory module slot
14. USB daughter board cable connector
15. WLAN card connector
16. SIM card slot
17. Primary M.2 SSD slot 3 connector
18. Primary M.2 SSD slot 4 connector
19. Primary M.2 SSD slot 5 connector

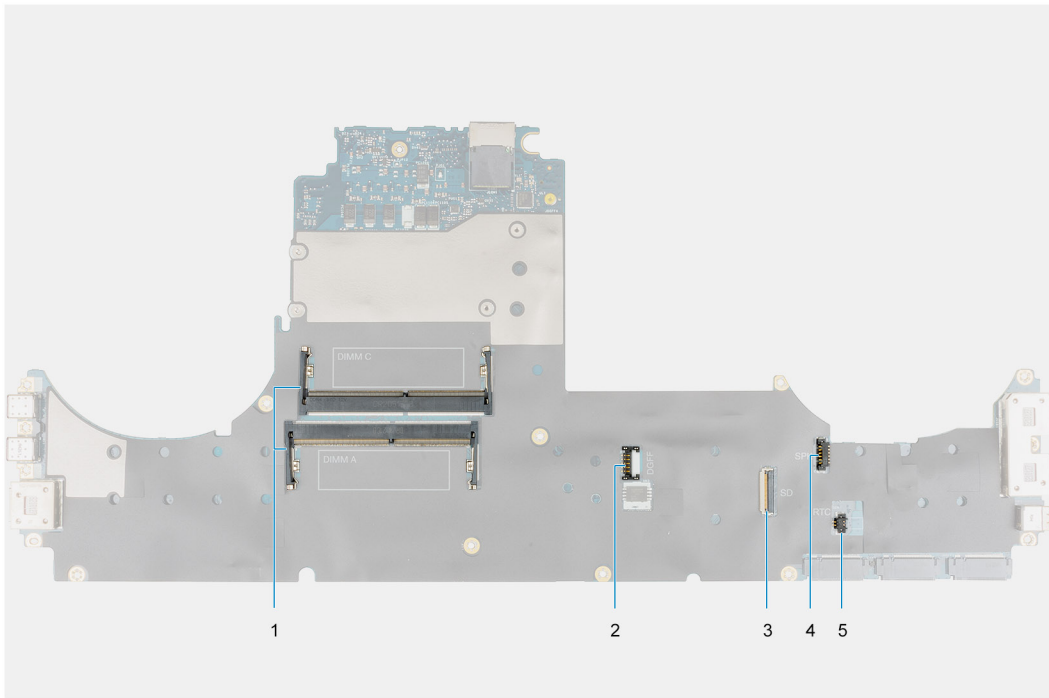

1. Primary memory module slot
2. GPU power cable connector
3. SD card reader cable
4. Speaker cable connector
5. Coin-cell battery cable connector

i **NOTE:** For models shipped with a discrete GPU card:



4x
M2x3

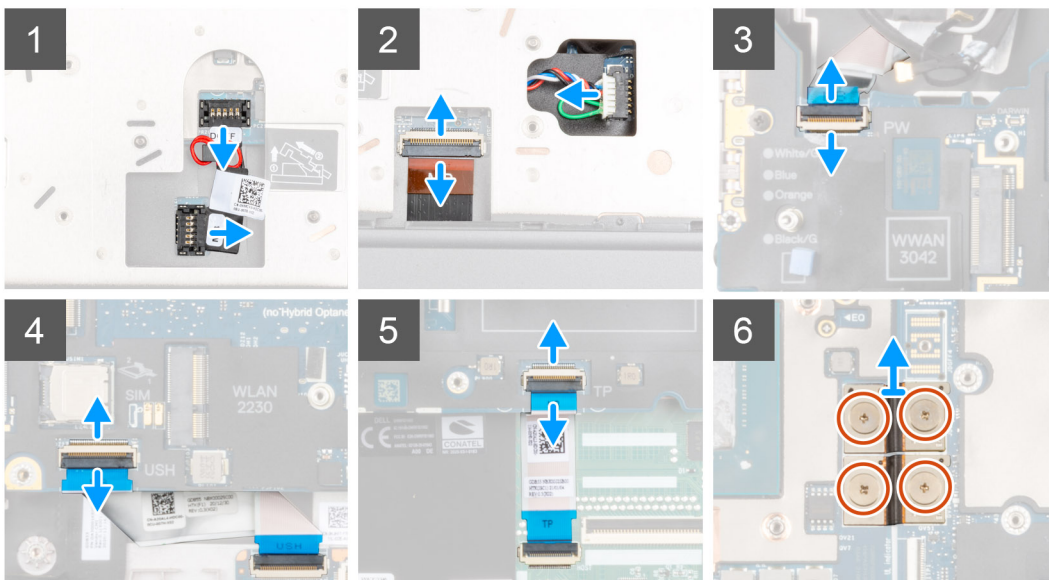
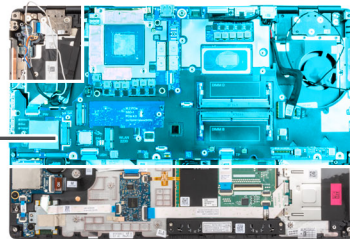



5x
M2x5

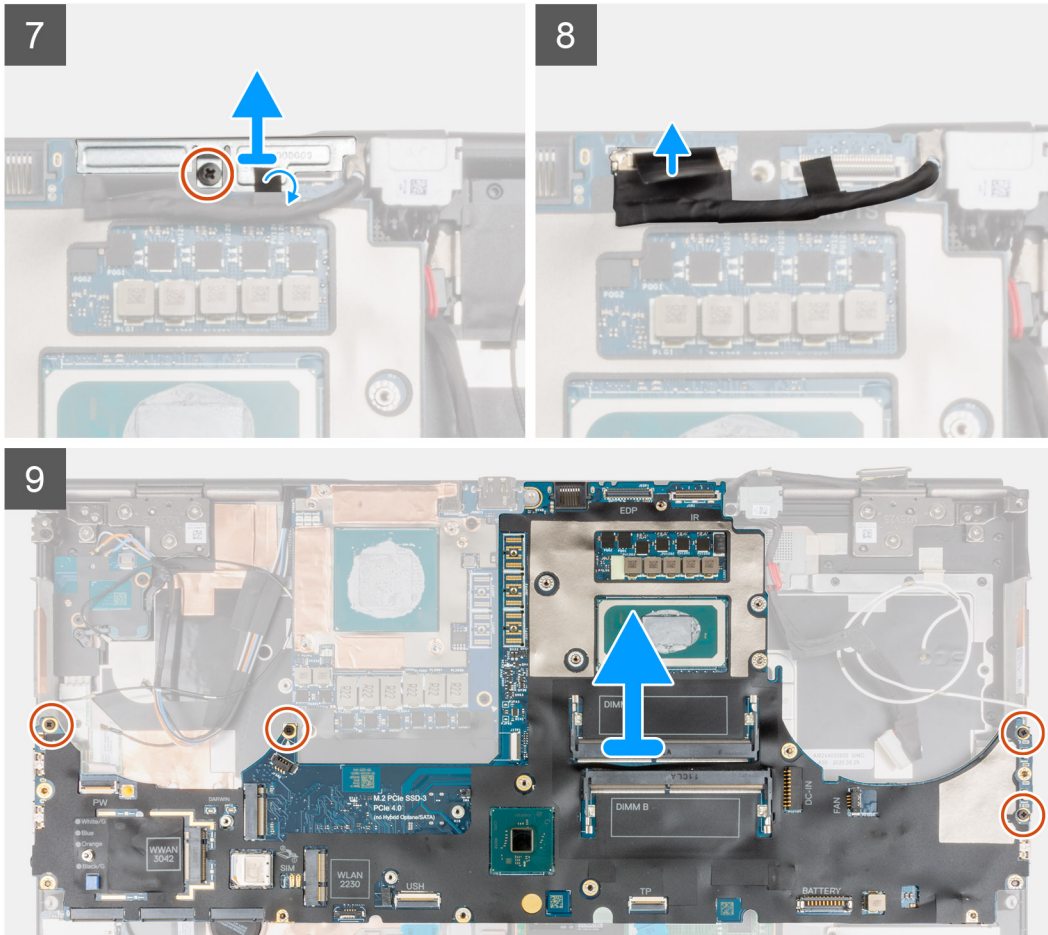

Steps

1. Carefully pry the outside end of the GPU power cable connector head to unlock the GPU power cable connector from the system board on top side of the system.
2. Slightly slide the GPU power cable connector outwards to disconnect the GPU power cable from the connector on the system board.
3. Disconnect the speaker cable and the SD card reader FPC from the connectors on the system board.
4. Disconnect the touch screen cable (for models shipped with a touch screen) or IR camera cable (for models shipped with an IR camera), power adapter cable, touchpad FFC, USH daughter board FFC (for models shipped with a USH daughter board), and power button board FFC from the system board.
5. Remove the four (M2x3) screws that secure the two FPC beam connectors to the system board and the GPU card.
i **NOTE:** For computers shipped with a UMA GPU card, remove the two (M2x3) screws that secure the single FPC beam connector to the system board and the GPU card.
6. Remove the FPC beam connectors from the computer.
7. Remove the (M2x5) screw that secures the display cable bracket in place.
8. Remove the display cable bracket from the computer.
9. Disconnect the display cable from the connector on the system board.
10. Remove the four (M2x5) screws that secure the system board to the computer.

11. Pry the coin-cell battery, located under the system board, from the palmrest while lifting the system board.

i **NOTE:** When replacing the system board, the Type-C bracket on the left side under the system board must be relocated to the replacement system board.

i **NOTE:** If the Type-C bracket becomes detached from the system board anytime after the system board is removed from the computer, re-adhere the bracket onto the system board.

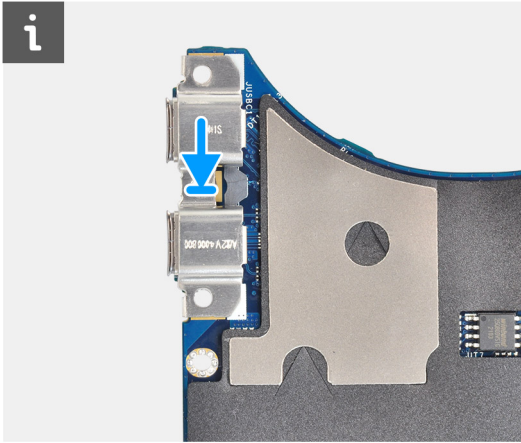

12. Remove the system board from the computer.

Installing the system board

Prerequisites

If you are replacing a component, remove the existing component before performing the installation procedure.

About this task

The figure indicates the location of the system board and provides a visual representation of the installation procedure.



5x
M2x5

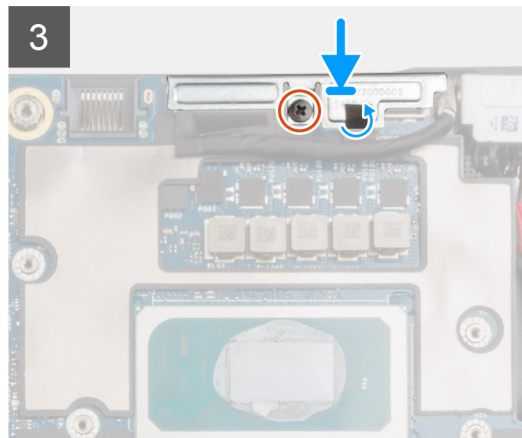
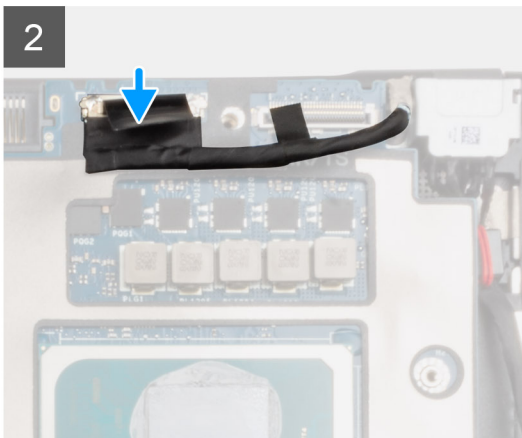
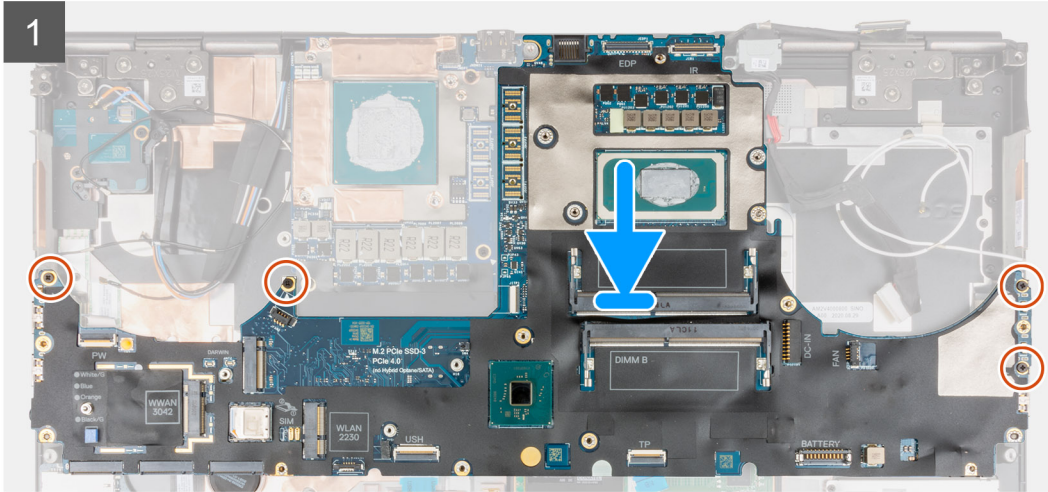
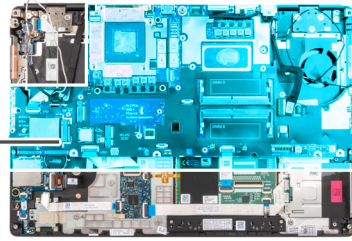



4x
M2x3

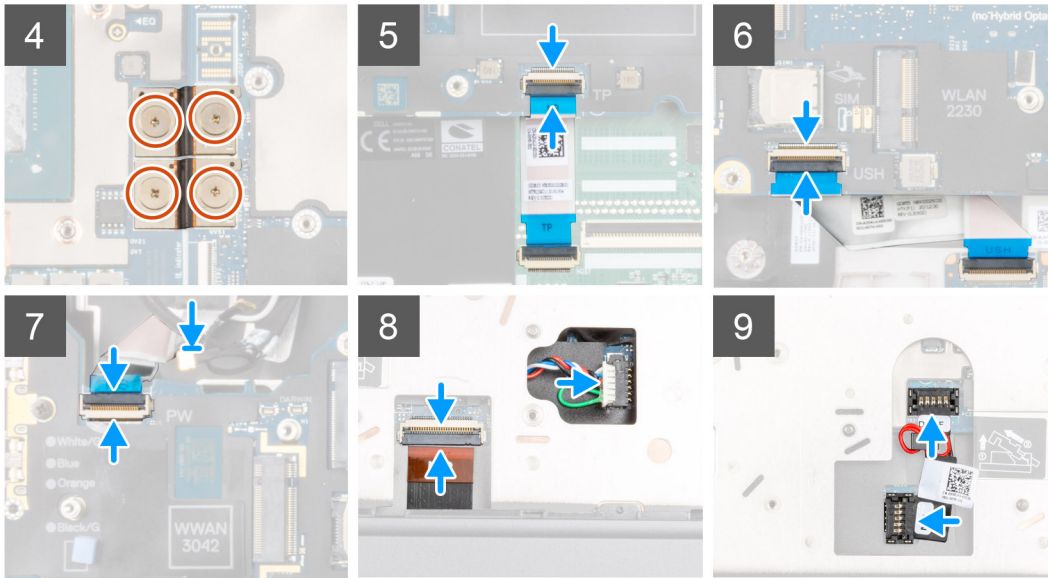

Steps

1. **NOTE:** When replacing the system board, the Type-C bracket on the left side, under the system board must be relocated to the replacement system board.

Adhere the coin-cell battery to the palmrest and then place the system board on its slot on the palmrest.

2. Replace the four (M2x5) screws to secure the system board to the palmrest.
3. Replace the display cable bracket on the display cable.
4. Replace the (M2x5) screw to secure the display cable bracket to the system board.
5. Connect the FPC beam connectors on the system board.
NOTE: When installing an FPC beam connector, ensure that the end marked "MB" is connected to the system board and that the alignment pins on the connector are inserted into the openings on the boards.
6. Replace the four (M2x3) screws to secure the two FPC beam connectors to the system board and the GPU card.
NOTE: For UMA models, replace the two (M2x3) screws to secure the single FPC beam connector to the system board and the GPU card.
NOTE: When installing an FPC beam connector, ensure that the end marked "MB" is connected to the system board and that the alignment pins on the connector are inserted into the openings on the boards.
7. Connect the speaker cable and SD card reader FPC to the connectors on the system board.
8. Connect the display cable, touch screen cable (for models shipped with a touch screen) or IR camera cable (for models shipped with an IR camera), power adapter cable, touchpad FPC, USH daughter board FFC (for models shipped with a USH daughter board), and power button board FFC to the connectors on the system board.
9. Connect the GPU power cable to the connector on the system board on the top side of the computer.
10. Lock the GPU power cable connector on the system board.

Next steps

1. Install the [inner frame](#).
2. Install the [heat-sink assembly](#).

3. Install the [keyboard](#).
4. Install the [keyboard lattice](#).
5. Install the [SIM card](#).
6. Install the [primary memory](#).
7. Install the [WWAN card](#).
8. Install the [WLAN card](#).
9. Install the [secondary memory](#).
10. Install the [primary M.2 SSD](#).
11. Install the [battery](#).
12. Install the [base cover](#).
13. Install the [secondary M.2 SSD](#).
14. Install the [SD card](#).
15. Follow the procedure in [after working inside your computer](#).

Power-adapter port

Removing the power-adapter port

Prerequisites

1. Follow the procedure in [before working inside your computer](#).
2. Remove the [SD card](#).
3. Remove the [base cover](#).
4. Remove the [heat-sink assembly](#).

About this task

The figure indicates the location of the power-adapter port and provides a visual representation of the removal procedure.

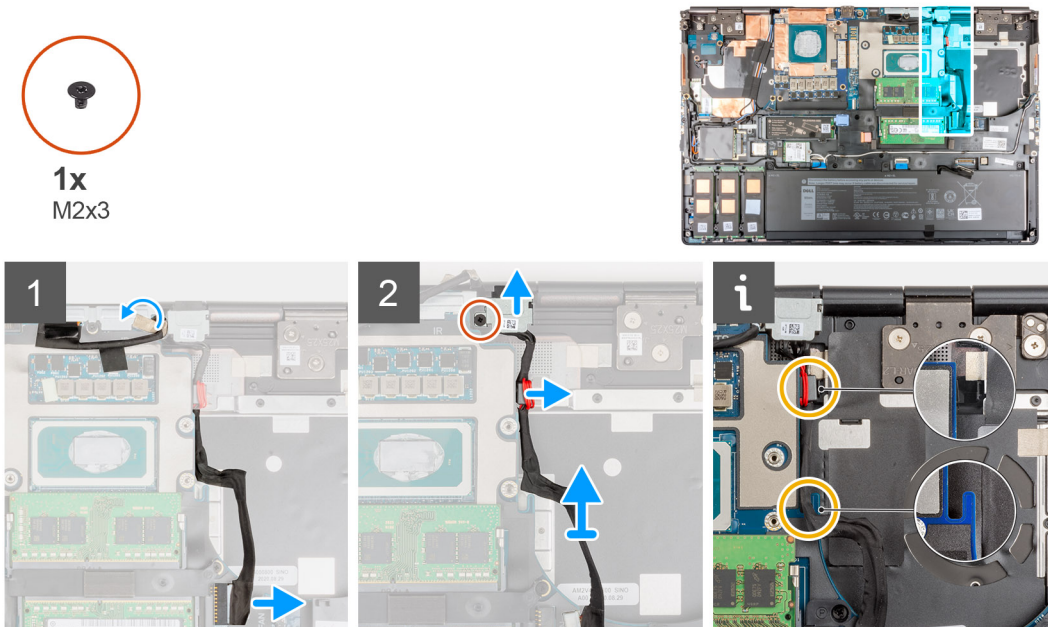

Steps

1. Disconnect the power-adapter cable from the connector on the system board.
2. Peel and unroute the display cable from the route to access the power-adapter port slot.
3. Remove the (M2x3) screw that secures power-adapter port bracket.
4. Remove the power-adapter port bracket from the computer.

5. Unroute the power-adapter cable from the cut-out on the system board and lift the cable clamp from the computer chassis.
6. Slide the power-adapter port towards the rear side of the computer to remove the power-adapter port from its compartment on the computer chassis.

Installing the power-adapter port

Prerequisites

If you are replacing a component, remove the existing component before performing the installation procedure.

About this task

The figure indicates the location of the power-adapter port and provides a visual representation of the installation procedure.

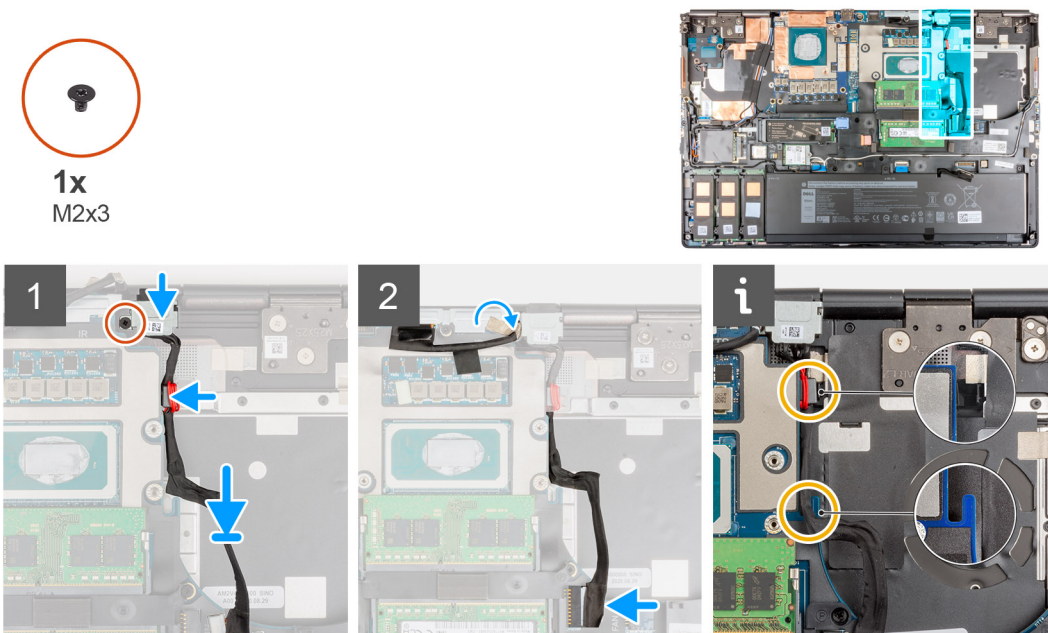

Steps

1. Align and place the power-adapter cable on the computer.
2. Place the power-adapter port into its compartment on the computer chassis.
3. Firmly place the cable clamp into its compartment on the computer chassis and route the power-adapter cable through the cut-out on the system board.
4. Place the power-adapter port bracket on the power-adapter port.
5. Replace the (M2x3) screw to secure the power-adapter port bracket to the computer.
6. Connect the power-adapter cable to the connector on the system board.
7. Adhere and route the display cable in place.

Next steps

1. Install the [heat-sink assembly](#).
2. Install the [base cover](#).
3. Install the [SD card](#).
4. Follow the procedure in [after working inside your computer](#).

GPU card

Removing the GPU card

Prerequisites

1. Follow the procedure in [before working inside your computer](#).
2. Remove the [SD card](#).
3. Remove the [secondary M.2 SSD](#).
4. Remove the [base cover](#).
5. Remove the [battery](#).
6. Remove the [SIM card](#).
7. Remove the [secondary memory](#).
8. Remove the [WLAN card](#).
9. Remove the [WWAN card](#).
10. Remove the [primary M.2 SSD](#).
11. Remove the [keyboard lattice](#).
12. Remove the [keyboard](#).
13. Remove the [GPU power cable](#).
14. Remove the [primary memory](#).
15. Remove the [heat-sink assembly](#).
16. Remove the [inner frame](#).

About this task

The figure indicates the location of the GPU card and provides a visual representation of the removal procedure.



3x
M2x5

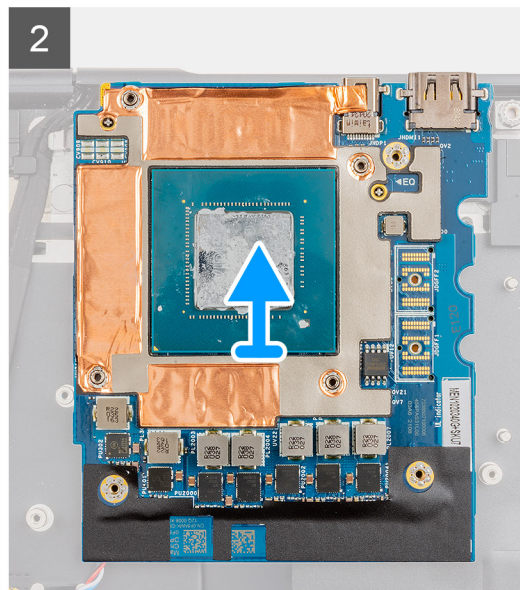
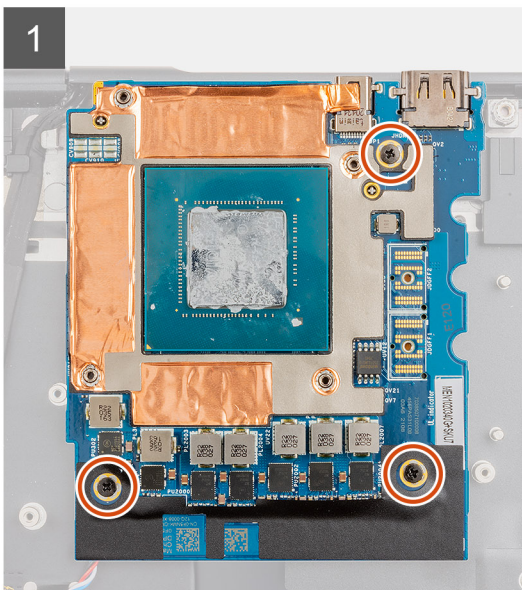
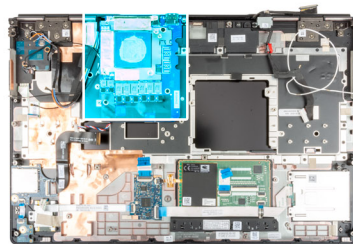

Steps

1. Remove the three (M2x5) screws that secure the GPU card to the palmrest.
2. Remove the GPU card from the computer.

Installing the GPU card

Prerequisites

If you are replacing a component, remove the existing component before performing the installation procedure.

About this task

The figure indicates the location of the GPU card and provides a visual representation of the installation procedure.



3x
M2x5

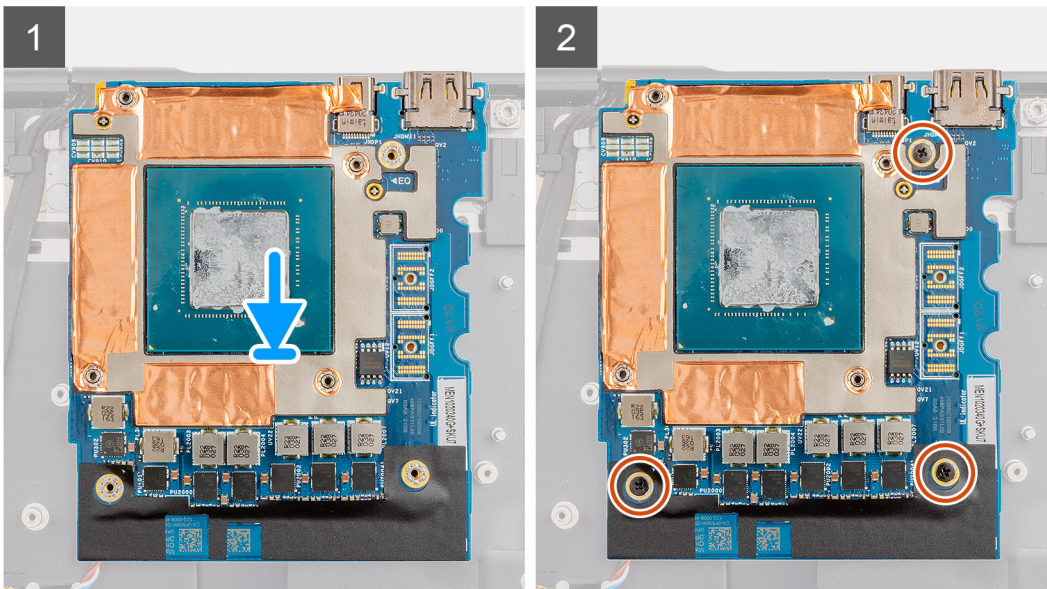
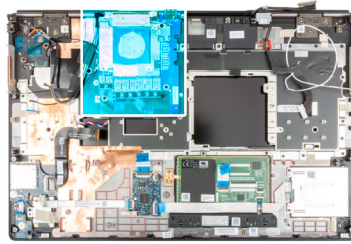

Steps

1. Align and place the GPU card into its slot on the palmrest.
2. Replace the three (M2x5) screws to secure the GPU card to the palmrest.
 - NOTE:** When installing an FPC beam connector, ensure that the end marked "MB" is connected to the system board and that the alignment pins on the connector are inserted into the openings on the boards.

Next steps

1. Install the [inner frame](#).
2. Install the [heat-sink assembly](#).
3. Install the [GPU power cable](#).
4. Install the [keyboard](#).
5. Install the [keyboard lattice](#).
6. Install the [SIM card](#).
7. Install the [primary memory](#).

8. Install the [WWAN card](#).
9. Install the [WLAN card](#).
10. Install the [secondary memory](#).
11. Install the [primary M.2 SSD](#).
12. Install the [battery](#).
13. Install the [base cover](#).
14. Install the [secondary M.2 SSD](#).
15. Install the [SD card](#).
16. Follow the procedure in [after working inside your computer](#).

Speaker

Removing the speaker

Prerequisites

1. Follow the procedure in [before working inside your computer](#).
2. Remove the [SD card](#).
3. Remove the [secondary M.2 SSD](#).
4. Remove the [base cover](#).
5. Remove the [battery](#).
6. Remove the [SIM card](#).
7. Remove the [secondary memory](#).
8. Remove the [WLAN card](#).
9. Remove the [WWAN card](#).
10. Remove the [primary M.2 SSD](#).
11. Remove the [keyboard lattice](#).
12. Remove the [keyboard](#).
13. Remove the [GPU power cable](#).
14. Remove the [GPU card](#).
15. Remove the [primary memory](#).
16. Remove the [heat-sink assembly](#).
17. Remove the [inner frame](#).
18. Remove the [system board](#).

About this task

The figure indicates the location of the speaker and provides a visual representation of the removal procedure.

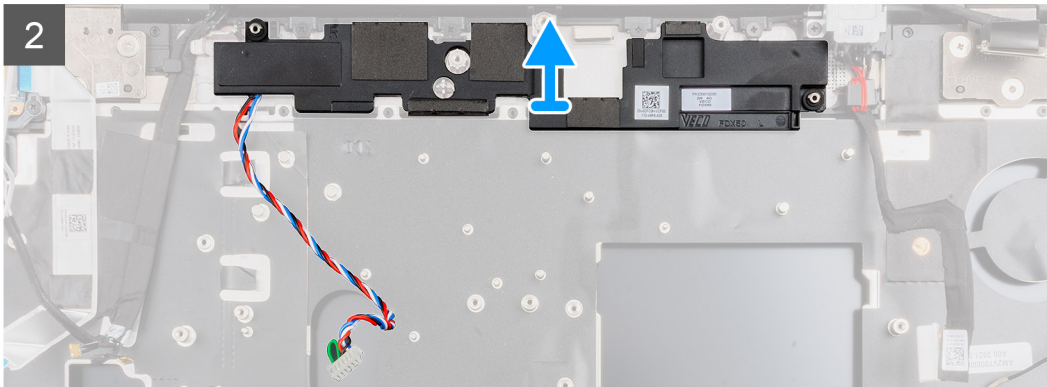
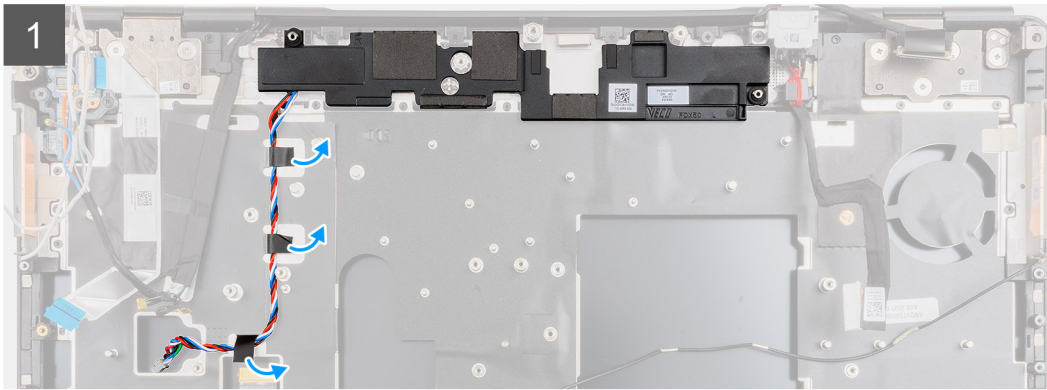
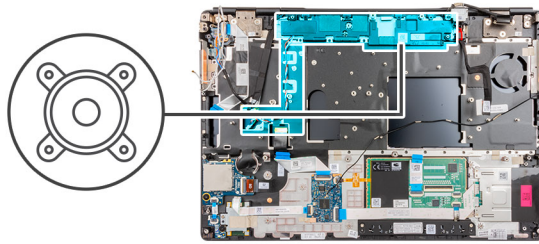

Steps

1. Peel the pieces of adhesive tape that secures the speaker cable to the palmrest.
2. Pry the speaker module from its slot on the top edge of the palmrest.
3. Remove the speaker module from the computer.

Installing the speaker

Prerequisites

If you are replacing a component, remove the existing component before performing the installation procedure.

About this task

The figure indicates the location of the speaker and provides a visual representation of the installation procedure.

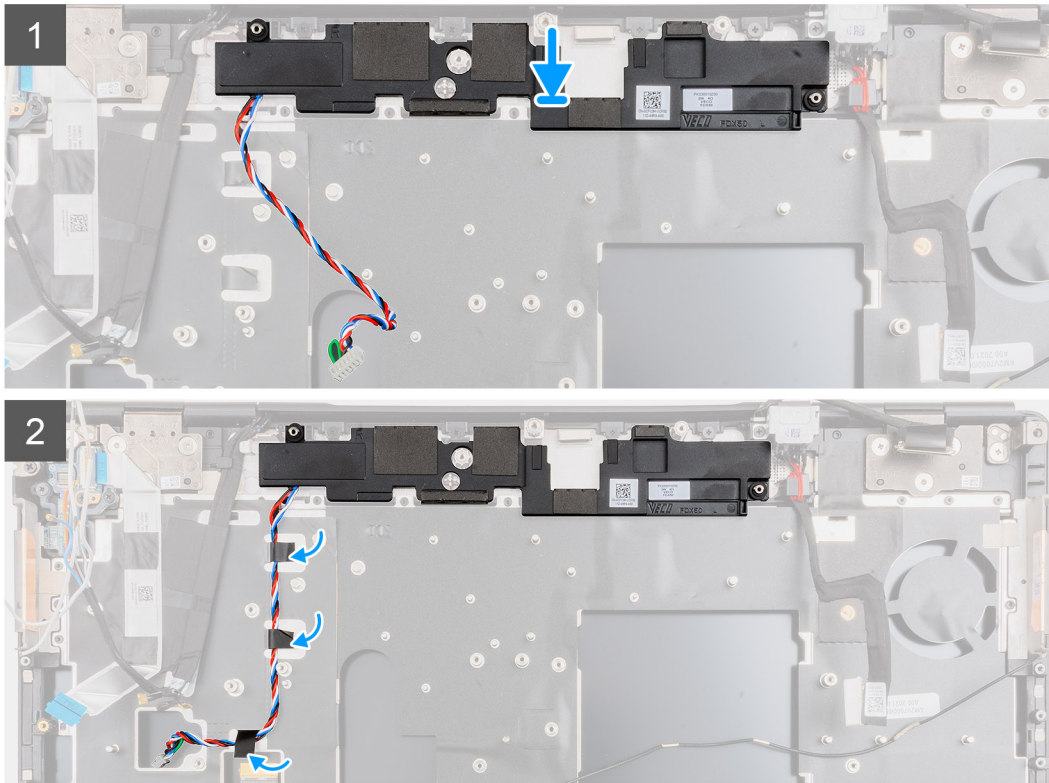
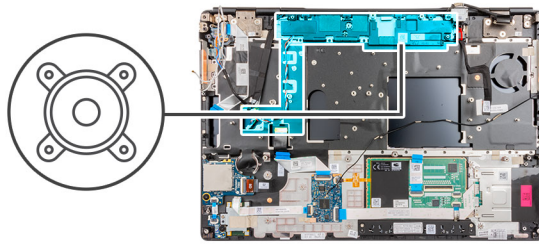

Steps

1. Align and place the speaker module into its slot on the top edge of the palmrest.
2. Adhere the three piece adhesive tape to secure the speaker cable in place on the palmrest.

Next steps

1. Install the [system board](#).
2. Install the [inner frame](#).
3. Install the [heat-sink assembly](#).
4. Install the [GPU card](#).
5. Install the [GPU power cable](#).
6. Install the [keyboard](#).
7. Install the [keyboard lattice](#).
8. Install the [SIM card](#).
9. Install the [primary memory](#).
10. Install the [WWAN card](#).
11. Install the [WLAN card](#).
12. Install the [secondary memory](#).
13. Install the [primary M.2 SSD](#).
14. Install the [battery](#).
15. Install the [base cover](#).
16. Install the [secondary M.2 SSD](#).
17. Install the [SD card](#).

18. Follow the procedure in [after working inside your computer](#).

Middle cap

Removing the middle cap

Prerequisites

1. Follow the procedure in [before working inside your computer](#).
2. Remove the [SD card](#).
3. Remove the [secondary M.2 SSD](#).
4. Remove the [base cover](#).
5. Remove the [battery](#).
6. Remove the [SIM card](#).
7. Remove the [secondary memory](#).
8. Remove the [WLAN card](#).
9. Remove the [WWAN card](#).
10. Remove the [primary M.2 SSD](#).
11. Remove the [keyboard lattice](#).
12. Remove the [keyboard](#).
13. Remove the [GPU power cable](#).
14. Remove the [GPU card](#).
15. Remove the [primary memory](#).
16. Remove the [heat-sink assembly](#).
17. Remove the [inner frame](#).
18. Remove the [system board](#).

About this task

The figure indicates the location of the speaker and provides a visual representation of the removal procedure.



4x
M2x3

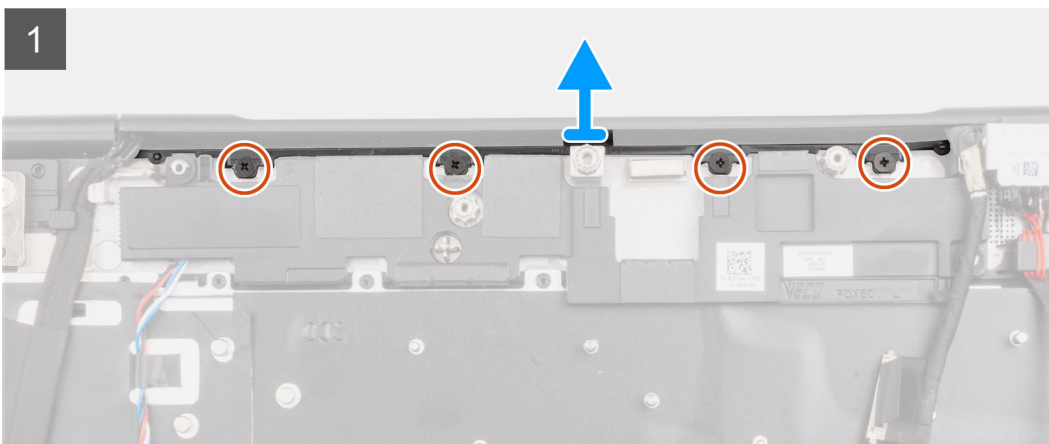
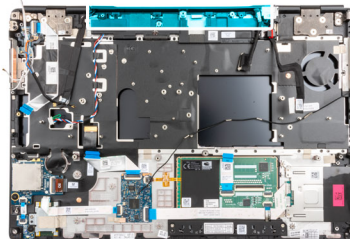

Steps

1. Remove the four (M2x3) screws that secures the middle cap in place.

2. Remove the middle cap from the computer.

Installing the middle cap

Prerequisites

If you are replacing a component, remove the existing component before performing the installation procedure.

About this task

The figure indicates the location of the middle cap and provides a visual representation of the installation procedure.



4x
M2x3

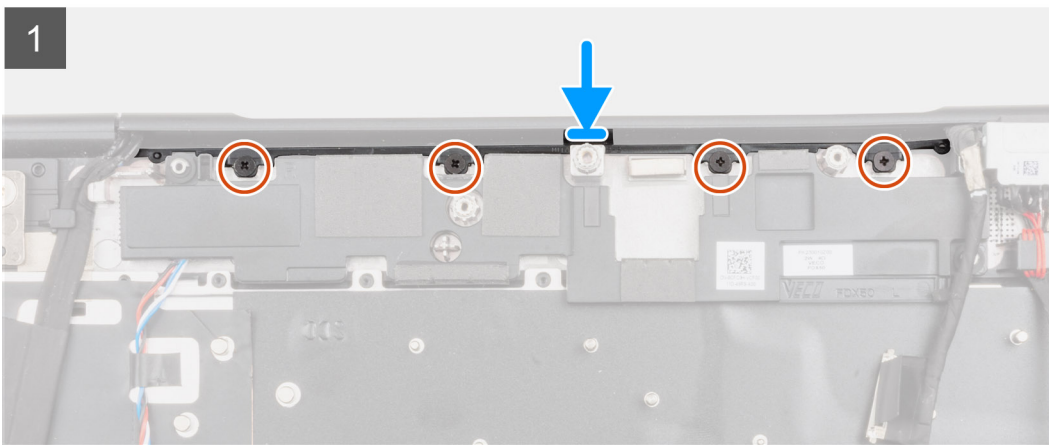
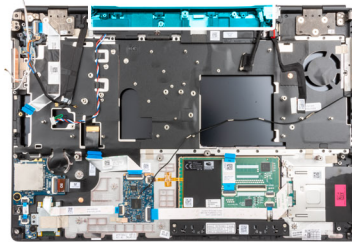

Steps

1. With the open side of the middle hinge cap facing down, push the cap into the right display hinge cap at an angle while tucking the WWAN antennas into its hollow center.

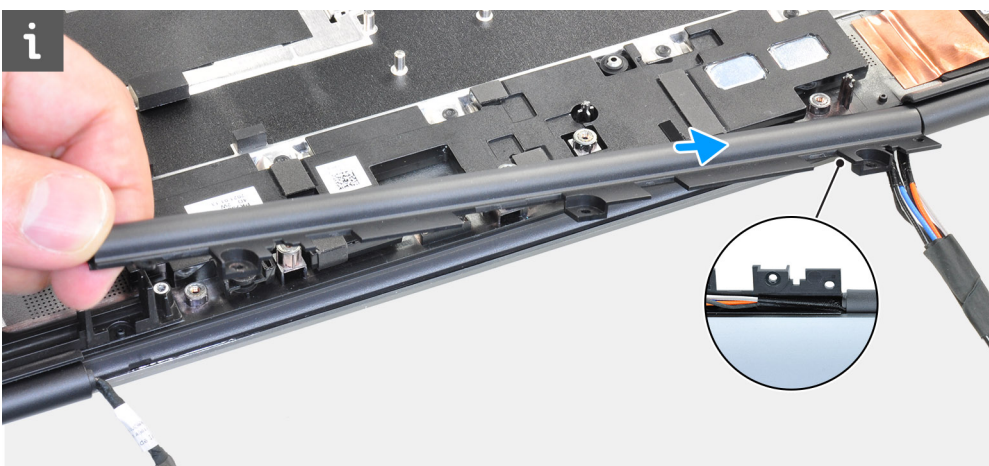

2. Push the other side of the cap into the left display hinge cap and tuck the display cable into the middle cap hollow center.

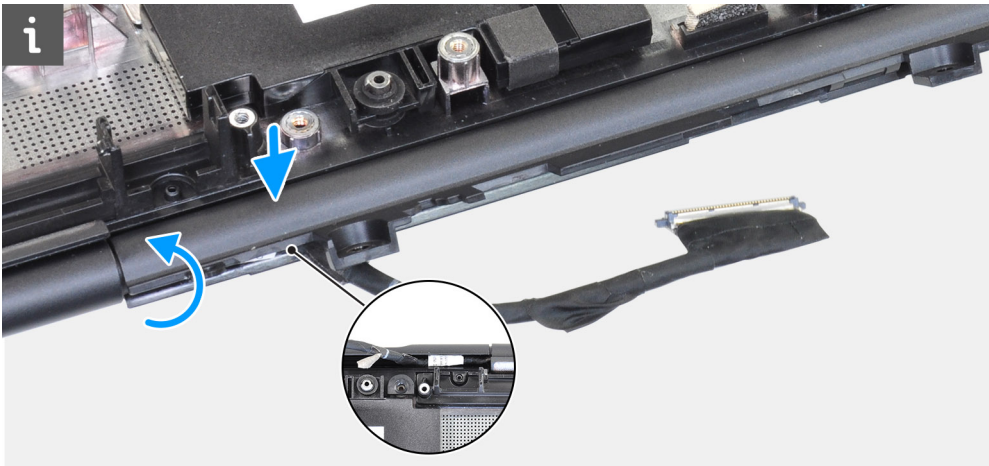

3. Rotate the hinge cap and tuck the tabs on the middle cap underneath the speaker module.

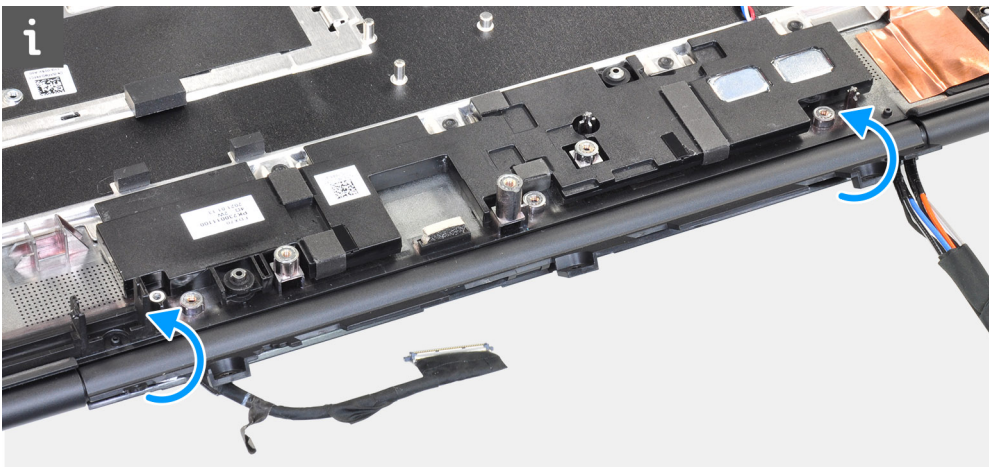

4. Align and insert the middle cap onto the palmrest.

i **NOTE:** Ensure that the openings on the left and right side of the middle cap is secured in place by the two alignment pegs on the palmrest.

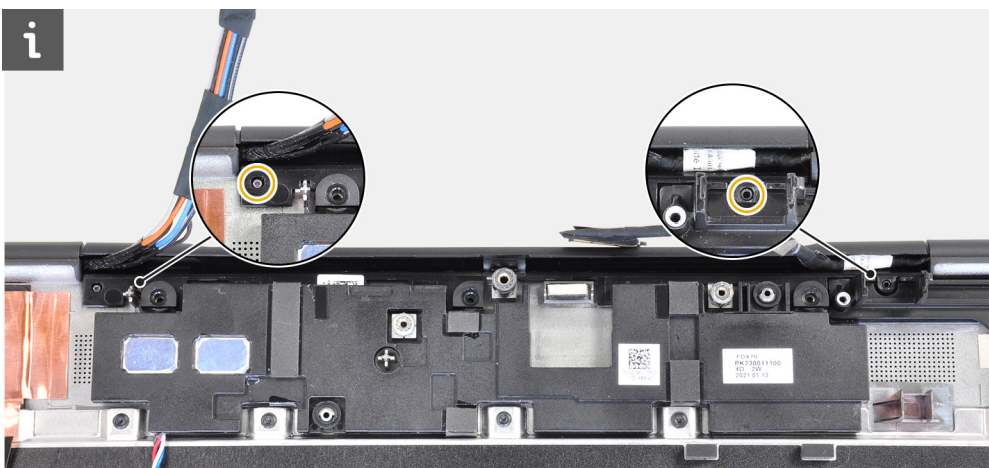

5. Replace the four (M2x3) screws to secure the middle cap in place.

Next steps

1. Install the [system board](#).
2. Install the [inner frame](#).
3. Install the [heat-sink assembly](#).
4. Install the [GPU card](#).

5. Install the [GPU power cable](#).
6. Install the [keyboard](#).
7. Install the [keyboard lattice](#).
8. Install the [SIM card](#).
9. Install the [primary memory](#).
10. Install the [WWAN card](#).
11. Install the [WLAN card](#).
12. Install the [secondary memory](#).
13. Install the [primary M.2 SSD](#).
14. Install the [battery](#).
15. Install the [base cover](#).
16. Install the [secondary M.2 SSD](#).
17. Install the [SD card](#).
18. Follow the procedure in [after working inside your computer](#).

Display assembly

Removing the display assembly

Prerequisites

1. Follow the procedure in [before working inside your computer](#).
2. Remove the [SD card](#).
3. Remove the [secondary M.2 SSD](#).
4. Remove the [base cover](#).
5. Remove the [battery](#).
6. Remove the [SIM card](#).
7. Remove the [secondary memory](#).
8. Remove the [WLAN card](#).
9. Remove the [WWAN card](#).
10. Remove the [primary M.2 SSD](#).
11. Remove the [keyboard lattice](#).
12. Remove the [keyboard](#).
13. Remove the [primary memory](#).
14. Remove the [heat-sink assembly](#).
15. Remove the [system board](#).
16. Remove the [power-adaptor port](#).

About this task

The figure indicates the location of the display assembly and provides a visual representation of the removal procedure.



8x
M2.5x2.5

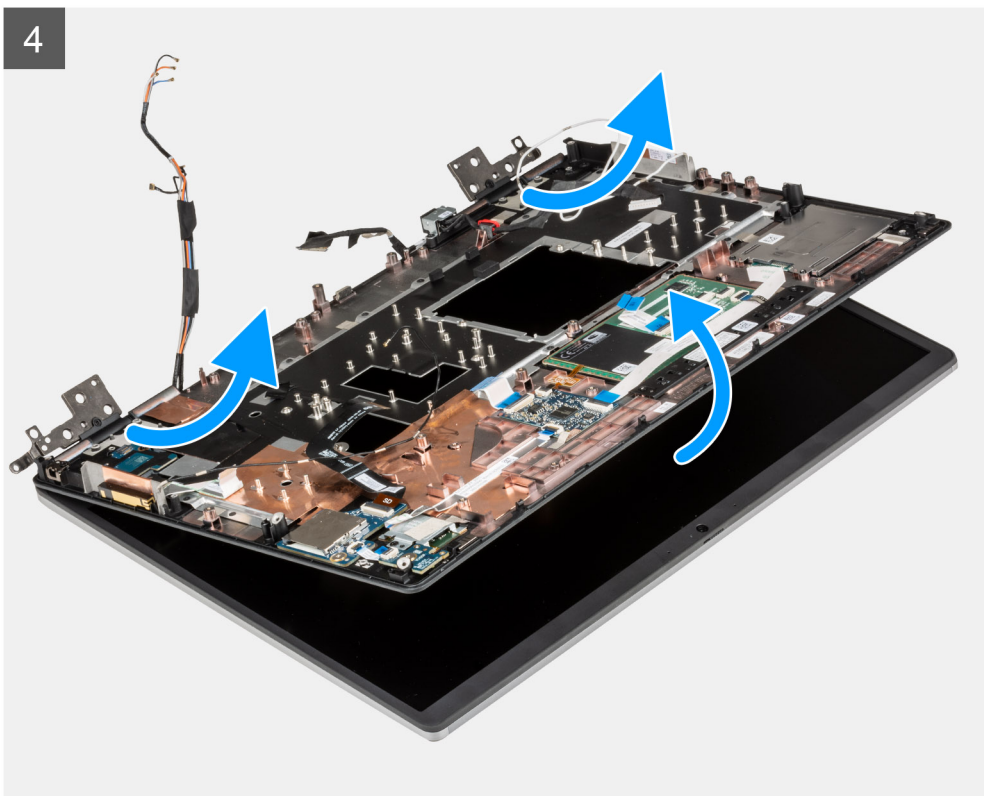
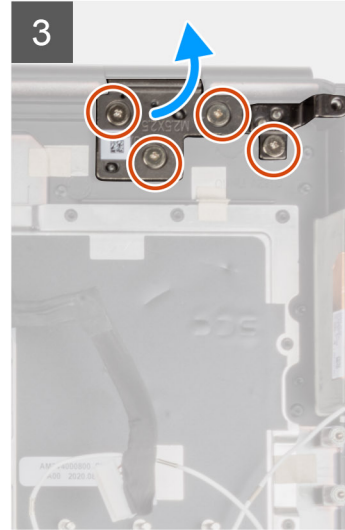
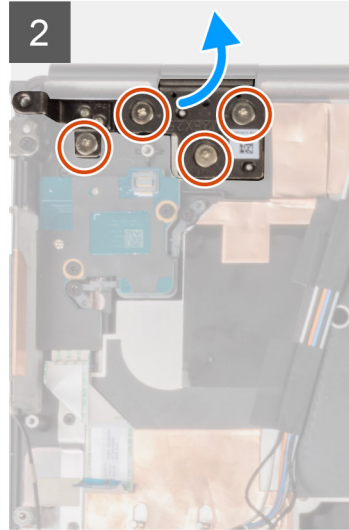
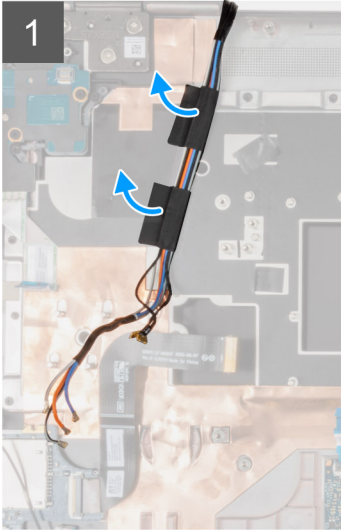
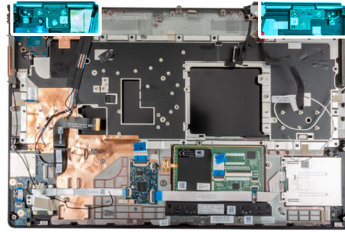



Steps

1. Open the display assembly to a 45-degree angle and place the computer at the edge of a flat table so that the display assembly can extend below the table.

NOTE: For computers shipped with IR camera configuration, disconnect the display cable and IR camera cable.

2. Peel and remove the WWAN cables and the Darwin cables from the palmrest.
3. Remove the eight (M2.5x2.5) screws that secure the hinges to the palmrest.
4. Remove the display assembly from the palmrest.

Installing the display assembly

Prerequisites

If you are replacing a component, remove the existing component before performing the installation procedure.

About this task

The figure indicates the location of the display assembly and provides a visual representation of the installation procedure.



8x
M2.5x2.5

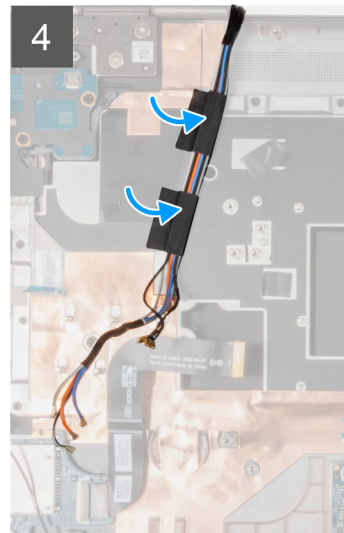
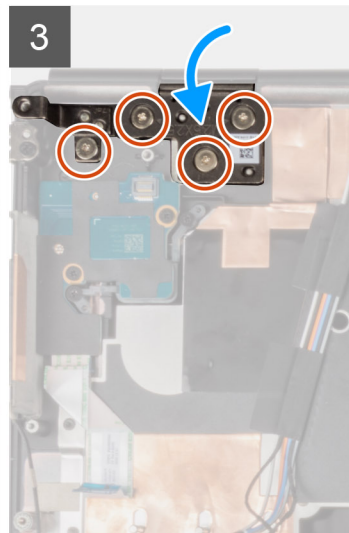
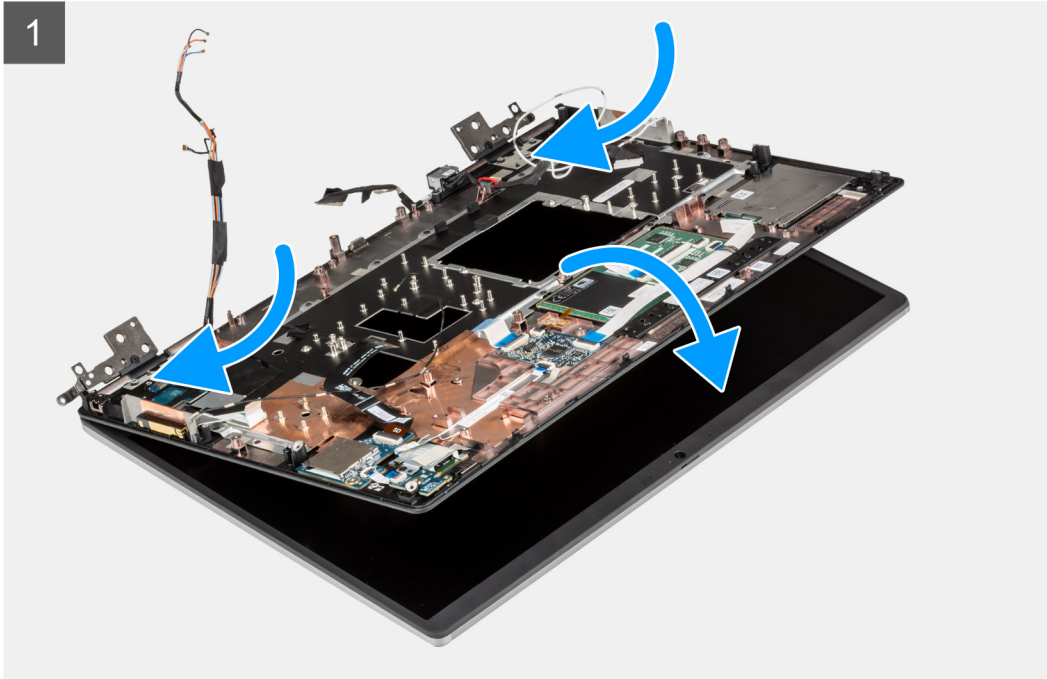
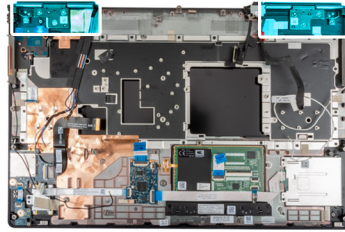

Steps

1.  **NOTE:** Before installing the display assembly, ensure that the display hinges are opened to a 140-degree angle against the display assembly, to fit the display assembly to the palmrest.
Align the screw holes on the hinges on the display assembly to the screw holes on the palmrest.
2. Replace the eight (M2.5x2.5) screws to secure the hinges to the palmrest.
3. Adhere the WWAN cables and Darwin cables to the palmrest.

NOTE: For computers shipped with IR camera configuration, connect the display cable and IR camera cable. Carefully route the cables between the hinges and the inside of the middle cap.

Next steps

1. Install the [power-adaptor port](#).
2. Install the [system board](#).
3. Install the [heat-sink assembly](#).
4. Install the [keyboard](#).
5. Install the [keyboard lattice](#).
6. Install the [SIM card](#).
7. Install the [primary memory](#).
8. Install the [WWAN card](#).
9. Install the [WLAN card](#).
10. Install the [secondary memory](#).
11. Install the [primary M.2 SSD](#).
12. Install the [battery](#).
13. Install the [base cover](#).
14. Install the [secondary M.2 SSD](#).
15. Install the [SD card](#).
16. Follow the procedure in [after working inside your computer](#).

Palm rest

Removing the palmrest

Prerequisites

1. Follow the procedure in [before working inside your computer](#).
2. Remove the [SD card](#).
3. Remove the [secondary M.2 SSD](#).
4. Remove the [base cover](#).
5. Remove the [battery](#).
6. Remove the [SIM card](#).
7. Remove the [secondary memory](#).
8. Remove the [WLAN card](#).
9. Remove the [WWAN card](#).
10. Remove the [primary M.2 SSD](#).
11. Remove the [keyboard lattice](#).
12. Remove the [keyboard](#).
13. Remove the [power button board](#) or [power button board assembly with fingerprint reader](#).
14. Remove the [smart-card reader](#).
15. Remove the [touchpad buttons](#).
16. Remove the [power button](#) or [power button assembly with fingerprint reader](#).
17. Remove the [SD card reader](#).
18. Remove the [GPU power cable](#).
19. Remove the [GPU card](#).
20. Remove the [primary memory](#).
21. Remove the [heat-sink assembly](#).
22. Remove the [inner frame](#).
23. Remove the [system board](#).
24. Remove the [power-adaptor port](#).
25. Remove the [speakers](#).
26. Remove the [middlecap](#).
27. Remove the [display assembly](#).

About this task

The picture below shows the palmrest after performing the pre-removal parts procedures for any palm rest replacement.

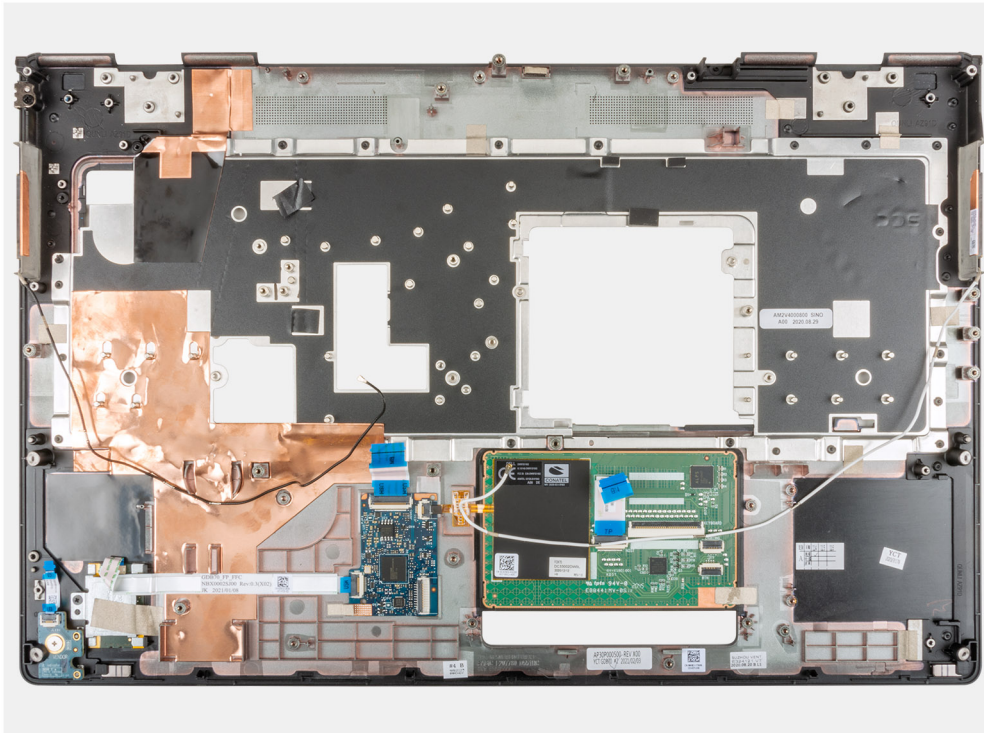

Installing the palmrest

Prerequisites

If you are replacing a component, remove the existing component before performing the installation procedure.

About this task

The figure indicates the palmrest and before performing the pre-installation parts procedures for any palmrest installation procedure.

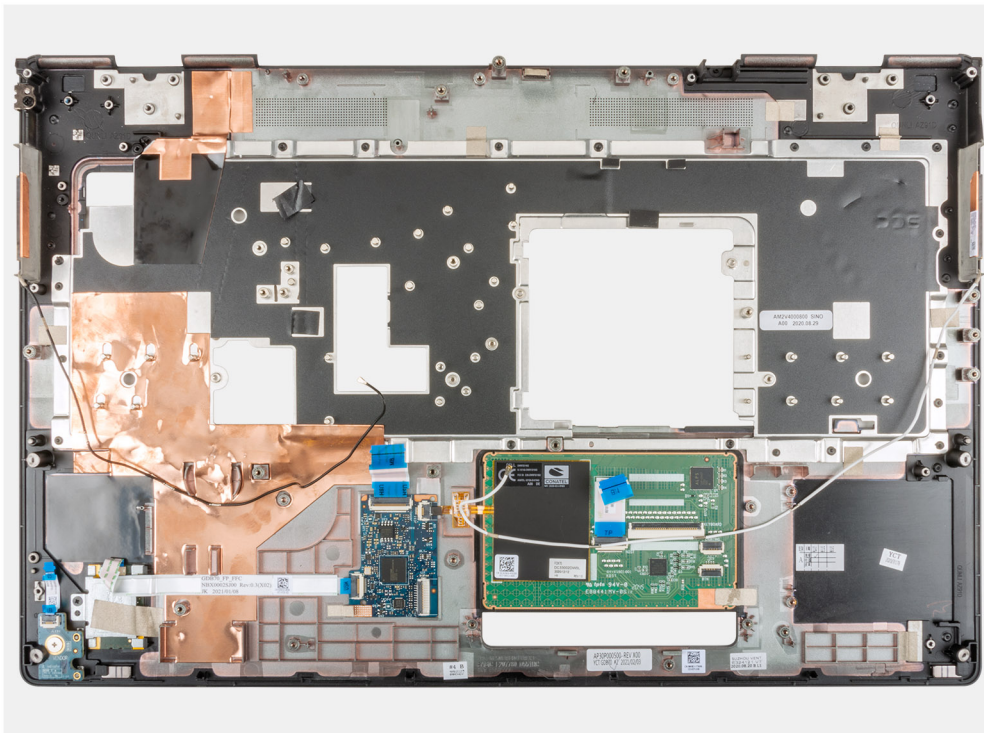

Next steps

1. Install the [display assembly](#).
2. Install the [middlecap](#).
3. Install the [speakers](#).
4. Install the [power-adapter port](#).
5. Install the [system board](#).
6. Install the [inner frame](#).
7. Install the [heat-sink assembly](#).
8. Install the [GPU card](#).
9. Install the [GPU power cable](#).
10. Install the [SD card reader](#).
11. Install the [power button](#) or [power button assembly with fingerprint reader](#).
12. Install the [touchpad button](#).
13. Install the [power button board](#) or [power button board assembly with fingerprint reader](#).
14. Install the [smart card reader](#).
15. Install the [keyboard](#).
16. Install the [keyboard lattice](#).
17. Install the [SIM card](#).
18. Install the [primary memory](#).
19. Install the [WWAN card](#).
20. Install the [WLAN card](#).
21. Install the [secondary memory](#).
22. Install the [primary M.2 SSD](#).
23. Install the [battery](#).
24. Install the [base cover](#).
25. Install the [secondary M.2 SSD](#).
26. Install the [SD card](#).
27. Follow the procedure in [after working inside your computer](#).

Display bezel

Removing the display bezel (non-touch)

Prerequisites

1. Follow the procedure in [before working inside your computer](#).
2. Remove the [SD card](#).
3. Remove the [secondary M.2 SSD](#).
4. Remove the [base cover](#).
5. Remove the [battery](#).
6. Remove the [SIM card](#).
7. Remove the [secondary memory](#).
8. Remove the [WLAN card](#).
9. Remove the [WWAN card](#).
10. Remove the [primary M.2 SSD](#).
11. Remove the [keyboard lattice](#).
12. Remove the [keyboard](#).
13. Remove the [GPU power cable](#).
14. Remove the [GPU card](#).
15. Remove the [primary memory](#).
16. Remove the [heat-sink assembly](#).
17. Remove the [inner frame](#).
18. Remove the [system board](#).
19. Remove the [speakers](#).
20. Remove the [middlecap](#).
21. Remove the [display assembly](#).

About this task

The figure indicates the location of the display bezel and provides a visual representation of the removal procedure.

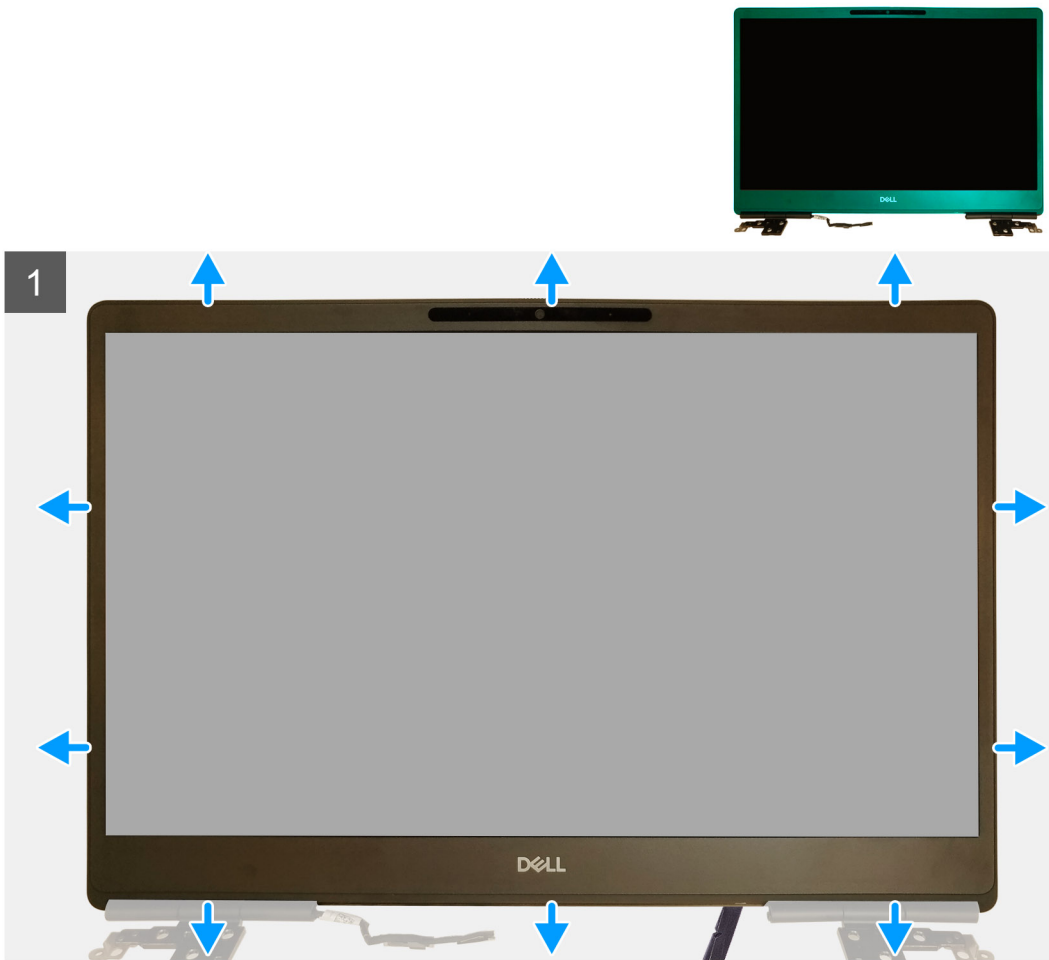

Steps

1. Using a flat head tool or a plastic scribe, pry open the display bezel from the two recess points on the bottom edge of the display bezel.
2. Working your way from the bottom edge, pry around the sides and top edge of the display bezel.
NOTE: While prying the display bezel, ensure to pry along the outside edge of the display bezel using your hands—using a screw driver or other sharp objects may damage the display cover.
3. Remove the display bezel from the display assembly.

Installing the display bezel (non-touch)

Prerequisites

If you are replacing a component, remove the existing component before performing the installation procedure.

About this task

The figure indicates the display bezel and provides a visual representation of the installation procedure.

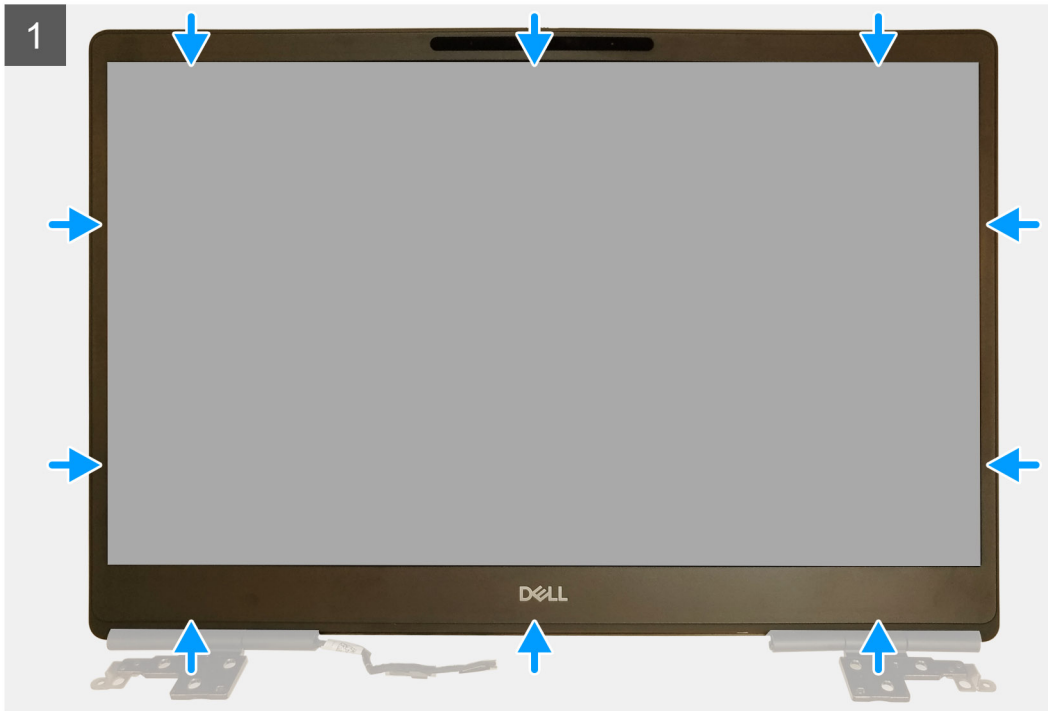

Steps

1. Place the display bezel on the display assembly.
2. Press the edges of the display bezel until it clicks onto the display assembly.

Next steps

1. Install the [display assembly](#).
2. Install the [middlecap](#).
3. Install the [speakers](#).
4. Install the [system board](#).
5. Install the [inner frame](#).
6. Install the [heat-sink assembly](#).
7. Install the [GPU card](#).
8. Install the [GPU power cable](#).
9. Install the [keyboard](#).
10. Install the [keyboard lattice](#).
11. Install the [SIM card](#).
12. Install the [primary memory](#).
13. Install the [WWAN card](#).
14. Install the [WLAN card](#).
15. Install the [secondary memory](#).
16. Install the [primary M.2 SSD](#).
17. Install the [battery](#).
18. Install the [base cover](#).
19. Install the [secondary M.2 SSD](#).

20. Install the [SD card](#).
21. Follow the procedure in [after working inside your computer](#).

Display panel

Removing the display panel (non-touch)

Prerequisites

1. Follow the procedure in [before working inside your computer](#).
2. Remove the [SD card](#).
3. Remove the [secondary M.2 SSD](#).
4. Remove the [base cover](#).
5. Remove the [battery](#).
6. Remove the [SIM card](#).
7. Remove the [secondary memory](#).
8. Remove the [WLAN card](#).
9. Remove the [WWAN card](#).
10. Remove the [primary M.2 SSD](#).
11. Remove the [keyboard lattice](#).
12. Remove the [keyboard](#).
13. Remove the [SD card reader](#).
14. Remove the [GPU power cable](#).
15. Remove the [GPU card](#).
16. Remove the [primary memory](#).
17. Remove the [heat-sink assembly](#).
18. Remove the [inner frame](#).
19. Remove the [system board](#).
20. Remove the [speakers](#).
21. Remove the [middlecap](#).
22. Remove the [display assembly](#).
23. Remove the [display bezel](#).

About this task

The figure indicates the location of the display panel and provides a visual representation of the removal procedure.

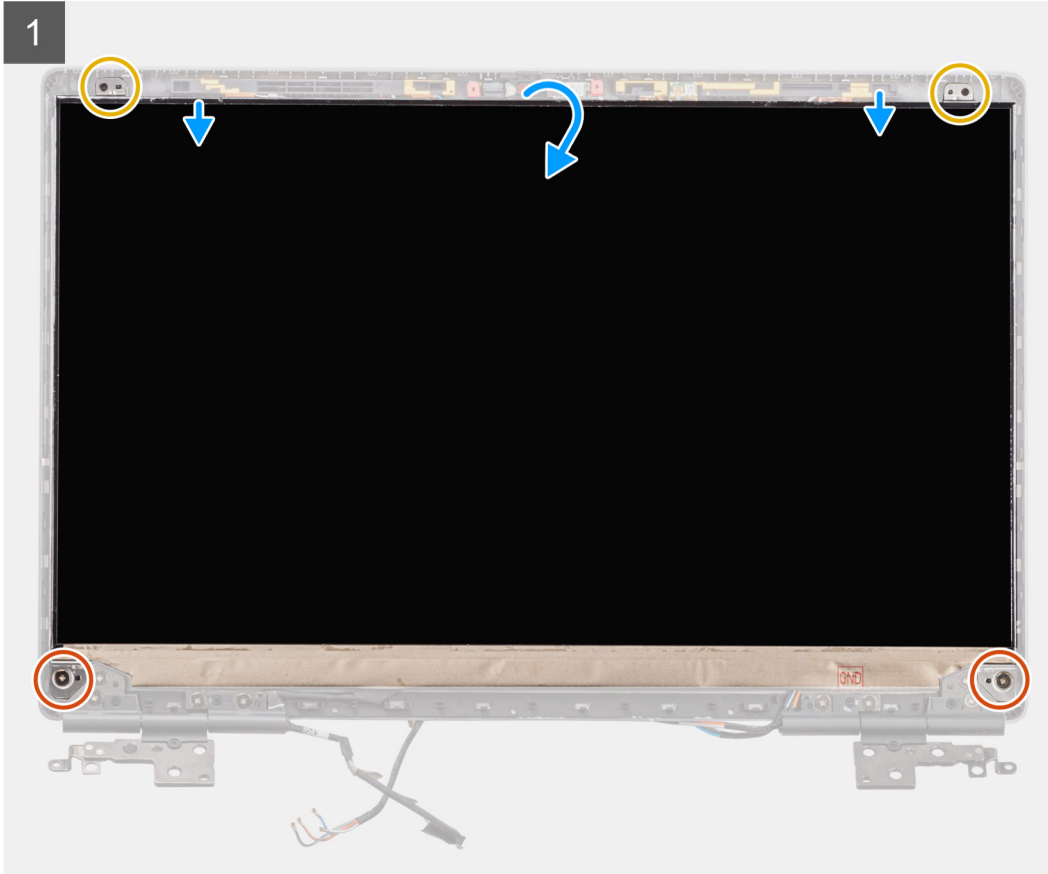
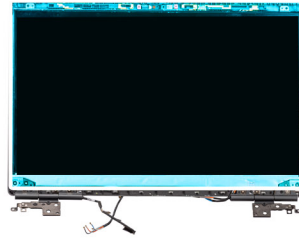
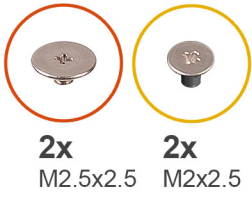

2

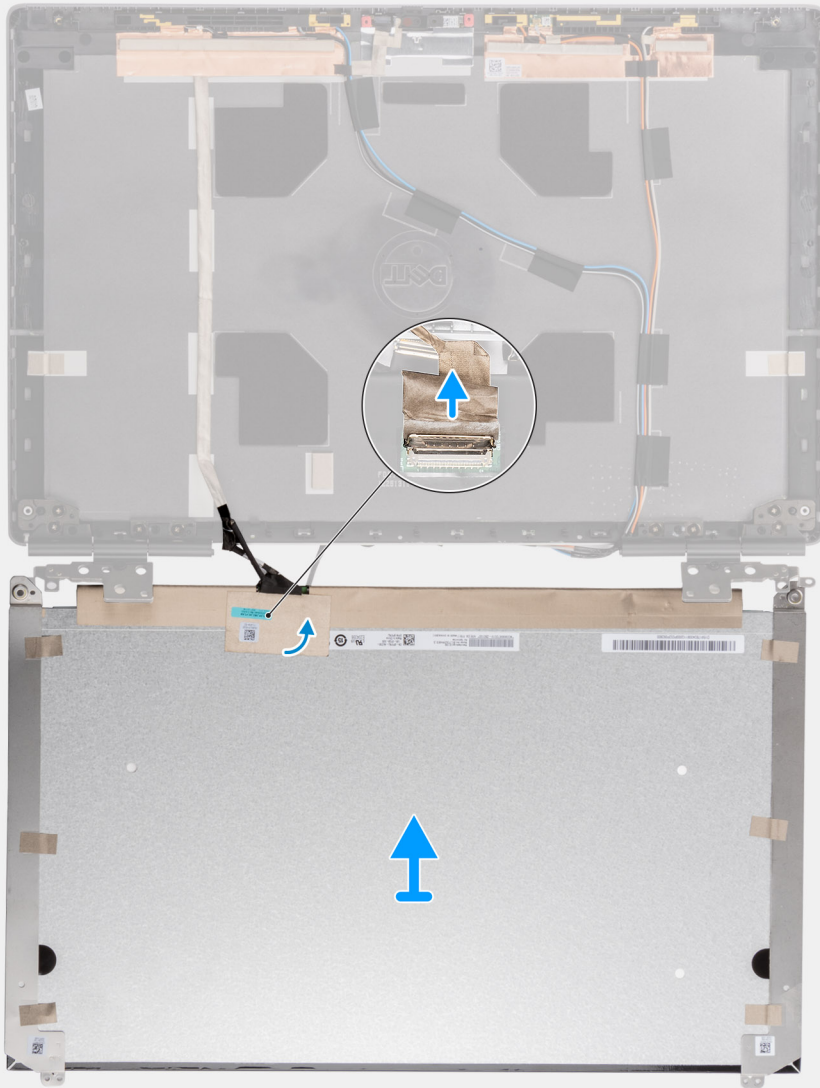



Steps

1. Remove the two (M2.5x2.5) screws and the two (M2x2.5) screws that secure the display panel to the display assembly.
2. Lift the display panel and turn the display panel over to access the display cable.
3. Peel the conductive tape covering the display cable.
4. Peel the adhesive tapes that secure the display cable connector.
5. Peel the adhesive rubber strip covering the display cable connector.
6. Unlock the display cable connector and then disconnect the display cable from the back of the display panel.
7. Remove the display panel from the display assembly.
8. Remove the display panel.

 **NOTE:** The support brackets attached to the display panel are defined as a single service assembly part and cannot be further disassembled.

Installing the display panel (non-touch)

Prerequisites

If you are replacing a component, remove the existing component before performing the installation procedure.

About this task

The figure indicates the display panel and provides a visual representation of the installation procedure.

1

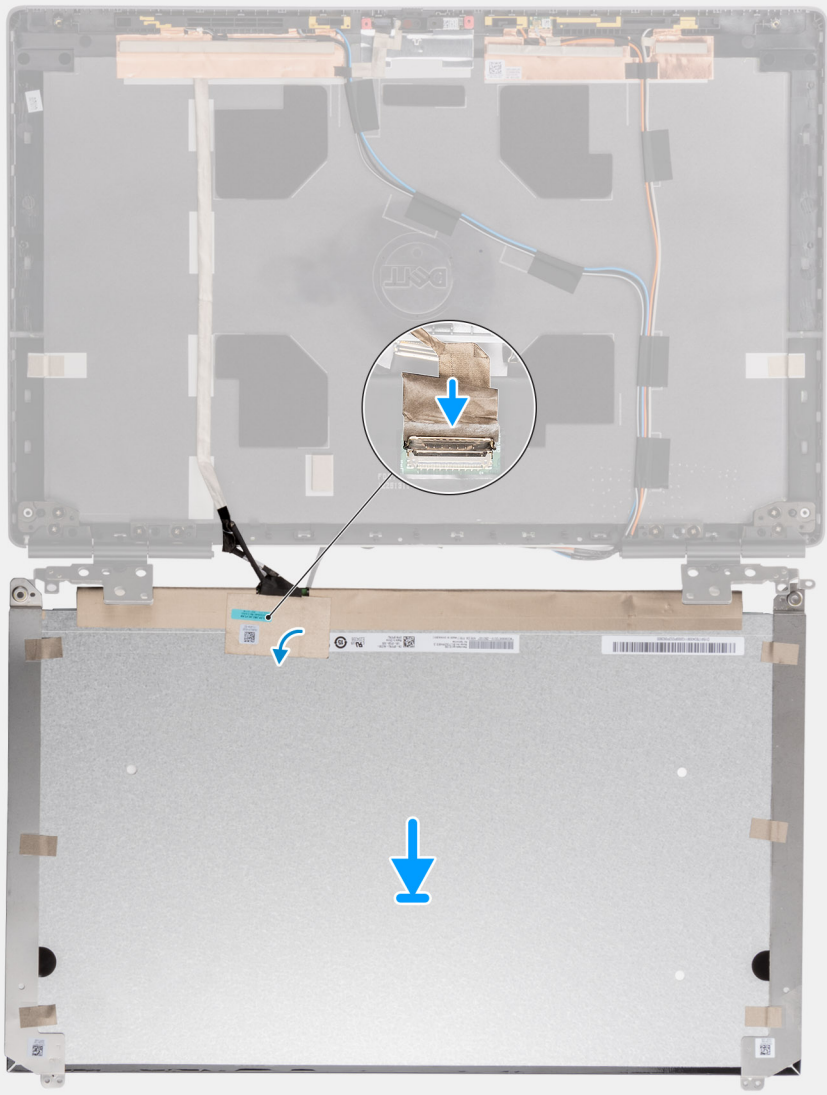

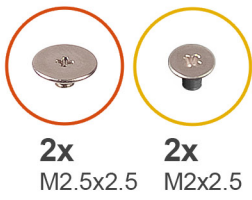

2x

M2.5x2.5

2x

M2x2.5

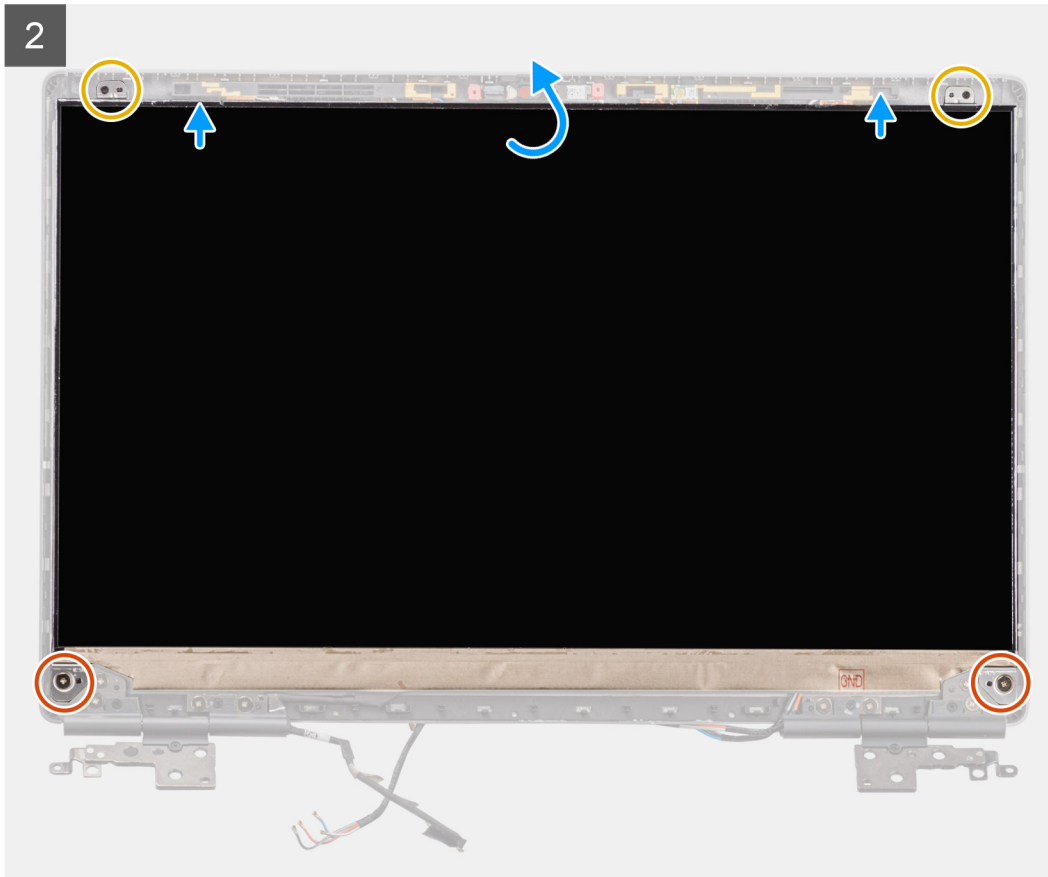
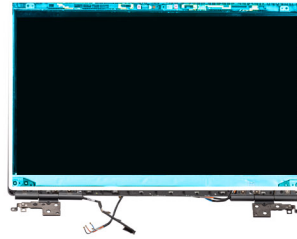

Steps

1. Connect the display cable to the connector on the back of the display panel and lock the display cable connector.
2. Adhere the adhesive rubber strip to cover the display cable connector.
3. Adhere the transparent tape and conductive tape above the rubber strip to cover the display cable connector.
4. Align the display panel with the tabs on the display assembly.
5. Replace the two (M2.5X2.5) and two (M2x2.5) screws to secure the display panel to the display assembly.

Next steps

1. Install the [display bezel](#).
2. Install the [display assembly](#).
3. Install the [middlecap](#).
4. Install the [speakers](#).
5. Install the [system board](#).
6. Install the [inner frame](#).
7. Install the [heat-sink assembly](#).
8. Install the [GPU card](#).
9. Install the [GPU power cable](#).
10. Install the [SD card reader](#).
11. Install the [keyboard](#).

12. Install the [keyboard lattice](#).
13. Install the [SIM card](#).
14. Install the [primary memory](#).
15. Install the [WWAN card](#).
16. Install the [WLAN card](#).
17. Install the [secondary memory](#).
18. Install the [primary M.2 SSD](#).
19. Install the [battery](#).
20. Install the [base cover](#).
21. Install the [secondary M.2 SSD](#).
22. Install the [SD card](#).
23. Follow the procedure in [after working inside your computer](#).

Display hinges

Removing the display hinge

Prerequisites

1. Follow the procedure in [before working inside your computer](#).
2. Remove the [SD card](#).
3. Remove the [secondary M.2 SSD](#).
4. Remove the [base cover](#).
5. Remove the [battery](#).
6. Remove the [SIM card](#).
7. Remove the [secondary memory](#).
8. Remove the [WLAN card](#).
9. Remove the [WWAN card](#).
10. Remove the [primary M.2 SSD](#).
11. Remove the [keyboard lattice](#).
12. Remove the [keyboard](#).
13. Remove the [SD card reader](#).
14. Remove the [GPU power cable](#).
15. Remove the [GPU card](#).
16. Remove the [primary memory](#).
17. Remove the [heat-sink assembly](#).
18. Remove the [inner frame](#).
19. Remove the [system board](#).
20. Remove the [speakers](#).
21. Remove the [middlecap](#).
22. Remove the [display assembly](#).
23. Remove the [display bezel](#).
24. Remove the [display panel](#).

About this task

The figure indicates the location of the display hinge and provides a visual representation of the removal procedure.



8x
M2.5x2.5

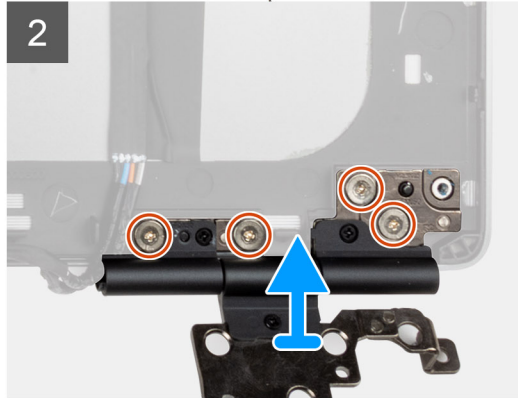
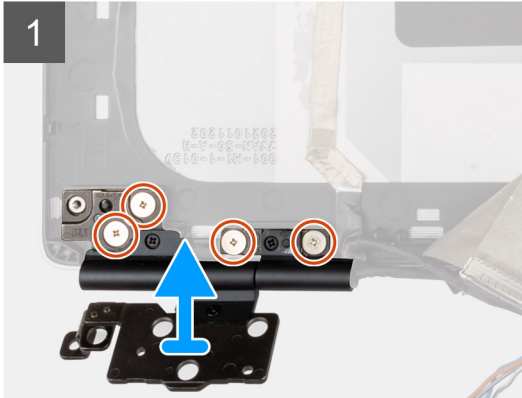
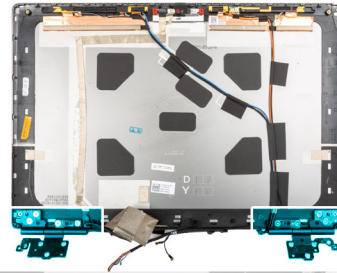

Steps

1. Remove the eight (M2.5x2.5) screws that secure the display hinges to the display assembly.
2. Remove the display hinges.

Installing the display hinge (non-touch)

Prerequisites

If you are replacing a component, remove the existing component before performing the installation procedure.

About this task

The figure indicates the display hinge and provides a visual representation of the installation procedure.



8x
M2.5x2.5

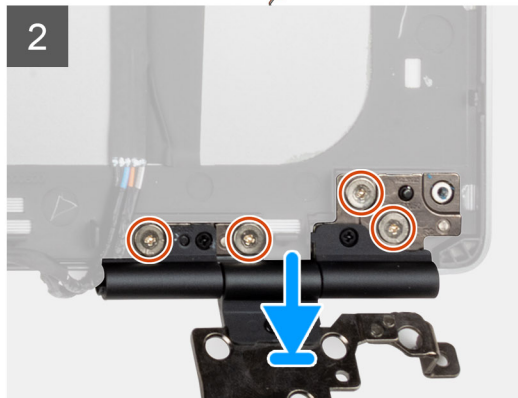
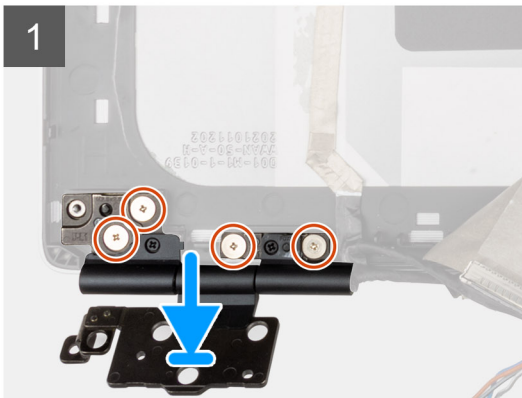
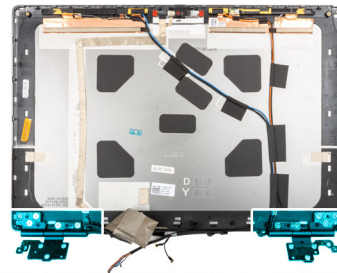

Steps

1. Place the display hinge in its slot on the display assembly.
2. Replace the eight (M2.5x2.5) screws to secure the display hinge to the display assembly.

Next steps

1. Install the [display panel](#).
2. Install the [display bezel](#).
3. Install the [display assembly](#).
4. Install the [middlecap](#).
5. Install the [speakers](#).
6. Install the [system board](#).
7. Install the [inner frame](#).
8. Install the [heat-sink assembly](#).
9. Install the [GPU card](#).
10. Install the [GPU power cable](#).
11. Install the [SD card reader](#).
12. Install the [keyboard](#).
13. Install the [keyboard lattice](#).
14. Install the [SIM card](#).
15. Install the [primary memory](#).
16. Install the [WWAN card](#).
17. Install the [WLAN card](#).
18. Install the [secondary memory](#).
19. Install the [primary M.2 SSD](#).
20. Install the [battery](#).
21. Install the [base cover](#).
22. Install the [secondary M.2 SSD](#).
23. Install the [SD card](#).
24. Follow the procedure in [after working inside your computer](#).

Camera shutter cap

Removing camera shutter cap

Prerequisites

1. Follow the procedure in [before working inside your computer](#).
2. Remove the [SD card](#).
3. Remove the [secondary M.2 SSD](#).
4. Remove the [base cover](#).
5. Remove the [battery](#).
6. Remove the [SIM card](#).
7. Remove the [secondary memory](#).
8. Remove the [WLAN card](#).
9. Remove the [WWAN card](#).
10. Remove the [primary M.2 SSD](#).
11. Remove the [keyboard lattice](#).
12. Remove the [keyboard](#).
13. Remove the [SD card reader](#).
14. Remove the [GPU power cable](#).
15. Remove the [GPU card](#).
16. Remove the [primary memory](#).
17. Remove the [heat-sink assembly](#).
18. Remove the [inner frame](#).

19. Remove the [system board](#).
20. Remove the [speakers](#).
21. Remove the [display assembly](#).
22. Remove the [display bezel](#).
23. Remove the [display panel](#).

About this task

The figure indicates the location of the camera shutter cap and provides a visual representation of the removal procedure.

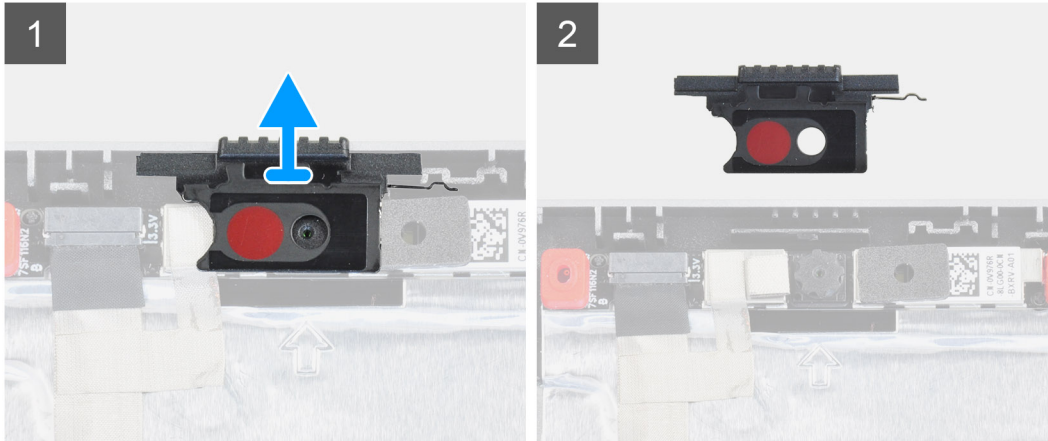

Steps

1. Pull the camera shutter cap from its slot on the display back cover.
2. Remove the camera shutter cap from the camera module.

Installing camera shutter cap

Prerequisites

If you are replacing a component, remove the existing component before performing the installation procedure.

About this task

The figure indicates the location of the camera shutter cap and provides a visual representation of the installation procedure.

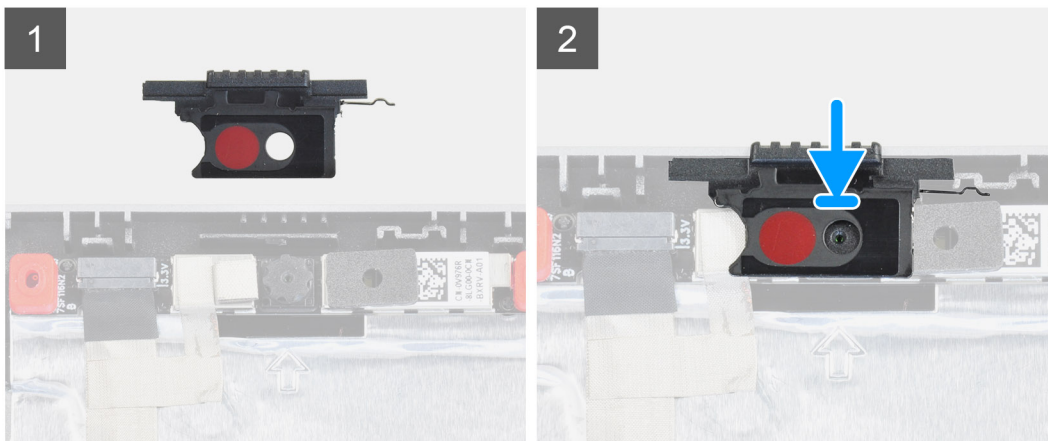

Steps

1. Align the cap with the display back cover so that the red dot on the cap faces up and the opening on the cap aligns with the aperture on the camera.
2. Place the cap onto the camera module.

3. Press the cap until it clicks into place to secure the cap into its slot.

Next steps

1. Install the [display panel](#).
2. Install the [display bezel](#).
3. Install the [display assembly](#).
4. Install the [speakers](#).
5. Install the [system board](#).
6. Install the [inner frame](#).
7. Install the [heat-sink assembly](#).
8. Install the [GPU card](#).
9. Install the [GPU power cable](#).
10. Install the [SD card reader](#).
11. Install the [keyboard](#).
12. Install the [keyboard lattice](#).
13. Install the [SIM card](#).
14. Install the [primary memory](#).
15. Install the [WWAN card](#).
16. Install the [WLAN card](#).
17. Install the [secondary memory](#).
18. Install the [primary M.2 SSD](#).
19. Install the [battery](#).
20. Install the [base cover](#).
21. Install the [secondary M.2 SSD](#).
22. Install the [SD card](#).
23. Follow the procedure in [after working inside your computer](#).

Camera

Removing the camera (non-touch)

Prerequisites

1. Follow the procedure in [before working inside your computer](#).
2. Remove the [SD card](#).
3. Remove the [secondary M.2 SSD](#).
4. Remove the [base cover](#).
5. Remove the [battery](#).
6. Remove the [SIM card](#).
7. Remove the [secondary memory](#).
8. Remove the [WLAN card](#).
9. Remove the [WWAN card](#).
10. Remove the [primary M.2 SSD](#).
11. Remove the [keyboard lattice](#).
12. Remove the [keyboard](#).
13. Remove the [SD card reader](#).
14. Remove the [GPU power cable](#).
15. Remove the [GPU card](#).
16. Remove the [primary memory](#).
17. Remove the [heat-sink assembly](#).
18. Remove the [inner frame](#).
19. Remove the [system board](#).
20. Remove the [speakers](#).
21. Remove the [display assembly](#).
22. Remove the [display bezel](#).

23. Remove the [display panel](#).
24. Remove the [camera shutter cap](#).

About this task

The figure indicates the location of the camera and provides a visual representation of the removal procedure.

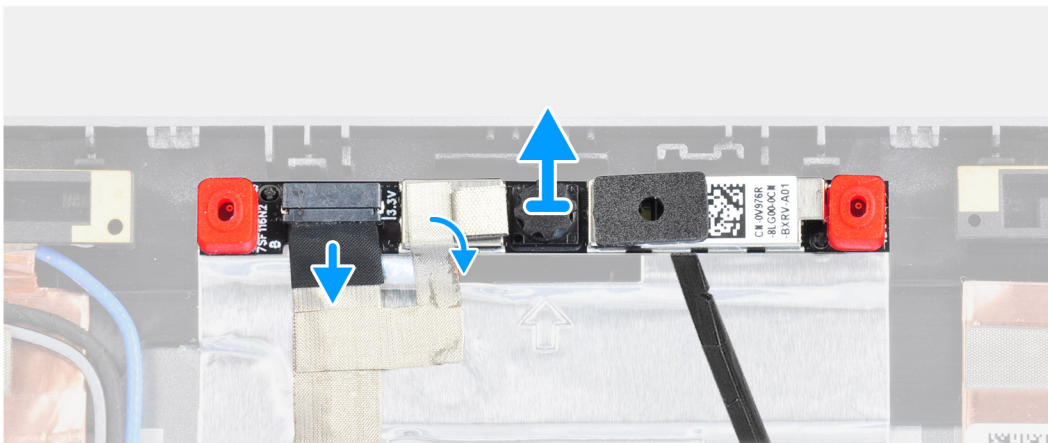
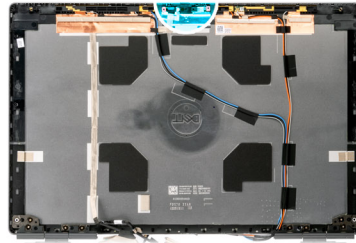

Steps

1. Peel the adhesive tape that covers the camera module.
2. Disconnect the display cable from the camera module.
3. Gently pry the camera shutter cap from the top edge of the camera shutter and remove it from the display back cover.
4. Gently pry the camera module from the display back cover.

Installing the camera

Prerequisites

If you are replacing a component, remove the existing component before performing the installation procedure.

About this task

The figure indicates the camera and provides a visual representation of the installation procedure.

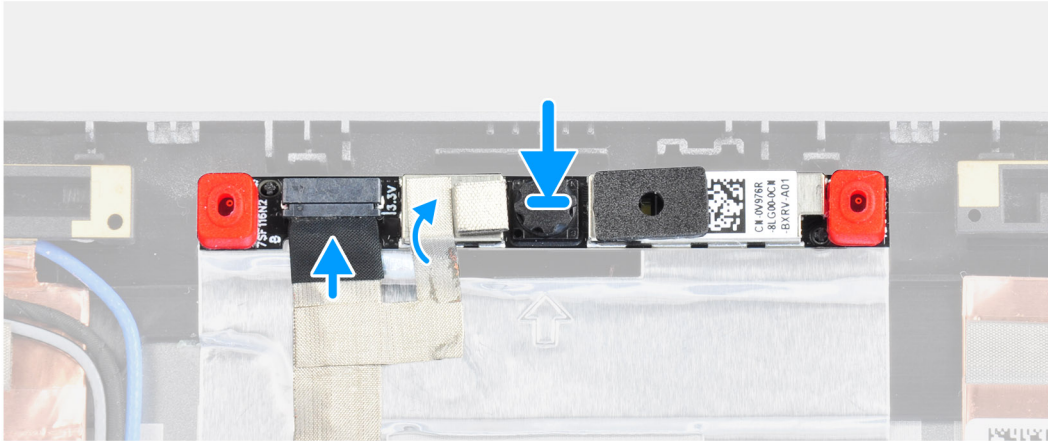
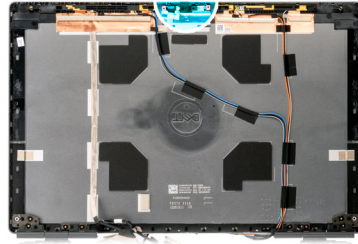

Steps

1. Place the camera module in its slot on the display back cover.
2. Place the camera shutter cap on the top edge of the camera shutter.
3. Connect the display cable to the camera module.
4. Adhere the adhesive tape to cover the camera module.

Next steps

1. Install the [camera shutter cap](#).
2. Install the [display panel](#).
3. Install the [display bezel](#).
4. Install the [display assembly](#).
5. Install the [speakers](#).
6. Install the [system board](#).
7. Install the [inner frame](#).
8. Install the [heat-sink assembly](#).
9. Install the [GPU card](#).
10. Install the [GPU power cable](#).
11. Install the [SD card reader](#).
12. Install the [keyboard](#).
13. Install the [keyboard lattice](#).
14. Install the [SIM card](#).
15. Install the [primary memory](#).
16. Install the [WWAN card](#).
17. Install the [WLAN card](#).
18. Install the [secondary memory](#).
19. Install the [primary M.2 SSD](#).
20. Install the [battery](#).
21. Install the [base cover](#).
22. Install the [secondary M.2 SSD](#).
23. Install the [SD card](#).
24. Follow the procedure in [after working inside your computer](#).

P-sensor board

Removing the P-sensor board

Prerequisites

1. Follow the procedure in [before working inside your computer](#).
2. Remove the [SD card](#).
3. Remove the [secondary M.2 SSD](#).
4. Remove the [base cover](#).
5. Remove the [battery](#).
6. Remove the [SIM card](#).
7. Remove the [secondary memory](#).
8. Remove the [WLAN card](#).
9. Remove the [WWAN card](#).
10. Remove the [primary M.2 SSD](#).
11. Remove the [keyboard lattice](#).
12. Remove the [keyboard](#).
13. Remove the [SD card reader](#).
14. Remove the [GPU power cable](#).
15. Remove the [GPU card](#).
16. Remove the [primary memory](#).
17. Remove the [heat-sink assembly](#).
18. Remove the [inner frame](#).
19. Remove the [system board](#).
20. Remove the [speakers](#).
21. Remove the [middlecap](#).
22. Remove the [display assembly](#).
23. Remove the [display bezel](#).
24. Remove the [display panel](#).

About this task

The figure indicates the location of the P-sensor board and provides a visual representation of the removal procedure.

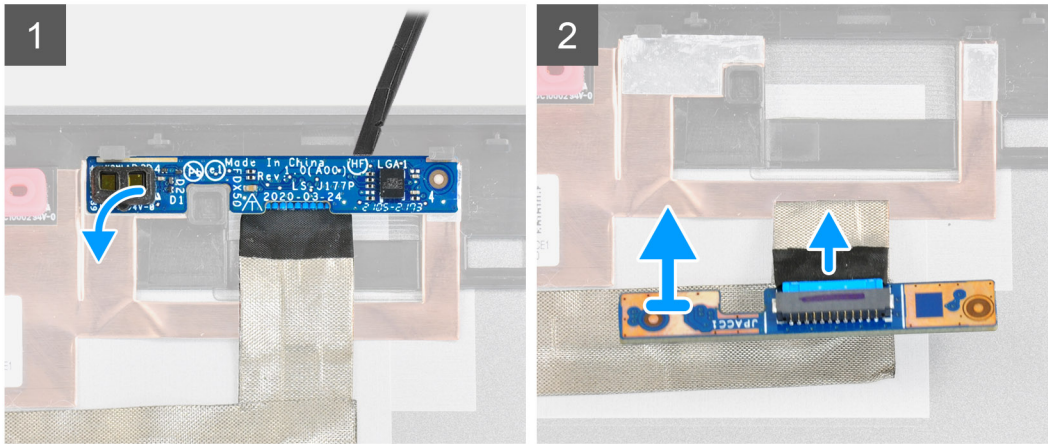

Steps

1. Gently pry the P-sensor board from its slot on the display back cover.
2. Flip over the P-sensor board.
3. Disconnect the display cable from the P-sensor board.
4. Remove the P-sensor board.

Installing the P-sensor board

Prerequisites

If you are replacing a component, remove the existing component before performing the installation procedure.

About this task

The figure indicates the P-sensor board and provides a visual representation of the installation procedure.

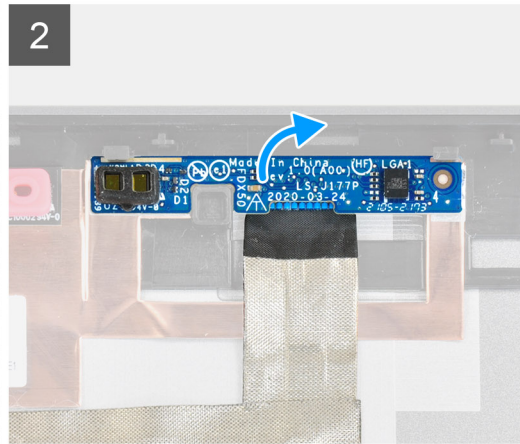
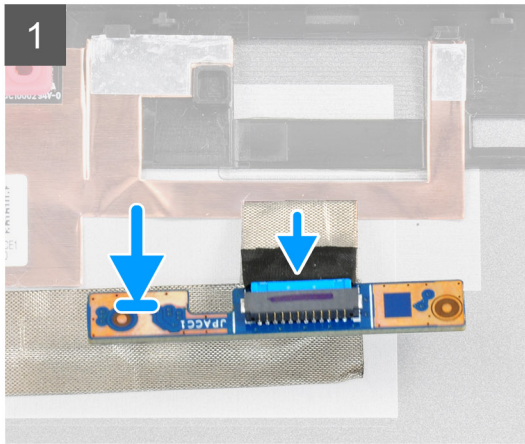

Steps

1. Connect the display cable to the P-sensor board.
2. Flip the P-sensor board and place it gently in its slot on the display back cover.

Next steps

1. Install the [display panel](#).
2. Install the [display bezel](#).
3. Install the [display assembly](#).
4. Install the [middlecap](#).
5. Install the [speakers](#).
6. Install the [system board](#).
7. Install the [inner frame](#).
8. Install the [heat-sink assembly](#).
9. Install the [GPU card](#).
10. Install the [GPU power cable](#).
11. Install the [SD card reader](#).
12. Install the [keyboard](#).
13. Install the [keyboard lattice](#).
14. Install the [SIM card](#).
15. Install the [primary memory](#).
16. Install the [WWAN card](#).
17. Install the [WLAN card](#).
18. Install the [secondary memory](#).
19. Install the [primary M.2 SSD](#).
20. Install the [battery](#).
21. Install the [base cover](#).
22. Install the [secondary M.2 SSD](#).
23. Install the [SD card](#).
24. Follow the procedure in [after working inside your computer](#).

Display cable

Removing the display cable

Prerequisites

1. Follow the procedure in [before working inside your computer](#).
2. Remove the [SD card](#).
3. Remove the [secondary M.2 SSD](#).
4. Remove the [base cover](#).
5. Remove the [battery](#).
6. Remove the [SIM card](#).
7. Remove the [secondary memory](#).
8. Remove the [WLAN card](#).
9. Remove the [WWAN card](#).
10. Remove the [primary M.2 SSD](#).
11. Remove the [keyboard lattice](#).
12. Remove the [keyboard](#).
13. Remove the [SD card reader](#).
14. Remove the [GPU power cable](#).
15. Remove the [GPU card](#).
16. Remove the [primary memory](#).
17. Remove the [heat-sink assembly](#).
18. Remove the [inner frame](#).
19. Remove the [system board](#).
20. Remove the [speakers](#).
21. Remove the [middlecap](#).
22. Remove the [display assembly](#).
23. Remove the [display bezel](#).
24. Remove the [display panel](#).
25. Remove the [P-sensor](#).

About this task

The figure indicates the location of the display cable and provides a visual representation of the removal procedure.

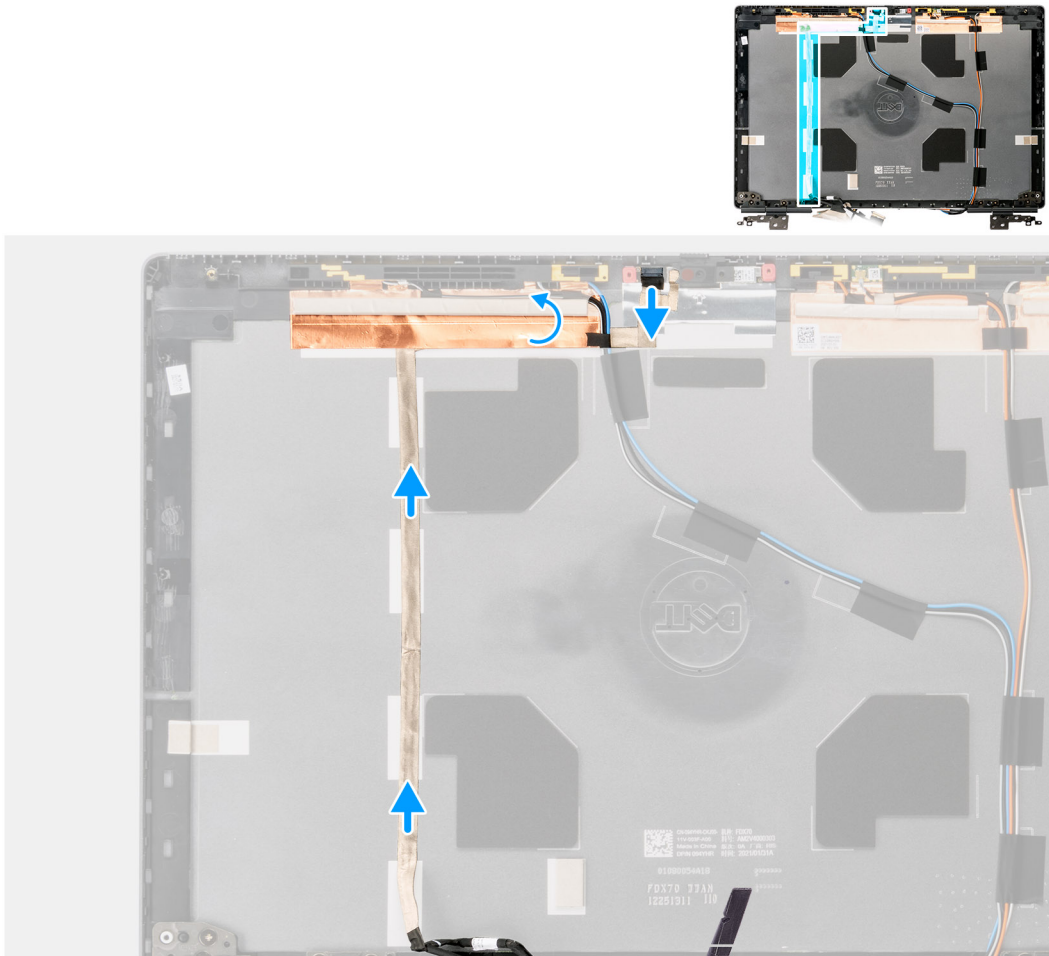

Steps

1. Peel the adhesive tape covering the camera module.
2. Disconnect the display cable from the camera module.
3. Peel the display cable from the display cover and unrout the cable from the routing channels.
4. Remove the display cable from the display back cover.

Installing the display cable

Prerequisites

If you are replacing a component, remove the existing component before performing the installation procedure.

About this task

The figure indicates the display cable and provides a visual representation of the installation procedure.

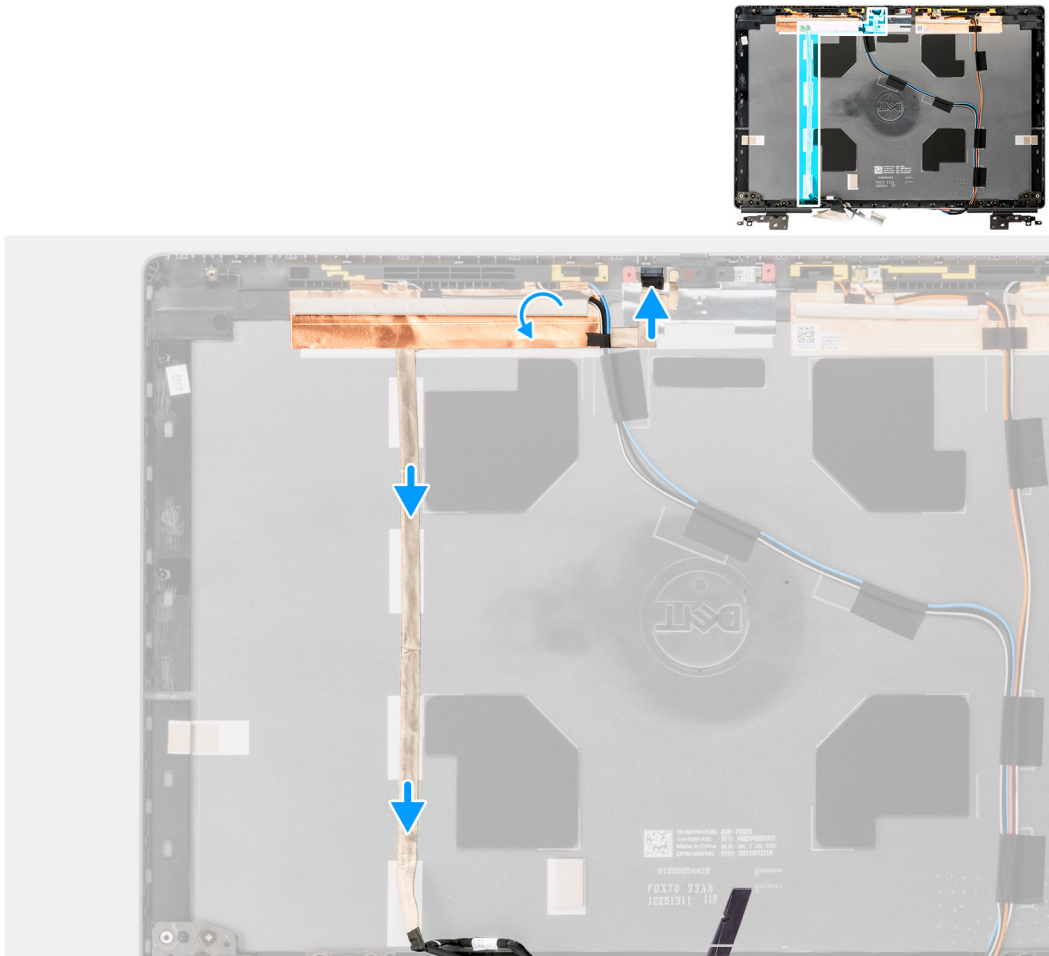

Steps

1. Route and adhere the display cable on the display back cover.
2. Connect the display cable to the connector on the camera module.
3. Adhere the adhesive tape to cover the camera module.

Next steps

1. Install the [P-sensor](#).
2. Install the [display panel](#).
3. Install the [display bezel](#).
4. Install the [display assembly](#).
5. Install the [middlecap](#).
6. Install the [speakers](#).
7. Install the [system board](#).
8. Install the [inner frame](#).
9. Install the [heat-sink assembly](#).
10. Install the [GPU card](#).
11. Install the [GPU power cable](#).
12. Install the [SD card reader](#).
13. Install the [keyboard](#).
14. Install the [keyboard lattice](#).
15. Install the [SIM card](#).
16. Install the [primary memory](#).
17. Install the [WWAN card](#).
18. Install the [WLAN card](#).

19. Install the [secondary memory](#).
20. Install the [primary M.2 SSD](#).
21. Install the [battery](#).
22. Install the [base cover](#).
23. Install the [secondary M.2 SSD](#).
24. Install the [SD card](#).
25. Follow the procedure in [after working inside your computer](#).

Display back cover

Replacing the display back cover

Prerequisites

1. Follow the procedure in [before working inside your computer](#).
2. Remove the [SD card](#).
3. Remove the [secondary M.2 SSD](#).
4. Remove the [base cover](#).
5. Remove the [battery](#).
6. Remove the [SIM card](#).
7. Remove the [secondary memory](#).
8. Remove the [WLAN card](#).
9. Remove the [WWAN card](#).
10. Remove the [primary M.2 SSD](#).
11. Remove the [keyboard lattice](#).
12. Remove the [keyboard](#).
13. Remove the [SD card reader](#).
14. Remove the [GPU power cable](#).
15. Remove the [GPU card](#).
16. Remove the [primary memory](#).
17. Remove the [heat-sink assembly](#).
18. Remove the [inner frame](#).
19. Remove the [system board](#).
20. Remove the [speakers](#).
21. Remove the [middlecap](#).
22. Remove the [display assembly](#).
23. Remove the [display bezel](#).
24. Remove the [display panel](#).
25. Remove the [P-sensor](#).
26. Remove the [display hinge](#).
27. Remove the [camera shutter cap](#).
28. Remove the [camera](#).
29. Remove the [display cable](#).

About this task

The picture below shows the display back cover after performing the pre-removal parts procedures for any display back cover replacement.

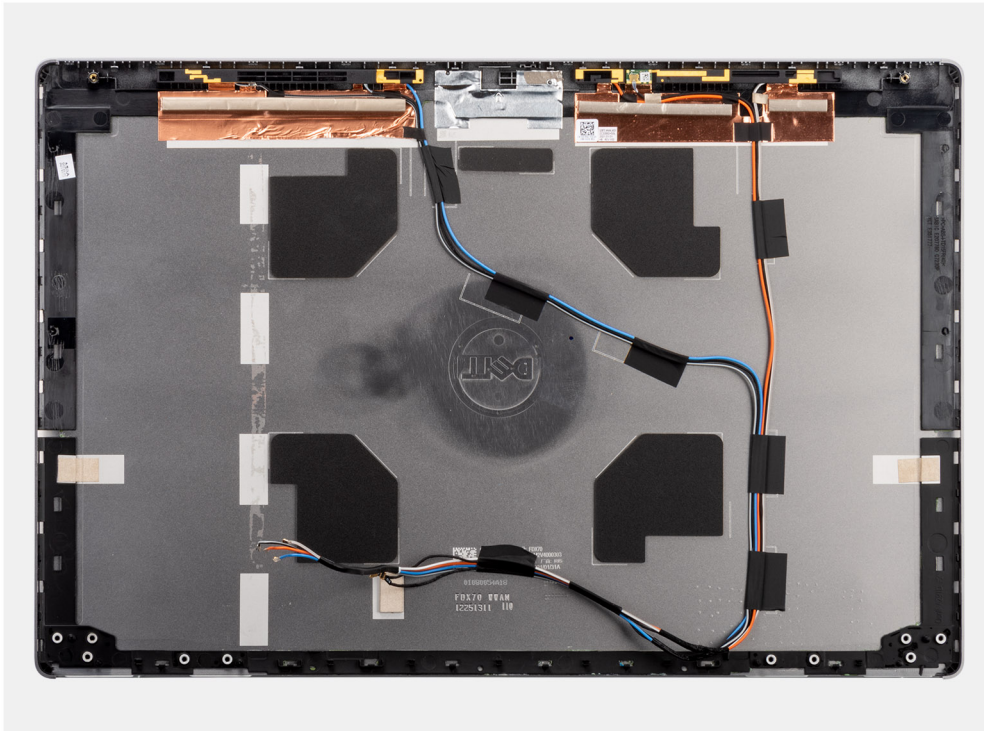

For installing the components, place the display back cover on a flat surface.

1. Install the [display cable](#).
2. Install the [camera](#).
3. Install the [camera shutter cap](#).
4. Install the [display hinge](#).
5. Install the [P-sensor](#).
6. Install the [display panel](#).
7. Install the [display bezel](#).
8. Install the [display assembly](#).
9. Install the [middlecap](#).
10. Install the [speakers](#).
11. Install the [system board](#).
12. Install the [inner frame](#).
13. Install the [heat-sink assembly](#).
14. Install the [GPU card](#).
15. Install the [GPU power cable](#).
16. Install the [SD card reader](#).
17. Install the [keyboard](#).
18. Install the [keyboard lattice](#).
19. Install the [SIM card](#).
20. Install the [primary memory](#).
21. Install the [WWAN card](#).
22. Install the [WLAN card](#).
23. Install the [secondary memory](#).
24. Install the [primary M.2 SSD](#).
25. Install the [battery](#).
26. Install the [base cover](#).
27. Install the [secondary M.2 SSD](#).
28. Install the [SSD door](#).
29. Install the [SD card](#).
30. Follow the procedure in [after working inside your computer](#).

Drivers and downloads

When troubleshooting, downloading, or installing drivers, it is recommended that you read the Dell knowledge base article, [Drivers and Downloads FAQs](#) .

BIOS setup

CAUTION: Unless you are an expert computer user, do not change the settings in the BIOS Setup program. Certain changes can make your computer work incorrectly.

NOTE: Depending on the computer and its installed devices, the items listed in this section may or may not be displayed.

NOTE: Before you change BIOS Setup program, it is recommended that you write down the BIOS Setup program screen information for future reference.

Use the BIOS Setup program for the following purposes:

- Get information about the hardware installed in your computer, such as the amount of RAM and the size of the hard drive.
- Change the system configuration information.
- Set or change a user-selectable option, such as the user password, type of hard drive installed, and enabling or disabling base devices.

Topics:

- [BIOS overview](#)
- [Entering BIOS setup program](#)
- [Navigation keys](#)
- [Boot Sequence](#)
- [BIOS setup options](#)
- [Updating the BIOS in Windows](#)
- [Updating the Dell BIOS in Linux and Ubuntu environments](#)
- [One time boot menu](#)
- [Flashing the BIOS from the F12 One-Time boot menu](#)
- [System and setup password](#)
- [Clearing BIOS \(System Setup\) and System passwords](#)

BIOS overview

The BIOS manages data flow between the computer's operating system and attached devices such as hard disk, video adapter, keyboard, mouse, and printer.

Entering BIOS setup program

Steps

1. Turn on your computer.
2. Press F2 immediately to enter the BIOS setup program.

NOTE: If you wait too long and the operating system logo appears, continue to wait until you see the desktop. Then, turn off your computer and try again.

Navigation keys

NOTE: For most of the System Setup options, changes that you make are recorded but do not take effect until you restart the system.

Table 4. Navigation keys

Keys	Navigation
Up arrow	Moves to the previous field.
Down arrow	Moves to the next field.
Enter	Selects a value in the selected field (if applicable) or follow the link in the field.
Spacebar	Expands or collapses a drop-down list, if applicable.
Tab	Moves to the next focus area.  NOTE: For the standard graphics browser only.
Esc	Moves to the previous page until you view the main screen. Pressing Esc in the main screen displays a message that prompts you to save any unsaved changes and restarts the system.

Boot Sequence

Boot Sequence allows you to bypass the System Setup–defined boot device order and boot directly to a specific device (for example: optical drive or hard drive). During the Power-on Self Test (POST), when the Dell logo appears, you can:

- Access System Setup by pressing F2 key
- Bring up the one-time boot menu by pressing F12 key

The one-time boot menu displays the devices that you can boot from including the diagnostic option. The boot menu options are:

- Removable Drive (if available)
- STXXXX Drive (if available)
 **NOTE:** XXX denotes the SATA drive number.
- Optical Drive (if available)
- SATA Hard Drive (if available)
- Diagnostics

The boot sequence screen also displays the option to access the System Setup screen.

BIOS setup options

 **NOTE:** Depending on this computer and its installed devices, the items listed in this section may or may not appear.

Table 5. BIOS setup options—System information menu

General-System Information	
System Information	
BIOS Version	Displays the BIOS version number.
Service Tag	Displays the Service Tag of the computer.
Asset Tag	Displays the Asset Tag of the computer.
Ownership Tag	Displays the ownership tag of the computer.
Manufacturing Date	Displays the manufacture date of the computer.
Ownership Date	Displays the ownership date of the computer.
Express Service Code	Displays the express service code of the computer.
Memory Information	

Table 5. BIOS setup options—System information menu (continued)

General-System Information	
Memory Installed	Displays the total computer memory installed.
Memory Available	Displays the total computer memory available.
Memory Speed	Displays the memory speed.
Memory Channel Mode	Displays single or dual channel mode.
Memory Technology	Displays the technology used for the memory.
DIMM A Size	Displays the DIMM A memory size.
DIMM B Size	Displays the DIMM B memory size.
DIMM C Size	Displays the DIMM C memory size.
DIMM D Size	Displays the DIMM D memory size.
DIMM A_CPUUn	Displays the DIMM A memory size for a multi-socket system
DIMM B_CPUUn	Displays the DIMM B memory size for a multi-socket system
DIMM C_CPUUn	Displays the DIMM C memory size for a multi-socket system
DIMM D_CPUUn	Displays the DIMM D memory size for a multi-socket system
Processor Information	
Processor Type	Displays the processor type.
Core Count	Displays the number of cores on the processor.
Processor ID	Displays the processor identification code.
Current Clock Speed	Displays the current processor clock speed.
Minimum Clock Speed	Displays the minimum processor clock speed.
Maximum Clock Speed	Displays the maximum processor clock speed.
Processor L2 Cache	Displays the Processor L2 cache size, unit is KB.
Processor L3 Cache	Displays the Processor L3 cache size, unit is KB.
HT Capable	Displays whether the processor is HyperThreading (HT) capable.
64-Bit Technology	Displays whether 64-bit technology is used.
PCIe Information	
SLOT1, SLOT2, SLOT3, SLOTn	Displays the class information of installed PCI/PCIE devices
SLOT1_M.2, SLOT2_M.2, SLOTn_M.2	Displays the class information of installed PCI SSD Device Class/(SATA Installed) devices
Device Information	
ATA device information has the following options:	Displays the device size of each port, unit in GB
<ul style="list-style-type: none"> ● SATA-0 ● SATA-1 ● SATA-2 ● SATA-n ● eSATA-0 ● M.2 PCIe SSD-0 ● M.2 PCIe SSD-n 	
SAS device info has the following options:	Displays the device size of each SAS port, unit in GB
<ul style="list-style-type: none"> ● SAS-0 ● SAS-1 ● SAS-2 ● SAS-3 	

Table 5. BIOS setup options—System information menu (continued)

General-System Information	
Primary HDD	Displays the primary hard drive information of the computer.
MiniCard SSD Device	Displays the MiniCard SSD device information of the computer.
Modular Bay Device	Displays the Modular Bay device information of the computer.
System eSATA Device	Displays the System eSATA device information of the computer.
ODD Device	Displays the ODD device information of the computer.
Dock eSATA Device	Displays the Dock eSATA device information of the computer.
LOM MAC Address	Displays the LOM MAC address of the computer.
SFP NIC MAC Address	Displays the SFP NIC MAC address of the computer.
Managed LOM MAC Address	Displays the Managed LOM MAC address of the computer.
Video Controller	Displays the video controller type of the computer.
dGPU Video Controller	Displays the discrete graphics information of the computer.
Video BIOS Version	Displays the video BIOS version of the computer.
Video Memory	Displays the video memory information of the computer.
Panel Type	Displays the Panel Type of the computer.
Native Resolution	Displays the native resolution of the computer.
Audio Controller	Displays the audio controller information of the computer.
Wi-Fi Device	Displays the wireless device information of the computer.
WiGig Device	Displays the WiGig device information of the computer.
Bluetooth Device	Displays the bluetooth device information of the computer.
Passthrough MAC Address	Displays the unique MAC address information of the computer.
Battery Information	Displays the battery health, charging state and AC adapter information.
Boot Sequence	
Boot Sequence	Displays the boot sequence.
Boot List Option	Displays the available boot options.
Advanced Boot Options	
Enable Legacy Option ROMs	Enable or disable the Legacy Option ROMs.
Enable UEFI Network Stack	Enable or disable the integrated NIC.
Enable Attempt Legacy Boot	Enable or disable Legacy Boot. When enabled, if the system fails to boot the UEFI Boot List, the system will immediately attempt to boot the Legacy Boot List. This feature requires Legacy Option ROMs to be enabled and cannot be used with Secure Boot enabled
UEFI Boot Path Security	Enable or disable the system to prompt the user to enter the Admin password when booting a UEFI boot path from the F12 boot menu.
Date/Time	Displays the current date in MM/DD/YY format and current time in HH:MM:SS AM/PM format.

Table 6. System setup options—System Configuration menu

System Configuration	
Integrated NIC	Controls the on-board LAN controller.
Enable UEFI Network Stack	Enable or disable UEFI Network Stack.
SATA Operation	Configure operating mode of the integrated SATA hard drive controller.
Drives	Enable or disable various drives on board.

Table 6. System setup options—System Configuration menu (continued)

System Configuration	
SMART Reporting	Enable or disable SMART Reporting during system startup.
USB Configuration	
Enable USB Boot Support	Enable or disable booting from USB mass storage devices such as external hard drive, optical drive, and USB drive.
Enable External USB Port	Enable or disable booting from USB mass storage devices connected to external USB port.
Thunderbolt Adapter Configuration	Enable or disable Thunderbolt technology support.
Audio	Enable or disable the integrated audio controller.
USB PowerShare	Enable or disable the USB PowerShare
Touchscreen	Enable or disable the Touchscreen
Unobtrusive Mode	Enable or disable the Unobtrusive mode
Keyboard Illumination	Enables you to choose the operating mode of the keyboard illumination feature.
Keyboard Backlight Timeout on AC	When the backlight is enabled, this feature defines the timeout value for the keyboard backlight when an AC adapter is plugged into the computer.
Keyboard Backlight Timeout on Battery	When the backlight is enabled, this feature defines the timeout value for the keyboard backlight when the computer is running only on battery power.
Miscellaneous Devices	Enable or disable various onboard devices.

Table 7. System setup options—Video menu

Video	
LCD Brightness	Set the panel brightness independently for Battery and AC power.
Switchable Graphics	Allows to switch between the Integrated graphics and the discrete graphics controller.
Primary Video Slot	Allows to set the primary video slot.

Table 8. System setup options—Security menu

Security	
Admin Password	Set, change, or delete the administrator password.
System Password	Set, change, or delete the system password.
Internal HDD-0 Password	Set, change, or delete the internal hard-disk drive password.
eSATA Bay HDD password	Set, change, or delete the eSATA internal hard-disk drive password
eSATA Dock Bay HDD Password	Set, change, or delete the eSATA dock bay internal hard-disk drive password
Device Bay HDD password	Set, change, or delete the device bay internal hard-disk drive password
Strong Password	Enable or disable strong passwords.
Password Configuration	Control the minimum and maximum number of characters allowed for Admin and System passwords.
Password Bypass	Bypass the System (Boot) Password and the internal HDD password prompts during a system restart.
Password Change	Enable or disable changes to the System and Hard Disk passwords when an administrator password is set.
Non-Admin Setup Changes	Determines whether changes to the setup option are permitted when an administrator password is set.
TPM 2.0 Security	Enable or disable Trusted Platform Module (TPM) .
UEFI Capsule Firmware Updates	Enable or disable BIOS updates through UEFI capsule update packages.

Table 8. System setup options—Security menu (continued)

Security	
PTT Security	Enable or disable Platform Trust Technology (PTT) visibility to the operating system.
Absolute I	This field allows you to Enable, Disable, or Permanently Disable the BIOS module interface of the optional Absolute Persistence Module service from Absolute® Software.
OROM Keyboard Access	Allows you to set an option to enter the Option ROM Configuration screens using hotkeys during boot.
SMM Security Mitigation	Allows you to enable or disable additional UEFI SMM Security Mitigation protection.
HDD Security	Enable or disable the HDD Security.
Computrace(R)	Enable or disable the BIOS module interface of the optional Computrace(R) Service from Absolute Software.
Admin Setup Lockout	Enable to prevent users from entering Setup when an Admin Password is set.
Master Password Lockout	Disables the master password support. Hard Disk passwords need to be cleared before changing the setting.

Table 9. System setup options—Secure Boot menu

Secure Boot	
Secure Boot Enable	Enable or disable the secure boot feature.
Secure Boot Mode	Modifies the behavior of Secure Boot to allow evaluation or enforcement of UEFI driver signatures.
Expert Key Management	
Expert Key Management	Enable or disable Expert Key Management.
Custom Mode Key Management	Select the custom values for expert key management.

Table 10. System setup options—Intel Software Guard Extensions menu

Intel Software Guard Extensions	
Intel SGX Enable	Enable or disable Intel Software Guard Extensions.
Enclave Memory Size	Set the Intel Software Guard Extensions Enclave Reserve Memory Size.
Performance	
Multi Core Support	Enable multiple cores. Default: Enabled.
Intel SpeedStep	Enable or disable Intel Speedstep Technology. Default: Enabled. i NOTE: If enabled, the processor clock speed and core voltage are adjusted dynamically based on the processor load.
C-States Control	Enable or disable additional processor sleep states. Default: Enabled.
Intel TurboBoost	Enable or disable Intel TurboBoost mode of the processor. Default: Enabled.
HyperThread control	Enable or disable HyperThreading in the processor. Default: Enabled.
Power Management	

Table 10. System setup options—Intel Software Guard Extensions menu (continued)

Intel Software Guard Extensions	
AC Behavior	Enables the system to turn on automatically, when AC power is supplied.
Enable Intel Speed Shift Technology	Enable or disable Intel Speed Shift Technology.
Auto On Time	Enable to set the computer to turn on automatically every day or on a preselected date and time. This option can be configured only if the Auto On Time is set to Everyday, Weekdays or Selected Days. Default: Disabled.
USB Wake Support	Enable the USB devices to wake the computer from Standby.
Block Sleep	Enable or disable Block Sleep
Peak Shift	Allows you to use battery power instead of AC current during specified times
Advanced Battery Charge Configuration	Enable Advanced Battery Charge Configuration from the beginning of the day to a specified work period.
Primary Battery Charge Configuration	Set the primary battery charge settings with a preselected custom charge start and stop. Default: Adaptive.
Intel Speed Shift Technology	Enable or disable Intel Speed Shift Technology
POST Behavior	
Adapter Warnings	Enable adapter warnings. Default: Enabled.
Numlock Enable	Enables the NumLock function when computer boots.
Fn Lock Options	Enable or disable the Fn lock mode.
Fastboot	Enable to set the speed of the boot process. Default: Thorough.
Extend BIOS POST Time	Configure additional pre-boot delay.
Full Screen Logo	Enable or disable to display full screen logo.
Warnings and Errors	Sets the boot process to pause when Warnings or Errors are detected.
MAC Address Pass-Through	Sets the MAC Address Pass.
Sign of Life Indication	Enable or disable to indicate during POST time that the power button press is acknowledged in a manner the user can either hear or feel.

Table 11. System setup options—Manageability

Manageability	
USB Provision	Enable or disable USB Provision
MEBx Hotkey	Enable or disable MEBx Hotkey
Intel AMT Capability	Disable/Enable/Restrict MEBx Access

Table 12. System setup options—Virtualization Support menu

Virtualization Support	
Virtualization	Specify whether a Virtual Machine Monitor (VMM) can utilize the additional hardware capabilities provided by Intel Virtualization Technology.
VT for Direct I/O	Specify whether a Virtual Machine Monitor (VMM) can utilize the additional hardware capabilities provided by Intel Virtualization Technology for Direct I/O.
Trusted Execution	Specify whether a Measured Virtual Machine Monitor can utilize the additional hardware capabilities provided by Intel Trusted Execution Technology.

Table 13. System setup options—Wireless menu

Wireless	
Wireless Switch	Determine which wireless devices can be controlled by the Wireless Switch.
Wireless Device Enable	Enable or disable internal wireless devices.

Table 14. System setup options—Maintenance menu

Maintenance	
Service Tag	Display the system's Service Tag.
Asset Tag	Create a system Asset Tag.
BIOS Downgrade	Control flashing of the system firmware to previous revisions.
Data Wipe	Enable to securely erase data from all internal storage devices.
BIOS Recovery	Enable the user to recover from certain corrupted BIOS conditions from a recovery file on the user primary hard drive or an external USB key.
First Power On Date	Set Ownership Date

Table 15. System setup options—System Logs menu

System Logs	
BIOS Events	Display BIOS events.
Thermal Events	Display Thermal events.
Power Events	Display Power events.

Table 16. System setup options—SupportAssist System Resolution menu

SupportAssist System Resolution	
Auto OS Recovery Threshold	Control the automatic boot flow for SupportAssist System Resolution Console and for Dell OS Recovery tool.
SupportAssist OS Recovery	Enable or disable the boot flow for SupportAssist OS Recovery tool in the event of certain system errors.
BIOSConnect	Enable or disable BIOSConnect

Updating the BIOS in Windows

Prerequisites





It is recommended to update your BIOS (System Setup), when you replace the system board or if an update is available. For laptops, ensure that your computer battery is fully charged and connected to a power outlet.

About this task

 **NOTE:** If BitLocker is enabled, it must be suspended before updating the system BIOS, and then re-enabled after the BIOS update is completed.

Steps

1. Restart the computer.
2. Go to www.dell.com/support.
 - Enter the **Service Tag** or **Express Service Code** and click **Search**.
 - Click **Drivers & Downloads**.
 - Click **Detect Drivers** and follow the on-screen instructions.
3. If you are unable to detect or find the Service Tag, click **Browse all products**.
4. Choose the appropriate category to reach the product page.

5. Select your computer model, followed by its model number.
 **NOTE:** The **Product Support** page of your computer appears.
6. Click **Drivers & Downloads**.
 **NOTE:** The Drivers & Downloads section is displayed.
7. Click **Category**, and select **BIOS** from the drop-down list.
8. Click the toggle button **Show downloads for only THIS PC XXXXXXXX**.
 **NOTE:** XXXXXXXX denotes the Service Tag.
9. Select the latest BIOS file and click **Download**.
10. After the download is complete, browse to the folder where you saved the system BIOS executable file.
11. Double-click the system BIOS executable file.
 **NOTE:** Follow the on-screen instructions.

Updating BIOS on systems with BitLocker enabled

 **CAUTION:** If BitLocker is not suspended before updating the BIOS, the next time you reboot the system it will not recognize the BitLocker key. You will then be prompted to enter the recovery key to progress and the system will ask for this on each reboot. If the recovery key is not known this can result in data loss or an unnecessary operating system re-install. For more information on this subject, see Knowledge Article: <https://www.dell.com/support/article/sln153694>

Updating your system BIOS using a USB flash drive

About this task

If the computer cannot load into Windows but there is still a need to update the BIOS, download the BIOS file using another computer and save it to a bootable USB flash drive.

 **NOTE:** You must use a bootable USB flash drive. For more information, see the knowledge base article [SLN143196](#).

Steps

1. Download the BIOS update .exe file to another computer.
2. Copy the .exe file onto the bootable USB flash drive.
3. Insert the USB flash drive into the computer that requires the BIOS update.
4. Restart the computer and press F12 when the Dell logo appears to display the One Time Boot Menu.
5. Using arrow keys, select **USB Storage Device** and press Enter.
6. The computer restarts to a Diag C:\> prompt.
7. Run the file by typing the complete filename and press Enter.
8. The BIOS Update Utility is displayed. Follow the on-screen instructions.

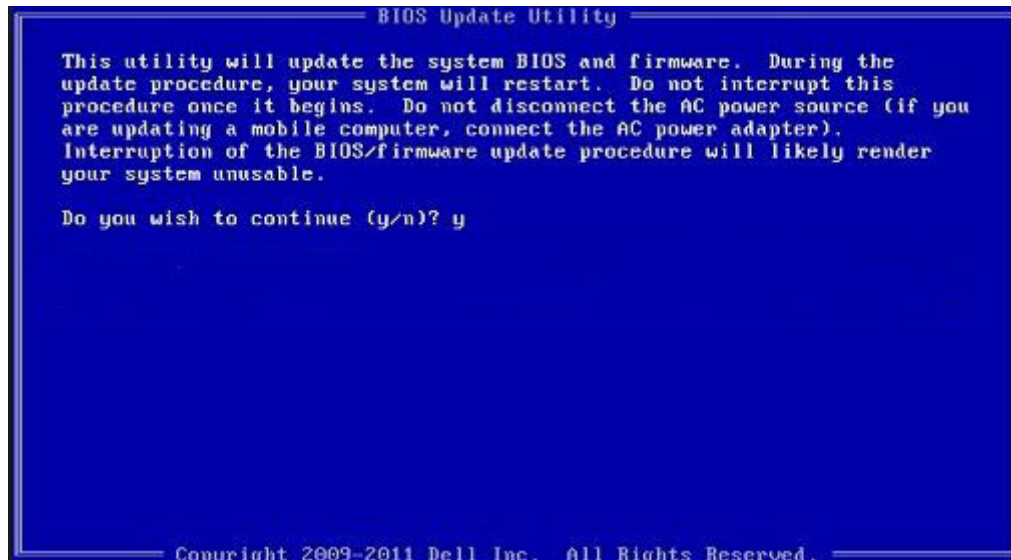

Figure 1. DOS BIOS Update Screen

Updating the Dell BIOS in Linux and Ubuntu environments

If you want to update the system BIOS in a Linux environment such as Ubuntu, see <https://www.dell.com/support/kbdoc/000131486>.

One time boot menu

To enter **one time boot menu**, turn on your computer, and then press F12 immediately.

NOTE: It is recommended to shutdown the computer if it is on.

The one-time boot menu displays the devices that you can boot from including the diagnostic option. The boot menu options are:

- Removable Drive (if available)
- STXXXX Drive (if available)
- **NOTE:** XXX denotes the SATA drive number.
- Optical Drive (if available)
- SATA Hard Drive (if available)
- Diagnostics

The boot sequence screen also displays the option to access the System Setup screen.

Flashing the BIOS from the F12 One-Time boot menu

Update your computer BIOS using the BIOS update.exe file that is copied to a FAT32 USB drive and booting from the F12 One-Time boot menu.

About this task

BIOS Update

You can run the BIOS update file from Windows using a bootable USB drive or you can also update the BIOS from the F12 One-Time boot menu on the computer.

Most of the Dell computers built after 2012 have this capability, and you can confirm by booting your computer to the F12 One-Time Boot Menu to see if BIOS FLASH UPDATE is listed as a boot option for your computer. If the option is listed, then the BIOS supports this BIOS update option.

 **NOTE:** Only computers with BIOS Flash Update option in the F12 One-Time boot menu can use this function.

Updating from the One-Time boot menu

To update your BIOS from the F12 One-Time boot menu, you need the following:

- USB drive formatted to the FAT32 file system (key does not have to be bootable)
- BIOS executable file that you downloaded from the Dell Support website and copied to the root of the USB drive
- AC power adapter that is connected to the computer
- Functional computer battery to flash the BIOS

Perform the following steps to perform the BIOS update flash process from the F12 menu:

 **CAUTION:** Do not turn off the computer during the BIOS update process. The computer may not boot if you turn off your computer.

Steps

1. From a turn off state, insert the USB drive where you copied the flash into a USB port of the computer.
2. Turn on the computer and press F12 to access the One-Time Boot Menu, select BIOS Update using the mouse or arrow keys then press Enter.
The flash BIOS menu is displayed.
3. Click **Flash from file**.
4. Select external USB device.
5. Select the file and double-click the flash target file, and then click **Submit**.
6. Click **Update BIOS**. The computer restarts to flash the BIOS.
7. The computer will restart after the BIOS update is completed.

System and setup password

Table 17. System and setup password

Password type	Description
System password	Password that you must enter to log in to your system.
Setup password	Password that you must enter to access and make changes to the BIOS settings of your computer.

You can create a system password and a setup password to secure your computer.

 **CAUTION:** The password features provide a basic level of security for the data on your computer.

 **CAUTION:** Anyone can access the data that is stored on your computer if it is not locked and left unattended.

 **NOTE:** System and setup password feature is disabled.

Assigning a system setup password

Prerequisites

You can assign a new **System or Admin Password** only when the status is in **Not Set**.

About this task

To enter the system setup, press F12 immediately after a power-on or reboot.

Steps

1. In the **System BIOS** or **System Setup** screen, select **Security** and press Enter.
The **Security** screen is displayed.
2. Select **System/Admin Password** and create a password in the **Enter the new password** field.
Use the following guidelines to assign the system password:
 - A password can have up to 32 characters.
 - The password can contain the numbers 0 through 9.
 - Only lower case letters are valid, upper case letters are not valid.
 - Only the following special characters are valid: Space, ("), (+), (,), (-), (.), (/), (:), ([), (\), (]), (`).
3. Type the system password that you entered earlier in the **Confirm new password** field and click **OK**.
4. Press Esc and a message prompts you to save the changes.
5. Press Y to save the changes.
The computer restarts.

Deleting or changing an existing system setup password

Prerequisites

Ensure that the **Password Status** is Unlocked (in the System Setup) before attempting to delete or change the existing System and/or Setup password. You cannot delete or change an existing System or Setup password, if the **Password Status** is Locked.

About this task

To enter the System Setup, press F12 immediately after a power-on or reboot.

Steps

1. In the **System BIOS** or **System Setup** screen, select **System Security** and press Enter.
The **System Security** screen is displayed.
2. In the **System Security** screen, verify that **Password Status** is **Unlocked**.
3. Select **System Password**, update, or delete the existing system password, and press Enter or Tab.
4. Select **Setup Password**, update, or delete the existing setup password, and press Enter or Tab.
 **NOTE:** If you change the System and/or Setup password, reenter the new password when prompted. If you delete the System and/or Setup password, confirm the deletion when prompted.
5. Press Esc and a message prompts you to save the changes.
6. Press Y to save the changes and exit from System Setup.
The computer restarts.

Clearing BIOS (System Setup) and System passwords

About this task

To clear the system or BIOS passwords, contact Dell technical support as described at www.dell.com/contactdell.

-  **NOTE:** For information on how to reset Windows or application passwords, refer to the documentation accompanying Windows or your application.

Troubleshooting

Topics:

- Built-in self-test (BIST)
- Dell SupportAssist Pre-boot System Performance Check diagnostics
- System-diagnostic lights
- Recovering the operating system
- Backup media and recovery options
- Real Time Clock—RTC reset
- Updating the BIOS in Windows environment
- Updating the BIOS using the USB drive in Windows environment
- WiFi power cycle
- Drain residual flea power (perform hard reset)

Built-in self-test (BIST)

M-BIST

M-BIST (Built In Self-Test) is the system board's built-in self-test diagnostics tool that improves the diagnostics accuracy of system board embedded controller (EC) failures.

NOTE: M-BIST can be manually initiated before POST (Power On Self Test).

How to run M-BIST

NOTE: M-BIST must be initiated on the system from a power-off state either connected to AC power or with battery only.

1. Press and hold both the **M** key on the keyboard and the **power button** to initiate M-BIST.
2. With both the **M** key and the **power button** held down, the battery indicator LED may exhibit two states:
 - a. OFF: No fault detected with the system board
 - b. AMBER: Indicates a problem with the system board
3. If there is a failure with the system board, the battery status LED will flash one of the following error codes for 30 seconds:

Table 18. LED error codes

Blinking Pattern		Possible Problem
Amber	White	
2	1	CPU Failure
2	8	LCD Power Rail Failure
1	1	TPM Detection Failure
2	4	Unrecoverable SPI Failure

4. If there is no failure with the system board, the LCD will cycle through the solid color screens described in the LCD-BIST section for 30 seconds and then power off.

M-BIST

M-BIST (Built In Self-Test) diagnostics tool, featuring improved accuracy in system board failures.

 **NOTE:** M-BIST can be manually initiated before POST (Power On Self Test).

How to run M-BIST

 **NOTE:** M-BIST must be initiated on the system from a power-off state either connected to AC power or with battery only.

1. Press and hold both the **M** key on the keyboard and the **power button** to initiate M-BIST.
2. With both the **M** key and the **power button** held down, the battery indicator LED may exhibit two states:
 - a. OFF: No fault detected with the system board
 - b. AMBER: Indicates a problem with the system board

LCD Power rail test (L-BIST)

L-BIST is an enhancement to the single LED error code diagnostics and is automatically initiated during POST. L-BIST will check the LCD power rail. If there is no power being supplied to the LCD (i.e., the L-BIST circuit fails), the battery status LED will flash either an error code [2,8] or an error code [2,7].

 **NOTE:** If L-BIST fails, LCD-BIST cannot function as no power will be supplied to the LCD.

How to invoke L-BIST Test:

1. Press the power button to start the system.
2. If the system does not start up normally, look at the battery status LED:
 - If the battery status LED flashes an error code [2,7], the display cable may not be connected properly.
 - If the battery status LED flashes an error code [2,8], there is a failure on the LCD power rail of the system board, hence there is no power supplied to the LCD.
3. For cases, when a [2,7] error code is shown, check to see if the display cable is properly connected.
4. For cases when a [2,8] error code is shown, replace the system board.

LCD Built-in Self Test (BIST)

Dell laptops have a built-in diagnostic tool that helps you determine if the screen abnormality you are experiencing is an inherent problem with the LCD (screen) of the Dell laptop or with the video card (GPU) and PC settings.

When you notice screen abnormalities like flickering, distortion, clarity issues, fuzzy or blurry image, horizontal or vertical lines, color fade etc., it is always a good practice to isolate the LCD (screen) by running the Built-In Self Test (BIST).

How to invoke LCD BIST Test

1. Power off the Dell laptop.
2. Disconnect any peripherals that are connected to the laptop. Connect only the AC adapter (charger) to the laptop.
3. Ensure that the LCD (screen) is clean (no dust particles on the surface of the screen).
4. Press and hold **D** key and **Power on** the laptop to enter LCD built-in self test (BIST) mode. Continue to hold the D key, until the system boots up.
5. The screen will display solid colors and change colors on the entire screen to white, black, red, green, and blue twice.
6. Then it will display the colors white, black and red.
7. Carefully inspect the screen for abnormalities (any lines, fuzzy color or distortion on the screen).
8. At the end of the last solid color (red), the system will shut down.

 **NOTE:** Dell SupportAssist Pre-boot diagnostics upon launch, initiates an LCD BIST first, expecting a user intervention confirm functionality of the LCD.

LCD Built-in Self Test (BIST)

Dell laptops have a built-in diagnostic tool that helps you determine if the screen abnormality you are experiencing is an inherent problem with the LCD (screen) of the Dell laptop or with the video card (GPU) and PC settings.

When you notice screen abnormalities like flickering, distortion, clarity issues, fuzzy or blurry image, horizontal or vertical lines, color fade etc., it is always a good practice to isolate the LCD (screen) by running the Built-In Self Test (BIST).

How to invoke LCD BIST Test

1. Power off the Dell laptop.
2. Disconnect any peripherals that are connected to the laptop. Connect only the AC adapter (charger) to the laptop.
3. Ensure that the LCD (screen) is clean (no dust particles on the surface of the screen).
4. Press and hold **D** key and **Power on** the laptop to enter LCD built-in self test (BIST) mode. Continue to hold the D key, until you see color bars on the LCD (screen).
5. The screen will display multiple color bars and change colors on the entire screen to red, green, and blue.
6. Carefully inspect the screen for abnormalities.
7. Press **Esc** key to exit.

 **NOTE:** Dell SupportAssist Pre-boot diagnostics upon launch, initiates an LCD BIST first, expecting a user intervention confirm functionality of the LCD.

Dell SupportAssist Pre-boot System Performance Check diagnostics

About this task

SupportAssist diagnostics (also known as system diagnostics) performs a complete check of your hardware. The Dell SupportAssist Pre-boot System Performance Check diagnostics is embedded with the BIOS and is launched by the BIOS internally. The embedded system diagnostics provides a set of options for particular devices or device groups allowing you to:

- Run tests automatically or in an interactive mode
- Repeat tests
- Display or save test results
- Run thorough tests to introduce additional test options to provide extra information about the failed device(s)
- View status messages that inform you if tests are completed successfully
- View error messages that inform you of problems encountered during testing

 **NOTE:** Some tests for specific devices require user interaction. Always ensure that you are present at the computer terminal when the diagnostic tests are performed.

For more information, see <https://www.dell.com/support/kbdoc/000180971>.

Running the SupportAssist Pre-Boot System Performance Check

Steps

1. Turn on your computer.
2. As the computer boots, press the F12 key as the Dell logo appears.
3. On the boot menu screen, select the **Diagnostics** option.
4. Click the arrow at the bottom left corner.
Diagnostics front page is displayed.
5. Click the arrow in the lower-right corner to go to the page listing.
The items detected are listed.
6. To run a diagnostic test on a specific device, press Esc and click **Yes** to stop the diagnostic test.
7. Select the device from the left pane and click **Run Tests**.
8. If there are any issues, error codes are displayed.
Note the error code and validation number and contact Dell.

System-diagnostic lights

Table 19. System-diagnostic lights

Blinking pattern		Problem description	Suggested resolution
Amber	White		
1	1	TPM detection failure	Replace the system board.
1	2	Unrecoverable SPI Flash Failure	Replace the system board.
1	3	Short in hinge cable tripped OCP1	
1	4	Short in hinge cable tripped OCP2	
1	5	EC unable to program i-Fuse	Replace the system board.
1	6	Generic catch-all for ungraceful EC code flow errors	Disconnect all power source (AC, battery, coin cell) and drain flea power by pressing and holding down power button for 3~5 seconds.
2	1	CPU failure	<ul style="list-style-type: none"> • Run the Dell Support Assist/Dell Diagnostics tool. • If problem persists, replace the system board.
2	2	System board failure (included BIOS corruption or ROM error)	<ul style="list-style-type: none"> • Flash latest BIOS version • If problem persists, replace the system board.
2	3	No memory/RAM detected	<ul style="list-style-type: none"> • Confirm that the memory module is installed properly. • If problem persists, replace the memory module.
2	4	Memory/RAM failure	<ul style="list-style-type: none"> • Reset and swap memory modules among the slots. • If problem persists, replace the memory module.
2	5	Invalid memory installed	<ul style="list-style-type: none"> • Reset and swap memory modules among the slots. • If problem persists, replace the memory module.
2	6	System board/Chipset Error	Replace the system board.
2	7	LCD failure (SBIOS message)	Replace the LCD module.
2	8	LCD failure (EC detection of power rail failure)	Replace the system board.
3	1	CMOS battery failure	<ul style="list-style-type: none"> • Reset the main battery connection.

Table 19. System-diagnostic lights (continued)

Blinking pattern		Problem description	Suggested resolution
Amber	White		
			<ul style="list-style-type: none"> If problem persists, replace the main battery.
3	2	PCI or Video card/chip failure	Replace the system board.
3	4	BIOS Recovery image found but invalid	<ul style="list-style-type: none"> Flash latest BIOS version If problem persists, replace the system board.
3	5	Power rail failure	Replace the system board.
3	6	Flash corruption detected by SBIOS.	<ul style="list-style-type: none"> Press power button for over 25 seconds to do RTC reset. If problem persists, replace the system board. Disconnect all power source (AC, battery, coin cell) and drain flea power by pressing and holding down power button 3~5 seconds to ensure all power are drained. Run "BIOS recovery from USB", and the instructions are in the website Dell support. If problem persists, replace the system board.
3	7	Timeout waiting on ME to reply to HECI message.	Replace the system board
4	1	Memory DIMM power rail failure	<ul style="list-style-type: none"> Reset and swap memory modules among the slots. If problem persists, replace the memory module.
4	2	CPU Power Cable connection issue	<ul style="list-style-type: none"> Run the PSU BIST. If problem persists, replace the system board, power supply or cabling.

NOTE: Blinking 3-3-3 LEDs on Lock LED (Caps-Lock or Num-Lock), Power button LED (without Fingerprint reader), and Diagnostic LED indicates failure to provide input during LCD panel test on Dell SupportAssist Pre-boot System Performance. Check diagnostics.

Recovering the operating system

When your computer is unable to boot to the operating system even after repeated attempts, it automatically starts Dell SupportAssist OS Recovery.

Dell SupportAssist OS Recovery is a standalone tool that is preinstalled in all Dell computers installed with Windows 10 operating system. It consists of tools to diagnose and troubleshoot issues that may occur before your computer boots to the operating system. It enables you to diagnose hardware issues, repair your computer, back up your files, or restore your computer to its factory state.

You can also download it from the Dell Support website to troubleshoot and fix your computer when it fails to boot into their primary operating system due to software or hardware failures.

For more information about the Dell SupportAssist OS Recovery, see *Dell SupportAssist OS Recovery User's Guide* at www.dell.com/support.

Backup media and recovery options

It is recommended to create a recovery drive to troubleshoot and fix problems that may occur with Windows. Dell proposes multiple options for recovering Windows operating system on your Dell PC. For more information, see [Dell Windows Backup Media and Recovery Options](#).

Real Time Clock—RTC reset

The Real Time Clock (RTC) reset function allows you or the service technician to recover the recently launched model systems from **No POST/No Boot/No Power** situations. You can initiate the RTC reset on the system from a power-off state only if it is connected to AC power. Press and hold the power button for 30 seconds. The system RTC reset occurs after you release the power button.

NOTE: If AC power is disconnected from the system during the process or the power button is held longer than 40 seconds, the RTC reset process gets aborted.

The RTC reset will reset the BIOS to defaults, un-provision Intel vPro and reset the system date and time. The following items are unaffected by the RTC reset:

- Service Tag
- Asset Tag
- Ownership Tag
- Admin Password
- System Password
- HDD Password
- Key Databases
- System Logs
- TPM on and TPM Enabled settings are unaffected by RTC Reset and should not cause BitLocker issues

NOTE: The IT administrator's vPro account and password on the system will be un-provisioned. The system needs to go through the setup and configuration process again to reconnect it to the vPro server.

The below items may or may not reset based on your custom BIOS setting selections:

- Boot List
- Enable Legacy Option ROMs
- Secure Boot Enable — Allow BIOS Downgrade

Updating the BIOS in Windows environment

About this task

Follow these steps to update the BIOS:

Steps

1. Turn on your computer.
2. Go to www.dell.com/support.
3. Click **Product support**. In the **Search support** box, enter the Service Tag of your computer, and then click **Search**.

NOTE: If you do not have the Service Tag, use the product ID or manually browse for your computer model.

4. Click **Drivers & Downloads**. Expand **Find drivers**.
5. Select the operating system installed on your computer.

6. Scroll down the page and expand **BIOS**.
7. In the **Category** drop-down list, select **BIOS**.
The latest version of BIOS is displayed.
8. Select the update and click **Download** to download the latest version of the BIOS for your computer.
9. After the download is complete, browse the folder where you saved the BIOS update file.
10. Double-click the BIOS update file icon and follow the on-screen instructions.

Updating the BIOS using the USB drive in Windows environment

Steps

1. Follow the procedure from step 1 to step 8 in "[Updating the BIOS in Windows environment](#)" to download the latest BIOS setup program file.
2. Create a bootable USB drive. For more information, see the knowledge base article [000145519](#) at www.dell.com/support.
3. Copy the BIOS setup program file to the bootable USB drive.
4. Connect the bootable USB drive to the computer that needs the BIOS update.
5. Restart the computer and press **F12** when the Dell logo is displayed on the screen.
6. Boot to the USB drive from the **One Time Boot Menu**.
7. Type the BIOS setup program filename and press **Enter**.
The **BIOS Update Utility** appears.
8. Follow the on-screen instructions to complete the BIOS update.

WiFi power cycle

About this task

If your computer is unable to access the internet due to WiFi connectivity issues a WiFi power cycle procedure may be performed. The following procedure provides the instructions on how to conduct a WiFi power cycle:

 **NOTE:** Some ISPs (Internet Service Providers) provide a modem/router combo device.

Steps

1. Turn off your computer.
2. Turn off the modem.
3. Turn off the wireless router.
4. Wait for 30 seconds.
5. Turn on the wireless router.
6. Turn on the modem.
7. Turn on your computer.

Drain residual flea power (perform hard reset)

About this task

Flea power is the residual static electricity that remains in the computer even after it has been powered off and the battery is removed.

For your safety, and to protect the sensitive electronic components in your computer, you are requested to drain residual flea power before removing or replacing any components in your computer.

Draining residual flea power, also known as a performing a "hard reset", is also a common troubleshooting step if your computer does not power on or boot into the operating system.

To drain residual flea power (perform a hard reset)

Steps

1. Turn off your computer.
2. Disconnect the power adapter from your computer.
3. Remove the base cover.
4. Remove the battery.
5. Press and hold the power button for 20 seconds to drain the flea power.
6. Install the battery.
7. Install the base cover.
8. Connect the power adapter to your computer.
9. Turn on your computer.



 **NOTE:** For more information about performing a hard reset, see the knowledge base article [SLN85632](https://www.dell.com/support) at www.dell.com/support.

Getting help and contacting Dell

Self-help resources

You can get information and help on Dell products and services using these self-help resources:

Table 20. Self-help resources

Self-help resources	Resource location
Information about Dell products and services	www.dell.com
My Dell app	
Tips	
Contact Support	In Windows search, type <code>Contact Support</code> , and press Enter.
Online help for operating system	www.dell.com/support/windows
Access top solutions, diagnostics, drivers and downloads, and learn more about your computer through videos, manuals and documents.	Your Dell computer is uniquely identified by a Service Tag or Express Service Code. To view relevant support resources for your Dell computer, enter the Service Tag or Express Service Code at www.dell.com/support . For more information on how to find the Service Tag for your computer, see Locate the Service Tag on your computer .
Dell knowledge base articles for a variety of computer concerns	<ol style="list-style-type: none"> 1. Go to www.dell.com/support. 2. On the menu bar at the top of the Support page, select Support > Knowledge Base. 3. In the Search field on the Knowledge Base page, type the keyword, topic, or model number, and then click or tap the search icon to view the related articles.

Contacting Dell

To contact Dell for sales, technical support, or customer service issues, see www.dell.com/contactdell.

 **NOTE:** Availability varies by country/region and product, and some services may not be available in your country/region.

 **NOTE:** If you do not have an active Internet connection, you can find contact information about your purchase invoice, packing slip, bill, or Dell product catalog.