

MAVIC 2 ENTERPRISE

Advanced

Quick Start Guide

快速入门指南

快速入門指南

クイックスタートガイド

퀵 스타트 가이드

Kurzanleitung

Guía de inicio rápido

Guide de démarrage rapide

Guida di avvio rapido

Snelstartgids

Guia de início rápido

Guia de Início Rápido

Краткое руководство пользователя

v1.0

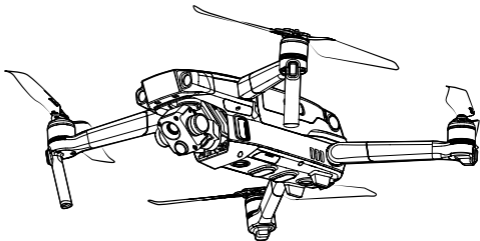

Contents

EN	Quick Start Guide	2
CHS	快速入门指南	11
CHT	快速入門指南	20
JP	クイックスタートガイド	29
KR	퀵 스타트 가이드	38
DE	Kurzanleitung	47
ES	Guía de inicio rápido	56
FR	Guide de démarrage rapide	65
IT	Guida di avvio rapido	74
NL	Snelstartgids	83
PT-PT	Guia de início rápido	92
PT-BR	Guia de Início Rápido	101
RU	Краткое руководство пользователя	110

Aircraft

The DJI™ MAVIC™ 2 Enterprise Advanced features omnidirectional Vision Systems and Infrared Sensing Systems*, and comes with a fully stabilized 3-axis gimbal camera with a thermal camera and a visual camera, providing both infrared and visual images simultaneously. DJI's Obstacle Sensing technology helps users to fly and capture complex shots while AirSense provides awareness of the surrounding airspace and password protection ensures access to the aircraft and all data is secure. The Mavic 2 Enterprise Advanced supports up to 32x digital zoom and has a smoother thermal imaging sensor with a significantly higher resolution as well as a higher pixel visual sensor. The aircraft boasts a maximum flight speed of 44.7 mph (72 kph) and a maximum flight time** of 31 minutes.

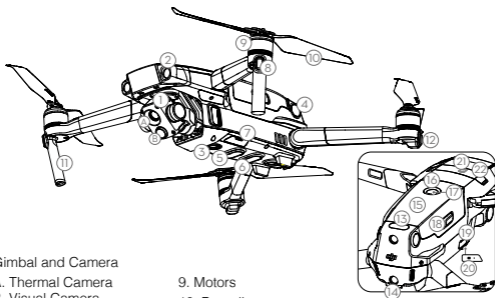

- | | | |
|-------------------------------------|------------------------------------|--|
| 1. Gimbal and Camera | 9. Motors | |
| A. Thermal Camera | 10. Propellers | |
| B. Visual Camera | 11. Antennas | |
| 2. Forward Vision System | 12. Aircraft Status Indicator | 18. Battery Buckles |
| 3. Downward Vision System | 13. Upward Infrared Sensing System | 19. USB-C Port |
| 4. Lateral Vision System | 14. Backward Vision System | 20. Link Button/Linking Status Indicator |
| 5. Downward Infrared Sensing System | 15. Intelligent Flight Battery | 21. Extended Port (to connect accessories) |
| 6. Auxiliary Bottom Light | 16. Battery Level LEDs | 22. Extended Port Cover |
| 7. MicroSD Card Slot | 17. Power Button | |
| 8. Front LEDs | | |

* The Vision Systems and Infrared Sensing Systems are affected by surrounding conditions. Read the Disclaimer and Safety Guidelines and User Manual to learn more. <http://www.dji.com/mavic-2-enterprise-advanced>

** Maximum flight time was tested in an environment with no wind while flying at a consistent 15.5 mph (25 kph). This value is for reference only.

DJI Smart Controller

The DJI Smart Controller is a remote controller built with DJI's long-range transmission technology OCUSYNC™ 2.0, offering a maximum transmission range of 6.2 mi (10 km) and provides a live HD view from the aircraft's camera. The Smart Controller comes with a number of aircraft and gimbal controls as well as customizable buttons and has a built-in 5.5-inch high-brightness screen with multiple functions such as Bluetooth and GNSS. Connection to the Internet via Wi-Fi is also supported. The Smart Controller has a maximum working time of 2.5 hours*.

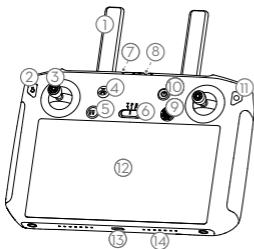

1. Antennas
2. Back Button / Function Button
3. Sticks
4. RTH Button
5. Flight Pause Button
6. Flight Mode Switch
7. Status LED
8. Battery Level LEDs
9. 5D Button
10. Power Button
11. Confirm Button / Customizable Button C3
12. Touch Screen
13. USB-C Port
14. Microphone



15. Gimbal Dial
16. Record Button
17. HDMI Port
18. MicroSD Card Slot
19. USB-A Port
20. Focus / Shutter Button
21. Aperture/Shutter Adjustment Dial

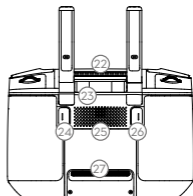

22. Air Vent
23. Sticks Storage Slot
24. Customizable Button C2
25. Speaker
26. Customizable Button C1
27. Air Intake

* The Smart Controller is able to reach its maximum transmission distance (FCC) in a wide-open area with no electromagnetic Interference at an altitude of about 400 ft (120 m). The maximum runtime is tested in a laboratory environment. This value is for reference only.

1. Preparing the Aircraft

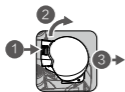

Remove the gimbal cover from the camera.



Unfold the front arms.



Unfold the rear arms.



Marked

Unmarked

Match the propellers to motors.



Press the propellers down and rotate until they click in place.



Unfolded



Unfold the front arms and the propellers before the rear ones. All arms and propellers must be unfolded before takeoff.

2. Charging the Batteries

Use the provided charger to fully charge the Intelligent Flight Battery before first use.

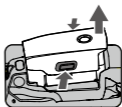

Remove the Intelligent Flight Battery

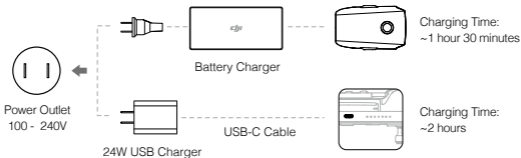

Please use the official 24W USB charger to charge the Smart Controller. When a standard 24W USB charger is not available, it is recommended to use an FCC/CE certified USB charger rated 12V/2A.

• Checking the Battery Levels and Powering On/Off

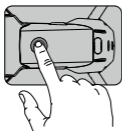

Press once to check the battery level.
Press, then press and hold to turn on/off.

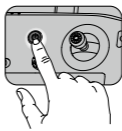

Low High



Press once to check the battery level on the LCD screen.

Press once, then press and hold to turn on/off the remote controller.



Install the battery to the aircraft and power it on. Once the battery temperature is lower than 6° C, it will auto heat to maintain a temperature between 8-10° C. Refer to the User Manual for more details.

3. Preparing the Remote Controller



Lift the antennas



Remove the sticks



Rotate to attach the sticks



The optimal transmission range is shown above. Ensure the antennas are facing towards the aircraft. When the angle between the antennas and the back of the Smart Controller is 80° or 180°, the connection between the Smart Controller and the aircraft can reach its optimal performance.



- Ensure the control sticks are firmly mounted.
- In real operation, the DJI Pilot app will prompt to warn that the transmission signal is weak, and please adjust the antennas to ensure that the aircraft is back to the optimal transmission range.

4. Preparing for Takeoff



Power on the remote controller



Power on the aircraft



Launch DJI Pilot



Internet

Use a DJI account to activate the aircraft and the Smart Controller. Activation requires an internet connection. Before activating the aircraft in DJI Pilot, power on the Smart Controller and follow the prompts to activate.



Set a password for the aircraft in the DJI Pilot app to ensure secure access and protect your onboard data.

5. Flight

Before taking off, make sure the Aircraft Status Bar in DJI Pilot displays "Ready to Go".

Ready to Go (GPS)

• Manual Takeoff / Landing

Combination stick command to start/stop the motors



OR



Left stick up (slowly) to take off



Left stick down (slowly) until you touch the ground
Hold a few seconds to stop the motors



Only stop motors mid-flight in emergency situations when doing so can reduce the risk of damage or injury. The method to stop the motor can be set in DJI Pilot.

• Remote Controller Operation

The default flight control is known as Mode 2. The left stick controls the aircraft's altitude and heading, while the right stick controls its forward, backward, left and right movements. The gimbal dial controls the camera's tilt.

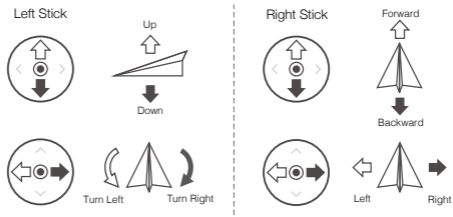

- Always set an appropriate RTH altitude before takeoff. When the aircraft is returning to the Home Point, you should guide it with the control sticks.
- Press the Flight Pause button for emergency braking during flight.

• Modular Accessories



M2E Beacon



M2E Spotlight



M2E Speaker



M2EA RTK Module
(not included)

6. Fly Safe



Fly in Open
Areas



Strong GPS
Signal



Maintain Line of
Sight



Fly Below 400 Feet
(120 m)



Avoid flying over or near obstacles, crowds, high voltage power lines, trees or bodies of water.

DO NOT fly near strong electromagnetic sources such as power lines and base stations as it may affect the onboard compass.



DO NOT use the aircraft in adverse weather conditions such as rain, snow, fog and wind speeds exceeding 10 m/s or 22 mph.



Stay away from the rotating propellers
and motors.



No Fly Zone

Learn more at:
<http://www.dji.com/flysafe>



It's important to understand basic flight guidelines, for the safety of both you and those around you. Don't forget to read the **Disclaimer and Safety Guidelines**.

Specifications

• Aircraft

Takeoff Weight	909 g
Max Speed	72 km/h (S-mode) (near sea level, no wind)
Max Service Ceiling Above Sea Level	6000 m
Operating Temperature Range	14° to 104° F (-10° to 40° C)
GNSS	GPS+GLONASS
Operating Frequency	2.4-2.4835 GHz; 5.725-5.850 GHz
Transmission Power (EIRP)	2.4 GHz FCC: ≤26 dBm; CE/MIC: ≤20 dBm; SRRC: ≤20 dBm 5.8 GHz FCC: ≤26 dBm; CE: ≤14 dBm; SRRC: ≤26 dBm
Internal Storage	24 GB

• Gimbal

Controllable Range	Tilt: -90 to 30°
--------------------	------------------

• Thermal Camera

Sensor	Uncooled VOx Microbolometer
Lens Focal Length	Approx. 9 mm Equivalent: Approx. 38 mm
Sensor Resolution	640×512 @30Hz
Digital Zoom	16x
Pixel Pitch	12 μm
Spectral Band	8-14 μm
Photo	R-JPEG
Video	MP4
Temperature Measurement Method	Spot Meter, Area Measurement

FFC	Auto/Manual
-----	-------------

• Visual Camera

Sensor	1/2" CMOS, Effective pixels: 48 M
Lens	FOV: approx. 84° Equivalent: 24 mm Aperture: f/2.8 Focus: 1 m to ∞
ISO Range	Video: 100-12800 (auto) Photo: 100-1600 (auto)
Max Image Size	8000×6000
Still Photography Modes	Single shot Interval (2/3/5/7/10/15/20/30/60 s) Pano: spherical panorama
Video Recording Modes	3840×2160@30fps 1920×1080@30fps
Photo	JPEG
Video	MP4

• Smart Controller

Operating Frequency	2.400-2.483 GHz; 5.725-5.850 GHz
Max Transmission Distance (unobstructed, free of interference)	FCC: 10 km; CE: 6 km; SRRC: 6 km; MIC: 6 km
Transmitter Power (EIRP)	2.4 GHz FCC: ≤ 25.5 dBm; CE/MIC: ≤ 18.5 dBm; SRRC: ≤ 19 dBm 5.8 GHz FCC: ≤ 25.5 dBm; CE: ≤ 12.5 dBm; SRRC: ≤ 18.5 dBm
Storage Capacity	ROM 16 GB + Scalable (microSD card)
Battery	5000 mAh @ 7.2 V
Operating Temperature Range	-4° to 104° F (-20° to 40° C)
Charging Time	2 hr (with a USB charger at 12V/2A)
Battery Life	2.5 hr
24W USB Charger	Input: 100-240 V, 50-60 Hz, Max. 0.8 A Output: 3.6-8 V \Rightarrow 3.0 A/12 V \Rightarrow 2.0 A

• Intelligent Flight Battery

Capacity	3850 mAh
Voltage	17.6 V (max) 15.4 V (typical)
Battery Type	LiPo
Energy	59.29 Wh
Net Weight	Approx. 297 g
Charging Temperature Range	41° to 104° F (5° to 40° C)
Heating Method	Manual/Auto
Heating Temperature Range	-4° to 43° F (-20° to 6° C)
Heating Time	500 s (max)
Heating Power	55 W (max)

• Intelligent Flight Battery Charger

Input	100-240 V, 50-60 Hz, 1.8 A
Output	Main: 17.6 V \Rightarrow 3.41 A or 17.0 V \Rightarrow 3.53 A USB: 5 V \Rightarrow 2 A
Rated Power	60 W



For more information, read the User Manual:
www.dji.com/mavic-2-enterprice-advanced

※ This content is subject to change without prior notice.

认识 Mavic 2 行业进阶版

MAVIC™ 2 行业进阶版飞行器配备先进的全方位视觉系统及红外传感系统*，可在室内外稳定悬停、飞行，具备自动返航以及障碍物感知功能。飞行器内置 DJI AirSense 可检测周围航空器情况，支持密码保护以保障设备及数据安全，并且可搭载指定配件以适应不同应用场景。进阶版飞行器拥有更高清、流畅的热成像传感器和更高像素的可见光传感器，最高支持 32 倍数码变焦。最大飞行速度为 72 km/h，最长飞行时间** 约为 31 分钟。

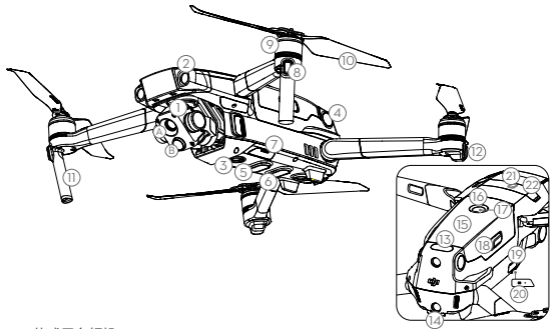

- | | | |
|-------------------|--------------|--------------------------|
| 1. 一体式云台相机 | | |
| A. 红外相机 | | |
| B. 可见光相机 | | |
| 2. 前视视觉系统 | 9. 电机 | 17. 电池开关 |
| 3. 下视视觉系统 | 10. 螺旋桨 | 18. 电池卡扣 |
| 4. 侧视视觉系统 | 11. 天线 | 19. 调参 / 数据接口
(USB-C) |
| 5. 底部红外传感系统 | 12. 飞行器状态指示灯 | 20. 对频按键 / 对频指示灯 |
| 6. 下视补光灯 | 13. 顶部红外传感系统 | 21. 扩展接口(可连接配件) |
| 7. 相机 Micro SD 卡槽 | 14. 后视视觉系统 | 22. 扩展接口保护盖 |
| 8. 飞行器机头指示灯 | 15. 智能飞行电池 | |
| | 16. 电池电量指示灯 | |

* 视觉系统及红外传感系统有使用环境与条件要求，请阅读《免责声明与安全概要》及《用户手册》了解安全注意事项和如何正确使用相关功能。

<http://www.dji.com/mavic-2-enterprise-advanced>

**最长飞行时间为无风环境时以 25 km/h 匀速飞行时测得。

DJI 带屏遥控器

DJI 带屏遥控器采用 OCUSYNC™ 2.0 高清图传技术，配合完备的功能按键可在最大 10 千米 * 通信距离内完成飞行器与相机的操作与设置。遥控器内置 5.5 英寸高亮触摸屏，具备蓝牙及卫星定位等功能，并支持通过 Wi-Fi 连接至互联网。可拆卸摇杆设计更便于遥控器收纳。最长工作时间 * 约为 2.5 小时。

015

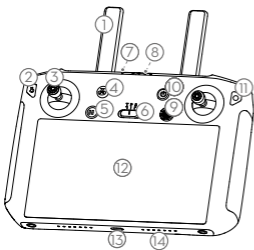

1. 天线
2. 退回按键 / 系统功能按键
3. 摇杆
4. 智能返航按键
5. 急停按键
6. 飞行模式切换开关
7. 状态指示灯
8. 电量指示灯
9. 五维按键
10. 电源按键
11. 确认按键 / 自定义功能按键 C3
12. 触摸显示屏
13. USB-C 接口
14. 麦克风



15. 云台俯仰控制拨轮
16. 录影按键
17. HDMI 接口
18. MicroSD 卡槽
19. USB-A 接口
20. 对焦 / 拍照按键
21. 光圈 / 快门调节拨轮

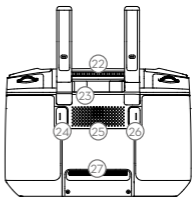

22. 出风口
23. 摇杆收纳槽
24. 自定义功能按键 C2
25. 扬声器
26. 自定义功能按键 C1
27. 入风口

* 在开阔无遮挡、无电磁干扰的环境飞行，并且飞行高度为 120 米左右，在 FCC 标准下遥控器可以达到最大通信距离。最长可工作时间为实验环境下测得，仅供参考。

1. 准备飞行器

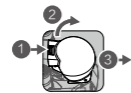

移除云台保护罩



展开前机臂



展开后机臂



白色标记 无标记

匹配标记安装螺旋桨



嵌入桨座按压到底，沿锁紧方向旋转直至弹起锁定



展开状态



请确保按顺序展开机臂，在机臂与桨叶全部展开之后再开启飞行器。

2. 充电

首次使用需给智能飞行电池充满电以激活电池。

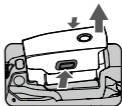

取出智能飞行电池



交流电源
100~240 V



充电器



完全充满约需
1小时30分钟



USB-C 连接线



完全充满约需
2小时



请使用官方 24W USB 充电器对带屏遥控器进行充电。如不使用官方充电器，推荐使用符合 FCC/CE 标准，规格为 12V/2A 的 USB 充电器。

·检查电量与开启 / 关闭

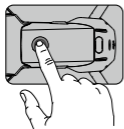

短按一次检查电量。

短按一次，再长按 2 秒可开启、关闭飞行器。

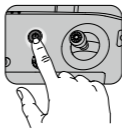

低 ————— 高



短按一次电源按钮查看电量。

短按一次电源按钮，再长按 2 秒以开启、关闭遥控器。



安装电池至飞行器后并开启电源后，一旦电池温度低于 6°C，电池将开启自动加热功能，保持电池温度在 8-10°C 之间。详细内容请参考用户手册。

3. 准备遥控器



向上抬起天线



取出摇杆



安装摇杆



获取最佳通信范围，遥控器与飞行器的相对位置如图所示，当天线与遥控器背面呈 80° 或 180° 夹角时，且天线平面正对飞行器，可让遥控器与飞行器的信号质量达到最佳状态。



- 注意将摇杆拧紧，确保安装到位。
- 实际操作中，DJI Pilot App 在图传信号不佳时将会进行提示，请根据提示调整天线位置，确保飞行器处于最佳通信范围。

4. 准备飞行



开启遥控器



开启飞行器



运行 DJI Pilot App



全新的设备需激活才能使用。请先开启遥控器并根据提示完成激活，再使用 DJI Pilot App 激活飞行器。激活时请确保设备可以接入互联网。



可在 DJI Pilot App 中对飞行器设置安全密码以保证飞行器的使用安全。

5. 飞行

起飞前请务必等待 DJI Pilot App 相机界面显示“起飞准备完毕”。

起飞准备完毕 (GPS)

- 手动起飞 / 降落
- 摇杆动作：
- 电机启动 / 停止



起飞：
缓慢向上推动油门杆（默认左摇杆）飞行器起飞。



降落：
向下拉动油门杆至飞行器落地，在最低位置保持 2 秒，电机停止。



飞行过程中若遇到紧急情况，可执行摇杆动作停止电机以减少伤害，电机紧急停机方式可在 DJI Pilot App 中进行设置。

• 遥控器操作

遥控器出厂默认操控方式为“美国手”。左摇杆控制飞行高度与方向，右摇杆控制飞行器的前进、后退以及左右飞行方向。云台俯仰控制拨轮可控制相机的俯仰拍摄角度。

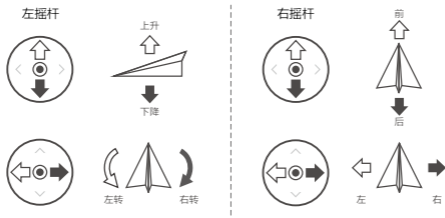

- 请预先在 DJI Pilot App 设置合适的自动返航高度。
- 飞行过程中遇到需要紧急刹车的情况，请按急停按键使飞行器悬停。

* 可扩展配件



M2E 夜航灯



M2E 探照灯



M2E 喊话器



M2EA RTK 模块
(需自行购买)

6. 飞行安全



在开阔无遮挡
的环境中飞行

+



GPS信号良好

+



在目视范围内飞行

+



控制飞行高
度低于120米



飞行时请远离人群、树木、电线、高大建筑物、机场和信号发射塔等。无线电发射塔、高压线、变电站以及具有磁性的大块金属可能会对遥控信号及指南针产生干扰，威胁飞行安全。



下雨、大雾、下雪、雷电、大风（风速每秒10米及以上）等天气请勿飞行。



切勿接触旋转中的螺旋桨，
否则可能受到严重人身财产损害。



禁飞区

详情请访问以下网址：
<http://www.dji.com/flysafe>



禁飞区、飞行安全认识对于您、周围人群与环境的安全非常重要。
请务必仔细阅读《免责声明和安全概要》。

规格参数

• 飞行器

起飞重量	909 g
最大水平飞行速度	72 km/h (运动模式, 海平面附近无风环境)
最大飞行海拔高度	6000 m
工作环境温度	-10℃至 40℃
GNSS	GPS+GLONASS
工作频率	2.4-2.4835 GHz; 5.725-5.850 GHz
发射功率 (EIRP)	2.4 GHz FCC: ≤26 dBm; CE/MIC: ≤20 dBm; SRRC: ≤20 dBm

机载内存

5.8 GHz FCC: ≤26 dBm; CE: ≤14 dBm; SRRC: ≤26 dBm
24 GB

• 云台

可控转动范围	俯仰: -90° 至 +30°
--------	-----------------

• 红外相机

传感器	非制冷氧化钒微测辐射热计
镜头焦距	约 9 mm 等效焦距: 约 38 mm

传感器分辨率	640 × 512 @30Hz
--------	-----------------

数字变焦	16×
------	-----

像元间距	12 μm
------	-------

波长范围	8-14 μm
------	---------

照片格式	R-JPEG
------	--------

视频格式	MP4
------	-----

测温方式	点测温, 区域测温
------	-----------

FFC	自动 / 手动
-----	---------

• 可见光相机

影像传感器	1/2 英寸 CMOS; 有效像素 4800 万
-------	--------------------------

镜头	视角: 约 84° 等效焦距: 24 mm 光圈: f/2.8
----	---------------------------------------

	对焦点: 1 m 至无穷远
--	---------------

ISO 范围	视频: 100-12800 (自动)
--------	--------------------

	照片: 100-1600 (自动)
--	-------------------

最大照片尺寸	8000 × 6000
--------	-------------

照片拍摄模式	单张拍摄 定时拍摄: 2/3/5/7/10/15/20/30/60 s 全景: 球形拍摄
--------	--

录像分辨率	3840 × 2160@30fps
-------	-------------------

	1920 × 1080@30fps
--	-------------------

图片格式	JPEG
------	------

视频格式	MP4
------	-----

• 遥控器

工作频率	2.400-2.483 GHz; 5.725-5.850 GHz
------	----------------------------------

最大信号有效距离 (无干扰、无遮挡)	FCC: 10 km; CE: 6 km; SRRC: 6 km; MIC: 6 km
--------------------	---

等效全向辐射功率 (EIRP)	2.4 GHz FCC: ≤25.5 dBm; CE/MIC: ≤18.5 dBm; SRRC: ≤19 dBm
-----------------	---

5.8 GHz FCC: ≤25.5 dBm; CE: ≤12.5 dBm; SRRC: ≤18.5 dBm

存储空间	ROM 16GB + microSD 卡可扩展存储空间
电池	5000 mAh @ 7.2 V
工作环境温度	-20°C 至 40°C
充电时间	2 小时 (使用规格为 12V/2A 的 USB 充电器)
续航时间	2.5 小时
24W USB 充电器	输入: 100-240 V, 50-60 Hz, 最大 0.8 A 输出: 3.6-8 V \approx 3.0 A/12 V \approx 2.0 A
• 智能飞行电池	
容量	3850 mAh
电压	17.6 V (满充电压) 15.4 V (典型电压)
电池类型	LiPo
能量	59.29 Wh
电池整体重量	约 297 g
充电环境温度	5°C 至 40°C
加热方式	手动加热, 自动加热
加热温度	-20°C 至 6°C
加热时间	500 s (最大)
加热功率	55 W (最大)
• 智能飞行电池充电器	
输入	100-240 V, 50-60 Hz, 1.8 A
输出	主路: 17.6 V \approx 3.41 A 或 17.0 V \approx 3.53 A USB: 5 V \approx 2 A
额定功率	60 W



了解产品详细信息, 请访问以下网址下载《用户手册》

www.dji.com/mavic-2-enterprice-advanced

※ 内容如有更新, 恕不另行通知。

MAVIC 是大疆创新的商标。

Copyright © 2021 大疆创新 版权所有

Printed in China.

認識 MAVIC 2 企業進階版

MAVIC™ 2 企業進階版航拍機配備先進的全方位視覺系統及紅外線感應系統*，可在室內外穩定懸停、飛行，具備自動返航以及障礙物感應功能。航拍機內建 DJI AirSense 可檢測周圍航空器情況，支援密碼保護以保障設備及資料安全，並且可搭載指定配件以適應不同的應用場景。進階版航拍機擁有更高解析、流暢的熱成像感測器和更高畫素的可見光感測器，最高支援 32 倍數位變焦。最大飛行速度為每小時 72 公里，最長飛行時間**約 31 分鐘。

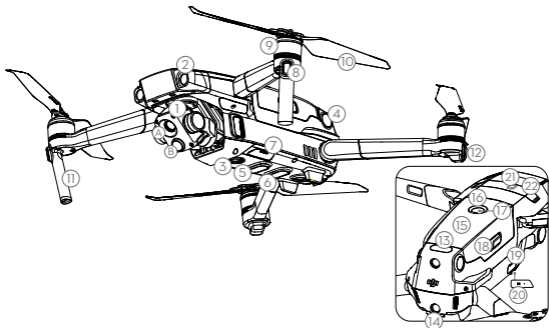

- | | | |
|------------------------------------|---------------|---------------------------|
| 1. 整合式雲台相機
A. 紅外線相機
B. 可見光相機 | 8. 航拍機機頭指示燈 | 17. 電池開關 |
| 2. 前視視覺系統 | 9. 馬達 | 18. 電池卡扣 |
| 3. 下視視覺系統 | 10. 螺旋槳 | 19. 調參 / 數據連接埠
(USB-C) |
| 4. 側視視覺系統 | 11. 天線 | 20. 配對按鈕 / 配對指示燈 |
| 5. 底部紅外線傳感系統 | 12. 航拍機狀態指示燈 | 21. 擴充接頭 (可連接配件) |
| 6. 補光燈 | 13. 頂部紅外線傳感系統 | 22. 擴充接頭保護蓋 |
| 7. 相機 Micro SD 卡插槽 | 14. 後視視覺系統 | |
| | 15. 智能飛行電池 | |
| | 16. 電池電量指示燈 | |

* 視視覺系統及紅外線傳感系統有使用環境與條件方面的要求，請閱讀《免責聲明與安全總覽》及《使用者手冊》以了解安全注意事項和如何正確使用相關功能。

<http://www.dji.com/mavic-2-enterprise-advanced>

** 最長飛行時間是在無風環境下，以 25 km/h 等速飛行測得。

DJI 附螢幕遙控器

DJI 附螢幕遙控器採用 OCUSSYNC™ 2.0 高解析圖像傳遞技術，配合完備的功能按鍵，可在最大 10 公里* 通訊距離內完成空拍機與相機的操作與設置。遙控器內置 5.5 英寸高亮度觸控螢幕，具備藍牙及衛星定位等功能，並支援 Wi-Fi 連線至網際網路。可拆卸搖桿設計更有利於遙控器收納。最長運轉時間* 約為 2.5 小時。

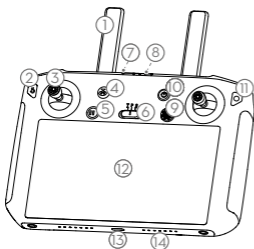

1. 天線
2. 退回按鍵 / 系統功能按鍵
3. 搖桿
4. 智慧返航按鈕
5. 急停按鈕
6. 飛行模式切換開關
7. 狀態指示燈
8. 電量指示燈
9. 五維按鈕
10. 電源按鈕
11. 確認按鍵 / 自訂功能按鍵 C3
12. 觸控螢幕
13. USB-C 連接埠
14. 麥克風
15. 雲台俯仰控制轉盤



16. 錄影按鈕
17. HDMI 連接埠
18. MicroSD 卡插槽
19. USB-A 連接埠
20. 對焦 / 拍照按鈕
21. 光圈 / 快門調節撥輪

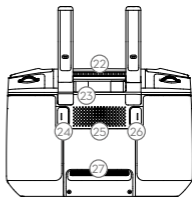

22. 出風口
23. 搖桿收納槽
24. 自訂功能按鍵 C2
25. 喇叭
26. 自訂功能按鍵 C1
27. 入風口

* 若在開闊無遮擋、無電磁干擾的環境下，於高度 120 公尺左右飛行時，遙控器即可依據 FCC 標準達到最大通訊距離。最長運作時間為實驗環境下測得，僅供參考。

1. 準備航拍機

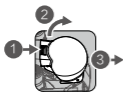

移除雲台保護罩



展開前機臂



展開後機臂



白色標記 無標記

匹配标记安装螺旋桨



嵌入槳座並按壓到底，沿鎖緊方向旋轉直到彈起鎖定



展開狀態



請確保按順序展開機臂，在機臂與槳葉全部展開之後再開啟航拍機。

2. 充電

首次使用時，必須為智能飛行電池充電以啟動電池。

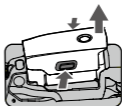

取出智能飛行電池

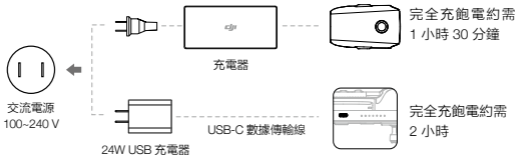

使用官方 24W USB 充電器連接附螢幕遙控器進行充電。如不使用官方充電器，推薦使用符合 FCC/CE 標準，規格為 12V/2A 的 USB 充電器。

• 檢查電量與開啓 / 關閉

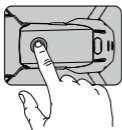

短按一次檢查電量。
短按一次，再長按 2 秒可開啟、
關閉航拍機。

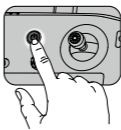

短按一次電源按鈕以查看電量。
短按一次電源按鈕，再長按 2 秒以開啟、
關閉遙控器。

 在航拍機上安裝電池並開啟電源後，一旦電池溫度低於 6°C，電池將開啟自動加熱功能，讓電池溫度保持在 8 - 10°C 之間。詳細內容請參閱使用者手冊。

3. 準備遙控器



向上抬起天線



取出搖桿



安裝搖桿



取得最佳通訊範圍，遙控器與空拍機的相對位置如圖所示，當天線與遙控器背面呈 80° 或 180° 夾角時，且天線平面正對空拍機，可讓遙控器與空拍機的訊號品質達到最佳狀態。



- 注意將搖桿鎖緊，以確保安裝到位。
- 實際操作中，DJI Pilot App 在圖傳訊號不佳時將會進行提示，請根據提示調整天線位置，確保空拍機處於最佳通訊範圍。

4. 準備飛行



開啟遙控器



開啟航拍機



執行 DJI Pilot App
應用程式



全新的設備需啟動才能使用。請先開啓遙控器並根據提示完成啟動，再使用 DJI Pilot App 啟動空拍機。啟動時請確認設備已連線至網際網路。



可在 DJI Pilot 應用程式中設定航拍機安全密碼以確保航拍機的使用安全。

5. 飛行

起飛前，請務必等待 DJI Pilot 應用程式相機介面顯示「起飛準備完畢」(起飞准备完毕)。

起飛準備完畢 (GPS)

• 手動起飛 / 降落

綜合控制桿指令：

馬達啟動 / 停止



或



起飛：
緩慢向上推動油門桿 (預設左搖桿) 使航拍機起飛。



降落：
向下拉動油門桿至航拍機落地，在最低位置保持 2 秒，馬達接著停止。



飛行過程中如遇緊急情況，可執行掰杆動作停止電機以減少損傷，可在 DJI Pilot App 中設定電機緊急停機方式。

遙控器操作

遙控器出廠預設操控方式為「美國手」。左搖桿控制飛行高度與方向，右搖桿控制航拍機的前進、後退以及左右飛行方向。雲台俯仰控制轉盤可控制相機的俯仰拍攝角度。

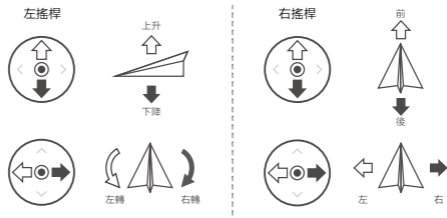

- 請預先在 DJI Pilot App 設置合適的自動返航高度。
- 飛行過程中遇到需要緊急制車的情況，請按急停按鍵使飛行器懸停。

* 擴充配件



M2E 夜航燈



M2E 探照燈



M2E 擴音器



M2EA RTK 模組
(需自行購買)

6. 飛行安全



在開闊無遮蔽
的環境中飛行

+



GPS 訊號良好

+



在視線範圍內
飛行

+



將飛行高度控制在
120 公尺以下



飛行時請遠離人群、樹木、電線、高大建築物、機場和訊號發射塔等。無線電發射塔、高壓線、變電站及具有磁性的大型金屬物體均可能對遙控訊號及指南針產生干擾，進而威脅飛行安全。



≥10 公尺/秒

請勿在下雨、起大霧、下雪、打雷閃電、大風（風速每秒 10 公尺以上）等天氣下飛行。



請遠離旋轉中的螺旋槳，
否則可能會嚴重危及人身及財產安全。



禁航區

詳情請參閱以下網站：
<http://www.dji.com/flysafe>



了解禁飛區及飛行安全知識，對於您、周圍人群與環境的安全非常重要。
請務必詳讀《免責聲明與安全總覽》。

規格參數

• 航拍機	
起飛重量	909 g
最大水平飛行速度	每小時 72 公里 (運動模式, 海平面附近無風環境)
最大飛行海拔高度	6000 m
運作環境溫度	-10°C 至 40°C
GNSS	GPS+GLONASS
運作頻率	2.4-2.4835 GHz; 5.725-5.850 GHz
發射功率 (EIRP)	2.4 GHz FCC: ≤ 26 dBm; CE/MIC: ≤ 20 dBm; SRRC: ≤ 20 dBm
	5.8 GHz FCC: ≤ 26 dBm; CE: ≤ 14 dBm; SRRC: ≤ 26 dBm
機載儲存容量	24 GB
• 雲台	
可操控轉動範圍	俯仰: -90° 至 +30°
• 紅外線相機	
感應器	非製冷氧化釩微測輻射熱計
鏡頭焦距	約 9 mm 等效焦距: 約 38 mm
感測器解析度	640 × 512 @30Hz
數位變焦	16 ×
像素間距	12 μm
波長範圍	8-14 μm
照片格式	R-JPEG
影片格式	MP4
測溫方式	點測溫、區域測溫
FFC	自動 / 手動
• 可見光相機	
影像感測器	1/2 英寸 CMOS; 有效像素 4800 萬
鏡頭	視角: 約 84° 等效焦距: 24 mm 光圈: f/2.8 對焦點: 1 m 至無窮遠
ISO 範圍	影片: 100-12800 (自動) 照片: 100-1600 (自動)
最大照片尺寸	8000 × 6000
照片拍攝模式	單張拍攝 定時拍攝: 2/3/5/7/10/15/20/30/60 秒 全景: 球形拍攝
錄影解析度	3840 × 2160@30fps 1920 × 1080@30fps
圖片格式	JPEG
影片格式	MP4
• 遙控器	
運作頻率	2.400-2.483 GHz; 5.725-5.850 GHz
最大訊號有效距離 (無干擾、無遮蔽)	FCC: 10 公里; CE: 6 公里; SRRC: 6 公里; MIC: 6 公里

等效全向輻射功率(EIRP)	2.4 GHz FCC: ≤ 25.5 dBm; CE/MIC: ≤ 18.5 dBm; SRRC: ≤ 19 dBm 5.8 GHz FCC: ≤ 25.5 dBm; CE: ≤ 12.5 dBm; SRRC: ≤ 18.5 dBm
儲存空間	ROM 16 GB + microSD 可擴充儲存空間
電池	5000 mAh @ 7.2 V
運作環境溫度	-20°C 至 40°C
充電時間	2 小時 (使用規格為 12V/2A 的 USB 充電器)
續航時間	2.5 小時
24W USB 充電器	輸入: 100-240 V, 50-60 Hz, 最大 0.8 A 輸出: 3.6-8 V \approx 3.0 A/12 V \approx 2.0 A
• 智能飛行電池	
容量	3850 mAh
電壓	17.6 V (滿充電壓) 15.4 V (標準電壓)
電池類型	LiPo
能量	59.29 Wh
電池整體重量	約 297 g
充電環境溫度	5°C 至 40°C
加熱方式	手動加熱、自動加熱
加熱溫度	-20°C 至 6°C
加熱時間	500 s (最大)
加熱功率	55 W (最大)
• 智能飛行電池充電器	
輸入	100-240 V, 50-60 Hz, 1.8 A
輸出	主路: 17.6 V \approx 3.41 A 或 17.0 V \approx 3.53 A USB: 5 V \approx 2 A
額定功率	60 W



要了解產品詳細資訊，請造訪以下網址下載《使用者手冊》

www.dji.com/mavic-2-enterprice-advanced

※ 內容如有更新，恕不另行通知。

MAVIC 是大疆創新的商標。
Copyright © 2021 大疆創新 版權所有

Printed in China.

機体

DJI™ MAVIC™ 2 Enterprise Advanced は全方向性ビジョンシステムおよび赤外線検知システム*を備え、サーマルカメラとビジュアルカメラ搭載の高度安定化3軸ジンバルカメラを搭載しています。これにより赤外線画像と視覚画像を同時に撮影することが可能になります。DJIの障害物検知技術は複雑な飛行や写真撮影をサポートし、一方AirSenseによる周辺空域の認識を実施し、パスワード保護により機体へのアクセスやすべてのデータの安全性を確保します。Mavic 2 Enterprise Advancedは最大32倍のデジタルズームに対応し、超高解像度の滑らかなサーマルイメージセンサーと高画素ビジュアルセンサーを搭載しています。この機体の最大飛行速度は72 km/h、最大飛行時間**は31分です。

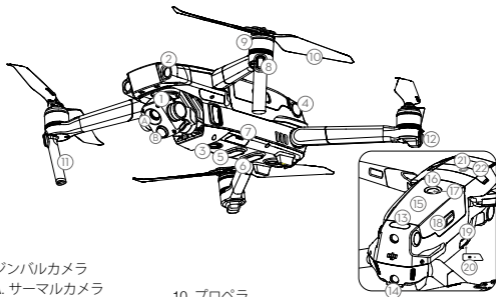

1. ジンバルカメラ

- A. サーマルカメラ
- B. ビジュアルカメラ
- 2. 前方ビジョンシステム
- 3. 下方ビジョンシステム
- 4. 側面ビジョンシステム
- 5. 下方赤外線検知システム
- 6. 底部補助ライト
- 7. microSD カード用スロット
- 8. フロント LED
- 9. モーター

- 10. プロペラ
- 11. アンテナ
- 12. 機体ステータスインジケータ
- 13. 上方赤外線検知システム
- 14. 後方ビジョンシステム
- 15. インテリジェント・フライト・バッテリー
- 16. バッテリー残量 LED
- 17. 電源ボタン

- 18. バッテリーバックル
- 19. USB-C ポート
- 20. リンクボタン/リンクステータスインジケータ
- 21. 拡張ポート (アクセサリ接続用)
- 22. 拡張ポートカバー

* ビジョンシステムおよび赤外線検知システムは、周辺環境の条件の影響を受けます。詳細に関しては、免責事項、安全に関するガイドライン、ユーザーマニュアルをお読みください。 <http://www.dji.com/mavic-2-enterprise-advanced>

** 最長飛行時間は無風状態で、定速 25km/h でテストしたものです。この値は参考値です。

DJI スマート送信機

DJI スマート送信機は、DJI の長距離伝送技術 OCUSSYNC™ 2.0 を搭載する送信機で、最大伝送距離は 10 km（日本国内では 6 km）で、機体カメラからの HD ライブビューを実現します。DJI スマート送信機は、5.5 インチ高輝度スクリーンを内蔵しています。また、カスタム可能なボタンを備え、様々な機体とジンバル制御を実現します。さらに、Bluetooth や GNSS といった多機能性も装備。Wi-Fi によるインターネット接続にも対応しています。DJI スマート送信機の最大動作時間は 2.5 時間です*。

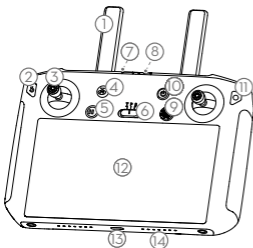

1. アンテナ
2. 戻るボタン／ファンクションボタン
3. スティック
4. RTH ボタン
5. フライト一時停止ボタン
6. フライトモードスイッチ
7. ステータス LED
8. バッテリー残量 LED
9. 5D ボタン
10. 電源ボタン
11. 確認ボタン／カスタムボタン C3
12. タッチスクリーン
13. USB-C ポート
14. マイク
15. ジンバルダイヤル



16. 録画ボタン
17. HDMI ポート
18. microSD カード用スロット
19. USB-A ポート
20. フォーカス／シャッターボタン
21. 絞り／シャッター調節ダイヤル

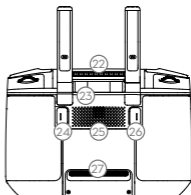

22. 通気口
23. スティック格納スロット
24. カスタムボタン C2
25. スピーカー
26. カスタムボタン C1
27. 吸気口

* DJI スマート送信機は、高度約 120m で広くて開けた電磁干渉のない場所で、最大伝送距離 (FCC) を実現します。最大稼働時間は、ラボ環境でテストされています。この値は参考値です。

1. 機体の準備



カメラからジンバルカバーを取り外します。



前方アームを展開します。



後方アームを展開します。



マークあり マークなし
プロペラをモーターに
合わせます。



カチッという音がして
固定されるまで、プロ
ペラを押し下げて回転
させます。



展開状態

 前方のアームとプロペラを展開してから、後方のアームとプロペラを展開します。
離陸前にすべてのアームとプロペラを展開しておく必要があります。

2. バッテリーの充電

初めて使用する場合は、付属の充電器を使用して、インテリジェント・フライト・バッテリーを完全に充電しておきます。

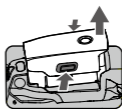

インテリジェント・フライト・
バッテリーの取り外し

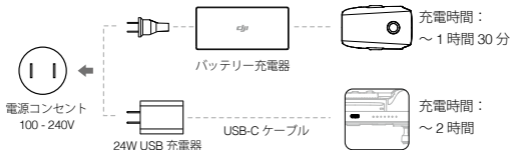

 DJI スマート送信機を充電する場合、24W USB 充電器（純正品）を使用してください。
標準の 24W USB 充電器がお手元がない場合、FCC/CE 認定の定格 12V/2A の USB 充電器のご使用を推奨します。

・バッテリー残量の確認と電源のオン/オフ

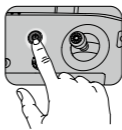
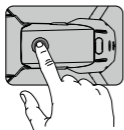

低 ←————→ 高



ボタンを1回押すと、バッテリー残量を
確認できます。

ボタンを押してから、次に長押しすると、
電源がオンまたはオフになります。

ボタンを1回押すと、液晶画面でバッテリ
ー残量を確認できます。

ボタンを1回押し、次に長押しすると、送
信機の電源がオンまたはオフになります。



バッテリーを機体に取り付け、電源を入れてください。バッテリー温度が6℃以下になると、自動発熱機能により温度を8～10℃に維持します。詳しくはユーザーマニュアルをご覧ください。

3. 送信機の準備



アンテナを持ち
上げる



スティック
を取り外す



回転させてス
ティック
を取り付ける



最適な伝送範囲は上図に示されています。アンテナが機体の方に向いていることを確認してください。アンテナとスマート送信機の背面との間の角度が80°または180°である場合、スマート送信機と機体との間の接続は最適な性能に到達できます。



- ・コントロールスティックをしっかりと取り付けてください。
- ・実際の操作では、DJI Pilot アプリは伝送信号が弱いことを警告します。機体が最適な伝送範囲に戻るようアンテナを調整してください。

4. 離陸の準備



送信機の電源を入れる



機体の電源を入れる



DJI Pilot を起動する



インターネット

DJI アカウントを使用して、機体と DJI スマート送信機をアクティベーションします。アクティベーションにはインターネット接続が必要です。DJI Pilot で機体をアクティベーションする前に、DJI スマート送信機の電源を入れ、指示に従ってアクティベーションしてください。



安全なアクセスと内蔵データの保護を確実にするため、DJI Pilot アプリで機体のパスワードを設定してください。

5. 飛行

離陸する前に、DJI Pilot の機体ステータスバーに「Ready to Go」が表示されていることを確認してください。

Ready to Go (GPS)

・手動での離陸/着陸

コンビネーション・スティック・コマンドでモーター始動/停止



または



左スティックを
ゆっくり上に倒
して離陸



地面に着くまで、左スティックを（ゆっくりと）下に倒します。
数秒間そのまま保持してから、モーターを停止します。



飛行中のモーター停止は、人体や物体への損傷・負傷のリスクを低減させる目的で緊急時のみ行ってください。モーターの停止方法は、DJI Pilot で設定することができます。

送信機操作

デフォルトのフライトコントロールはモード2です。左スティックで機体の高度と進行方向、右スティックで前進、後退、右回転、左回転をコントロールします。ジンバルダイヤルでカメラのチルト操作をコントロールします。

左スティック



右スティック

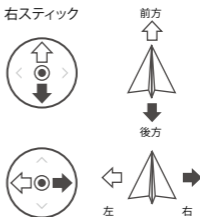

- 離陸前に、必ず適切な Return-to-Home (RTH) 高度を設定してください。機体をホームポイントに戻す際は、コントロールスティックで誘導してください。
- 飛行中に緊急ブレーキをかけるときは、フライト一時停止ボタンを押します。

* モジュラーアクセサリー



M2E ビーコン



M2E スポットライト



M2E スピーカー



M2EA RTK モジュール
(別売)

6. 安全なフライトのために



開けた場所での
飛行

+



強いGPS信号

+



視界の維持

+



120m未満の高度で
飛行



障害物、人混み、高電圧線、樹木、水域の近くで飛行させないでください。
電線や基地局などの強い電磁波域の周辺では、機体のコンパスが性能を発揮できないことがあるため、飛行させないでください。



雨、雪、霧、風速10m/s超などの悪天候時に機体を使用しないでください。



回転中のプロペラやモーターから
離れてください。



飛行禁止区域

詳細については、以下でご確認ください。
<http://www.dji.com/flysafe>



ご自身の安全と周りの人々の安全のため、基本的なフライトガイドラインを理解することが重要です。免責事項および安全に関するガイドラインを必ずお読みください。

仕様

•機体

離陸重量	909 g
最大速度	72 km/h (Sモード) (海拔 0m、無風)
運用限界高度 (海拔)	6000 m
動作環境温度範囲	-10 ~ 40° C
GNSS	GPS + GLONASS
動作周波数	2.4 ~ 2.4835 GHz、 5.725 ~ 5.850 GHz (日本では 2.4 ~ 2.4835 GHz のみ)
伝送電力 (EIRP)	2.4 GHz FCC : ≤ 26 dBm、CE/MIC (日本) : ≤ 20 dBm、SRRC : ≤ 20 dBm 5.8 GHz FCC : ≤ 26 dBm、CE : ≤ 14 dBm、SRRC : ≤ 26 dBm
内部ストレージ	24 GB

•ジンバル

操作可能範囲	チルト : -90° ~ +30°
--------	-------------------

•サーマルカメラ

センサー	非冷却 VOx マイクロボロメータ
レンズ焦点距離	約 9 mm 35 mm 判換算 : 約 38 mm
センサー解像度	640 × 512 @30 Hz
デジタルズーム	16 倍
画素ピッチ	12 μm
スペクトル帯	8-14 μm
静止画	R-JPEG
動画	MP4
温度測定方法	スポット測定、エリア測定
FFC	オート/マニュアル

•ビジュアルカメラ

センサー	1/2 インチ CMOS、有効画素 : 48 M
レンズ	FOV : 約 84° 35mm 判換算 : 24 mm 絞り : F2.8 フォーカス : 1 m ~ ∞
ISO 感度	動画 : 100 ~ 12800 (オート) 写真 : 100 ~ 1600 (オート)
最大静止画サイズ	8000 × 6000
静止画モード	シングルショット インターバル (2/3/5/7/10/15/20/30/60 秒) パノラマ : スフィアパノラマ
動画撮影モード	3840 × 2160@30fps 1920 × 1080@30fps
静止画	JPEG
動画	MP4

• スマート送信機

動作周波数	2.400 ~ 2.483 GHz、5.725 ~ 5.850 GHz (日本では 2.400 ~ 2.4835 GHz のみ)
最大伝送距離 (障害物や干渉がない場合)	FCC : 10 km、CE : 6 km、SRRC: 6 km、MIC (日本) : 6 km
伝送電力 (EIRP)	2.4 GHz FCC : ≤ 25.5 dBm、CE/MIC (日本) : ≤ 18.5 dBm、SRRC : ≤ 19 dBm 5.8 GHz FCC : ≤ 25.5 dBm、CE : ≤ 12.5 dBm、SRRC : ≤ 18.5 dBm
ストレージ容量	ROM 16 GB + 拡張性 (microSD カード)
バッテリー	5000 mAh @ 7.2 V
動作環境温度範囲	-20°C ~ 40°C
充電時間	2 時間 (12V/2A の USB 充電器使用時)
バッテリー寿命	2 時間 30 分
24 W USB 充電器	入力 : 100 ~ 240 V、50-60 Hz、最大電流 0.8 A 出力 : 3.6 ~ 8 V = 3.0 A / 12 V = 2.0 A

• インテリジェント フライトバッテリー

容量	3850 mAh
電圧	17.6V (最大) 15.4V (標準)
バッテリータイプ	LiPo
電力量	59.29 Wh
正味重量	約 297 g
充電温度範囲	5 ~ 40°C
発熱方法	マニュアル/オート
発熱温度範囲	-20° ~ 6°C
発熱時間	500 秒 (最大)
発熱電力	55 W (最大)

• インテリジェント フライトバッテリー充電器

入力	100 ~ 240 V、50-60 Hz、1.8 A
出力	メイン : 17.6V = 3.41 A または 17.0V = 3.53 A USB : 5 V = 2 A
定格出力	60 W

 詳細については、以下にあるユーザーマニュアルを参照してください。
www.dji.com/mavic-2-enterprice-advanced

※ このコンテンツは予告なく変更される場合があります。

MAVIC は DJI の商標です。

Copyright © 2021 DJI All Rights Reserved.

Printed in China.

기체

DJI™ MAVIC™ 2 Enterprise Advanced의 특징점은 전방향 비전 시스템 및 적외선 감지 시스템*이며, 완전히 안정화된 3축 짐벌에 열화상 카메라와 가시광선 카메라를 장착하여 적외선 및 가시광선 이미지 둘 모두를 동시에 제공합니다. DJI의 장애물 감지 기술이 적용된 AirSense는 사용자가 주위 환경을 인지하여 복잡한 환경에서 비행 및 촬영할 수 있도록 지원하며, 암호 보호 기능은 사용자가 기체의 모든 데이터에 대해 안전하게 액세스하도록 보장합니다. Mavic 2 Enterprise Advanced는 최대 32배의 디지털 줌을 지원하며 현저히 개선된 해상도로 더 부드러운 이미지를 제공하는 열화상 이미지 센서와 함께 더 높은 픽셀을 제공하는 가시광 센서를 갖추고 있습니다. 기체의 최대 비행 속도는 72km/h이며, 최대 비행시간**은 31분입니다.

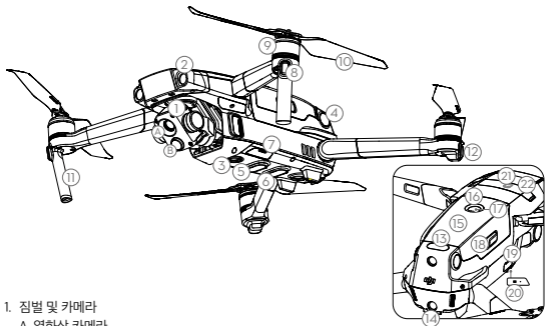

1. 짐벌 및 카메라

A. 열화상 카메라

B. 시각 카메라

2. 전방 비전 시스템

3. 하향 비전 시스템

4. 측방 비전 시스템

5. 하향 적외선 감지 시스템

6. 보조광

7. microSD 카드 슬롯

8. 전방 LED

9. 모터

10. 프로펠러

11. 안테나

12. 기체 상태 표시기

13. 상향 적외선 감지 시스템

14. 후방 비전 시스템

15. 인텔리전트 플라이트 배터리

16. 배터리 잔량 LED

17. 전원 버튼

18. 배터리 버클

19. USB-C 포트

20. 연동 버튼/연동 상태 표시기

21. 확장 포트(액세서리 연결용)

22. 확장 포트 커버

* 비전 시스템 및 적외선 감지 시스템은 주변 환경의 영향을 받습니다. 자세한 내용은 고지 사항 및 안전 가이드, 사용자 매뉴얼을 참조하십시오. <http://www.dji.com/mavic-2-enterprise-advanced>

** 최대 비행시간은 지속적인 25km/h(15.5mph)의 무풍 환경에서 테스트했습니다. 이 값은 참조용으로만 사용해야 합니다.

DJI 스마트 조종기

DJI 스마트 조종기는 DJI의 원거리 전송 기술인 OCUSSYNC™ 2.0으로 구축된 조종기로 10km의 최대 전송 거리를 갖추고 있으며 기체의 카메라로부터 실시간 HD 뷰를 제공합니다. 스마트 조종기에는 여러 기체 및 짐벌 제어 장치와 사용자 설정 버튼이 있으며 블루투스 및 GNSS와 같은 여러 기능을 갖춘 5.5인치 고휘도 스크린이 탑재되어 있습니다. Wi-Fi를 통한 인터넷 연결도 지원됩니다. 스마트 조종기의 최대 작동 시간은 2.5시간입니다*.

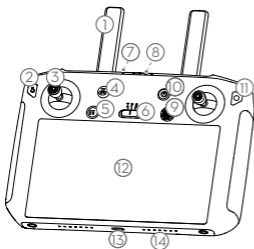

1. 안테나
2. 뒤로 버튼/기능 버튼
3. 스틱
4. RTH 버튼
5. 비행 일시 정지 버튼
6. 비행 모드 전환 스위치
7. 상태 LED
8. 배터리 잔량 LED
9. 5D 버튼
10. 전원 버튼
11. 확인 버튼/사용자 설정 버튼 C3
12. 터치 스크린
13. USB-C 포트
14. 마이크
15. 짐벌 다이얼



16. 녹화 버튼
17. HDMI 포트
18. MicroSD 카드 슬롯
19. USB-A 포트
20. 포커스/셔터 버튼
21. 조리개/셔터 조정 다이얼

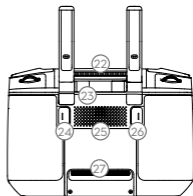

22. 통풍구
23. 스틱 보관 슬롯
24. 사용자 설정 버튼 C2
25. 스피커
26. 사용자 설정 버튼 C1
27. 흡기구

* 스마트 조종기는 트윈 야외 공간에서 자기장 간섭이 없을 때, 약 120m의 고도로 비행 시 최대 전송 거리(FCC)까지 제어가 가능합니다.
최대 지속 시간은 시험실 환경에서 테스트되었습니다. 이 값은 참조용으로만 사용해야 합니다.

1. 기체 준비

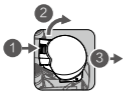

카메라에서 짐벌 커버를 분리합니다.



전방 암을 풉니다.



후방 암을 풉니다.

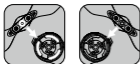

표시됨 표시되지 않음

모터에 프로펠러를 연결합니다.



프로펠러를 아래로 누르고 딸깍하며 제자리에 고정될 때까지 돌립니다.



편 상태

! 앞쪽 암과 프로펠러를 펴고 뒤쪽 암을 풉니다. 이륙 전에 모든 암과 프로펠러를 펴야 합니다.

2. 배터리 충전

처음 사용하기 전에 제공된 충전기를 사용하여 인텔리전트 플라이트 배터리를 완전히 충전합니다.

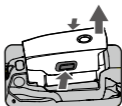

인텔리전트 플라이트 배터리 제거



전기 콘센트
100~240V



배터리 충전기



충전 시간:
1시간30분 미만



24W USB 충전기

USB-C 케이블



충전 시간:
2시간 미만



스마트 조종기를 충전하려면 공식 24W USB 충전기를 사용하십시오. 표준 24W USB 충전기를 사용할 수 없는 경우 FCC/CE 인증 12V/2A USB 충전기를 사용하는 것을 권장합니다.

•배터리 잔량 확인 및 전원 켜기/끄기

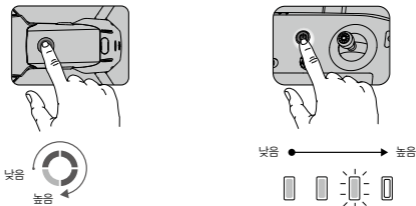

한 번 눌러 배터리 잔량을 확인합니다.
누른 다음 다시 길게 누르면 켜지거나 꺼집니다.

LCD 화면에서 한 번 눌러 배터리 수준을 확인합니다.

한 번 누른 다음 길게 누르면 조종기가 켜지거나 꺼집니다.

 기체에 배터리를 장착하고 전원을 켭니다. 배터리 온도가 6°C보다 낮아지면 자동으로 발열하여 8~10°C 사이의 온도를 유지합니다. 자세한 내용은 사용자 매뉴얼을 참조하십시오.

3. 조종기 준비



안테나를 들어 올리십시오



스틱을 분리하십시오



스틱을 돌려 부착하십시오

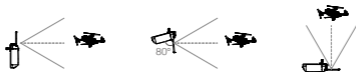

최적의 전송 범위는 위에 나와 있습니다. 안테나가 기체를 향하고 있는지 확인하십시오. 안테나와 스마트 조종기 후면의 각도가 80° 또는 180°인 경우 스마트 조종기와 기체 간의 연결이 최적의 성능에 도달할 수 있습니다.

-  • 조종 스틱이 단단히 장착되었는지 확인하십시오.
• 실제 작동 시, DJI Pilot 앱이 송신 신호가 약하다는 경고를 보내면 기체가 최적의 전송 범위로 돌아오도록 안테나를 조정하십시오.

4. 이륙 준비



조종기 전원을 켭니다.



기체의 전원을 켭니다.



DJI Pilot를 실행합니다.



인터넷

DJI 계정을 사용하여 기체 및 스마트 조종기를 활성화합니다. 활성화하려면 인터넷 연결이 필요합니다. DJI Pilot에서 기체를 활성화하기 전에 스마트 조종기의 전원을 켜고 지시사항에 따라 활성화합니다.



DJI Pilot 앱에서 기체 비밀번호를 설정하여 안전하게 액세스하고 내부 데이터를 보호하십시오.

5. 비행

이륙하기 전에 DJI Pilot의 기체 상태 표시줄에 'Ready to Go'가 표시되어 있는지 확인합니다.

Ready to Go(GPS)

• 수동 이륙/착륙

스틱 조합 명령어로 모터를 시동/중지합니다.



또는



왼쪽 스틱을 위로 움직여(느리게) 이륙합니다.



지면에 닿을 때까지 왼쪽 스틱을 천천히 아래로 내립니다. 몇 초 동안 유지하면 모터가 중지됩니다.



손상 또는 부상의 위험을 줄일 수 있도록 긴급 상황에서만 비행 중에 모터를 중지하십시오. DJI Pilot 앱에서 모터 중지 방법을 설정할 수 있습니다.

• 조종기 조작

기본 비행 제어 방법은 모드 2입니다. 왼쪽 스틱은 기체의 고도 및 방향을 제어하고 오른쪽 스틱은 전진, 후진, 왼쪽 또는 오른쪽 이동을 제어합니다. 짐벌 다이얼은 카메라의 틸트를 제어합니다.

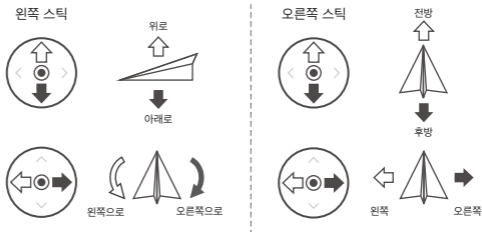

- 이륙하기 전에 항상 적절한 RTH 고도를 설정하십시오. 기체가 홈 포인트로 돌아올 때에는 조종 스틱으로 유도해야 합니다.
- 비행 도중 긴급 제동해야 할 경우 Flight Pause 버튼을 누르십시오.

* 모듈식 액세서리



M2E 비콘



M2E 스포트라이트



M2E 스피커



M2EA RTK 모듈
(별매)

7. 비행 안전



시야가 확보된 넓은
지역에서 비행



강력한 GPS
신호



시야 유지



120m(400피트) 고도
미만에서 비행

KR



장애물, 군중, 고압 전선, 나무 또는 수계 상공이나 근처에서 비행하지 마십시오.
전선 및 기지국에서 발생하는 강력한 전자기기는 내장 콤팩스에 영향을 줄 수 있으므로 이런
지역 근처에서 비행하지 마십시오.



10m/초 이상

비, 눈, 안개, 10m/초(22mph) 이상의 강풍이 부는 악천후에서는 기체를 사용하지
마십시오.



회전하는 프로펠러와 모터에서 멀리 떨어져
계십시오.



비행 금지 구역

자세한 정보:

<http://www.dji.com/flysafe>



본인과 주변의 안전을 위해 기본 비행 지침을 반드시 숙지해야 합니다. 고지 사항 및 안전 가이드를
잊지 말고 읽어보십시오.

사양

• 기체	
이륙 무게	909 g
최대 속도	72 km/h (S 모드) (해수면 근처, 무풍 시)
최대 실용 상승 한계 고도 (해발)	6000 m
작동 온도 범위	-10~40 °C
GNSS	GPS+GLONASS
작동 주파수	2.4~2.4835 GHz, 5.725~5.850 GHz
전송 출력 (EIRP)	2.4 GHz FCC: ≤26 dBm, CE/MIC: ≤20 dBm, SRRC: ≤20 dBm 5.8 GHz FCC: ≤26 dBm, CE: ≤14 dBm, SRRC: ≤26 dBm
내부 저장 장치	24 GB
• 짐벌	
제어 가능 범위	틸트: -90° ~ 30°
• 열화상 카메라	
센서	비냉각식 산화바나듐(VoX) 마이크로볼로미터
렌즈 초점 거리	약 9 mm 35 mm 환산: 약 38 mm
센서 해상도	640×512@30Hz
디지털 줌	16배
픽셀 피치	12 μm
스펙트럼 범위	8~14 μm
사진	R-JPEG
동영상	MP4
온도 측정 방식	스팟 미터, 지역 측정
FFC	자동/수동
• 가시광 카메라	
센서	1/2" CMOS, 유효 픽셀: 48 MP
렌즈	FOV: 약 84° 35 mm 환산: 24 mm 조리개: f/2.8 포커스: 1 m ~ ∞
ISO 범위	동영상: 100~12800 (자동) 사진: 100~1600 (자동)
최대 이미지 크기	8000×6000
스틸 사진 모드	단일 촬영 인터벌: 2/3/5/7/10/15/20/30/60 초 파노라마: Sphere
동영상 촬영 모드	3840×2160@30fps 1920×1080@30fps
사진	JPEG
동영상	MP4

<ul style="list-style-type: none"> 스마트 조종기 	
작동 주파수	2.400~2.483 GHz, 5.725~5.850 GHz
최대 전송 거리 (장애물과 간섭이 없을 시)	FCC: 10 km, CE: 6 km, SRRC: 6 km, MIC: 6 km
송신기 출력 (EIRP)	2.4 GHz FCC: ≤25.5 dBm, CE/MIC: ≤18.5 dBm, SRRC: ≤19 dBm 5.8 GHz FCC: ≤25.5 dBm, CE: ≤12.5 dBm, SRRC: ≤18.5 dBm
저장 장치 용량	ROM 16 GB + microSD 외장 저장 장치
배터리	5000 mAh @7.2 V
작동 온도 범위	-20~40 °C
충전 시간	2시간 (12 V/2 A에서 USB 충전기)
배터리 사용 시간	2.5시간
24W USB 충전기	입력: 100~240 V, 50~60 Hz, 최대 0.8 A 출력: 3.6~8 V ≡ 3.0 A/12 V ≡ 2.0 A

- 인텔리전트 플라이트 배터리

용량	3850 mAh
전압	17.6 V (최대) 15.4 V (일반)
배터리 유형	LiPo
에너지	59.29 Wh
순 무게	약 297 g
충전 온도 범위	5~40 °C
발열 방식	수동/자동
발열 온도 범위	-20~6 °C
발열 시간	500초 (최대)
발열 전력	55 W (최대)

- 인텔리전트 플라이트 배터리 충전기

입력	100~240 V, 50~60 Hz, 1.8 A
출력	메인 포트: 17.6 V ≡ 3.41 A 또는 17.0 V ≡ 3.53 A USB: 5 V ≡ 2 A
정격 출력	60 W



자세한 내용은 사용자 매뉴얼을 확인하십시오.

www.dji.com/mavic-2-enterprice-advanced

※ 본 내용은 사전 고지 없이 변경될 수 있습니다.

MAVIC은 DJI의 상표입니다.
Copyright © 2021 DJI All Rights Reserved.

Printed in China.

Fluggerät

Die DJI™ MAVIC™ 2 Enterprise Advanced ist mit Sicht- und Infrarotsensoren zur omnidirektionalen Hinderniserkennung* ausgestattet. Zudem verfügt sie über einen auf drei Achsen voll stabilisierten Gimbal. Dank integrierter Sicht- und Wärmebildkamera, können gleichzeitig langwellige unsichtbare Infrarotstrahlung und Bilder im sichtbaren Spektralbereich dargestellt werden. Die Technologie zur Erkennung von Hindernissen von DJI unterstützt Anwender beim Fliegen und dem gleichzeitigen Erfassen von komplizierten Aufnahmen, während der nähere Luftraum mithilfe von AirSense bewusst wahrgenommen wird. Der Passwortschutz gewährleistet den Zugang zum Fluggerät und die Sicherheit aller Daten. Die Mavic 2 Enterprise Advanced unterstützt einen bis zu 32-fachen Digitalzoom und ist mit einem deutlich verbesserten Wärmebildsensor ausgestattet. Sowohl der Wärmebildsensor als auch der RGB-Sichtsensor weisen eine weitaus höhere Auflösung im Vergleich zum Vorgängermodell auf. Das Fluggerät besticht durch eine Höchstgeschwindigkeit von 72 km/h und eine maximale Flugzeit** von 31 Minuten.

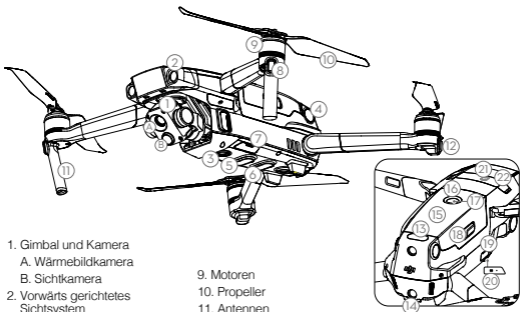

1. Gimbal und Kamera

- A. Wärmebildkamera
- B. Sichtkamera

2. Vorwärts gerichtetes Sichtsystem

3. Abwärts gerichtetes Sichtsystem

4. Seitliches Sichtsystem

5. Nach unten gerichtetes Infrarotsensorsystem

6. Hilfsbeleuchtung

7. Einschub für die Micro-SD-Karte

8. Vordere LEDs

9. Motoren

10. Propeller

11. Antennen

12. Statusanzeige des Fluggeräts

13. Nach oben gerichtete Infraroterkennung

14. Rückwärts gerichtetes Sichtsystem

15. Intelligent Flight Battery

16. Akkuladezustands-LED

17. Ein/Aus-Taste

18. Batterieklammern

19. USB-C-Anschluss

20. Koppeltaste/Kopplungsstatus-LED

21. Erweiterungssteckplatz (Zur Anbindung von Zubehör)

22. Abdeckung des Erweiterungssteckplatzes

* Die Sicht- und Infrarotsensorsysteme reagieren empfindlich auf die Umgebungsbedingungen. Lesen Sie den Haftungsausschluss und die Sicherheitsvorschriften sowie das Benutzerhandbuch, um mehr zu erfahren. <http://www.dji.com/mavic-2-enterprise-advanced>

** Die maximale Flugzeit wurde ohne Wind und bei einer konstanten Geschwindigkeit von 25 km/h getestet. Dieser Wert dient nur als Referenz.

DJI Smart-Fernsteuerung

Die DJI Smart-Fernsteuerung ist mit der Übertragungstechnologie OCUSYNC™ 2.0 ausgestattet, diese ermöglicht eine maximale Reichweite von 10 Kilometern und eine HD-Liveübertragung von der Hauptkamera. Sie bietet eine Vielzahl an Steuerungsmöglichkeiten für das Fluggerät und den Gimbal, mehrere frei belegbare Tasten, einen besonders hellen Bildschirm wie auch weitere Funktionalitäten wie Bluetooth oder GNSS. Die Verbindung zum Internet kann über Wi-Fi hergestellt werden. Die maximale Betriebszeit liegt bei 2.5 Stunden*.

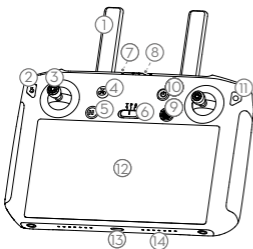

- 16. Videoaufnahme-taste
- 17. HDMI-Anschluss
- 18. Einschub für die Micro-SD-Karte
- 19. USB-A-Anschluss
- 20. Fokus-/Fototaste
- 21. Einstellrädchen für Blende/Verschlusszeit

- 1. Antennen
- 2. Zurück-Taste / Funktionstaste
- 3. Steuerknüppel
- 4. Rückkehrtaste
- 5. Taste zum Pausieren des Fluges
- 6. Flugmodus-schalter
- 7. Status-LED
- 8. Akkuladestatus-LED
- 9. 5D-Taste
- 10. Ein/Aus-Taste
- 11. Bestätigen-Taste / Anpassbare Taste C3
- 12. Touchscreen
- 13. USB-C-Anschluss
- 14. Mikrofon
- 15. Gimbalrädchen

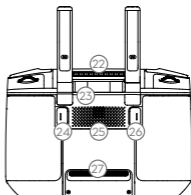

- 22. Entlüftungsschlitze
- 23. Aufbewahrungsfach für Steuerknüppel
- 24. Taste C2 (frei belegbar)
- 25. Lautsprecher
- 26. Taste C1 (frei belegbar)
- 27. Lufteinlass

* Die Smart-Fernsteuerung erreicht ihre maximale Übertragungsdistanz (FCC konform) in einer Höhe von etwa 120 m (offenes Gelände, ohne elektromagnetische Interferenzen).

Die maximale Laufzeit wurde unter Laborbedingungen getestet. Dieser Wert dient nur als Referenz.

1. Fluggerät vorbereiten

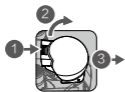

Entfernen Sie die Gimbal-Abdeckung von der Kamera.



Klappen Sie die vorderen Arme aus.



Klappen Sie die hinteren Arme aus.



Ordnen Sie die Propeller den richtigen Motoren zu.



Drücken Sie die Propeller nach unten und drehen Sie solange, bis diese einrasten.



Ausgeklappt



Klappen Sie die vorderen Arme und die Propeller aus, bevor Sie die hinteren Arme ausklappen. Vor dem Losfliegen müssen alle Arme und Propeller ausgeklappt sein.

2. Die Akkus laden

Verwenden Sie das im Lieferumfang enthaltene Ladegerät, um die Intelligent Flight Battery vor der ersten Verwendung vollständig aufzuladen.

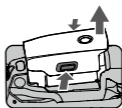

Intelligent Flight Battery entnehmen.

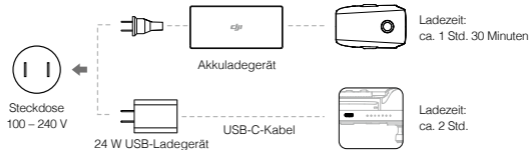

Bitte Nutzen Sie zum Laden der Smart-Fernsteuerung das offizielle 24W USB-Ladegerät. Sollte das offizielle 24W USB-Ladegerät nicht verfügbar sein, empfehlen wir Ihnen ein CE-zertifiziertes USB-Ladegerät mit 12V/2A.

* Ladezustand prüfen und Ein/Ausschalten

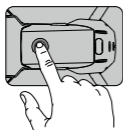

Drücken Sie die Taste einmal, um den Akku-Ladezustand zu überprüfen.

Drücken Sie die Taste einmal kurz und dann lang, um das Gerät ein-/auszuschalten.

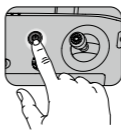

Niedrig Hoch



Drücken Sie die Taste einmal, um den Akkuladezustand auf dem LCD-Display zu überprüfen.

Drücken Sie die Taste noch einmal, und halten Sie sie gedrückt, um die Fernsteuerung ein-/auszuschalten.



Legen Sie den Akku in die Drohne und schalten Sie diese ein. Kühlt sich der Akku auf weniger als 6°C ab, erwärmt sich dieser automatisch, um seine Temperatur zwischen 8 und 10 °C zu halten. Für weitere Details schauen Sie bitte in der Bedienungsanleitung nach.

3. Fernsteuerung vorbereiten



Klappen Sie die Antennen aus



Entnehmen Sie die Steuerknüppel



Drehen Sie die Knüppel in die Fernsteuerung

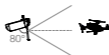

Der optimale Übertragungsbereich ist oben gezeigt. Stellen Sie sicher, dass die Antennenflächen auf das Fluggerät ausgerichtet sind. Wenn der Winkel zwischen den Antennen und der Rückseite der Smart-Fernsteuerung 80° oder 180° beträgt, kann die Verbindung zwischen der Smart-Fernsteuerung und dem Fluggerät ihre optimale Leistung erbringen.



- Stellen Sie sicher, dass die Steuerknüppel fest montiert sind.
- Im realen Betrieb wird die DJI Pilot App eine Warnung ausgeben, dass das Übertragungssignal schwach ist. Richten Sie dann die Antennen so aus, dass das Fluggerät wieder im optimalen Übertragungsbereich ist.

4. Vorbereitung für den Start



Fernsteuerung einschalten



Fluggerät einschalten



DJI Pilot starten



Internet

Verwenden Sie ein DJI Benutzerkonto zur Aktivierung des Fluggeräts und der Smart-Fernsteuerung. Die Aktivierung setzt eine Internetverbindung voraus. Schalten Sie vor der Aktivierung des Fluggeräts in DJI Pilot die Smart-Fernsteuerung ein und folgen Sie den Anweisungen zur Aktivierung.



Legen Sie in der DJI Pilot App bitte ein Passwort für die Drohne fest und sichern somit den Zugriff auf den internen Speicher ab.

5. Flug

Vergewissern Sie sich vor dem Losfliegen, dass die Statusleiste in DJI Pilot „Bereit“ anzeigt.

Ready to Go (GPS)

* Automatisches Starten/Landen

Knüppelkombination zum Ein-/
Ausschalten der Motoren



Linken Knüppel langsam
nach oben bewegen,
um zu starten



Drücken Sie den linken Knüppel nach unten
(langsam), bis das Fluggerät den Boden berührt.
Einige Sekunden halten, um die Motoren
auszuschalten



Schalten Sie die Motoren während des Fluges nur ab, WENN dadurch in einem Notfall Verletzungen oder Schäden vermieden werden können. Die Methode zum Stoppen der Motoren kann in DJI Pilot eingestellt werden.

* Die Fernsteuerung verwenden

Die Standard-Flugsteuerung wird als Modus 2 bezeichnet. Mit dem linken Steuerknüppel steuern Sie die Höhe und Flugrichtung des Fluggeräts, und mit dem rechten Steuerknüppel steuern Sie ihre Vorwärts-, Rückwärts-, Links- oder Rechtsbewegung. Mit dem Gimbal-Rädchen wird die Neigung der Kamera verstellt.

Linker Knüppel



Steigflug



Sinkflug



Linksdrehung

Rechtsdrehung

Rechter Knüppel



Vorwärts



Rückwärts



Links

Rechts



- Stellen Sie vor jedem Start immer eine geeignete Höhe für die Rückkehrfunktion ein. Wenn das Fluggerät zum Startpunkt zurückkehrt, sollten Sie es mit den Steuerknüppeln korrigieren, falls nötig.
- Drücken Sie die Taste „Flugpausentaste“ zur Notbremsung während des Fluges.

* Modulares Zubehör



M2E Kollisionswarnlicht



M2E Scheinwerfer



M2E Lautsprecher



M2EA RTK-Modul
(nicht im Lieferumfang enthalten)

6. Sicher fliegen



Nur in offenen
Bereichen fliegen

+



Starkes
GPS-Signal

+



Sichtkontakt
behalten

+



Fliegen Sie unterhalb
von 120 m.



Über- und umfliegen Sie Hindernisse, Menschenmengen, Hochspannungsleitungen, Bäume und Gewässer stets mit ausreichendem Sicherheitsabstand.

Fliegen Sie NICHT in die Nähe elektromagnetischer Quellen (z. B. Hochspannungsleitungen, Basisstationen), da die Funktion des Bordkompasses dadurch gestört werden kann.



Fliegen Sie NICHT bei widrigem Wetter (z. B. Regen, Schnee, Nebel oder Windgeschwindigkeiten über 10 m/s).



Halten Sie ausreichend Abstand zu den
drehenden Propellern und Motoren.



Flugverbotszonen
(GEO-Zone)

Mehr Informationen:
<http://www.dji.com/flysafe>



Um Ihre eigene Sicherheit und die Sicherheit der Menschen in Ihrer Umgebung zu gewährleisten, ist es wichtig, dass Sie die nötigen Grundregeln kennen. Lesen Sie sich den **Haftungsausschluss und die Sicherheitsvorschriften** durch..

Technische Daten

• Fluggerät

Startgewicht	909 g
Höchstgeschwindigkeit	72 km/h (S-Modus, auf Höhe des Meeresspiegels, bei Windstille)
Max. Flughöhe über dem Meeresspiegel	6.000 m
Betriebstemperatur	-10 °C bis +40 °C
GNSS	GPS + GLONASS
Betriebsfrequenz	2,4 – 2,4835 GHz; 5,725 – 5,850 GHz
Strahlungsleistung (EIRP)	2,4 GHz FCC: ≤26 dBm; CE/MIC: ≤20 dBm; SRRC: ≤20 dBm 5,8 GHz FCC: ≤26 dBm; CE: ≤14 dBm; SRRC: ≤26 dBm
Interner Speicher	24 GB

• Gimbal

Steuerbarer Bereich	Neigen: -90° bis 30°
---------------------	----------------------

• Wärmebildkamera

Sensor	Ungekühltes VOx-Mikrobolometer
Brennweite des Objektivs	Ca. 9 mm Äquivalent: Ca. 38 mm
Sensorauflösung	640 × 512 mit 30 Hz
Digitalzoom	16×
Pixelabstand	12 µm
Spektralband	8 – 14 µm
Foto	R-JPEG
Video	MP4
Temperaturmessmethode	Punktmessung, Bereichsmessung
FFC	Autom./Manuell

• Sichtkamera

Sensor	1/2-Zoll-CMOS, effektive Pixel: 48 MP
Objektiv	Sichtfeld (FOV): ca. 84° Äquivalent: 24 mm Blende: f/2.8 Fokus: 1 m bis ∞
ISO-Bereich	Video: 100 – 12800 (automatisch) Foto: 100 – 1600 (automatisch)
Maximale Auflösung	8.000 × 6.000
Fotomodi	Einzelaufnahme Intervall (2/3/5/7/10/15/20/30/60 s) Panorama: sphärisches Panorama
Videomodi	3840 × 2160 mit 30 fps 1920 × 1080 mit 30 fps
Foto	JPEG
Video	MP4

• Smart-Fernsteuerung

Betriebsfrequenz	2,400 – 2,483 GHz; 5,725 – 5,850 GHz
Max. Übertragungsreichweite (ohne Hindernisse, störungsfrei)	FCC: 10 km; CE: 6 km; SRRC: 6 km; MIC: 6 km
Strahlungsleistung (EIRP)	2,4 GHz FCC: $\leq 25,5$ dBm; CE/MIC: $\leq 18,5$ dBm; SRRC: ≤ 19 dBm 5,8 GHz FCC: $\leq 25,5$ dBm; CE: $\leq 12,5$ dBm; SRRC: $\leq 18,5$ dBm
Speicherkapazität	ROM 16 GB + skalierbar mit microSD-Karte
Akku	5.000 mAh mit 7,2 V
Betriebstemperatur	-20 °C bis 40 °C
Ladezeit	2 Stunden (mit einem USB-Ladegerät bei 12 V / 2 A)
Akkulaufzeit	2,5 Stunden
USB-Ladegerät, 24 W	Eingang: Max. 100 – 240 V, 50 – 60 Hz 0,8 A Ausgang: 3,6 – 8 V \approx 3,0 A / 12 V \approx 2,0 A

• Intelligent Flight Battery

Speicherkapazität	3.850 mAh
Spannung	17,6 V (max.) 15,4 V (normal)
Akkutyp	LiPo
Energie	59,29 Wh
Eigengewicht	Ca. 297 g
Ladetemperaturbereich	5 °C bis 40 °C
Erwärmungsmethode	Autom./Manuell
Erwärmungstemperaturbereich	-20 °C bis 6 °C
Erwärmungszeit	500 s (max.)
Wärmeleistung	55 W (max.)

• Ladegerät für Intelligent Flight Battery

Eingang	100 – 240 V, 50 – 60 Hz, 1,8 A
Ausgang	Hauptausgang: 17,6 V \approx 3,41 A oder 17,0 V \approx 3,53 A USB: 5 V \approx 2 A
Nennleistung	60 W



Nähere Informationen finden Sie in der Bedienungsanleitung:
www.dji.com/mavic-2-enterprice-advanced

※ Der Inhalt kann jederzeit unangekündigt geändert werden.

MAVIC is a trademark of DJI.
Copyright © 2021 DJI All Rights Reserved.

Gedruckt in China.

Aeronave

El Mavic™ 2 Enterprise Advanced de DJI™ cuenta con sistemas de visión omnidireccional y sistemas de detección por infrarrojos*. Además, incluye una cámara con estabilizador en tres ejes totalmente estabilizada con una cámara térmica y una cámara visual, para proporcionar imágenes tanto infrarrojas como visuales simultáneamente. La tecnología de detección de obstáculos de DJI ayuda a los usuarios a volar y capturar tomas complejas, mientras que AirSense proporciona información sobre el espacio aéreo circundante. Además, la protección con contraseña garantiza que el acceso a la aeronave y todos los datos sean seguros. El Mavic 2 Enterprise Advanced admite un zoom digital de hasta 32x y tiene un sensor de imagen térmica más fluido con una resolución significativamente más alta, así como un sensor visual de píxeles más alto. La aeronave alcanza una velocidad máxima de vuelo de 72 km/h (44,7 mph) y cuenta con un tiempo máximo de vuelo** de 31 minutos.

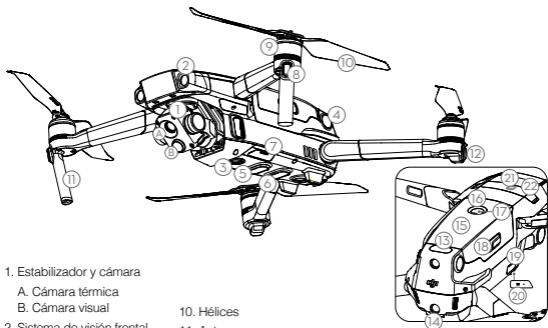

1. Estabilizador y cámara

- A. Cámara térmica
- B. Cámara visual

2. Sistema de visión frontal

3. Sistema de visión inferior

4. Sistema de visión lateral

5. Sistema de detección inferior por infrarrojos

6. Luz inferior auxiliar

7. Ranura para tarjeta microSD

8. Indicadores LED delanteros

9. Motores

10. Hélices

11. Antenas

12. Indicador de estado de la aeronave

13. Sistema de detección superior por infrarrojos

14. Sistema de visión de retroceso

15. Batería de Vuelo Inteligente

16. Indicadores LED de nivel de batería

17. Botón de encendido

18. Bandas de sujeción de la batería

19. Puerto USB-C

20. Botón de vinculación/ indicador de estado de vinculación

21. Puerto de accesorios

22. Tapa del puerto de accesorios

* El sistema de visión y el sistema de detección por infrarrojos se ven afectados por las condiciones del entorno. Para obtener más información, lea la Renuncia de responsabilidad y directrices de seguridad y el Manual de usuario. <http://www.dji.com/mavic-2-enterprise-advanced>

** El tiempo máximo de vuelo se determinó en un entorno sin viento a una velocidad sostenida de 25 km/h (15,5 mph). Este valor se proporciona sólo como referencia.

DJI Smart Controller

El DJI Smart Controller es un control remoto que incorpora OCUSYNC™ 2.0, la tecnología de transmisión de largo alcance de DJI, gracias al cual permite tener una visión en HD de lo que ve la cámara de la aeronave a una distancia de 10 km (6.2 millas). El Smart Controller incluye controles para varias aeronaves y cámaras, además de botones configurables. Tiene también una pantalla de 5.5 pulgadas y de alto brillo con funciones como Bluetooth y GNSS. Puede conectarse a Internet mediante Wi-Fi. El Smart Controller tiene un tiempo máximo de funcionamiento de 2.5 horas*.

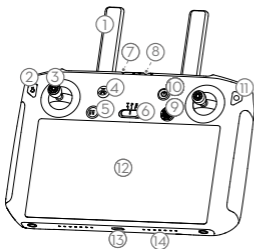

1. Antenas
2. Botón atrás y funciones
3. Palancas
4. Botón RTH
5. Botón de detener vuelo
6. Selector de modo de vuelo
7. Indicador LED de estado
8. Indicadores LED del nivel de la batería
9. Botón 5D
10. Botón de encendido
11. Botón de confirmación y botón C3 personalizable
12. Pantalla táctil
13. Puerto USB-C
14. Micrófono
15. Dial del estabilizador



16. Botón de grabación
17. Puerto HDMI
18. Ranura para tarjeta microSD
19. Puerto USB-A
20. Botón del obturador y enfoque
21. Dial de ajuste de la apertura / del obturador

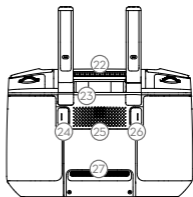

22. Salida de aire
23. Ranura de almacenamiento de palancas
24. Botón C2 personalizable
25. Altavoz
26. Botón C1 personalizable
27. Entrada de aire

* El Smart Controller alcanza su distancia máxima de transmisión (siguiendo las normas de la FCC) en un área abierta y amplia sin interferencias electromagnéticas y a una altitud de unos 120 metros (400 pies). El tiempo de funcionamiento máximo se ha probado en un entorno de laboratorio. Este valor se proporciona sólo como referencia.

2. Preparación de la aeronave

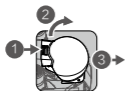

Retire la cubierta del estabilizador de la cámara.



Despliegue los brazos delanteros.



Despliegue los brazos traseros.



Con marca

Sin marca

Empareje las hélices con los motores.



Presione las hélices hacia abajo y gírelas hasta que encajen en su lugar.



Desplegado



Despliegue los brazos y hélices frontales antes que los posteriores. Todos los brazos y hélices deben estar desplegados antes del despegue.

3. Carga de las baterías

Utilice el cargador suministrado para cargar completamente la Batería de Vuelo Inteligente antes del primer uso.

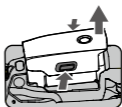

Extraiga la Batería de Vuelo Inteligente



Toma de alimentación
100 - 240 V



Cargador de batería



Tiempo de carga:
~1 hora y 30 minutos



Cargador USB 24 W

Cable USB-C



Tiempo de carga:
~2 horas



Por favor utilice el cargador USB oficial de 24 W para cargar el Smart Controller. Si no dispone de un cargador USB estándar de 24 W, se recomienda utilizar un cargador USB con certificación FCC/CE con una potencia nominal de 12 V/2 A

• Comprobar los niveles de batería y encendido/apagado

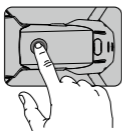

Pulse una vez para comprobar el nivel de batería.

Pulse una vez, después otra y mantenga pulsado para encender o apagar.

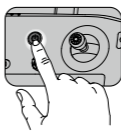

Bajo  Alto



Pulse una vez para comprobar el nivel de batería en la pantalla LCD.

Pulse una vez, después otra y mantenga pulsado para encender o apagar el control remoto.



Instale la batería en la aeronave y enciéndala. Si la temperatura de la batería desciende por debajo de 6 °C, se autocalentará para mantener una temperatura de entre 8 y 10 °C. Consulte el Manual de usuario para más detalles.

4. Preparación del controlador remoto



Levante las antenas



Retire las palancas



Gire para unir las palancas



El intervalo de transmisión óptimo se muestra arriba. Asegúrese de que las antenas estén orientadas hacia la aeronave. Cuando el ángulo entre las antenas y la parte posterior del Control Remoto Inteligente sea de 80° o 180°, la conexión entre el Control Remoto Inteligente y la aeronave podrá alcanzar su rendimiento óptimo.



- Compruebe que las palancas de control estén bien montadas.
- Durante el funcionamiento real, la aplicación DJI Pilot le mostrará una advertencia cuando la señal de transmisión sea débil. En ese caso, ajuste las antenas para asegurarse de que la aeronave vuelva al intervalo de transmisión óptimo.

5. Preparación para el despegue



Encienda el controlador remoto.



Encienda la aeronave.



Inicie DJI Pilot.



Utiliza una cuenta DJI para activar la aeronave y el Smart Controller. Se requiere una conexión a Internet para la activación. Antes de activar la aeronave en DJI Pilot, encienda el Smart Controller y siga las indicaciones para activarlo.



Establezca una contraseña para la aeronave con la aplicación DJI Pilot para garantizar la seguridad de los datos de a bordo.

6. Vuelo

Antes de despegar, asegúrese de que la barra de estado de la aeronave en la aplicación DJI Pilot muestre "Ready to Go".

Ready to Go (GPS)

* Despegue/aterrizaje manuales

Comando de combinación de palancas para arrancar/detener los motores



O bien



Palanca izquierda arriba (espacio) para despegar



Palanca izquierda abajo (espacio) hasta tocar suelo
Mantenga unos segundos para detener los motores



Para reducir el riesgo de daños o lesiones, detenga los motores en pleno vuelo solo en situaciones de emergencia. El método para detener los motores puede configurarse en DJI Pilot.

* Funcionamiento del control remoto

El control de vuelo predeterminado se conoce como Modo 2. La palanca izquierda controla la altitud y la dirección de la aeronave, mientras que la derecha controla los movimientos hacia delante, atrás, izquierda y derecha. El selector del estabilizador controla la inclinación de la cámara.

Palanca izquierda



Palanca derecha



- Establezca siempre una altitud de RTH (Regreso al punto de origen) adecuada antes del despegue. Cuando la aeronave esté volviendo al punto de origen, debe guiarla con las palancas de control.
- Pulse el botón de pausa de vuelo para una frenada de emergencia durante el vuelo.

* Módulos accesorios



Baliza M2E



Foco M2E



Altavoz M2E



Módulo RTK M2EA
(no incluida)

7. Vuele seguro



Vuele en espacios abiertos

+



Señal fuerte de GPS

+



Mantenga una línea de visión directa

+



Vuele por debajo de 120 m (400 pies)



Evite volar por encima o cerca de obstáculos, multitudes, líneas de alta tensión, árboles o masas de agua.

NO vuele cerca de fuentes electromagnéticas, como tendidos eléctricos y estaciones base, ya que puede afectar a la brújula de a bordo.



NO utilice la aeronave en condiciones climáticas adversas como lluvia, nieve, niebla ni con una velocidad del viento superior a 10 m/s o 22 mph.



Manténgase alejado de las hélices y los motores en rotación.



Zona GEO

Obtenga más información en:
<http://www.dji.com/flysafe>



Es importante conocer las directrices básicas de vuelo para su propia seguridad y la de quienes le rodean. No olvide leer la **Renuncia de responsabilidad y las directrices de seguridad**.

Especificaciones

• Aeronave

Peso de despegue	909 g
Velocidad máx.	72 km/h (modo S) (cerca del nivel del mar, sin viento)
Altitud máx. de vuelo	6000 m
Rango de temperatura de funcionamiento	De -10 a 40 °C (de 14 a 104 °F)
GNSS	GPS+GLONASS
Frecuencia de funcionamiento	2.4-2.4835 GHz; 5.725-5.850 GHz
Transmisión de potencia (PIRE)	2.4 GHz FCC: ≤26 dBm; CE/MIC: ≤20 dBm; SRRC: ≤20 dBm 5.8 GHz FCC: ≤26 dBm; CE: ≤14 dBm; SRRC: ≤26 dBm
Almacenamiento interno	24 GB

• Estabilizador

Intervalo controlable	Inclinación: de -90° a 30°
-----------------------	----------------------------

• Cámara térmica

Sensor	Microbolómetro VOx no refrigerado
Distancia focal del objetivo	Aprox. 9 mm Equivalente: Aprox. 38 mm
Resolución del sensor	640×512 a 30 Hz
Zoom digital	16x
Distancia entre píxeles	12 μm
Banda espectral	8-14 μm
Foto	R-JPEG
Vídeo	MP4
Método de medición de temperatura	Medidor puntual, medición de área
FFC	Auto/Manual

• Cámara visual

Sensor	CMOS de 1/2", píxeles efectivos: 48 M
Objetivo	Campo de visión: aprox. 84° Formato equivalente: 24 mm Apertura: f/2.8 Enfoque: 1 m a ∞
Rango ISO	Vídeo: 100-12800 (auto) Fotografía: 100-1600 (automático)
Tamaño de imagen máx.	8000 × 6000
Modos de fotografía	Disparo único Intervalo (2/3/5/7/10/15/20/30/60 s) Pano: panorámica esférica
Modos de grabación de vídeo	3840×2160 a 30 fps 1920×1080 a 30 fps
Foto	JPEG

Vídeo	MP4
• Smart Controller	
Frecuencia de funcionamiento	2.400-2.483 GHz; 5.725-5.850 GHz
Alcance de transmisión máx. (sin obstáculos, libre de interferencias)	FCC: 10 km; CE: 6 km; SRRC: 6 km; MIC: 6 km
Potencia del transmisor (PIRE)	2.4 GHz FCC: ≤25,5 dBm; CE/MIC: ≤18,5 dBm; SRRC: ≤19 dBm 5.8 GHz FCC: ≤25.5 dBm; CE: ≤12.5 dBm; SRRC: ≤18.5 dBm
Capacidad de almacenamiento	ROM 16 GB + escalable (tarjeta microSD)
Batería	5000 mAh a 7.2 V
Rango de temperatura de funcionamiento	de -20 a 40 °C (de -4 a 104 °F)
Tiempo de carga	2 h (con un cargador USB a 12 V/2 A)
Vida de la batería	2.5 h
Cargador USB 24 W	Entrada: 100-240 V, 50/60 Hz, Máx. 0.8 A Salida: 3.6-8 V = 3.0 A/12 V = 2.0 A
• Batería de Vuelo Inteligente	
Capacidad	3850 mAh
Voltaje	17.6 V (máx.) 15.4 V (típico)
Tipo de batería	LiPo
Energía	59,29 Wh
Peso neto	Aprox. 297 g
Rango de temperaturas de carga	De 5 a 40 °C (de 41 a 104 °F)
Método de calentamiento	Manual/Auto
Rango de temperatura de calentamiento	de -20 a 6 °C (de -4 a 43 °F)
Tiempo de calentamiento	500 s (máx)
Potencia de calentamiento	55 W (máx)
• Cargador de Batería de Vuelo Inteligente	
Entrada	100-240 V; 50/60 Hz; 1.8 A
Salida	Red eléctrica: 17.6 V = 3.41 A o 17.0 V = 3.53 A USB: 5 V = 2 A
Potencia nominal	60 W



Para obtener más información, lea el manual del usuario:
www.dji.com/mavic-2-enterprice-advanced

※ Este contenido puede modificarse sin notificación previa.

MAVIC es una marca comercial de DJI.
 Copyright © 2021 DJI Todos los derechos reservados.

Impreso en China.

Appareil

DJI™ MAVIC™ 2 Enterprise Advanced comprend des systèmes optiques et des systèmes de détection infrarouge* omnidirectionnels, et est équipé d'une caméra nacelle à 3 axes entièrement stabilisée avec une caméra thermique et d'une caméra visuelle, fournissant simultanément des images infrarouges et visuelles. La technologie de détection d'obstacles de DJI aide les utilisateurs à voler et à capturer des images complexes tandis qu'AirSense permet de connaître l'espace aérien environnant et que la protection par mot de passe garantit l'accès à l'appareil et la sécurité de toutes les données. Mavic 2 Enterprise Advanced prend en charge un zoom numérique atteignant jusqu'à 32x et dispose d'un capteur d'imagerie thermique plus fluide doté d'une résolution nettement supérieure, ainsi que d'un capteur visuel de pixels plus élevés. L'appareil possède une vitesse de vol maximale de 72 km/h et un temps de vol maximum** de 31 minutes.

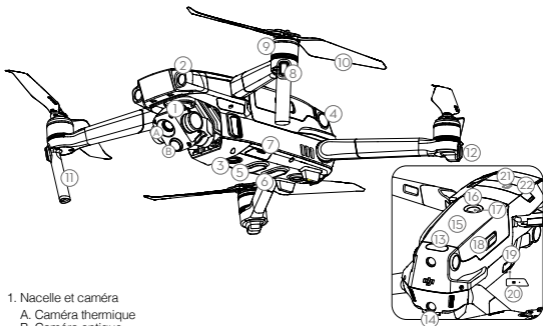

1. Nacelle et caméra

- A. Caméra thermique
- B. Caméra optique

2. Système optique avant

3. Système optique inférieur

4. Système optique latéral

5. Système de détection infrarouge vers le bas

6. Lampe inférieure

7. Logement de la carte microSD

8. LED avant

9. Moteurs

10. Hélices

11. Antennes

12. Voyant d'état de l'appareil

13. Système de détection infrarouge vers le haut

14. Système optique arrière

15. Batterie de Vol Intelligente

16. Indicateurs de niveau de batterie

17. Bouton d'alimentation

18. Bouton pressoir de la batterie

19. Port USB-C

20. Bouton d'appairage/voyant d'état d'appairage

21. Port d'extension (pour connecter les accessoires)

22. Couvercle port d'extension

* Les systèmes infrarouge et de vision sont influencés par les conditions environnantes. Pour plus d'informations, veuillez lire la Clause d'exclusion de responsabilité et les consignes de sécurité ainsi que le guide d'utilisateurs. <http://www.dji.com/mavic-2-enterprise-advanced>

** Le temps de vol maximum a été testé en l'absence de vent, à une vitesse constante de 25 km/h (15,5 mph). Cette valeur est fournie à titre indicatif uniquement.

Radiocommande Smart Controller de DJI

La DJI Smart Controller est une radiocommande conçue avec la technologie de transmission longue portée OCUSYNC™ 2.0 de DJI, offrant une portée de transmission maximale de 10 km et des images HD en direct depuis la caméra de l'appareil. La Smart Controller intègre un certain nombre de commandes de drone et de nacelle ainsi que des boutons personnalisables. La radiocommande intelligente possède également un écran intégré de 5,5 pouces à haute luminosité avec de multiples fonctions telles que Bluetooth et GNSS. Elle peut être connectée à Internet via Wi-Fi. La radiocommande dispose d'une autonomie de fonctionnement maximale de 2.5 heures*.

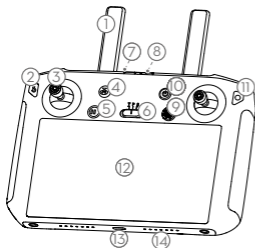

- 16. Bouton d'enregistrement
- 17. Port HDMI
- 18. Logement de la carte microSD
- 19. Port USB-A
- 20. Bouton de mise au point/de l'obturateur
- 21. Bouton de réglage de l'ouverture ou l'obturateur

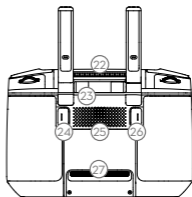

- 22. Ventilation
- 23. Emplacement de rangement des joysticks
- 24. Bouton personnalisable C2
- 25. Haut-parleur
- 26. Bouton personnalisable C1
- 27. Entrée d'air

- 1. Antennes
- 2. Bouton Retour/Bouton Fonction
- 3. Joysticks
- 4. Bouton RTH
- 5. Bouton de mise en pause du vol
- 6. Bouton de mode de vol
- 7. Voyant LED
- 8. Indicateurs de niveau de batterie
- 9. Bouton 5D
- 10. Bouton d'alimentation
- 11. Bouton de confirmation/
Bouton personnalisable C3
- 12. Écran tactile
- 13. Port USB-C
- 14. Microphone
- 15. Molette pour nacelle

* La Smart Controller est capable d'atteindre sa distance de transmission maximale (FCC) dans un espace dégagé sans interférence électromagnétique, à une altitude d'environ 120 m..

Le temps d'exécution maximum a été testé dans un environnement de laboratoire. Cette valeur est fournie à titre indicatif uniquement.

1. Préparation de l'appareil

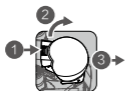

Retirez le cache de la nacelle de la caméra.



Dépliez les bras avant.



Dépliez les bras arrière.



Marqué



Non marqué

Associez les hélices aux moteurs correspondants.



Appuyez sur les hélices vers le bas et faites-les tourner jusqu'à ce qu'elles se mettent en place.



Déplié



Dépliez les bras avant et les hélices avant ceux situés à l'arrière. Tous les bras et les hélices doivent être dépliés avant le décollage.

2. Chargement des batteries

Chargez entièrement la Batterie de Vol Intelligente à l'aide du chargeur fourni avant la première utilisation.

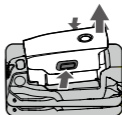

Retirez la Batterie de Vol Intelligente



Prise de courant
100 à 240 V



Chargeur de batterie



Temps de charge :
environ 1 heure et
30 minutes



Câble USB-C



Temps de charge :
environ 2 heures

Adaptateur secteur USB 24 W



Veuillez utiliser l'adaptateur secteur USB officiel de 24 W pour charger la Smart Controller. Si un adaptateur secteur USB standard de 24 W n'est pas disponible, il est recommandé d'utiliser un adaptateur secteur certifié FCC/CE de 12V/2A.

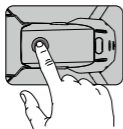

Appuyez une fois pour vérifier le niveau de la batterie.

Appuyez, puis maintenez enfoncé pour allumer/éteindre.

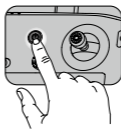

Faible Élevé



Appuyez une fois pour vérifier le niveau de batterie sur l'écran LCD.

Appuyez une fois, puis maintenez enfoncé pour allumer/éteindre la radiocommande.



Installez la batterie dans l'appareil et mettez-le sous tension. Une fois que la température de la batterie est inférieure à 6°C, elle se réchauffe automatiquement pour maintenir une température entre 8 et 10°C. Reportez-vous au guide d'utilisateur pour plus de détails.

3. Préparation de la radiocommande



Levez les antennes



Retirez les joysticks



Tournez pour installer les joysticks



La portée de transmission optimale est indiquée ci-dessus. Vérifiez que les antennes sont tournées vers l'appareil. Un angle de 80° ou 180° entre les antennes et l'arrière de la Smart Controller assure une connexion optimale entre l'appareil et la Smart Controller.



- Assurez-vous que les manches de contrôle sont bien en place.
- En fonctionnement réel, l'application DJI Pilot vous avertira si le signal de transmission devient faible. Dans ce cas, ajustez les antennes pour retrouver la portée de transmission optimale.

4. Préparation au décollage



Mettez la radiocommande sous tension



Mettez l'appareil sous tension



Lancez DJI Pilot



Internet

Utilisez un compte DJI pour activer l'appareil et la Smart Controller. L'activation nécessite une connexion à Internet. Avant d'activer l'appareil sur DJI Pilot, allumez la Smart Controller et suivez les instructions d'activation.



Définissez un mot de passe pour le drone dans l'application DJI Pilot afin de sécuriser l'accès et de protéger vos données embarquées.

5. Vol

Avant de procéder au décollage, vérifiez dans DJI Pilot que la mention « Ready to Go » s'affiche dans la barre d'état de l'appareil.

Ready to Go (GPS)

• Décollage/atterrissage manuel

Commande de manche combinée pour démarrer/couper les moteurs



OU



Relevez lentement le manche gauche pour décoller.



Abaissez lentement le manche gauche jusqu'à ce que l'appareil touche le sol. Maintenez la position pendant quelques secondes pour couper les moteurs.



Coupez les moteurs en plein vol uniquement s'il s'agit d'un cas d'urgence dans lequel cette action peut réduire le risque de dommage ou de blessure. La méthode pour arrêter les moteurs peut être définies dans DJI Pilot.

* Fonctionnement de la radiocommande

Le contrôle de vol par défaut est connu sous le nom de Mode 2. Le manche gauche agit sur l'altitude et l'orientation de l'appareil, tandis que le manche droit contrôle ses mouvements vers l'avant, l'arrière, la gauche et la droite. La molette de la nacelle contrôle l'inclinaison de la caméra.

Manche gauche

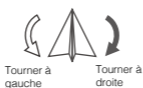

Manche droit



- Définissez toujours une altitude RTH appropriée avant le décollage. Lorsque l'appareil retourne au point de départ, guidez-le avec les manches de contrôle.
- Appuyez sur le bouton Pause de la fonction Vol pour effectuer un freinage d'urgence en plein vol.

* Accessoires modulaires



Phare M2E



Projecteur M2E



Haut-parleur M2E



Module RTK pour M2EA
(non fournie)

6. Voler en toute sécurité



Faire voler l'appareil dans des espaces ouverts

+



Signal GPS fort

+



Garder l'appareil en vue

+



Voler à moins de 120 m d'altitude (400 pieds)



Évitez de faire voler l'appareil au-dessus ou à proximité d'obstacles, de rassemblements de personnes, de lignes électriques à haute tension, d'arbres ou d'étendues d'eau. Ne faites PAS voler l'appareil à proximité de sources électromagnétiques puissantes, telles que des lignes électriques ou des antennes relais. Celles-ci risquent en effet d'affecter le compas intégré.



N'utilisez PAS l'appareil dans de mauvaises conditions météorologiques (pluie, neige, brouillard, rafales dont la vitesse dépasse 10 m/s ou 35 km/h [22 mph], etc.).



Tenez-vous à distance des hélices et des moteurs en rotation.



Zone d'exclusion aérienne

Pour en savoir plus, rendez-vous sur le site : <http://www.dji.com/flysafe>



Il est important que vous compreniez les consignes de vol fondamentales afin d'assurer votre sécurité et celle de votre entourage. N'oubliez pas de lire la **Clause d'exclusion de responsabilité et les consignes de sécurité**.

Caractéristiques techniques

• Appareil

Poids au décollage	909 g
Vitesse max.	72 km/h (Mode S, proche du niveau de la mer, sans vent)
Plafond pratique max. au-dessus du niveau de la mer	6 000 m
Plage de températures de fonctionnement	de -10° à 40 °C (14° à 104 °F)
GNSS	GPS + GLONASS
Fréquence de fonctionnement	2,4 à 2,4835 GHz ; 5,725 à 5,850 GHz
Puissance d'émission (EIRP)	2,4 GHz FCC: ≤26 dBm; CE/MIC: ≤20 dBm; SRRC: ≤20 dBm 5,8 GHz FCC : ≤26 dBm; CE : ≤14 dBm; SRRC : ≤26 dBm
Stockage interne	24 Go

• Nacelle

Plage réglable	Inclinaison : -90° à 30°
----------------	--------------------------

• Caméra thermique

Capteur	Microbolomètre VOx non refroidi
Distance focale de l'objectif	Env. 9 mm Équivalent : Env. 38 mm
Résolution du capteur	640 × 512 à 30 Hz
Zoom numérique	16x
Pas de pixel	12 µm
Bande spectrale	8 à 14 µm
Photo	R-JPEG
Vidéo	MP4
Méthode de mesure de la température	Mesure spot, mesure de zones
FFC	Auto/Manuel

• Caméra visuelle

Capteur	CMOS 1/2 po, Pixels effectifs : 48 millions
Objectif	FOV : env. 84° Équivalent : 24 mm Ouverture : f/2,8 Mise au point : 1 m à ∞
Gamme ISO	Vidéo : 100 à 12 800 (auto) Photo : 100 à 1 600 (auto)
Taille d'image maximale	8 000 × 6 000
Modes de photographie fixe	Prise de vue unique Intervalle (2/3/5/7/10/15/20/30/60 s) Pano : panorama sphérique
Modes d'enregistrement vidéo	3 840 × 2 160 à 30 ips 1 920 × 1 080 à 30 ips
Photo	JPEG

Vidéo	MP4
• Smart Controller	
Fréquence de fonctionnement	2,400 à 2,4833 GHz ; 5,725 à 5,850 GHz
Distance de transmission max. (sans obstacle ni interférence)	FCC : 10 km ; CE : 6 km ; SRRC : 6 km ; MIC : 6 km
Puissance de l'émetteur (EIRP)	2,4 GHz FCC : $\leq 25,5$ dBm ; CE/MIC : $\leq 18,5$ dBm ; SRRC : ≤ 19 dBm 5,8 GHz FCC : $\leq 25,5$ dBm ; CE : $\leq 12,5$ dBm ; SRRC : $\leq 18,5$ dBm
Capacité de stockage	ROM 16 Go + extensible (carte microSD)
Batterie	5 000 mAh à 7,2 V
Plage de températures de fonctionnement	-20 à 40 °C
Temps de charge	2 heures (avec un chargeur USB à 12V/2A)
Autonomie de la batterie	2,5 heures
Chargeur USB de 24 W	Entrée : 100 à 240 V, 50/60 Hz, Max 0,8 A Sortie : 3,6-8 V = 3,0 A / 12 V = 2,0 A
• Batterie de Vol Intelligente	
Capacité	3 850 mAh
Tension	17,6 V (max) 15,4 V (standard)
Type de batterie	LiPo
Énergie	59,29 Wh
Poids net	env. 297 g
Plage de températures de charge	de 5 à 40 °C
Méthodes de chauffage	Auto/Manuelle
Plage de températures de chauffage	-20 à 6 °C
Temps de chauffage	500 s (max.)
Puissance de chauffage	55 W (max.)
• Chargeur de Batterie de Vol Intelligente	
Entrée	100 à 240 V, 50/60 Hz ; 1,8 A
Sortie	Principale : 17,6 V = 3,41 A ou 17,0 V = 3,53 A USB : 5 V = 2 A
Puissance nominale	60 W



Pour en savoir plus, consultez le guide de l'utilisateur :

www.dji.com/mavic-2-enterprice-advanced

※ Ce contenu peut être modifié sans préavis.

MAVIC est une marque commerciale de DJI.

Copyright © 2021 DJI Tous droits réservés.

Imprimé en Chine.

Aeromobile

DJI™ MAVIC™ 2 Enterprise Advanced è dotato di sistemi di visione omnidirezionale e di rilevamento a infrarossi*, oltre a una fotocamera completamente stabilizzata a 3 assi con termocamera e telecamera visiva, per l'acquisizione simultanea di immagini sia a infrarossi sia visive. La tecnologia di rilevamento ostacoli di DJI assiste i piloti nel volo e nell'acquisizione di immagini complesse, mentre il sistema AirSense offre consapevolezza dello spazio aereo circostante e la password di protezione garantisce un accesso sicuro all'aeromobile e ai suoi dati. Mavic 2 Enterprise Advanced dispone di zoom digitale fino a 32x e ospita un sensore di immagini termiche più sensibile dalla risoluzione significativamente più elevata, così come più elevato è il numero di pixel del sensore visivo. L'aeromobile può raggiungere una velocità di volo massima di 72 km/h e un'autonomia** di 31 minuti di volo.

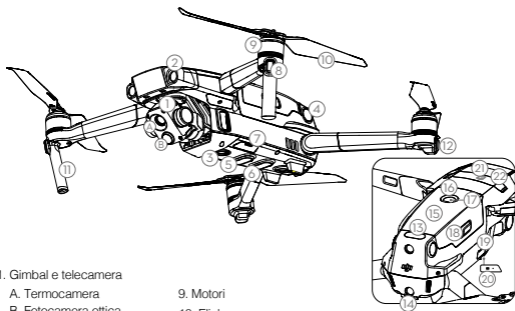

1. Gimbal e telecamera

- A. Termocamera
- B. Fotocamera ottica

2. Sistema visivo in avanti

3. Sistema visivo verso il basso

4. Sistema visivo laterale

5. Sistema di rilevamento a infrarossi verso il basso

6. Luce ausiliaria sulla parte inferiore

7. Slot per scheda micro-SD

8. LED anteriori

9. Motori

10. Eliche

11. Antenne

12. Indicatore di stato del velivolo

13. Sistema di rilevamento a infrarossi verso l'alto

14. Sistema visivo all'indietro

15. Batteria di volo intelligente

16. LED di livello di carica della batteria

17. Pulsante di accensione

18. Fermi della batteria

19. Porta USB-C

20. Pulsante di collegamento/ Indicatore di stato del collegamento

21. Porta per gli accessori (per collegare gli accessori)

22. Coperchio della porta per gli accessori

* I sistemi visivi e i sistemi di rilevamento a infrarossi vengono influenzati dalle condizioni circostanti. Per ulteriori informazioni, leggere la Dichiarazione di non responsabilità e le Linee guida sulla sicurezza e il Manuale utente. <http://www.dji.com/mavic-2-enterprise-advanced>

** Il tempo massimo di volo è stato testato in assenza di vento e a una velocità costante di 25 km/h (15,5 mph). Questo valore viene fornito soltanto come riferimento.

Radiocomando DJI Smart

Il radiocomando DJI Smart è stato integrato con OCUSYNC™ 2.0, la tecnologia di trasmissione a distanza che opera fino a un raggio di 10 km e trasmette immagini dal vivo in HD dalla fotocamera del velivolo. Il radiocomando DJI Smart offre l'utilizzo di diversi comandi per il velivolo e il gimbal, oltre a una serie di pulsanti personalizzabili, e presenta uno schermo 5,5" ad alta luminosità dotato di diverse funzionalità, come Bluetooth e GNSS. Supporta, inoltre, la connessione a internet tramite Wi-Fi. Il radiocomando DJI Smart ha un'autonomia operativa di 2.5 ore*.

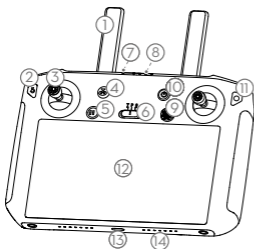

1. Antenne
2. Tasto Indietro/Tasto Funzione
3. Stick di controllo
4. Tasto RTH
5. Tasto di pausa del volo
6. Tasto selezione della modalità di volo
7. LED di stato
8. LED di carica della batteria
9. Tasto 5D
10. Tasto di accensione
11. Tasto Conferma / Tasto personalizzabile C3
12. Schermo touch
13. Porta USB-C
14. Microfono
15. Tasto di controllo del gimbal

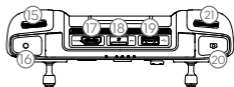

16. Tasto di registrazione
17. Porta HDMI
18. Slot per scheda microSD
19. Porta USB-A
20. Tasto di messa a fuoco / otturatore
21. Rotella di regolazione dell'apertura / otturatore

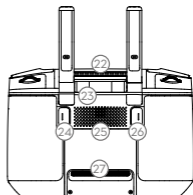

22. Bocchetta dell'aria
23. Comparto riposti-stick
24. Tasto personalizzabile C2
25. Altoparlante
26. Tasto personalizzabile C1
27. Presa d'aria

* Il radiocomando DJI Smart può raggiungere la sua massima distanza di trasmissione (a norma FCC) in aree aperte senza interferenze elettromagnetiche e a un'altitudine di circa 120 metri.

Il runtime massimo è testato in ambiente di laboratorio. Questo valore viene fornito soltanto come riferimento.

2. Preparazione del velivolo

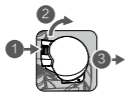

Rimuovere la protezione del gimbal dalla telecamera.



Dispiegare i bracci anteriori.



Dispiegare i bracci posteriori.



Contrassegnato Non contrassegnato
Far corrispondere le eliche ai motori



Premere le eliche verso il basso e ruotarle fino allo scatto.



Dispiegato



Dispiegare i bracci e le eliche anteriori prima di quelli posteriori. Tutti i bracci e le eliche devono essere dispiegati prima del decollo.

3. Ricarica delle batterie

Utilizzare il caricabatterie in dotazione per caricare completamente la batteria di volo intelligente prima di utilizzarla per la prima volta.

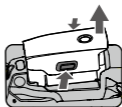

Rimuovere la batteria di volo intelligente

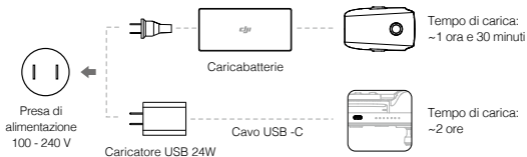

Si raccomanda di usare il caricatore USB 24W ufficiale per ricaricare il radiocomando DJI Smart. Qualora un caricatore USB 24W non fosse disponibile, si consiglia di usare un caricabatterie USB da 12V/2A certificato FCC/CE.

* Controllo dei livelli della batteria e accensione/spengimento

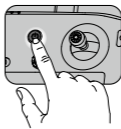
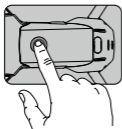

Basso Alto



Premere una volta per verificare il livello di carica della batteria.

Premere e tenere premuto per accendere/spengere.

Premere una volta per verificare il livello di carica della batteria sullo schermo LCD.

Premere una volta, quindi premere e tenere premuto per accendere/spengere il dispositivo di controllo remoto.



Installa la batteria sul velivolo e accendila. Se la temperatura della batteria si abbassa sotto i 6°C, questa inizierà a riscaldarsi automaticamente per mantenere una temperatura tra 8 e 10°C. Consultare il manuale d'uso per maggiori informazioni.

4. Preparazione del dispositivo di controllo remoto



Sollevere le antenne



Rimuovere gli stick



Ruotare gli stick per fissarli

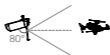

The optimal transmission range is shown above. Ensure the antennas are facing towards the aircraft. When the angle between the antennas and the back of the Smart Controller is 80° or 180°, the connection between the Smart Controller and the aircraft can reach its optimal performance.



- Accertarsi che le leve di comando siano montate saldamente.
- Durante il reale funzionamento, l'app DJI Pilot si attiverà per avvertire che il segnale di trasmissione è debole, e sarà necessario regolare le antenne per garantire che il velivolo torni all'interno del campo di trasmissione ottimale.

5. Preparazione al decollo



Accendere il dispositivo di controllo remoto



Accendere il velivolo



Lanciare l'app DJI Pilot



Internet

Usare un account DJI per attivare il velivolo e il radiocomando DJI Smart. L'attivazione richiede una connessione a internet. Prima di attivare il velivolo in DJI Pilot, accendere il radiocomando DJI Smart e seguire le istruzioni per l'attivazione.



Impostare una password per il velivolo nell'app DJI Pilot, per assicurare un accesso sicuro e proteggere i vostri dati durante il volo.

6. Volo

Prima del decollo, assicurarsi che la barra di stato del velivolo nell'app DJI Pilot indichi "Ready to Go".

Ready to Go (GPS)

* Decollo e atterraggio manuali

Combinazione di comandi da levette per avviare/arrestare i motori.



OPPURE



Portare la levetta sinistra (lentamente) verso l'alto per il decollo



Portare la levetta sinistra (lentamente) verso il basso finché non si tocca il suolo
Tenere premuto alcuni secondi per arrestare i motori



Arrestare i motori durante il volo solo in situazioni di emergenza e allo scopo di ridurre il rischio di danni o lesioni. L'opzione di blocco dei motori è disponibile tra le impostazioni di DJI Pilot.

* Funzionamento del dispositivo di controllo remoto

La modalità predefinita di controllo di volo è "Mode 2". La levetta sinistra controlla l'altitudine e la direzione del velivolo, mentre la levetta destra ne controlla i movimenti in avanti, all'indietro, a sinistra e a destra. Il quadrante del gimbal controlla l'inclinazione della telecamera.

Levetta sinistra

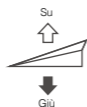

Levetta destra

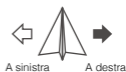

- Impostare sempre un'altitudine RTH adeguata prima del decollo. Quando il velivolo sta tornando al punto iniziale, è consigliabile guidarlo con le levette di comando.
- Premere il volo il pulsante Flight Pause per la frenata di emergenza durante il volo.

* Accessori modulari



Lampeggiante M2E



Riflettore M2E



Altoparlante M2E



Modulo RTK M2EA
(non inclusa nella confezione)

7. Fly Safe



Volare in zone aperte

+



Segnale GPS forte

+



Mantenere la linea di visione

+



Volare a un'altitudine inferiore a 120 m (400 piedi)



Evitare di volare al di sopra o in prossimità di ostacoli, folle, linee elettriche ad alta tensione, alberi e specchi d'acqua.

NON utilizzare il velivolo in prossimità di intense sorgenti elettromagnetiche quali linee elettriche e stazioni di base, in quanto tali sorgenti possono influenzare la bussola di bordo.



NON utilizzare il velivolo in condizioni meteorologiche avverse come pioggia, neve, nebbia e venti con velocità superiore a 10 m/s (22 mph).



Mantenere la distanza dalle eliche rotanti e dai motori.



Zona interdetta al volo

Per saperne di più:
<http://www.dji.com/flysafe>



Per la sicurezza propria e delle altre persone presenti nelle vicinanze, è importante comprendere le linee guida di base del volo. Ricordare di leggere le **Limitazioni di responsabilità e le direttive sulla sicurezza**.

Specifiche tecniche

• Aeromobile

Peso al decollo	909 g
Velocità massima	72 km/h (modalità S) (vicino al livello del mare, senza vento)
Quota massima di tangenza sopra il livello del mare	6.000 m
Intervallo di temperatura operativa	Da -10°C a 40°C
GNSS	GPS+GLONASS
Frequenza operativa	2.400 - 2.4835 GHz; 5.725 - 5.850 GHz
Potenza di trasmissione (EIRP)	2.4 GHz FCC: ≤26 dBm; CE/MIC: ≤20 dBm; SRRC: ≤20 dBm 5.8 GHz FCC: ≤26 dBm; CE: ≤14 dBm; SRRC: ≤26 dBm
Memoria interna	24 GB

• Stabilizzatore

Distanza controllabile	Inclinazione: da -90° a 30°
------------------------	-----------------------------

• Termocamera

Sensore	Microbolometro VOx non raffreddato
Lunghezza focale obiettivo	ca. 9 mm Equivalente: ca. 38 mm
Risoluzione del sensore	640x512 a 30 Hz
Zoom digitale	16x
Interasse	12 µm
Banda spettrale	8 -14 µm
Foto	R-JPEG
Video	MP4
Metodo di misurazione della temperatura	Misurazione parziale, misurazione area
FFC	Automatico/Manuale

• Telecamera visiva

Sensore	1/2" CMOS, pixel effettivi: 48 M
Obiettivo	FOV: ca. 84° Equivalente: 24 mm Apertura: f/2,8 Messa a fuoco: da 1 m a ∞
Intervallo ISO	Video: 100 - 12800 (automatico) Foto: 100 - 1600 (automatico)
Dimensione massima dell'immagine	8000x6000
Modalità fotografiche	Scatto singolo Intervallo (2/3/5/7/10/15/20/30/60 s) Pano: panorami sferici
Modalità di registrazione video	3840x2160 a 30 fps 1920x1080 a 30 fps

Foto	JPEG
Video	MP4
• Smart Controller	
Frequenza operativa	2.400 - 2.4835 GHz; 5.725 - 5.850 GHz
Massima distanza di trasmissione (senza ostacoli né interferenze)	FCC: 10 km; CE: 6 km; SRRC: 6 km; MIC: 6 km
Potenza del trasmettitore (EIRP)	2.4 GHz FCC: ≤25,5 dBm; CE/MIC: ≤18,5 dBm; SRRC: ≤19 dBm 5.8 GHz FCC: ≤25,5 dBm; CE: ≤12,5 dBm; SRRC: ≤18,5 dBm
Capacità di memoria	ROM 16 GB + scalabile (scheda microSD)
Batteria	5000 mAh a 7,2 V
Intervallo di temperatura operativa	tra -20°C e 40°C
Tempo di ricarica	2 ore (con caricabatterie USB a 12V/2A)
Durata della batteria	2,5 ore
Caricabatterie USB 24W	Ingresso: 100 - 240 V, 50 - 60 Hz, max. 0,8 A Uscita: 3,6 - 8 V = 3,0A/12V = 2,0 A
• Batteria di volo intelligente	
Capacità	3850 mAh
Tensione	17,6 V (max) 15,4 V (tipico)
Modello di batteria	LiPo
Energia	59,29 Wh
Peso netto	ca. 297 g
Temperatura di ricarica	Da 5°C a 40°C
Metodo di riscaldamento	Automatico/Manuale
Intervallo di temperatura di riscaldamento	Tra -20°C e 6°C
Tempo di riscaldamento	500 s (max)
Potenza riscaldante	55 W (max)
• Caricatore della batteria di volo intelligente	
Ingresso	100 - 240 V, 50 - 60 Hz, 1,8 A
Uscita	Primaria: 17,6 V = 3,41 A o 17,0 V = 3,53 A USB: 5 V = 2 A
Potenza nominale	60 W



Per ulteriori informazioni, consultare il Manuale utente:

www.dji.com/mavic-2-enterprice-advanced

※ Questi contenuti sono soggetti a modifiche senza preavviso.

MAVIC è un marchio registrato di DJI.

Copyright © 2021 DJI Tutti i diritti riservati.

Stampato in Cina.

Drone

De DJI™ MAVIC™ 2 Enterprise Advanced beschikt over omnidirectionele zichtsyste­men en infrarood detectiesyste­men*, en wordt geleverd met een volledig gestabiliseerde 3-assige gimbalcamera met een thermische camera en een visuele camera, die zowel infrarood als visuele beelden tegelijktijd levert. De Obstacle Sensing-technologie van DJI helpt gebruikers om te vliegen en complexe opnamen te maken, terwijl AirSense zorgt voor inzicht in het omringende luchtruim en wachtwoordbeveiliging zorgt voor toegang tot het vliegtuig en de veiligheid van alle gegevens. De Mavic 2 Enterprise Advanced ondersteunt tot 32x digitale zoom en heeft een soepeler warmtebeeldsensor met een aanzienlijk hogere resolutie en een visuele sensor met meer pixels. De drone heeft een maximale vliegsnelheid van maar liefst 72 km/u en een maximale vliegtijd** van 31 minuten.

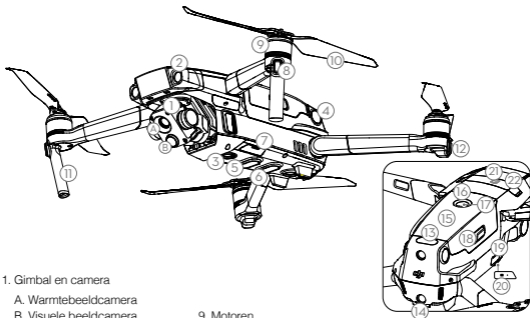

1. Gimbal en camera

- A. Warmtebeeldcamera
- B. Visuele beeldcamera

2. Vision System - naar voren

3. Vision System - naar beneden

4. Vision System - dwarsrichting

5. Naar beneden gericht infraroodsensorsysteem

6. Extra lampje onderaan

7. microSD-kaartsleuf

8. LED's voorzijde

9. Motoren

10. Propellers

11. Antennes

12. Statusindicator drone

13. Infraroodsensorsysteem

14. Vision System naar achteren

15. Intelligent Flight Battery

16. Accuniveau-leds

17. Aan-/uitknop

18. Accuaansluitingen

19. USB-C-poort

20. Koppeltoets/ koppelingstatusindicator

21. Uitbreidingspoort (voor het aansluiten van accessoires)

22. Afdekking uitbreidingspoort

* Het Vision System en infraroodsensorsysteem worden beïnvloed door omgevingsomstandigheden. Lees de disclaimer, de veiligheidsrichtlijnen en de gebruikershandleiding voor meer informatie. <http://www.dji.com/mavic-2-enterprise-advanced>

** De maximale vliegtijd is getest bij omstandigheden zonder wind en met een constante snelheid van 25 km/u (25,5 mph). Deze waarde geldt alleen ter referentie.

DJI Smart Controller

De DJI Smart Controller is een afstandsbediening gebouwd met de langeafstands-transmissietechnologie OCUSSYNC™ 2.0 van DJI, die een maximaal zendbereik van 10 km biedt en een live HD-weergave geeft van de camera van het vliegtuig. De Smart Controller wordt geleverd met een aantal bedieningselementen voor vliegtuigen en gimbals en een aantal aanpasbare knoppen, en heeft een ingebouwd 5,5-inch scherm met hoge helderheid en meerdere functies zoals Bluetooth en GNSS. Verbinding met internet via wifi wordt ook ondersteund. De maximale gebruiksduur van de Smart Controller bedraagt 2.5 uur*.

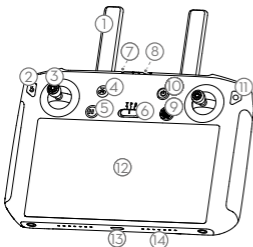

1. Antennes
2. Terugknop / Functieknop
3. Bedieningssticks
4. RTH-knop
5. Vluchtpauzeknop
6. Vluchtmodus-schakelaar
7. Status-LED
8. Accuniveau-LED's
9. 5D-knop
10. Aan-/uitknop
11. Bevestigingsknop / Aanpasbare knop C3
12. Aanraakscherm
13. USB-C-poort
14. Microfoon
15. Gimbal



16. Opnameknop
17. HDMI-poort
18. MicroSD-kaartsleuf
19. USB-A-poort
20. Scherpstellers- / Ontspanknop
21. Draaiknop instellingen sluiters / diafragma

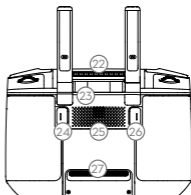

22. Ventilatieopening
23. Opslagplaats voor Bedieningssticks
24. Aanpasbare Knop C2
25. Luidspreker
26. Aanpasbare Knop C1
27. Luchtinlaat

* De Smart Controller kan de maximale overdrachtsafstand (FCC) bereiken in een grote open ruimte zonder elektromagnetische interferentie, en op een hoogte van circa 120 meter.

De maximale looptijd is getest in een laboratorium. Deze waarde geldt alleen ter referentie.

1. Drone voorbereiden

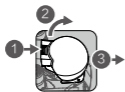

Verwijder de gimbal-afdekking van de camera.



Klap de voorarmen uit.



Klap de achterarmen uit.



Gemarkeerd Ongemarkeerd

Combineer de juiste propellers met de motoren.



Druk de propellers naar beneden en draai ze totdat ze op hun plaats klikken.



Uitgeklapt



Klap de voorarmen en de propellers uit vóór de achterste. Alle armen en propellers moeten uitgeklapt zijn voordat mag worden opgestegen.

TN

2. De accu's opladen

Gebruik de meegeleverde oplader om de Intelligent Battery volledig op te laden vóór het eerste gebruik.

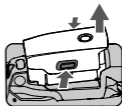

De Intelligent Flight Battery verwijderen

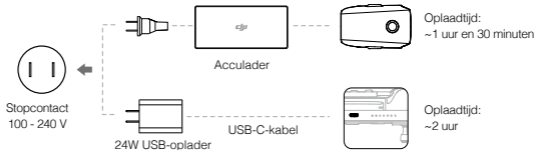

Gebruik alstublieft de officiële 24W USB-oplader om de Smart Controller op te laden. Wanneer een standaard 24W USB-oplader niet beschikbaar is, raden wij aan om een FCC/CE-gecertificeerde USB-oplader te gebruiken die geclassificeerd is als 12V/2A.

* Controleer het laadniveau van de accu en de aan/uit-schakelaar

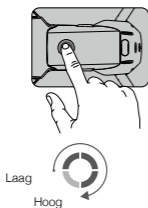

Druk eenmaal op de knop om het accuniveau te controleren.
Druk eenmaal en druk vervolgens opnieuw en houd vast om aan/uit te zetten.

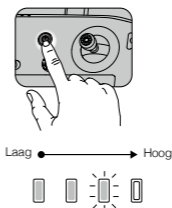

Druk eenmaal om het accuniveau op het LCD-scherm te controleren.
Druk eenmaal en druk vervolgens opnieuw en houd vast om de afstandsbediening aan/uit te zetten.

 Plaats de accu in de drone en schakel de drone in. Wanneer de accutemperatuur lager wordt dan 6 °C, zal deze automatisch worden opgewarmd tot een temperatuur tussen 8-10 °C. Raadpleeg de gebruikershandleiding voor meer informatie.

3. Voorbereiding van de afstandsbediening



Til de antennes op



Verwijder de bedieningssticks



Roteer om de bedieningssticks te bevestigen



The optimal transmission range is shown above. Ensure the antennas are facing towards the aircraft. When the angle between the antennas and the back of the Smart Controller is 80° or 180°, the connection between the Smart Controller and the aircraft can reach its optimal performance.



- Zorg dat de joysticks stevig zijn aangebracht.
- In de praktijk zal de DJI Pilot-app waarschuwen dat het transmissiesignaal zwak is, en dat de antennes aangepast dienen te worden om ervoor te zorgen dat het vliegtuig terugkeert naar het optimale transmissiebereik.

4. Voorbereiding voor opstijgen



Schakel de afstandsbediening in



Schakel het luchtvaartuig in



Start DJI Pilot



Internet

Gebruik een DJI-account om het vliegtuig en de Smart Controller te activeren. Activering vereist een internetverbinding. Zet de Smart Controller aan en volg de aanwijzingen voor het activeren voordat u het vliegtuig daadwerkelijk activeert in DJI Pilot.



Stel een wachtwoord in voor de drone in de DJI Pilot-app om veilige toegang te waarborgen en je boordgegevens te beschermen.

TN

5. Vlucht

Zorg er vóór het opstijgen voor dat de statusbalk van de drone in de DJI Pilot-app 'Ready to Go' aangeeft.

Ready to Go (GPS)

• Handmatig opstijgen/landen

Combination Stick Command (CSC) voor het starten/stoppen van de motoren



Linkerstick omhoog (langzaam) om op te stijgen



Linkerjoystick omlaag (langzaam) totdat u de grond raakt
Wacht enkele seconden om de motoren uit te schakelen



Schakel tijdens de vlucht de motoren alleen uit in noodsituaties, wanneer dit de kans op schade of letsel verkleint. De manier om de motor te stoppen kan worden ingesteld in DJI Pilot.

* Besturing met de afstandsbediening

De standaard vluchtregeling staat bekend als modus 2. Met de linkerjoystick regel je de hoogte en koers, terwijl je met de rechterjoystick vooruit, achteruit, naar links en rechts kunt bewegen. Met de gimbal regel je de kanteling van de camera.

Linkerjoystick



Omhoog



Omlaag



Linksaf



Rechtsaf

Rechterjoystick



Vooruit



Achteruit



Links



Rechts



- Stel altijd een passende RTH-hoogte in vóór het opstijgen. Als het luchtvaartuig terugkeert naar de basis, dien je het te begeleiden met de joysticks.
- Druk op de Flight Pause-knop om tijdens de vlucht een noodstop uit te voeren.

* Modulaire accessoires



M2E Baken



M2E Spotlicht



M2E Luidspreker



M2EA RTK-module
(niet inbegrepen)

6. Vlieg veilig



Vlieg in open gebieden



Krachtig GPS-signaal



Houd je drone in het zicht



Vlieg lager dan 120 m (400 feet)



Vermijd vliegen boven of nabij obstakels, drukte, hoogspanningsleidingen, bomen of water.

Vlieg NIET in de buurt van sterke elektromagnetische bronnen zoals elektriciteitsleidingen en basisstations, daardoor kan het ingebouwde kompas ongunstig worden beïnvloed.



Gebruik de drone NIET bij ongunstige weersomstandigheden zoals regen, sneeuw, mist en bij windsnelheden van meer dan 10 m/s of 22 mph.



Blijf uit de buurt van de roterende propellers en motoren.



No-fly zone

Meer informatie vind je op: <http://www.dji.com/flysafe>



Het is belangrijk de basisvluchtrichtlijnen te begrijpen voor je veiligheid en die van je medemens. Vergeet niet de **disclaimer en veiligheidsrichtlijnen te lezen**.

Technische gegevens

• Drone

Startgewicht	909 g
Max. snelheid	72 km/u (S-stand) (dicht bij zeeniveau, geen wind)
Max. servicehoogte boven zeeniveau	6000 m
Bedrijfstemperatuurbereik	-10 tot 40 °C
GNSS	GPS+GLONASS
Bedieningsfrequentie	2,4-2,4835 GHz; 5,725-5,850 GHz
Transmissievermogen (EIRP)	2,4 GHz FCC: ≤26 dBm; CE/MIC: ≤20 dBm; SRRC: ≤20 dBm 5,8 GHz FCC: ≤26 dBm; CE: ≤14 dBm; SRRC: ≤26 dBm
Interne opslag	24 GB

• Gimbal

Bestuurbaar bereik	Kantelen: -90 tot 30°
--------------------	-----------------------

• Thermische camera

Sensor	Ongekoelde VOx-microbolometer
Brandpuntsafstand lens	ong. 9 mm Gelijkwaardig: ong. 38 mm
Sensorresolutie	640×512 bij 30 Hz
Digitale zoom	16x
Pixelpitch	12 µm
Spectrale band	8-14 µm
Foto	R-JPEG
Video	MP4
Methode voor temperatuurmeting	Spotmeter, oppervlaktemeting

FFC	Automatisch/handmatig
-----	-----------------------

• Beeldcamera

Sensor	1/2" CMOS, effectieve pixels: 48 M
Lens	Gezichtsvelde: ca. 84° Gelijkwaardig: 24 mm Diafragma: f/2,8 Focus: 1 m tot ∞
ISO-bereik	Video: 100–12800 (automatisch) Foto: 100–1600 (automatisch)
Maximale beeldgrootte	8000×6000
Fotografeerstanden	Enkelvoudige opname Interval (2/3/5/7/10/15/20/30/60 sec) Pano: sferisch panorama
Video-opnamemodi	3840×2160 bij 30 fps 1920×1080 bij 30 fps
Foto	JPEG

Video	MP4
• Smart controller	
Bedieningsfrequentie	2,400-2,483 GHz; 5,725-5,850 GHz
Max. zendbereik (vrij van obstakels en interferentie)	FCC: 10 km; CE: 6 km; SRRC: 6 km; MIC: 6 km
Zendervermogen (EIRP)	2,4 GHz FCC: ≤25,5 dBm; CE/MIC: ≤18,5 dBm; SRRC: ≤19 dBm 5,8 GHz FCC: ≤25,5 dBm; CE: ≤12,5 dBm; SRRC: ≤18,5 dBm
Opslagcapaciteit	ROM 16 GB + uitbreidbaar (microSD-kaart)
Accu	5000 mAh bij 7,2 V
Bedrijfstemperatuurbereik	-20 tot 40 °C
Oplaadtijd	2 uur (met een USB-lader van 12 V / 2 A)
Accudoor	2,5 uur
24W USB-lader	Ingang: 100-240 V, 50-60 Hz, max. 0,8 A Uitgang: 3,6-8 V = 3,0 A / 12 V = 2,0 A
• Intelligent Flight Battery	
Capaciteit	3850 mAh
Spanning	17,6 V (max) 15,4 V (normaal)
Type accu	LiPo
Vermogen	59,29 Wh
Nettogewicht	Circa 297 g
Bereik van oplaadtemperatuur	5 tot 40 °C
Verwarmingsmethode	Handmatig/automatisch
Bereik verwarmingstemperatuur	-20 tot 6 °C
Opwarmtijd	500 sec. (max.)
Verwarmingsvermogen	55 W (max.)
• Lader Intelligent Flight Battery	
Ingang	100-240 V, 50-60 Hz, 1,8 A
Uitgang	Voeding: 17,6 V = 3,41 A or 17,0 V = 3,53 A USB: 5 V = 2 A
Nominaal vermogen	60 W



Lees de gebruikershandleiding voor meer informatie:
www.dji.com/mavic-2-enterprice-advanced

※ Deze inhoud is onderhevig aan wijzigingen zonder voorafgaande kennisgeving.

MAVIC is een handelsmerk van DJI.

Copyright © 2021 DJI Alle rechten voorbehouden.

Gedrukt in China.

Aeronave

O DJI™ MAVIC™ 2 Enterprise Advanced inclui sistemas de visão omnidirecional e sistemas de detecção de infravermelhos*, e vem com uma câmara de suspensão cardã de 3 eixos totalmente estabilizada com uma câmara térmica e uma câmara visual, proporcionando simultaneamente imagens de infravermelhos e de luz visível. A tecnologia de detecção de obstáculos da DJI ajuda os utilizadores a efetuarem voos e captarem imagens complexas, enquanto o AirSense fornece conhecimentos do espaço aéreo circundante e a proteção por palavra-passe assegura o acesso à aeronave e que todos os dados estão seguros. A Mavic 2 Enterprise Advanced suporta zoom digital de até 32x e tem um sensor de imagem térmico mais suave, com uma resolução significativamente mais elevada, bem como um sensor visual com mais pixéis. A aeronave conta com uma velocidade de voo máxima de 72 km/h (44,7 mi/h) e um tempo de voo máximo** de 31 minutos.

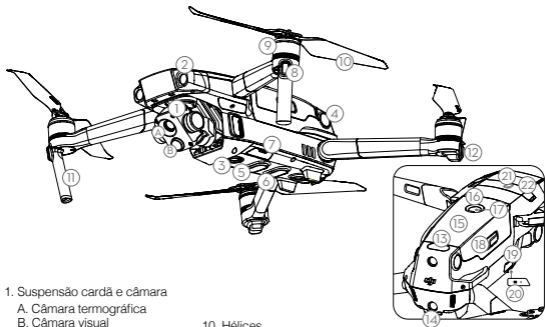

1. Suspensão cardã e câmara

A. Câmara termográfica

B. Câmara visual

2. Sistema de visão para a frente

3. Sistema de visão para baixo

4. Sistema de visão lateral

5. Sistema de detecção de infravermelhos para baixo

6. Luz auxiliar inferior

7. Ranhura para cartão microSD

8. LED frontais

9. Motores

10. Hélices

11. Antenas

12. Indicador de estado da aeronave

13. Sistema de detecção de infravermelhos para cima

14. Sistema de visão para trás

15. Bateria de voo inteligente

16. LED de nível da bateria

17. Botão de alimentação

18. Fivelas da bateria

19. Porta USB-C

20. Botão de ligação/Indicador de estado da ligação

21. Porta alargada (para ligar acessórios)

22. Tampa da porta alargada

* Os Sistemas de visão e os Sistemas de detecção de infravermelhos são afetados pelas condições ambiente. Leia a Declaração de exoneração de responsabilidade e diretrizes de segurança e o Manual do utilizador para saber mais. <http://www.dji.com/mavic-2-enterprise-advanced>

** O tempo máximo de voo foi testado num ambiente sem vento e a uma velocidade de voo constante de 25 km/h (15,5 mi/h). Este valor serve meramente como referência.

DJI Smart Controller

O DJI Smart Controller é um controlador remoto construído com a tecnologia OCUSSYNC™ 2.0 de transmissão de longo alcance da DJI, oferecendo um alcance máximo de transmissão de 6.2 milhas (10 km) e oferece uma visualização HD ao vivo da câmara da aeronave. O Smart Controller vem com vários controlos de aeronaves e cardã, assim como botões personalizáveis e possui um ecrã de alto brilho de 5,5 polegadas incorporado com múltiplas funções, como Bluetooth e GNSS. A ligação à Internet via Wi-Fi também é suportada. O Smart Controller tem uma autonomia máxima de 2.5 horas*.

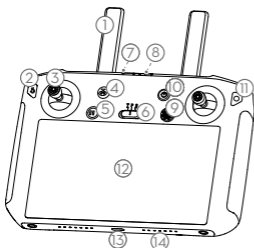

1. Antenas
2. Botão Voltar / Botão de Função
3. Manipulos
4. Botão RTH
5. Botão de pausa do voo
6. Interruptor de modo de voo
7. LED de estado
8. LED de nível da bateria
9. Botão 5D
10. Botão de alimentação
11. Botão de Confirmação / Botão Personalizável C3
12. Ecrã tátil
13. Porta USB-C
14. Microfone
15. Botão da suspensão cardã



16. Botão de gravação
17. Porta HDMI
18. Ranhura para cartão microSD
19. Porta USB-A
20. Botão de focagem / obturador
21. Seletor de ajuste de obturador/abertura

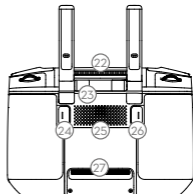

22. Saída de ar
23. Compartimento de armazenamento de manipululos
24. Botão C2 personalizável
25. Speaker
26. Botão C1 personalizável
27. Entrada de ar

* O Smart Controller consegue alcançar a sua distância máxima de transmissão (FCC) numa área ampla e aberta, sem interferência eletromagnética, a uma altitude de cerca de 120 metros (400 pés). O tempo máximo de funcionamento é testado em ambiente de laboratório. Este valor serve meramente como referência.

1. Preparar a aeronave

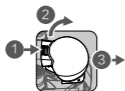

Retire a cobertura da suspensão cardã da câmara.



Desdobre os braços dianteiros.



Desdobre os braços traseiros.



Com marcas Sem marcas

Faça corresponder as hélices aos motores.



Pressione as hélices para baixo e rode-as até ouvir um clique.



Desdobrados



Desdobre os braços dianteiros e as hélices antes dos traseiros. Todos os braços e hélices têm de ser desdobrados antes de descolar.

2. Carregamento das baterias

Utilize o carregador fornecido para carregar completamente a bateria de voo inteligente antes da primeira utilização.

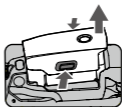

Remova a bateria de voo inteligente



Use o carregador USB 24W oficial para carregar o Smart Controller. Quando um carregador USB 24W padrão não estiver disponível, recomenda-se usar um carregador USB com certificação FCC/CE classificado como 12V/2A.

* Verificar os níveis da bateria e ligar/desligar

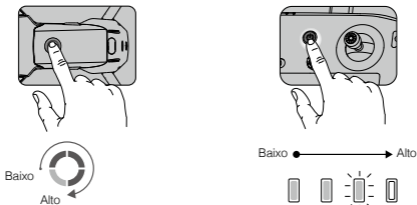

Prima uma vez para verificar o nível da bateria. Prima e, em seguida, prima e mantenha premido para ligar/desligar.

Prima uma vez para verificar o nível da bateria no ecrã LCD.

Prima uma vez e, em seguida, prima e mantenha premido para ligar/desligar o telecommando.



Instale a bateria na aeronave e ligue-a. Quando a temperatura da bateria for inferior a 6 °C, a mesma vai aquecer automaticamente para manter uma temperatura entre 8 e 10 °C. Consulte o Manual do utilizador para obter mais informações.

3. Preparar o telecommando



Levante as antenas



Remova os manipuladores



Rode para prender os manipuladores



A faixa ótima de transmissão é mostrada acima. Certifique-se de que as antenas estão voltadas para a aeronave. Quando o ângulo entre as antenas e a parte posterior do Comando inteligente é de 80° ou 180°, a conexão entre o Comando inteligente e a aeronave pode atingir o seu desempenho ideal.



- Certifique-se de que os manipuladores de controlo estão firmemente montados.
- Em operação real, a aplicação DJI Pilot avisa que o sinal de transmissão está fraco e ajuste as antenas para garantir que a aeronave esteja de volta à faixa ideal de transmissão.

4. Preparar a descolagem



Ligue o telecomando



Ligue a aeronave



Inicie a DJI Pilot



Internet

Use uma conta DJI para ativar a aeronave e o Smart Controller. A ativação requer uma ligação à Internet. Antes de ativar a aeronave no DJI Pilot, ligue o Smart Controller e siga as instruções para ativar.



Defina uma palavra-passe para a aeronave na aplicação DJI Pilot para garantir o acesso seguro à mesma e para proteger os seus dados a bordo.

5. Voo

Antes de descolar, assegure-se de que a barra de estado da aeronave na aplicação DJI Pilot indica "Ready to Go".

Ready to Go (GPS)

• Descolagem/Aterragem manual

Comando de manipuladores combinados para ligar/desligar os motores



OU



Desloque lentamente o manipulador esquerdo para cima para descolar



Desloque lentamente o manipulador esquerdo para baixo até que a aeronave toque no solo. Mantenha premido durante alguns segundos para parar os motores.



Para os motores durante o voo apenas em situações de emergência, sempre que seja necessário fazê-lo para minimizar os riscos de danos ou ferimentos. O método para parar o motor pode ser definido no DJI Pilot.

• Operação do telecomando

O controlo de voo predefinido é conhecido como Modo 2. O manípulo esquerdo controla a altitude e o rumo da aeronave e o manípulo direito controla os movimentos para a frente, para trás, para a esquerda e para a direita. O botão da suspensão cardíaca controla a inclinação da câmara.

Manípulo esquerdo

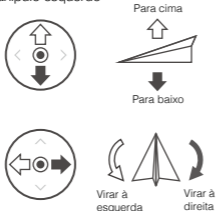

Manípulo direito

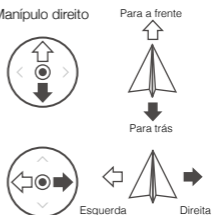

- Defina sempre uma altitude RTH adequada antes da decolagem. Quando a aeronave está a voltar ao ponto inicial, deverá dirigi-la com os manípulos de controlo.
- Prima o botão de pausa do para travagens de emergência durante o voo.

• Acessórios modulares



Farol M2E



Foco M2E



Altifalante M2E



Módulo M2EA RTK
(não incluído)

6. Voar com segurança



Voar em áreas abertas

+



Sinal de GPS forte

+



Manter a linha de visão

+



Voar abaixo dos 120 m (400 pés)



Evite voar por cima ou perto de obstáculos, multidões, linhas elétricas de alta tensão, árvores e massas de água.

NÃO voe próximo de fontes eletromagnéticas fortes, tais como linhas de alta tensão e estações de rede móvel, pois estas podem afetar a bússola integrada.



NÃO utilize a aeronave em condições atmosféricas adversas, tais como chuva, neve, nevoeiro e ventos com velocidades superiores a 10 m/s ou 35,4 km/h.



Mantenha-se afastado das hélices e dos motores em rotação.



Zona de exclusão aérea

Saiba mais em:
<http://www.dji.com/flysafe>



É importante compreender as diretrizes básicas de voo para a segurança do utilizador e dos que o rodeiam. Não se esqueça de ler a **Declaração de exoneração de responsabilidade e as diretrizes de segurança**.

Especificações

• Aeronave

Peso de decolagem	909 g
Velocidade máxima	72 km/h (modo S) (próximo do nível do mar, sem vento)
Limite de funcionamento máximo acima do nível do mar	6000 m
Intervalo de temperaturas de funcionamento	14 °F a 104 °F (-10 °C a 40 °C)
GNSS	GPS+GLONASS
Frequência de funcionamento	2,4-2,4835 GHz; 5,725-5,850 GHz
Potência da transmissão (EIRP)	2,4 GHz FCC: ≤26 dBm; CE/MIC: ≤20 dBm; SRRC: ≤20 dBm 5,8 GHz FCC: ≤26 dBm; CE: ≤14 dBm; SRRC: ≤26 dBm
Armazenamento interno	24 GB

• Suspensão cardã

Amplitude controlável	Inclinação: -90° a 30°
-----------------------	------------------------

• Câmara térmica

Sensor	Microbolómetro VOx não refrigerado
Intervalo focal da lente	Aprox. 9 mm Equivalente: Aprox. 38 mm
Resolução do sensor	640×512 @30Hz
Zoom Digital	16x
Distância entre pixéis	12 µm
Banda espectral	8-14 µm
Fotografia	R-JPEG
Vídeo	MP4
Método de medição da temperatura	Medidor de Ponto, Medição de área
FFC	Auto/Manual

• Câmara visual

Sensor	CMOS de 1/2", pixéis reais: 48 M
Lente	FOV: aprox. 84° Equivalente: 24 mm Abertura: f/2.8 Foco: 1 m a ∞
Gama de ISO	Vídeo: 100-12800 (auto) Foto: 100-1600 (auto)
Tamanho máximo da imagem	8000×6000
Modos de fotografia	Disparo único Intervalo (2/3/5/7/10/15/20/30/60 s) Panorâmico: panorama esférico
Modos de gravação de vídeo	3840×2160@30fps 1920×1080@30fps
Fotografia	JPEG

Vídeo MP4

• Controlador Inteligente

Frequência de funcionamento	2,400-2,483 GHz; 5,725-5,850 GHz
Distância máxima de transmissão (desobstruída, sem interferências)	FCC: 10 km; CE: 6 km; SRRC: 6 km; MIC: 6 km
Alimentação do transmissor (EIRP)	2,4 GHz FCC: $\leq 25,5$ dBm; CE/MIC: $\leq 18,5$ dBm; SRRC: ≤ 19 dBm 5,8 GHz FCC: $\leq 25,5$ dBm; CE: $\leq 12,5$ dBm; SRRC: $\leq 18,5$ dBm
Capacidade de armazenamento	ROM 16 GB + Escalonável (cartão microSD)
Bateria	5000 mAh @ 7,2 V
Intervalo de temperaturas de funcionamento	-4 °F a 104 °F (-20 °C a 40 °C)
Tempo de carregamento	2 horas (com um carregador por USB a 12 V/2 A)
Duração da bateria	2,5 horas
Carregador USB 24W	Entrada: 100-240 V, 50-60 Hz, máx. 0,8 A Saída: 3,6-8 V \approx 3,0 A/12 V \approx 2,0 A

• Bateria de voo inteligente

Capacidade	3850 mAh
Tensão	17,6 V (máx) 15,4 V (típico)
Tipo de bateria	LiPo
Energia	59,29 Wh
Peso líquido	Aprox. 297 g
Intervalo de temperatura de carregamento	41 °F a 104 °F (5 °C a 40 °C)
Método de aquecimento	Manual/Auto
Intervalo de temperaturas de aquecimento	-4 °F a 43 °F (-20 °C a 6 °C)
Tempo de aquecimento	500 s (máx.)
Potência de aquecimento	55 W (máx.)

• Carregador de bateria de voo inteligente

Entrada	100-240 V, 50-60 Hz, 1,8 A
Saída	Principal: 17,6 V \approx 3,41 A ou 17,0 V \approx 3,53 A USB: 5 V \approx 2 A
Potência nominal	60 W



Para mais informações, consulte o manual do utilizador:
www.dji.com/mavic-2-enterprice-advanced

※ Este conteúdo está sujeito a alterações sem aviso prévio.

MAVIC é uma marca comercial da DJI.

Copyright © 2021 DJI Todos os direitos reservados.

Impresso na China.

Aeronave

O DJI™ MAVIC™ 2 Enterprise Advanced apresenta sistemas visuais omnidirecionais e sistemas de detecção por infravermelho*, contando com uma câmera com estabilizador triaxial totalmente estabilizado, uma câmera termográfica com infravermelho de ondas longas e uma câmera visual, fornecendo imagens por infravermelho e visuais simultaneamente. A tecnologia de detecção de obstáculos da DJI ajuda usuários a voar e capturar imagens complexas, enquanto o AirSense permite tomar conhecimento do espaço aéreo circundante e a proteção por senha garante o acesso à aeronave, mantendo todos os dados em segurança. O Mavic 2 Enterprise Advanced suporta zoom digital de até 32x e possui um sensor de imagem térmica mais suave com resolução significativamente maior, bem como um sensor visual de pixels maior. A aeronave alcança uma velocidade máxima de voo de 72 km/h e tempo máximo de voo** de 31 minutos.

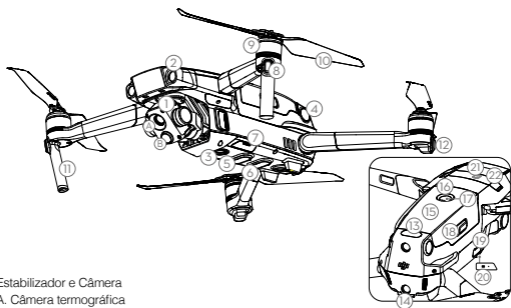

- | | | |
|---|---|---|
| 1. Estabilizador e Câmera
A. Câmera termográfica
B. Câmera visual | 10. Hélices | 19. Porta USB-C |
| 2. Sistema de visão frontal | 11. Antenas | 20. Botão Link/Indicador de status da câmera |
| 3. Sistema de visão inferior | 12. Indicador de status da aeronave | 21. Porta de extensão (para acoplar acessórios) |
| 4. Sistema de visão lateral | 13. Sistema de Detecção Infravermelho voltado para cima | 22. Tampa da porta de extensão |
| 5. Sistema de Detecção Infravermelho voltado para baixo | 14. Sistema de visão traseiro | |
| 6. Luz inferior auxiliar | 15. Bateria de Voo Inteligente | |
| 7. Slot de cartão microSD | 16. LEDs de nível de bateria | |
| 8. LEDs dianteiros | 17. Botão liga/desliga | |
| 9. Motores | 18. Fivelas da bateria | |

* Os Vision Systems e os Sistemas de Detecção Infravermelho são afetados pelas condições circundantes. Para obter mais informações, leia a Isenção de Responsabilidade e Diretrizes de Segurança e o Manual do Usuário. <http://www.dji.com/mavic-2-enterprise-advanced>

** O tempo de voo máximo foi testado em condição de vento zero à velocidade constante de 15,5 mph (25 km/h). Esse valor é meramente para referência.

Controle Inteligente DJI

O Controle Inteligente DJI é um controle remoto fabricado com a tecnologia de transmissão de longo alcance da DJI, OCUSYNC™ 2.0, oferecendo um alcance máximo de transmissão de até 10 km e concedendo visualização ao vivo em HD diretamente da câmera da aeronave. O Controle Inteligente vem equipado com múltiplos controles de aeronaves e estabilizadores, assim como botões personalizáveis, possuindo uma tela integrada de 5,5 polegadas com alta luminosidade e várias funções, como Bluetooth e GNSS. Conexão à internet através de Wi-Fi também é suportada. O Controle Inteligente possui um tempo máximo de funcionamento de 2.5 horas*.

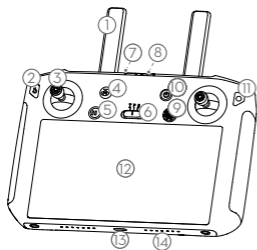

16. Botão de gravação
17. Porta HDMI
18. Entrada de cartão microSD
19. Porta USB-A
20. Botão Foco/Obturador
21. Abertura/botão de ajuste do obturador
22. Saída de ar

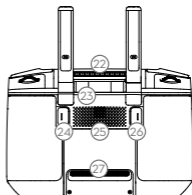

23. Compartimento de armazenamento dos pinos
24. Botão Personalizável C2
25. Alto-falante
26. Botão Personalizável C1
27. Entrada de ar

1. Antenas
2. Botão Voltar/Botão Função
3. Pinos
4. Botão RTH
5. Botão Pausa do voo
6. Interruptor Modo de voo
7. LED de status
8. LEDs de nível da bateria
9. Botão 5D
10. Botão Liga/Desliga
11. Botão Confirmar/botão Personalizável C3
12. Tela sensível ao toque
13. Porta USB-C
14. Microfone
15. Botão de rolagem do estabilizador

* O Controle Inteligente é capaz de alcançar sua distância máxima de transmissão (FCC) em áreas ao ar livre sem interferência eletromagnética, a uma altitude de até cerca de 120 m.

O tempo de uso máximo é testado em um ambiente de laboratório. Esse valor é meramente para referência.

1. Preparo da aeronave



Remova o grampo do estabilizador da câmera.



Desdobre os braços frontais.



Desdobre os braços traseiros.



Marcado Desmarcado
Corresponda as hélices aos motores.



Pressione as hélices para baixo e gire-as até que se encaixem no lugar certo.



Desdobrados



Desdobre os braços e as hélices frontais antes dos traseiros. Todos os braços e hélices devem ser desdobrados antes da decolagem.

2. Carga das baterias

Use o carregador fornecido para carregar totalmente a Bateria de Voo Inteligente antes de usar pela primeira vez.

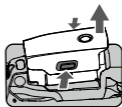

Remova a Bateria de Voo Inteligente

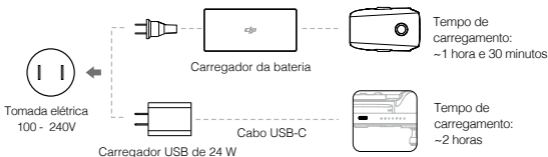

Favor utilizar o carregador USB de 24 W oficial para carregar o Controle Inteligente. Caso um carregador USB de 24 W padrão não esteja disponível, recomenda-se utilizar um carregador USB FCC/CE certificado com voltagem de 12 V/2 A.

* Verificação dos níveis da bateria e ligar/desligar

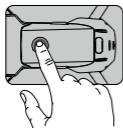

Pressione uma vez para verificar o nível da bateria.

Pressione uma vez; em seguida, novamente e segure para ligar/desligar.

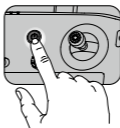

Baixo Alto



Pressione uma vez para verificar o nível da bateria na tela LCD.

Pressione uma vez e, em seguida, pressione e segure novamente para ligar/desligar o controle remoto.



Instale a bateria na aeronave e ligue-a. Uma vez que a temperatura da bateria for inferior a 6° C, entrará em aquecimento automático para manter uma temperatura entre 8° e 10° C. Confira o Manual do Usuário para obter mais detalhes.

3. Preparo do controle remoto



Levante as antenas



Remova os pinos



Gire para encaixar os pinos

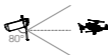

O alcance de transmissão ideal é exibido acima. Certifique-se de que as antenas estejam voltadas para a aeronave. Quando o ângulo entre as antenas e a parte posterior do Controle Inteligente for de 80° ou 180°, a conexão entre o Controle Inteligente e a aeronave poderá atingir seu desempenho ideal.



- Confira se os joysticks estão colocados firmemente.
- Em ação, o aplicativo DJI Pilot avisará que o sinal de transmissão está fraco e pedirá para ajustar as antenas para garantir que a aeronave volte ao alcance de transmissão ideal.

4. Preparação para a decolagem



Ligue o controle remoto.



Ligue a aeronave.



Inicie o DJI Pilot



Internet

Use uma conta da DJI para ativar a aeronave e o Controle Inteligente. Ativar requer conexão com a internet. Antes de ativar a aeronave no DJI Pilot, ligue o Controle Inteligente e siga as instruções de ativação.



Defina uma senha para a aeronave no aplicativo DJI Pilot para garantir um acesso seguro e proteger seus dados a bordo.

5. Voo

Antes da decolagem, verifique se a barra de status da aeronave no aplicativo DJI Pilot exibe "Ready to Go".

Ready to Go (GPS)

* Decolagem e pouso manuais

Combination Stick Command para ligar/desligar os motores



Joystick esquerdo para cima (lentamente) para decolar



Mova (lentamente) o joystick para baixo até tocar o chão
Segure por alguns segundos para parar os motores



Para diminuir o risco de danos ou ferimentos, só interrompa os motores em pleno voo em caso de emergência. O método para interromper o motor pode ser configurado no aplicativo DJI Pilot.

* Operação do controle remoto

O padrão de controle de voo é conhecido como Modo 2. O joystick esquerdo controla a altitude e a direção da aeronave, enquanto o joystick direito controla os movimentos para frente, para trás, para a esquerda e para a direita. O botão giratório do gimbal controla a inclinação da câmera.

Joystick esquerdo

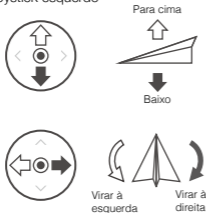

Joystick direito

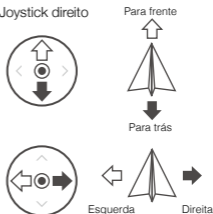

- Configure sempre uma altitude RTH adequada antes de decolar. Quando a aeronave estiver retornando ao Home Point, você deverá orientá-la com os joysticks.
- Pressione o botão Flight Pause para pausas de emergência durante o voo.

* Acessórios modulares



Farol M2E



Holofote M2E



Alto-falante M2E



Módulo RTK M2EA
(não incluído)

6. Voe com segurança



Voe em espaços abertos

+



Sinal de GPS forte

+



Mantenha o campo de visão

+



Voe abaixo de 120 m (400 pés)



Evite voar acima de ou próximo de obstáculos, multidões, linhas de alta tensão, árvores e corpos d'água.

NÃO voe próximo a fontes eletromagnéticas fortes, como linhas de energia e estações rádio base, pois isso pode afetar a bússola embarcada.



Não use a aeronave em condições climáticas adversas como chuva, neve, neblina e velocidades do vento acima de 10 m/s ou 22 mph.



Fique longe das hélices giratórias e dos motores.



Zona de exclusão aérea

Saiba mais em:
<http://www.dji.com/flysafe>



É importante que você compreenda as diretrizes básicas de voo, tanto para a sua proteção como para a segurança das pessoas à sua volta. Não se esqueça de ler a *isenção e as Diretrizes de segurança*.

Especificações

• Aeronave

Peso de decolagem	909 g
Velocidade máx.	72 km/h (modo S) (próximo ao nível do mar, sem vento)
Altura máx. de serviço acima do nível do mar	6000 m
Alcance da temperatura de funcionamento	-10 a 40 °C
GNSS	GPS+GLONASS
Frequências de funcionamento	2,4 a 2,4835 GHz; 5,725 a 5,850 GHz
Potência de transmissão (EIRP)	2,4 GHz FCC: ≤ 26 dBm; CE/MIC: ≤ 20 dBm; SRRC: ≤ 20 dBm 5,8 GHz FCC: ≤ 26 dBm; CE: ≤ 14 dBm; SRRC: ≤ 26 dBm
Armazenamento interno	24 GB

• Estabilizador

Alcance controlável	Inclinação: -90° a 30°
---------------------	------------------------

• Câmera termográfica

Sensor	Microbolômetro VOx sem ventilação
Distância focal da lente	Aprox. 9 mm Equivalente: Aprox. 38 mm
Resolução do sensor	640x512 a 30 Hz
Zoom digital	16x
Distância entre píxeis	12 µm
Alcance espectral	8 a 14 µm
Foto	R-JPEG
Vídeo	MP4
Métodos de medição de temperatura	Medidor de local/medição de área
FFC	Automático/Manual

• Câmera Visual

Sensor	CMOS de 1/2"; Píxeis efetivos: 48 M
Lente	Campo de visão: aprox. 84° Equivalente: 24 mm Abertura: f/2.8 Foco: 1 m a ∞
Alcance ISO	Vídeo: 100 a 12.800 (automático) Foto: 100 a 1600 (automático)
Dimensões máx. da imagem	8000x6000
Modos de fotografia	Disparo único Intervalo (2/3/5/7/10/15/20/30/60 s) Panorâmica: Panorâmica Esférica
Modos de gravação de vídeo	3840 × 2160 a 30 fps 1920 × 1080 a 30 fps
Foto	JPEG

Vídeo	MP4
• Controle Inteligente	
Frequência de funcionamento	2,400 a 2,483 GHz; 5,725 a 5,850 GHz
Distância máx. de transmissão (sem obstruções, livre de interferências)	FCC: 10 km; CE: 6 km; SRRC: 6 km; MIC: 6 km
Potência do transmissor (EIRP)	2,4 GHz FCC: $\leq 25,5$ dBm; CE/MIC: $\leq 18,5$ dBm; SRRC: ≤ 19 dBm 5,8 GHz FCC: $\leq 25,5$ dBm; CE: $\leq 12,5$ dBm; SRRC: $\leq 18,5$ dBm
Capacidade de armazenamento	ROM 16 GB + possibilidade de expansão (cartão microSD)
Bateria	5000 mAh a 7,2 V
Alcance da temperatura de funcionamento	-20° a 40 °C
Tempo de carregamento	2h (com um carregador USB de 12 V/2 A)
Duração da bateria	2,5 h
Carregador USB 24 W	Entrada: 100 a 240 V; 50 a 60 Hz, Máx. 0,8 A Saída: 3,6 a 8 V = 3,0 A/12 V = 2,0 A
• Bateria de Voo Inteligente	
Capacidade	3850 mAh
Tensão	17,6 V (máx.) 15,4 V (típica)
Tipo de bateria	LiPo
Energia	59,29 Wh
Peso líquido	Aprox. 297 g
Alcance da temperatura de carregamento	5° a 40 °C
Método de aquecimento	Automático/Manual
Alcance da temperatura de aquecimento	-20° a 6 °C
Tempo de aquecimento	500 s (máx.)
Potência do aquecimento	55 W (máx.)
• Carregador da Bateria de Voo Inteligente	
Entrada	100 a 240 V; 50 a 60 Hz; 1,8 A
Saída	Principal: 17,6 V = 3,41 A ou 17 V = 3,53 A USB: 5 V = 2 A
Potência nominal	60 W



Para mais informações, consulte o manual do usuário:

www.dji.com/mavic-2-enterprice-advanced

※ Este conteúdo está sujeito a alterações sem prévio aviso.

MAVIC é uma marca comercial da DJI.

Copyright © 2021 Todos os direitos reservados.

Impresso na China.

Дрон

MAVIC™ 2 Enterprise Advanced от DJI™ оснащен всенаправленными системами обзора и инфракрасными датчиками*, а также полностью стабилизированной 3-осевой камерой с тепловизионной камерой и оптической камерой, благодаря которым можно получать инфракрасные и визуальные изображения одновременно. Благодаря технологии сканера препятствий DJI пользователи могут запечатлеть сложные кадры в полете, в то время как AirSense информирует их об окружающем воздушном пространстве, а защита паролем обеспечивает безопасность доступа к дрону и всем данным. Mavic 2 Enterprise Advanced поддерживает цифровой зум с увеличением до 32 раз и оснащен инфракрасной термальной матрицей, позволяющей снимать плавные кадры с намного более высоким разрешением, а также более чувствительным оптическим датчиком. Максимальная скорость полета дрона составляет 72 км/ч, а максимальное время полета** — 31 минуту.

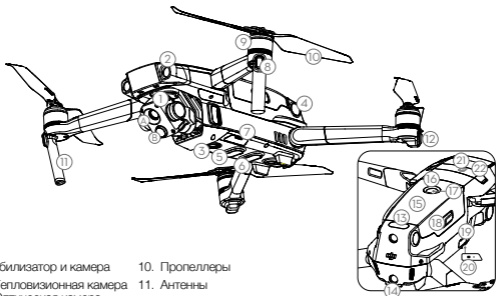

- | | |
|---|--|
| 1. Стабилизатор и камера | 10. Пропеллеры |
| А. Тепловизионная камера | 11. Антенны |
| В. Оптическая камера | 12. Индикатор состояния дрона |
| 2. Система переднего обзора | 13. Система верхних инфракрасных датчиков |
| 3. Система нижнего обзора | 14. Система заднего обзора |
| 4. Система бокового обзора | 15. Аккумулятор Intelligent Flight Battery |
| 5. Система нижних инфракрасных датчиков | 16. Светодиодные индикаторы уровня заряда аккумулятора |
| 6. Luz inferior auxiliar. | 17. Кнопка питания |
| 7. Слот для карты памяти microSD | 18. Зажимы крепления аккумулятора |
| 8. Передние огни | 19. Порт USB-C |
| 9. Электродвигатели | 20. Кнопка подключения/индикатор состояния подключения |
| | 21. Удлиненный порт (для подсоединения аксессуаров) |
| | 22. Удлиненная крышка для порта |

* Работа систем обзора и систем инфракрасных датчиков зависит от условий окружающей среды. Чтобы получить подробную информацию, перейдите в Заявление в Заявлении об отказе от ответственности, Правила техники безопасности и Руководство пользователя. <http://www.dji.com/mavic-2-enterprise-advanced>

** Результат, полученный во время испытаний при полете в безветренных условиях с постоянной скоростью 25 км/ч (15,5 мили/ч). Данное значение приведено исключительно в справочных целях.

Пульт DJI Smart Controller

DJI Smart Controller – пульт дистанционного управления с встроенной технологией передачи сигнала на дальние расстояния DJI OCUSSYNC™ 2.0. Максимальное значение передачи сигнала HD с камеры летательного аппарата составляет 10 км. Интеллектуальный пульт позволяет управлять летательным аппаратом и стабилизатором. Он оснащен настраиваемыми кнопками, встроенным 5,5-дюймовым высокоярким дисплеем а также такими функциями как Bluetooth и спутниковые системы позиционирования. Также поддерживается подключение к интернету через Wi-Fi. Максимальное время работы интеллектуального пульта составляет 2,5 часа*.

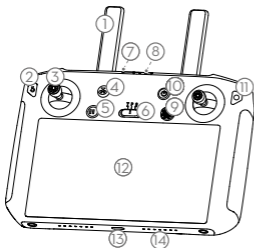

1. Антенны
2. Кнопка «Назад» / «Функция»
3. Джойстики
4. Кнопка возврата домой (RTH)
5. Кнопка остановки полета
6. Переключатель режимов полета
7. Светодиодный индикатор состояния
8. Светодиодные индикаторы уровня заряда аккумулятора
9. Кнопка 5D
10. Кнопка питания
11. Кнопка подтверждения / настраиваемая кнопка C3
12. Сенсорный экран
13. Порт USB-C
14. Микрофон
15. Колесико наклона камеры

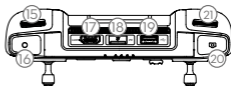

16. Кнопка записи
17. Порт HDMI
18. Слот для карты памяти microSD
19. Порт USB-A
20. Кнопка фокусировки / Кнопка спуска затвора
21. Регулятор диафрагмы/затвора

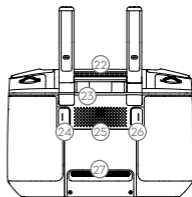

22. Вентиляционное отверстие
23. Слот для хранения джойстиков
24. Настраиваемая кнопка C2
25. Динамик
26. Настраиваемая кнопка C1
27. Воздухозаборник

* Пульт управления способен передавать сигнал на максимальное расстояние по стандарту FCC при соблюдении следующих условий: открытая местность без электро-магнитных помех, дрон летит на высоте 120 метров.

Максимальное время работы измерено в лабораторных условиях. Данное значение приведено исключительно в справочных целях.

2. Подготовка дрона



Снимите чехол стабилизатора с камеры.



Разложите передние лучи.



Разложите задние лучи.



С маркировкой Без маркировки

Соблюдайте цветовую кодировку пропеллеров и электродвигателей.



Нажмите на пропеллеры и поверните их до щелчка.



Разложенное состояние



Всегда раскладываете сначала передние лучи, затем — задние. Все лучи и пропеллеры должны находиться в разложенном состоянии перед взлетом.

3. Зарядка аккумуляторов

Используйте предоставленное в комплекте зарядное устройство, чтобы полностью зарядить аккумулятор Intelligent Flight Battery перед первым использованием.

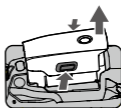

Снимите аккумулятор Intelligent Flight Battery



Используйте фирменное зарядное устройство USB на 24 Вт для зарядки интеллектуального пульта. Если фирменное зарядное устройство недоступно, рекомендуется использовать зарядное устройство USB, соответствующее стандарту FCC/CE, 12В/2А.

* Проверьте уровень заряда аккумуляторов и включите/выключите питание

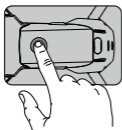

Нажмите один раз для проверки уровня заряда аккумулятора.
Нажмите один раз, затем нажмите и удерживайте для включения/выключения.

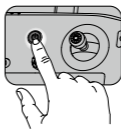

Низкий —————> Высокий



Нажмите один раз для проверки уровня заряда аккумулятора на ЖК-экране.

Нажмите один раз, затем нажмите и удерживайте для включения/выключения пульта дистанционного управления.



Установите аккумулятор в летательный аппарат и включите его. Если температура аккумулятора опустится ниже +6°C, он начнет нагреваться до достижения температуры +8...+10°C. Подробности см. в руководстве пользователя.

4. Подготовка пульта дистанционного управления к работе



Поднимите антенны



Снимите джойстики



Поверните, чтобы установить джойстики



Оптимальная дальность передачи сигнала указана выше. Убедитесь, что антенны направлены на летательный аппарат. Соединение между интеллектуальным пультом и дроном будет считаться оптимальным, когда угол между антеннами и задней панелью пульта составляет 80°...180°.



- Убедитесь, что джойстики надежно закреплены.
- Если приложение DJI Pilot выдает предупреждение о том, что сигнал слабый, необходимо поменять положение антенн для достижения оптимального значения дальности передачи сигнала.

5. Подготовка к взлету



Включите пульт дистанционного управления



Включите дрон



Запустите DJI Pilot



Интернет

Для активации летательного аппарата и интеллектуального пульта используйте учетную запись DJI. Необходимо подключение к интернету. Перед активацией летательного аппарата в приложении DJI Pilot включите интеллектуальный пульт и следуйте пошаговой инструкции.



Установите пароль для дрона в приложении DJI Pilot, чтобы обеспечить защиту доступа данных.

6. Полет

Перед взлетом убедитесь, что в строке состояния дрона в приложении DJI Pilot показано Ready to Go (Полет разрешен).

Ready to Go (GPS)

• Ручной взлет / посадка

Положение джойстиков для включения/выключения электродвигателей



ИЛИ



Плавное сдвигание левого джойстика вверх для взлета



Смещайте левый джойстик вниз (плавно), пока дрон не коснется поверхности.

Для выключения двигателей удерживайте джойстик в нижнем положении в течение нескольких секунд.



Выключайте моторы во время полета только в экстренных ситуациях, в которых это может быть необходимо для предотвращения травм и опасных ситуаций. Способ выключения мотора может быть задан в приложении DJI Pilot.

* Эксплуатация пульта дистанционного управления

Режим 2 является режимом управления по умолчанию. Левый джойстик используется для управления высотой и поворотом дрона, правый — для управления движением вперед, назад, влево и вправо. Колесико стабилизатора управляет наклоном камеры.

Левый джойстик



Вверх



Вниз



Поворот
налево



Поворот
направо

Правый джойстик

Вперед



Назад



Влево



Вправо



- Перед взлетом всегда устанавливайте подходящую высоту для возврата домой. При возврате в исходную точку дрон необходимо направлять с помощью джойстиков.
- Нажмите на кнопку остановки режима полета для аварийного торможения во время полета.

* Аксессуары



M2E Сигнальный огонь



M2E Проектор



M2E Динамик



Модуль RTK M2EA
(не входит в комплект)

7. Соблюдайте правила безопасности полетов



Выполняйте полеты на открытых участках

+



+



+



При сильном сигнале спутников

Выполняйте полет только в пределах прямой видимости

Выполняйте полет на высоте ниже 120 м (400 футов)



Следует избегать полетов над или в непосредственной близости от препятствий, скоплений людей, высоковольтных линий электропередачи, деревьев и водоемов. ЗАПРЕЩАЕТСЯ выполнять полеты близко от таких источников сильного электромагнитного поля, как линии электропередачи и базовые станции, т. к. они могут влиять на работу встроенного компаса.



ЗАПРЕЩАЕТСЯ использовать дрон в неблагоприятных погодных условиях, таких как дождь, снег, туман и при скорости ветра более 10 м/с или 22 миль/ч.



Не приближайтесь к вращающимся пропеллерам и электродвигателям.



Зоны, запрещенные для полетов

Более подробная информация приведена на веб-сайте: <http://www.dji.com/flysafe>



Для обеспечения своей безопасности и безопасности окружающих важно понимать основные принципы полета. Для получения дополнительной информации **обратитесь к отказу от ответственности и руководству по технике безопасности.**

Технические характеристики

• Дрон

Взлетная масса	909 г
Макс. скорость	72 км/ч (режим S) (на уровне моря в штиль)
Макс. высота полета над уровнем моря	6000 м
Диапазон рабочих температур	-10...40 °C
Спутниковые системы позиционирования	GPS + ГЛОНАСС
Диапазон рабочих частот	2,4–2,4835 ГГц
Мощность передатчика (ЭИИМ)	2,4 ГГц FCC: ≤ 26 дБм; CE/MIC: ≤ 20 дБм; SRRC: ≤ 20 дБм
Объем внутренней памяти	24 Гбайта

• Стабилизатор

Рабочий диапазон углов вращения	Наклон: -90°...30°
---------------------------------	--------------------

• Тепловизионная камера

Матрица	Микроболометр на оксиде ванадия (VOx)
Фокусное расстояние объектива	Около 9 мм Эквивалент: около 38 мм
Разрешение матрицы	640 × 512 при 30 Гц
Цифровой зум	16x
Шаг пикселя	12 мкм
Спектральный диапазон	8–14 мкм
Фото	R-JPEG
Видео	MP4
Метод измерения температуры	Точечный замер, измерение площади
FFC	Авто/вручную

• Оптическая камера

Матрица	CMOS 1/2 дюйма, число эффективных пикселей: 48 млн
Объектив	Угол обзора: около 84° Эквивалент: 24 мм Диафрагма: f/2,8 Фокус: от 1 м до ∞
Диапазон ISO	Видео: 100–12800 (авто) Фото: 100–1600 (авто)
Макс. размер изображения	8000 × 6000
Режимы фотосъемки	Покадровая Интервальная: (2/3/5/7/10/15/20/30/60 с) Пано: сферическая панорама
Режимы видеосъемки	3840 × 2160 со скоростью 30 кадров/с 1920 × 1080 со скоростью 30 кадров/с
Фото	JPEG
Видео	MP4

• Пульт Smart Controller

Диапазон рабочих частот	2,400–2,483 ГГц
Макс. дальность передачи сигнала (при отсутствии препятствий и помех)	FCC: 10 км; CE: 6 км; SRRC: 6 км; MIC: 6 км
Мощность передатчика (ЭИИМ)	2,4 ГГц FCC: ≤ 25,5 дБм; CE/MIC: ≤ 18,5 дБм; SRRC: ≤ 19 дБм
Объем памяти	ПЗУ 16 Гбайт + по индивидуальному заказу (карта памяти microSD)
Аккумулятор	5000 мА·ч при 7,2 В
Диапазон рабочих температур	–20...40 °С
Время зарядки	2 ч (с помощью зарядного устройства USB при 12 В / 2 А)
Время работы аккумулятора	2,5 часа
Зарядное устройство USB мощностью 24 Вт	Вход: 100–240 В, 50–60 Гц, макс. 0,8 А Выход: 3,6–8 В = 3,0 А / 12 В = 2,0 А

• Аккумулятор Intelligent Flight Battery

Емкость	3850 мА·ч
Напряжение	17,6 В (макс.) 15,4 В (обычное)
Тип аккумулятора	Литий-полимерный
Энергия	59,29 Вт·ч
Масса нетто	Около 297 г
Диапазон температур зарядки	5...40 °С
Способ нагревания	Вручную/авто
Диапазон температуры нагревания	–20...6 °С
Время нагревания	500 с (макс.)
Мощность нагревания	55 Вт (макс.)

• Зарядное устройство аккумулятора Intelligent Flight Battery

Вход	100–240 В, 50–60 Гц, 1,8 А
Выход	Главный: 17,6 В = 3,41 А или 17,0 В = 3,53 А USB: 5 В = 2 А
Номинальная мощность	60 Вт



Дополнительную информацию можно найти в руководстве пользователя:
www.dji.com/mavic-2-enterprice-advanced

※ Эта отметка означает, что содержание может быть изменено без предварительного уведомления.

MAVIC является товарным знаком компании DJI.

© 2021 DJI Все права защищены.

Напечатано в Китае.



WE ARE HERE FOR YOU

在线技术支持



Contact DJI SUPPORT
via Facebook Messenger



微信扫一扫
获取技术支持



4GCDMURM03TY