

Mobile Phone user manual

- Some of the contents in this manual may differ from your phone depending on the software of the phone or your service provider.
- Visit the Samsung website to view the Samsung Mobile function guide in Adobe Acrobat (.pdf) format. The function guide contains common topics about applications and features that appear in many different models of Samsung mobile phones.

www.samsungmobile.com

Printed in Korea
Code No.:GH68-29686A
English (IND), 06/2010, Rev. 1.1



Safety warnings

Keep your phone away from small children and pets

Keep your phone and all accessories out of the reach of small children or animals. Small parts may cause choking or serious injury if swallowed.

Protect your hearing



Excessive exposure to sound at high volumes can cause hearing damage. Always turn the volume down before plugging the earphones into an audio source and use only the minimum volume setting necessary to hear your conversation or music.

Install mobile phones and equipment with caution

Ensure that any mobile phones or related equipment installed in your vehicle are securely mounted. Avoid placing your phone and accessories near or in an air bag deployment area. Improperly installed wireless equipment can cause serious injury when air bags inflate rapidly.

Handle and dispose of batteries and chargers with care

- Use only Samsung-approved batteries and chargers specifically designed for your phone. Incompatible batteries and chargers can cause serious injuries or damage to your phone.
- Never dispose of batteries or phones in a fire. Follow all local regulations when disposing of used batteries or phones.
- Never place batteries or phones on or in heating devices, such as microwave ovens, stoves, or radiators. Batteries may explode when overheated.
- Never crush or puncture the battery. Avoid exposing the battery to high external pressure, which can lead to an internal short circuit and overheating.

Avoid interference with pacemakers

Maintain a minimum of 15 cm (6 inches) between mobile phones and pacemakers to avoid potential interference, as recommended by manufacturers and the independent research group, Wireless Technology Research. If you have any reason to suspect that your phone is interfering with a pacemaker or other medical device, turn off the phone immediately and contact the manufacturer of the pacemaker or medical device for guidance.

Turn off the phone in potentially explosive environments

Do not use your phone at refuelling points (service stations) or near fuels or chemicals. Turn off your phone whenever directed by warning signs or instructions. Your phone could cause explosions or fire in and around fuel or chemical storage and transfer areas or blasting areas. Do not store or carry flammable liquids, gases, or explosive materials in the same compartment as the phone, its parts, or accessories.

Reduce the risk of repetitive motion injuries

While using your phone, hold the phone with a relaxed grip, press the keys lightly, use special features that reduce the number of keys you have to press (such as templates and predictive text), and take frequent breaks.

Do not use the phone if the screen is cracked or broken

Broken glass or acrylic could cause injury to your hand and face. Bring the phone to a Samsung service centre to replace the screen. Damage caused by careless handling will void your manufacturer's warranty.

CE0168



Safety precautions

Drive safely at all times

Avoid using your phone while driving and obey all regulations that restrict the use of mobile phones while driving. Use hands-free accessories to increase your safety when possible.

Follow all safety warnings and regulations

Comply with any regulations that restrict the use of a mobile phone in a certain area.

Use only Samsung-approved accessories

Using incompatible accessories may damage your phone or cause injury.

Turn off the phone near medical equipment

Your phone can interfere with medical equipment in hospitals or health care facilities. Follow all regulations, posted warnings, and directions from medical personnel.

Turn off the phone or disable the wireless functions when in an aircraft

Your phone can cause interference with aircraft equipment. Follow all airline regulations and turn off your phone or switch to a mode that disables the wireless functions when directed by airline personnel.

Protect batteries and chargers from damage

- Avoid exposing batteries to very cold or very hot temperatures (below 0° C or above 45° C). Extreme temperatures can reduce the charging capacity and life of your batteries.
- Prevent batteries from contacting metal objects, as this can create a connection between the + and – terminals of your batteries and lead to temporary or permanent battery damage.
- Never use a damaged charger or battery.

Handle your phone carefully and sensibly

- Do not disassemble your phone due to a risk of electric shock.
- Do not allow your phone to get wet—liquids can cause serious damage and will change the colour of the label that indicates water damage inside the phone. Do not handle your phone with wet hands. Water damage to your phone can void your manufacturer's warranty.
- Avoid using or storing your phone in dusty, dirty areas to prevent damage to moving parts.

- Your phone is a complex electronic device—protect it from impacts and rough handling to avoid serious damage.
- Do not paint your phone, as paint can clog moving parts and prevent proper operation.
- If your phone has a camera flash or light, avoid using it close to the eyes of children or animals.
- Your phone may be damaged by exposure to magnetic fields. Do not use carrying cases or accessories with magnetic closures or allow your phone to come in contact with magnetic fields for extended periods of time.

Avoid interference with other electronic devices

Your phone emits radio frequency (RF) signals that may interfere with unshielded or improperly shielded electronic equipment, such as pacemakers, hearing aids, medical devices, and other electronic devices in homes or vehicles. Consult the manufacturers of your electronic devices to solve any interference problems you experience.



Important usage information

Use your phone in the normal position

Avoid contact with your phone's internal antenna.

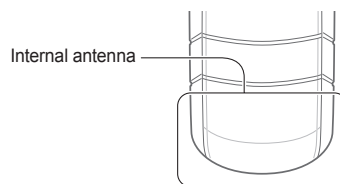

Allow only qualified personnel to service your phone

Allowing unqualified personnel to service your phone may result in damage to your phone and will void your warranty.

Ensure maximum battery and charger life

- Avoid charging batteries for more than a week, as overcharging may shorten battery life.
- Over time, unused batteries will discharge and must be recharged before use.
- Disconnect chargers from power sources when not in use.
- Use batteries only for their intended purpose.

Handle SIM cards or memory cards with care

- Do not remove a card while the phone is transferring or accessing information, as this could result in loss of data and/or damage to the card or phone.
- Protect cards from strong shocks, static electricity, and electrical noise from other devices.
- Do not touch gold-coloured contacts or terminals with your fingers or metal objects. If dirty, wipe the card with a soft cloth.

Ensure access to emergency services

Emergency calls from your phone may not be possible in some areas or circumstances. Before travelling in remote or undeveloped areas, plan an alternate method of contacting emergency services personnel.

Maintain your water and dust resistant feature

- Your phone is resistant to water and dust when all compartments are closed tightly. Your phone is not waterproof, so follow these tips carefully to prevent damage to your phone.
- Do not immerse the phone in water or use it in the rain.
- Do not expose the phone to salt water or ionised water, or to high water pressure.
- If the phone gets wet, dry it thoroughly with a clean soft cloth.
- Make sure that the multifunction jack cover is closed tightly.
- Always keep the multifunction jack cover clean and be careful to avoid damaging it.

Specific Absorption Rate (SAR) certification information

Your phone conforms to European Union (EU) standards that limit human exposure to radio frequency (RF) energy emitted by radio and telecommunications equipment. These standards prevent the sale of mobile phones that exceed a maximum exposure level (known as the Specific Absorption Rate, or SAR) of 2.0 W/kg. During testing, the maximum SAR recorded for this model was 0.408 W/kg. In normal use, the actual SAR is likely to be much lower, as the phone has been designed to emit only the RF energy necessary to transmit a signal to the nearest base station. By automatically emitting lower levels when possible, your phone reduces your overall exposure to RF energy. For more information about the SAR and related EU standards, visit the Samsung mobile phone website.

Correct disposal of this product

(Waste Electrical & Electronic Equipment)



(Applicable in the European Union and other European countries with separate collection systems)

This marking on the product, accessories or literature indicates that the product and its electronic accessories (e.g. charger, headset, USB cable) should not be disposed of with other household waste at the end of their working life.

To prevent possible harm to the environment or human health from uncontrolled waste disposal, please separate these items from other types of waste and recycle them responsibly to promote the sustainable reuse of material resources.

Household users should contact either the retailer where they purchased this product, or their local government office, for details of where and how they can take these items for environmentally safe recycling. Business users should contact their supplier and check the terms and conditions of the purchase contract. This product and its electronic accessories should not be mixed with other commercial wastes for disposal.

Correct disposal of batteries in this product



(Applicable in the European Union and other European countries with separate battery return systems)

This marking on the battery, manual or packaging indicates that the batteries in this product should not be disposed of with other household waste at the end of their working life. Where marked, the chemical symbols Hg, Cd or Pb indicate that the battery contains mercury, cadmium or lead above the reference levels in EC Directive 2006/66. If batteries are not properly disposed of, these substances can cause harm to human health or the environment.

To protect natural resources and to promote material reuse, please separate batteries from other types of waste and recycle them through your local, free battery return system.

Phone layout

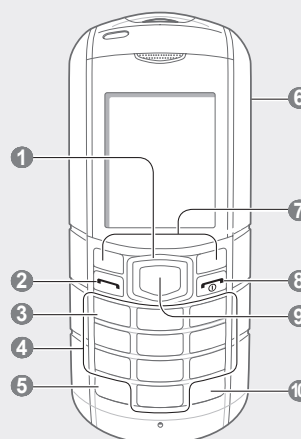

1

4-way navigation key

Scroll through menu options; In Idle mode, access user-defined menus and make a fake call (down)
▶ "Make fake calls"
Depending on your service provider, the default home screen or pre-defined menus may differ

2

Dial key

Make or answer a call; In Idle mode, retrieve recently dialed, missed, or received numbers; Send an SOS message
▶ "Activate and send an SOS message"

3

Voice mail service key

In Idle mode, access voice mails (press and hold)

4

Alphanumeric keys

5

Keypad lock key

In Idle mode, lock or unlock the keypad (press and hold)

6

Torch light key

In Idle mode, activate (press and hold) or deactivate the torch light
▶ "Activate the torch light"

7

Softkeys

Perform actions indicated at the bottom of the display

8

Power/Menu exit key

Turn the phone on and off (press and hold); End a call; In Menu mode, cancel input and return to Idle mode

9

Confirm key

Select the highlighted menu option or confirm an input; In Idle mode, access Menu mode; Launch the web browser (press and hold)
Depending on your service provider or region, the key may perform differently

10

Silent profile key

In Idle mode, activate or deactivate the silent profile (press and hold)

Your phone displays the following status indicators on the top of the screen:

Icon	Description	Icon	Description
	Signal strength		Alarm activated
	GPRS network connected		Memory card inserted
	Call in progress		New text message (SMS)
	Call diverting activated		New multimedia message (MMS)
	SOS message feature activated		New email message
	Roaming (outside of normal service area)		New voice mail message
	Connecting to secured web page		Normal profile activated
	FM radio on		Silent profile activated
	Bluetooth activated		Battery power level

Install the SIM card and battery

- Remove the battery cover and insert the SIM card.

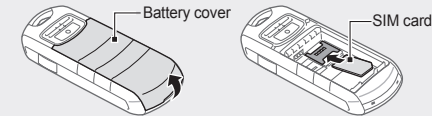

- Insert the battery and replace the battery cover.

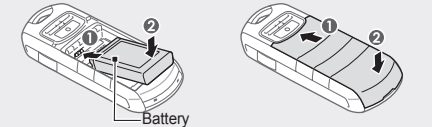

Charge the battery

- Plug the supplied travel adapter.
- When charging is finished, unplug the travel adapter.



-  Do not remove the battery from the phone before unplugging the travel adapter first. Otherwise, the phone may be damaged.
- When charging a dead battery, the indicator may not appear on the screen for the first 30 minutes.

Use the shortcut toolbar

You can use the shortcut toolbar to access your favourite menus.

To add menus on the shortcut toolbar

- In Menu mode, select **Settings** → **Display** → **Shortcuts toolbar**.
- Press **<Options>** → **Edit**.
- Select your favourite menus.
- Press **<Options>** → **Open** to select submenus (if necessary)
- Press **<Save>**, or press **<Options>** → **Save**.

To access a menu from the shortcut toolbar

In Idle mode, scroll left or right to the menu you want and press the Confirm key.

-  When the shortcut toolbar is activated, the Navigation key does not work as shortcuts depending on your region.

Change your ringtone

- In Menu mode, select **Settings** → **Profiles**.
- Scroll to the profile you are using.

-  If you are using the silent or offline profile, you are not allowed to change the ringtone.

Insert a memory card (optional)

Your phone accepts microSD™ memory cards up to 2 GB (depending on memory card manufacturer and type).

-  Formatting the memory card on a PC may cause incompatibility with your phone. Format the memory card only on the phone.
- Frequent writing and erasing of data will shorten the life span of memory cards.

- Remove the battery cover and battery.
- Unlock the memory card cover.

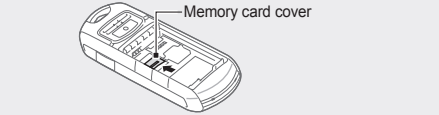

- Lift the memory card cover and insert a memory card with the label side facing up.

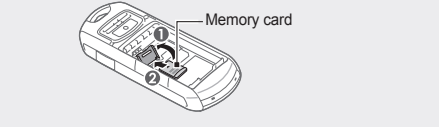

- Close and lock the memory card cover.
- Replace the battery and battery cover.

- Press **<Options>** → **Edit** → **Call ringtone**.
- Select a ringtone category → a ringtone.

To switch to another profile, select it from the list.

Call a recently dialed number

- In Idle mode, press [**↶**].
- Scroll left or right to a call type.
- Scroll up or down to select a number or name.
- Press the Confirm key to view details of the call or [**↶**] to dial the number.

Enter text

To change the text input mode

- Press [**#**] to change case or switch to Number mode.
- Press [*****] to switch to Symbol mode.
- Press and hold [*****] to select an input mode or change the input language.

T9 mode

- Press appropriate alphanumeric keys to enter an entire word.
- When the word displays correctly, press [0] to insert a space. If the correct word does not display, press the Navigation key up or down to select an alternate word.

-  By setting the options in Access remote phone, you can retrieve contacts, delete data on your lost phone, or receive calls to the phone or the phone's location information from the specified phone.
- To change the password for the mobile tracker, select **Change Mobile tracker 2.0 password**.

Use the camera

To capture photos

- In Menu mode, select **Camera** to turn on the camera.
- Aim the lens at the subject and make any adjustments.
- Press the Confirm key to take a photo. The photo is saved automatically.
- Press **<Back>** to take another photo (step 2).

After capturing photos, select **<Album>** to view photos.





To view photos

In Menu mode, select **My files** → **Images** → a photo file.

To capture videos

- In Menu mode, select **Camera** to turn on the camera.
- Press **<Options>** → **Camcorder** to switch to Recording mode.
- Aim the lens at the subject and make any adjustments.

Instructional icons

	Note: notes, usage tips, or additional information
	Followed by: the order of options or menu you must select to perform a step; for example: In Menu mode, select Messages → Create message (represents Messages , followed by Create message)
	Square brackets: phone keys; for example: [↶] (represents the Power/Menu exit key)
	Angled brackets: softkeys that control different functions at each screen; for example: <OK> (represents the OK softkey)

Turn your phone on or off

To turn your phone on,

- Press and hold [**↶**].
- Enter your PIN and press **<OK>** (if necessary).

To turn your phone off, repeat step 1 above.

-  If you remove the battery, the time and date will be reset.
- To transfer data from a PC to your phone, you need Windows XP Service Pack 2.

- Press [**ABC**].
- Press an alphanumeric key until the character you want appears on the display.

ABC mode

Press an appropriate alphanumeric key until the character you want appears on the display.

Number mode

Press an appropriate alphanumeric key to enter a number.

Symbol mode

Press an appropriate alphanumeric key to enter a symbol.

-  To move the cursor, press the Navigation key.
- To delete characters one by one, press **<Clear>**. To delete the characters on the left side of the cursor quickly, press and hold **<Clear>**.
- To insert a space between characters, press [0].
- To enter punctuation marks in English modes, press [1].

Add a new contact

-  The memory location to save new contacts may be preset depending on your service provider. To change the memory location, in Menu mode, select **Contacts** → **Management** → **Save new contact to**.

- In Idle mode, enter a phone number and press **<Options>**.
- Select **Create contact** → a memory location (if necessary).
- Select a number type (if necessary).

- Press the Confirm key to start recording.
- Press the Confirm key or **<Stop>** to stop recording. The video is saved automatically.

After capturing videos, select **<Album>** to view videos.

To view videos

In Menu mode, select **My files** → **Videos** → a video file.

Listen to music

- In Menu mode, select **Music**.
- Select a music category → a music file.
- Control playback using the following keys:

Key	Function
Confirm	Pause or resume playback
Navigation	<ul style="list-style-type: none">Left: Skip backward; Scan backward in a file (press and hold) Right: Skip forward; Scan forward in a file (press and hold) Up/Down: Adjust the volume

Access menus

To access your phone's menus,

- In Idle mode, press **<Menu>** to access Menu mode.

-  You may need to press the Confirm key to access Menu mode depending on your region or service provider.

- Use the Navigation key to scroll to a menu or option.
- Press **<Select>**, **<OK>**, or the Confirm key to confirm the highlighted option.
- Press **<Back>** to move up one level; Press [**↶**] to return to Idle mode.

-  When you access a menu requiring the PIN2, you must enter the PIN2 supplied with the SIM card. For details, contact your service provider.
- Samsung is not responsible for any loss of passwords or private information or other damages caused by illegal software.

Make a call

- In Idle mode, enter an area code and a phone number.
- Press [**↶**] to dial the number.
- To end the call, press [**↶**].

- Enter contact information.
- Press the Confirm key to add the contact to memory.

Send and view messages

To send a text or multimedia message

- In Menu mode, select **Messages** → **Create message** → **Message**.
- Enter a recipient number and scroll down.
- Enter your message text. ► *Enter text* For sending as a text message, skip to step 5. For attaching multimedia, continue with step 4.
- Press **<Options>** → **Add multimedia** and add an item.
- Press the Confirm key to send the message.

To view text or multimedia messages

- In Menu mode, select **Messages** → **Inbox**.
- Select a text or multimedia message.

Make fake calls

You can simulate an incoming call when you want to get out of meetings or unwanted conversations.

- In Idle mode, press and hold the Navigation key down.

- When the keys are locked, press the Navigation key down four times.

Listen to the FM radio

- Plug the supplied headset into the phone.
- In Menu mode, select **Applications** → **FM radio**.
- Press the Confirm key to start the FM radio.
- Press **<Yes>** to start automatic tuning. The radio scans and saves available stations automatically.

-  The first time you turn on the FM radio, you will be prompted to start automatic tuning.

- Control the FM radio using the following keys:

Key	Function
Confirm	Turn the FM radio on or off
Navigation	<ul style="list-style-type: none">Left/Right: Tune a radio station Up/Down: Adjust the volume

- To turn off the FM radio, press the Confirm key.

Answer a call

- When a call comes in, press [**↶**].
- To end the call, press [**↶**].

Adjust the volume

To adjust the volume of the ringtone

- In Menu mode, select **Settings** → **Profiles**.
- Scroll to the profile you are using.

-  If you are using the silent profile, you are not allowed to adjust the volume of the ringtone.

- Press **<Options>** → **Edit** → **Volume** → **Call alert**.
- Scroll left or right to adjust the volume level.
- Press **<Save>**.

To adjust the volume of voice during a call

While a call is in progress, press the Navigation key up or down to adjust the volume.

-  In noisy environments, you may have difficulty hearing the calls while using the speakerphone feature. For better audio performance, use the normal phone mode.

- Press [**ABC**].
- Press an alphanumeric key until the character you want appears on the display.

Activate and send an SOS message

In an emergency, you can send SOS messages to your family or friends for help.

To activate the SOS message

- In Menu mode, select **Messages** → **Settings** → **SOS messages** → **Sending options**.
- Scroll left or right to **On**.
- Scroll down and press the Confirm key to open the recipient list.
- Press the Confirm key to open your contact list.
- Select a contact.
- Select a number (if necessary).
- Press **<Options>** → **Save** to save the recipients.
- Scroll down and set the number of times to repeat the SOS message.
- Press **<Save>** → **<Yes>**.

To send an SOS message

- With the keys locked, press [**↶**] four times to send an SOS message to preset numbers. The phone switches to SOS mode and sends the preset SOS message.
- To exit SOS mode, press [**↶**].

Activate the torch light

The torch light feature helps you see in dark places by turning the flashlight on. To activate the torch light, in Idle mode, press and hold [**↵**].

To deactivate the torch light, in Idle mode, press [**↵**].

Use the mobile prayer feature

The mobile prayer feature alerts you to prayer time using the specified alarm tone and wallpaper. You can set different alarms for each day.

In Menu mode, press <Menu> → **Applications** → **Mobile prayer** to set mobile prayer alarms.