

USB HD Audio/Video KVM Switch

USER MANUAL

CS692

EMC INFORMATION

FEDERAL COMMUNICATIONS COMMISSION INTERFERENCE

STATEMENT: This equipment has been tested and found to comply with the limits for a Class A digital device, pursuant to Part 15 of the FCC Rules. These limits are designed to provide reasonable protection against harmful interference when the equipment is operated in a commercial environment. This equipment generates, uses, and can radiate radio frequency energy and, if not installed and used in accordance with the instruction manual, may cause harmful interference to radio communications. Operation of this equipment in a residential area is likely to cause harmful interference in which case the user will be required to correct the interference at his own expense.

The device complies with Part 15 of the FCC Rules. Operation is subject to the following two conditions: (1) this device may not cause harmful interference, and (2) this device must accept any interference received, including interference that may cause undesired operation.

FCC Caution: Any changes or modifications not expressly approved by the party responsible for compliance could void the user's authority to operate this equipment.

CE Warning: This is a class A product. In a domestic environment this product may cause radio interference in which case the user may be required to take adequate measures.

This device complies with Part 15 of the FCC Rules. Operation is subject to the following two conditions: (1) this device may not cause harmful interference, and (2) this device must accept any interference received, including interference that may cause undesired operation.

RoHS

This product is RoHS compliant.

SJ/T 11364-2006

The following contains information that relates to China.

部件名称	有毒有害物质或元素					
	铅	汞	镉	六价铬	多溴联苯	多溴二苯醚
电器部件	●	○	○	○	○	○
机构部件	○	○	○	○	○	○

○: 表示该有毒有害物质在该部件所有均质材料中的含量均在SJ/T 11363-2006规定的限量要求之下。

●: 表示符合欧盟的豁免条款, 但该有毒有害物质至少在该部件的某一均质材料中的含量超出SJ/T 11363-2006的限量要求。

×: 表示该有毒有害物质至少在该部件的某一均质材料中的含量超出SJ/T 11363-2006的限量要求。



CS692 USER MANUAL

Online Registration

International	http://eservice.aten.com
---------------	---

Telephone Support

International	886-2-8692-6959
China	86-10-5255-0110
Japan	81-3-5323-7178
Korea	82-2-467-6789
North America	1-888-999-ATEN ext 4988
United Kingdom	44-8448-158923

Technical Support

- ◆ For international online technical support – including troubleshooting, documentation, and software updates:
<http://eservice.aten.com>
- ◆ For North American technical support:

Email Support		support@aten-usa.com
Online Technical Support	Troubleshooting Documentation Software Updates	http://www.aten-usa.com/support
Telephone Support		1-888-999-ATEN ext 4998

PACKAGE CONTENTS

The CS692 USB HD Audio/Video KVM Switch package contains the following items:

- ◆ 1 CS692 USB HD Audio/Video KVM Switch with Remote Port Selector
- ◆ 2 Hotkey Stickers
- ◆ 1 User Manual*
- ◆ 1 Quick Start Guide

Check to make sure that all the components are present and that nothing got damaged in shipping. If you encounter a problem, contact your dealer.

Read this manual thoroughly and follow the installation and operation procedures carefully to prevent any damage to the unit, and/or any of the devices connected to it.

* Features may have been added to the CS692 since this manual was printed. Please visit our website to download the most up-to-date version of the manual.

Copyright © 2010–2014 ATEN® International Co., Ltd.
Manual Date: 2014-10-29 - Manual Part No. PAPE-1349-AT3G



ATEN and the ATEN logo are trademarks of ATEN International Co., Ltd. All rights reserved. All other trademarks are the property of their respective owners.

OVERVIEW

The CS692 USB HD Audio/Video KVM Switch links two HD audio/video-enabled PCs or devices to a single USB keyboard, USB mouse, and HD audio/video display console. The CS692 Switch takes a giant step forward from prior cable KVM models in the Petite series, by offering full HD audio/video functionality, USB 2.0 peripheral sharing (via a USB hub attached to the USB mouse port), and a firmware upgrade function that allows you to keep up with latest available versions.

Another new feature of the CS692 is the implementation of a remote port selector. This means that you can now control port switching from the desktop while the switch itself can be placed in a convenient, out-of-the-way, location. Also, in addition to new hotkeys, the CS692 offers the latest mouse port-switching function – simply double-click on the scroll wheel of a USB mouse to change ports.

Furthermore, the CS692 features ATEN's patented Video DynaSync technology, which eliminates boot-up display problems and optimizes resolution when switching between ports.

Finally, the CS692's new Power on detection feature means that if one of the computers is powered off, switch will automatically switch to the other powered-on computer.

Featuring an unbeatable combination of HD audio/video functionality, USB 2.0 peripheral sharing convenience, gaming keyboard support, and enhanced user-friendly operations, the CS692 allows users to keep up with the latest innovations in desktop multimedia applications.

FEATURES

- ◆ One HD audio/video console controls two USB computers
- ◆ Computer selection via remote port selector, hotkeys, and USB mouse
- ◆ Audio-enabled – full bass response provides a rich experience for 2.1 channel surround sound systems
- ◆ Independent switching of the KVM and Audio focus – one computer has the KVM focus and the other the Audio focus*
- ◆ Multiplatform support – Windows 2000 / XP / Vista / 7, Mac, Linux
- ◆ Compact design, built-in all-in-one cables (2 x 1.2 m)
- ◆ Superior video quality – up to 1920 x 1200
- ◆ Compatible with widescreen LCD monitors
- ◆ Video DynaSync – exclusive ATEN technology eliminates boot-up display problems and optimizes resolution when switching between ports
- ◆ Power on detection – if one computer is powered off, the CS692 will automatically switch to the other computer
- ◆ Supports gaming and multimedia keyboards
- ◆ Supports multifunction and wireless keyboards and mice
- ◆ Console mouse port emulation/bypass feature supports most mouse drivers and multifunction mice
- ◆ Mac keyboard support and emulation**
- ◆ USB 2.0 mouse port can be used for USB hub and USB peripheral sharing***
- ◆ Non-Powered
- ◆ Firmware upgradable

-
- Note:**
1. HD audio through the monitor's built-in speakers cannot be switched independently.
 2. PC keyboard combinations emulate Mac keyboards. Mac keyboards work only with their own computers.
 3. May require an additional power adapter.
 4. To use the USB 2.0 mouse port as a USB hub, you must first disable mouse emulation mode. See *Hotkey Summary Table*, page 15 for information.
-

SYSTEM REQUIREMENTS

CONSOLE

- ◆ An HD audio/video monitor
- ◆ A USB keyboard and a USB mouse
- ◆ Speakers and microphone (optional)

COMPUTERS

The following equipment must be installed on each computer that is to be connected to the system:

- ◆ An HD audio/video port
- ◆ USB Type A port
- ◆ Speaker and microphone ports (optional)

CABLES

The CS692's innovative design features built-in KVM and audio cables for extra convenience. No further cables are necessary.

OPERATING SYSTEMS

Supported operating systems are shown in the table, below:

OS		Version
Windows		2000 / XP / 2003 / 2008 / Vista / 7
Linux	RedHat	9.0, Fedora and higher
	SuSE	10 / 11.1 and higher
	Debian	3.1 / 4.0
	Ubuntu	7.04 / 7.10
UNIX	FreeBSD	5.5 / 6.1 / 6.2
Novell	Netware	6.0 / 6.5
Mac		OS 9 and higher
DOS		6.2 and higher

COMPONENTS

CS692

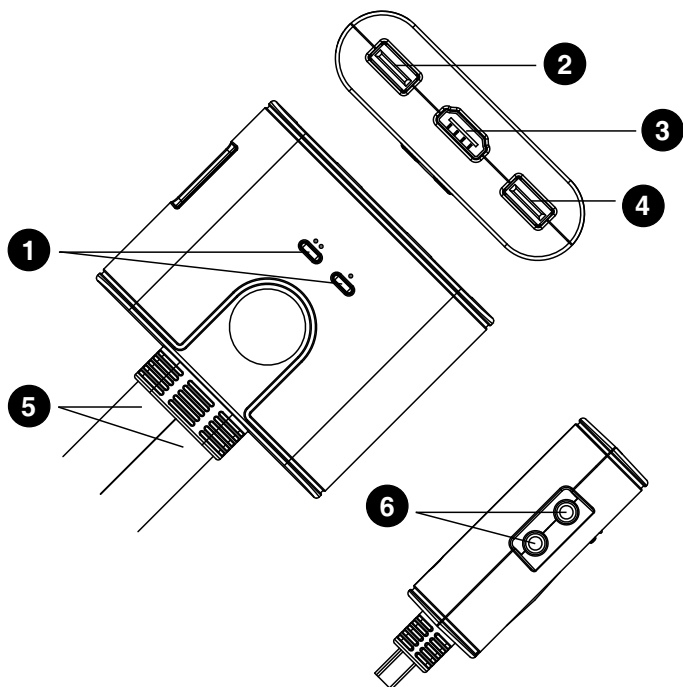

REMOTE PORT SELECTOR

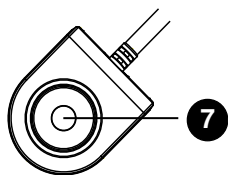

No.	Component	Description
1	Port LEDs	<p>The LED lights on to indicate that the computer attached to its corresponding port is selected and has the KVM focus.</p> <p>The LED flashes to indicate that the computer attached to its corresponding port is being scanned by the Auto Scan function.</p> <p>The LED is off to indicate the port is not selected.</p>
2	Console Keyboard Port	Your USB console keyboard plugs in here.
3	Console Monitor Port	Your HD audio/video console monitor plugs in here.
4	Console Mouse Port	Your USB console mouse plugs in here.
5	KVM Cables	The connectors at the end of these built-in KVM cables attach to the two HD audio/video computers/devices in your CS692 installation. See the diagram on page 12 for further details.
6	Console Audio Ports	Your console speakers* and microphone plug in here.
7	Port Selection Pushbutton	Press the Port Selection Pushbutton to toggle the KVM and Audio focus between the two computers/devices.

* If your console monitor has built-in speakers and supports audio through its HD audio/video interface, separate speakers are not needed.

INSTALLATION



1. Make sure that the power to any device that you connect to the installation has been turned off. You must unplug the power cords of any computers that have the *Keyboard Power On* function.
2. Make sure that all devices you will be installing are properly grounded.

1. Plug your keyboard and mouse into their USB ports, located on the front of the CS692. The ports are color coded and labeled with an appropriate icon.

Note: The mouse connector is actually a USB 2.0 port, and can accept any USB compatible peripheral. You can even connect a hub to install multiple USB devices (This may require an extra power adapter).

2. Plug your monitor into the HD audio/video port, located on the front of the CS692. Power on the monitor.
3. Plug your speakers and microphone into the console audio ports, located on the front of the CS692 (Optional).

Note: If your console monitor has built-in speakers and supports audio through its HD audio/video interface, separate speakers are not needed.

4. Plug the USB, HD audio/video, and audio connectors of the KVM cables into their respective ports on the computers you are installing.
5. Power on the computers.

Note: By default the switch links to the first computer that is powered on.

INSTALLATION DIAGRAM

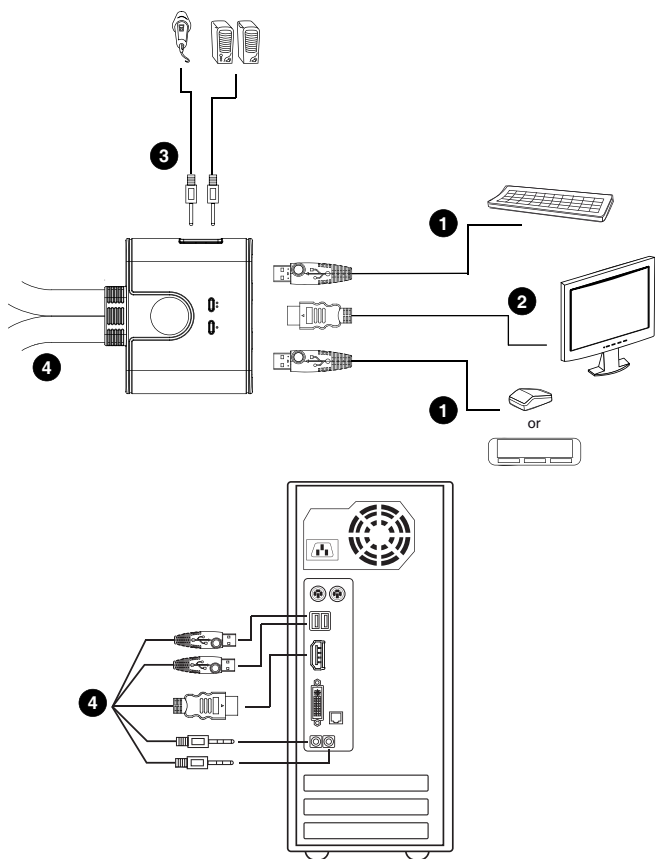

OPERATION

The CS692 provides three convenient methods of selecting computers: Manual – click the pushbutton on the Remote Port Selector; Mouse – click the mouse's scroll wheel; and Hotkey – enter combinations from the keyboard.

MANUAL PORT SELECTION

Press the port selection pushbutton on the Remote Port Selector to toggle the KVM and Audio focus between the two computers. The Port LED lights to indicate that the computer attached to its corresponding port has the focus.

Note: Do not switch ports while a USB device is in operation. For independent USB switching, please see the USB KVMP switches on our website.

MOUSE PORT SELECTION

Simply double-click the scroll wheel on your USB mouse to switch between ports. The mouse port-switching function allows you to toggle back and forth between the ports.

Note:

1. This feature is only supported by USB 3-key scroll wheel mice.
2. The default setting is OFF.
3. This feature is only supported when mouse emulation is enabled. See *Hotkey Summary Table*, page 15 for further details.

HOTKEY PORT SELECTION

All hotkey operations begin by tapping the **Scroll Lock** key twice. See the *Hotkey Summary Table* for full details.

Note: If using [Scroll Lock] conflicts with other programs, [Ctrl] can be used instead.

Alternate Entering Hotkey Mode

- ◆ Press [Scroll Lock] [Scroll Lock] [x] [Enter]. The entering hotkey mode hotkey is now [Ctrl].

or









- ◆ Press and hold the remote port selector switch for three seconds. The entering hotkey mode hotkey is now [Ctrl].

Note: These procedures toggle between the two methods.

HOTKEY SUMMARY TABLE

Combination	Function
[Scroll Lock] [Scroll Lock] +	Toggles the KVM and Audio focus between the two ports. Note: If the KVM and Audio focus are on different ports, only the KVM focus switches.
[k] [Enter]	Toggles the KVM focus only.
[s] [Enter]	Toggles the Audio focus only.
[a] [Enter]	Starts Auto Scan. The KVM focus cycles from port to port at 5 second intervals.
[a] [Enter] [n]	Starts Auto Scan. The KVM focus cycles from port to port at n second intervals. Note: Replace n with a number between 1 and 4 (1 = 3 secs; 2 = 5 secs (default); 3 = 10 secs; 4 = 20 secs). To exit Auto Scan, press [Esc] or [Spacebar]. Auto Scanning stops when you exit Auto Scan mode.
[x] [Enter]	Toggles the hotkey invocation key between [Scroll Lock] and [Ctrl].
[m] [Enter]	Enables/disables mouse emulation function.
[n] [Enter]	Enables/disables keyboard emulation.
[w] [Enter]	Enables/disables mouse port-switching function.
[F2] [Enter]	Activates Mac keyboard mapping.
[F10] [Enter]	Automatically detects and sets the keyboard operating platform.
[F4] [Enter]	Lists current switch settings.
[F5] [Enter]	Performs a USB keyboard and mouse reset.
[F6] [nn] [Enter]	Sets the keyboard language layout. Note: nn is a two digit number that represents one of the following keyboard language codes: US English 33; French 08; Japanese 15
[d] [Enter]	Invokes the Video DynaSync function, which eliminates boot-up display problems and optimizes resolution when switching between ports.
[e] [Enter]	Enables/Disables the Power on Detection feature.
[r] [Enter]	Resets hotkeys to the default setting.

KEYBOARD EMULATION

PC Keyboard	Mac Keyboard
[Shift]	Shift
[Ctrl]	Ctrl
	
[Ctrl] [1]	
[Ctrl] [2]	
[Ctrl] [3]	
[Ctrl] [4]	
[Alt]	Alt
[Print Screen]	F13
[Scroll Lock]	F14
	=
[Enter]	Return
[Backspace]	Delete
[Insert]	Help
[Ctrl] 	F15

Note: When using key combinations, press and release the first key (Ctrl), then press and release the activation key.

THE FIRMWARE UPGRADE UTILITY

To upgrade the CS692's firmware, do the following:

1. From a computer that is not part of your KVM installation, download the latest Firmware Upgrade package for the CS692 from our Internet support site (www.aten.com).
2. Disconnect the CS692 from your KVM installation. Press and hold the Remote Port Selector's pushbutton. While you are still holding the pushbutton, connect the KVM cable's purple USB connector to a USB port on the computer you have downloaded the Firmware Upgrade package to.
3. The CS692 now enters Firmware Upgrade Mode. The two Ports LEDs flash together to indicate that the unit is in Firmware Upgrade Mode.

Note: While the CS692 is in Firmware Upgrade Mode, normal keyboard and mouse functions are suspended. You must complete the firmware upgrade or exit Firmware Upgrade Mode to regain normal control of the console.

4. Run the Firmware Upgrade Package file. The *Firmware Upgrade Utility Welcome* screen appears.
5. Read the License Agreement and enable to *I Agree* button.
6. Click **Next** to continue. The Firmware Upgrade Utility main screen appears. All the devices capable of being upgraded by the package are listed in the *Devices List* panel.
7. Select your device. Its description appears in the Device Description panel. Click **Next** to perform the upgrade.
As the upgrade proceeds, status messages appear in the Status Messages panel, and the progress towards completion is shown in the *Progress* bar.
8. After the upgrade has completed, a screen appears to inform you that procedure was successful. Click **Finish** to close the Firmware Upgrade Utility.
9. Set up your KVM installation again. See *Installation*, page 11.

UPGRADE FAILED

If the Upgrade Succeeded screen doesn't appear, it means that the upgrade failed to complete successfully, in which case you should do the following:

1. Disconnect the USB connectors on the KVM cables from the computer.
2. Press and hold the Remote Port Selector's pushbutton. While you are still holding the pushbutton, reconnect the KVM cable's USB connectors to the computer.
3. Power on the CS692. It will now work with the factory default firmware. Follow steps 3 to 9 on page 17 again.

TROUBLESHOOTING

Symptom	Possible Cause	Action
Monitor does not display after the KVM cable set is hot-plugged.	HD audio/video graphics card is not compatible with cable set hot-plugging.	Power off all devices on the installation; power off the CS692; confirm all KVM cables are properly connected; power on the CS692; power on the computers.
	Graphics card driver is not up-to-date.	Upgrade to the latest graphics card driver.
Mouse and/or keyboard is not responding.	Switch needs to be reset.	Power off all devices on the installation; power off the CS692; wait five seconds; power on the CS692 again.
Mouse port-switching function is not responding.	Mouse does not support this function.	This feature is only supported by USB 3-key scroll wheel mice.
	Mouse emulation is disabled.	Enable mouse emulation. See <i>Hotkey Summary Table</i> , page 15, for details.
Cannot switch ports by pressing [Scroll Lock] twice.	Keyboard is incompatible with [Scroll Lock] invocation.	Switch to the alternate HSM invocation keys. See <i>Alternate Entering Hotkey Mode</i> , page 14, for details.

SPECIFICATIONS

Function		CS692	
Computer Connections		2	
Console Connections		1	
Port Selection		Remote Port Selector, Mouse, Hotkeys	
Connectors	Console Ports	Keyboard	1 x USB Type A Female (Silver)
		Video	1 x HD audio/video Type A Female (White)
		Mouse	1 x USB Type A Female (Silver)
		Speakers	1 x Mini Stereo Jack Female (Green)
		Mic.	1 x Mini Stereo Jack Female (Pink)
	KVM Ports	Keyboard	2 x USB Type A Male (Purple)
		Video	2 x HD audio/video Type A Male (Black)
		Mouse	2 x USB Type A Male (Black)
		Speakers	2 x Mini Stereo Plug Male (Green)
		Mic.	2 x Mini Stereo Plug Male (Pink)
LEDs	KVM	2 (Green)	
Cable Length	KVM	2 x 1.2 m	
	Remote Port Selector	1.8 m	
Emulation	Keyboard / Mouse	USB	
Video		1080p; 1920 x 1200	
Scan Interval		3, 5, 10, 20 secs. (default 5 secs.)	
Power Consumption		DC 5 V, 2.65 W	
Environment	Operating Temp.	0–50°C	
	Storage Temp.	-20–60°C	
	Humidity	0–80% RH, Non-condensing	
Physical Properties	Housing	Plastic	
	Weight	0.41 kg	
	Dimensions (L x W x H)	6.70 x 8.20 x 2.65 cm	

FACTORY DEFAULT HOTKEY SETTINGS

Setting	Default
Port Switching Hotkey	[Scroll Lock] [Scroll Lock]
Invoking HSM	[Scroll Lock] [Scroll Lock]
Auto Scan Interval	5 seconds
Keyboard Operating Platform	PC Compatible
Mouse Emulation	Enabled
Keyboard Emulation	Enabled
Mouse Port-Switching	Disabled
Power on Detection	Enabled

LIMITED WARRANTY

IN NO EVENT SHALL THE DIRECT VENDOR'S LIABILITY EXCEED THE PRICE PAID FOR THE PRODUCT FROM THE DIRECT, INDIRECT, SPECIAL, INCIDENTAL OR CONSEQUENTIAL DAMAGES RESULTING FROM THE USE OF THE PRODUCT, DISK OR ITS DOCUMENTATION.

The direct vendor makes no warranty or representation, expressed, implied, or statutory with respect to the contents or use of this documentation, and specially disclaims its quality, performance, merchantability, or fitness for any particular purpose.

The direct vendor also reserves the right to revise or update the device or documentation without obligation to notify any individual or entity of such revisions, or update. For further inquires please contact your direct vendor.