

KVM On the NET™
CS1708i / CS1716i
User Manual



FCC Information

This is an FCC Class A product. In a domestic environment this product may cause radio interference in which case the user may be required to take adequate measures.

This equipment has been tested and found to comply with the limits for a Class A digital device, pursuant to Part 15 of the FCC Rules. These limits are designed to provide reasonable protection against harmful interference when the equipment is operated in a commercial environment. This equipment generates, uses and can radiate radio frequency energy and, if not installed and used in accordance with the instruction manual, may cause harmful interference to radio communications. Operation of this equipment in a residential area is likely to cause harmful interference in which case the user will be required to correct the interference at his own expense.

RoHS

This product is RoHS compliant.

SJ/T 11364-2006

The following contains information that relates to China.

部件名称	有毒有害物质或元素					
	铅	汞	镉	六价铬	多溴联苯	多溴二苯醚
电器部件	●	○	○	○	○	○
机构部件	○	○	○	○	○	○

- : 表示该有毒有害物质在该部件所有均质材料中的含量均在SJ/T 11363-2006规定的限量要求之下。
- : 表示符合欧盟的豁免条款, 但该有毒有害物质至少在该部件的某一均质材料中的含量超出SJ/T 11363-2006的限量要求。
- ×: 表示该有毒有害物质至少在该部件的某一均质材料中的含量超出SJ/T 11363-2006的限量要求。



User Information

Online Registration

Be sure to register your product at our online support center:

International	http://support.aten.com
North America	http://www.aten-usa.com/product_registration

Telephone Support

For telephone support, call this number:

International	886-2-8692-6959
China	86-10-5255-0110
Japan	81-3-5615-5811
Korea	82-2-467-6789
North America	1-888-999-ATEN ext 4988
United Kingdom	44-8-4481-58923

User Notice

All information, documentation, and specifications contained in this manual are subject to change without prior notification by the manufacturer. The manufacturer makes no representations or warranties, either expressed or implied, with respect to the contents hereof and specifically disclaims any warranties as to merchantability or fitness for any particular purpose. Any of the manufacturer's software described in this manual is sold or licensed *as is*. Should the programs prove defective following their purchase, the buyer (and not the manufacturer, its distributor, or its dealer), assumes the entire cost of all necessary servicing, repair and any incidental or consequential damages resulting from any defect in the software.

The manufacturer of this system is not responsible for any radio and/or TV interference caused by unauthorized modifications to this device. It is the responsibility of the user to correct such interference.

The manufacturer is not responsible for any damage incurred in the operation of this system if the correct operational voltage setting was not selected prior to operation. **PLEASE VERIFY THAT THE VOLTAGE SETTING IS CORRECT BEFORE USE.**

Package Contents

The CS1708i / CS1716i package consists of:

- ◆ 1 CS1708i / CS1716i KVM Switch
- ◆ 2 Custom KVM Cable Sets (1 x PS/2; 1 x USB)
- ◆ 1 Console Cable
- ◆ 1 Firmware Upgrade Cable
- ◆ 1 Mounting Kit
- ◆ 1 Foot Pad Set (4 pcs)
- ◆ 1 Power Adapter
- ◆ 1 User Instructions*
- ◆ 1 Software CD

Check to make sure that all the components are present and that nothing got damaged in shipping. If you encounter a problem, contact your dealer.

Read this manual thoroughly and follow the installation and operation procedures carefully to prevent any damage to the unit, and/or any of the devices connected to it.

* Features may have been added to the CS1708i / CS1716i since this manual was published. Please visit our website to download the most up-to-date version of the manual.

© Copyright 2009–2013 ATEN® International Co., Ltd.
Manual Part No. PAPE-0317-AT5G
F/W Version: 1.3.127
Manual Date: 2013-05-22

ATEN and the ATEN logo are registered trademarks of ATEN International Co., Ltd. All rights reserved.

Contents

FCC Information	ii
RoHS	ii
SJ/T 11364-2006	ii
User Information	iii
Online Registration	iii
Telephone Support	iii
User Notice	iii
Package Contents	iv
About this Manual	xi
Overview	xi
Terminology	xii
Conventions	xiii
Product Information	xiii
1. Introduction	
Overview	1
Features	3
Requirements	5
General	5
Console	5
Computers	5
Cables	6
Operating Systems	6
Browsers	7
Components	8
Front Panel	8
CS1708i	8
CS1716i	8
Rear Panel	10
CS1708i	10
CS1716i	10
2. Hardware Setup	
Overview	13
Before You Begin	13
Stacking and Rack Mounting	14
Stacking	14
Rack Mounting – Front	15
Rack Mounting – Rear	17
Single Station Installation	19
Cable Connection Diagrams	20
Daisy Chaining	21
Powering Up	21

3. Basic Operation

Port Selection	23
Manual	23
OSD/GUI	23
Keyboard Hotkeys	23
Hot Plugging	24
Hot Plugging Stations	24
Hot Plugging KVM Ports	24
Hot Plugging Console Ports	24
Port ID Numbering	25
Powering Off and Restarting	25
USB Peripheral Devices	26

4. Local Console Operation

Overview	27
OSD Main Screen	28
OSD Navigation	29
OSD Main Screen Headings	29
OSD Functions	30
F1: GOTO	30
F2: LIST	31
F3: SET	32
F4: ADM	34
F5: SKP	36
F6: BRC	37
F7: SCAN	38
F8: LOUT	39
Hotkey Operation	40
Overview	40
Invoking Hotkey Mode	41
Hotkey Port Control	42
Hotkey Configuration Operations	45
Hotkey Beeper Control	45
Toggling the Hotkey Invocation Keys	45
Setting the Port Operating System	46
Restore Default Values	46
Hotkey Summary Table	47

5. Browser Login

Overview	49
Logging In	49
Main Webpage Elements	52
User Access Icons	52
Administrative Function Icons	52

6. Administration

Introduction	53
General Information	54
Network	55
Access Ports	55
IPv4 Configuration	56
DNS Server	56
IPv6 Configuration	57
DNS Server	57
IP Installer Settings	58
Finishing Up	58
Security	59
IP Filter / MAC Filter Conflict	61
Modifying Filters	61
Deleting Filters	61
Login String	61
ANMS	62
RADIUS Settings	63
RADIUS Examples	64
CC Management Settings	64
LDAP Settings	64
Log Server	66
User Management	67
Customization	69
Timeout	69
Login Failure	69
Working Mode	70
Mouse Sync Mode	70
Reset	71
Maintenance	72
Firmware Upgrade	72
Backup Configuration / User Accounts / Port Names	73
Restore Configuration / User Accounts / Port Names	74

7. The Windows Client Viewer

Starting Up	75
The Control Panel	77
Hotkey Setup	79
Configuring the Hotkeys	80
Video Settings	81
The Message Board	82
Message Display Panel	83
Compose Panel	83
User List Panel	83
The On-Screen Keyboard	84
Changing Languages	84

The Main Page	85
The List Function.	86
Port Names	88
Port Operation	90
The Port Toolbar.	90
Recalling the GUI	90
Hotkey Summary Table.	91
Toolbar Icons	91
Auto Scan Mode	92
Panel Array Mode	93
The Configuration Page	95
The Administration Page	97
General Information	97
User Management.	98
Network.	101
ANMS	102
Security	103
Customization	104
8. The Java Client Viewer	
Starting Up	107
Operation	109
9. The Log File	
The Log File Screen	111
10. The Log Server	
Installation.	113
Starting Up	114
The Menu Bar.	115
Configure.	115
Events	116
Maintenance	117
Options	118
Help	118
The Log Server Main Screen	119
Overview	119
The List Panel	120
The Tick Panel	120
11. AP Operation	
Overview	121
The Windows Client	121
Installation.	121
Starting Up	122
Connecting	124
Operation	125

Ending the Session	125
The Java Client	126
Starting Up	126
Operation	127
12. The Firmware Upgrade Utility	
Introduction	129
Downloading the Firmware Upgrade Package	129
Preparation	130
Starting the Upgrade	131
Upgrade Succeeded	133
Upgrade Failed	133
Firmware Upgrade Recovery	134
Appendix	
Safety Instructions	135
General	135
Rack Mounting	137
Technical Support	138
International	138
North America	138
Troubleshooting	139
Administration	139
General Operation	139
The Windows Client	140
The Java Client	140
Sun Systems	141
The Log Server	142
Panel Array Mode	142
Keyboard Emulation	143
Mac Keyboard	143
Sun Keyboard	144
IP Address Determination	145
IP Installer	145
Browser	146
AP Windows Client	146
IPv6	147
Link Local IPv6 Address	147
IPv6 Stateless Autoconfiguration	148
Additional Mouse Synchronization Procedures	149
Trusted Certificates	151
Overview	151
Installing the Certificate	152
Certificate Trusted	153
Specifications	154
Connection Tables	155
CS1708i	155

CS1716i	155
Supported KVM Switches	156
Restoring Factory Default Settings	157
OSD Factory Default Settings	158
About SPHD Connectors	158
Limited Warranty	158

About this Manual

This user manual is provided to help you get the most from your CS1708i / CS1716i system. It covers all aspects of installation, configuration and operation. An overview of the information found in the manual is provided below.

Overview

Chapter 1, Introduction, introduces you to the CS1708i / CS1716i system. Its purpose, features and benefits are presented, and its front and back panel components are described.

Chapter 2, Hardware Setup, describes how to set up your installation. The necessary steps – from a basic single stage hookup to a complete 32-switch daisy chained operation are provided.

Chapter 3, Basic Operation, explains the fundamental concepts involved in operating the CS1708i / CS1716i.

Chapter 4, Local Console Operation, describes the concepts and procedures used to operate the CS1708i / CS1716i from a locally connected KVM console.

Chapter 5, Browser Login, explains how to log into the CS1708i / CS1716i with your browser, and explains the functions of the icons and buttons on the CS1708i / CS1716i web page.

Chapter 6, Administration, describes how to administer the CS1708i / CS1716i after logging in from a browser.

Chapter 7, The Windows Client Viewer, explains how to connect to the CS1708i / CS1716i with the Windows Client Viewer, and describes how to use the GUI to access and control the computers connected to the switch.

Chapter 8, The Java Client Viewer, describes how to connect to the CS1708i / CS1716i with the Java Client Viewer, and explains how to use the GUI to access and control the computers connected to the switch.

Chapter 9, The Log File, shows how to use the log file utility to view all the events that take place on the CS1708i / CS1716i.

Chapter 10, The Log Server, explains how to install and configure the Log Server.

Chapter 11, AP Operation, describes how to operate the CS1708i / CS1716i using Windows and Java Client application programs, rather than with the browser method.

Chapter 12, The Firmware Upgrade Utility, explains how to use this utility to upgrade the CS1708i / CS1716i's firmware with the latest available versions.

An Appendix, provides specifications and other technical information regarding the CS1708i / CS1716i.

Terminology

Throughout the manual we make reference to the terms *Local* and *Remote* in regard to the operators and equipment deployed in a KVM On the NET™ switch installation. Depending on the point of view, users and servers can be considered *Local* under some circumstances, and *Remote* under others:

- ◆ Switch's Point of View
 - ◆ Remote users – We refer to a user as a *Remote* user when we think of him as someone who logs into the switch over the net from a location that is *remote from the switch*.
 - ◆ Local Console – The keyboard mouse and monitor connected directly to the switch.
 - ◆ Servers – The servers attached to the switch via KVM Adapter Cables.
- ◆ User's Point of View
 - ◆ Local client users – We refer to a user as a *Local client user* when we think of him as sitting at his computer performing operations on the servers connected to the switch that are *remote from him*.
 - ◆ Remote servers – We refer to the servers as *Remote servers* when we think of them from the Local Client User's point of view – since, although they are locally attached to the switch, they are *remote from him*.

When we describe the overall system architecture we are usually speaking from the switch's point of view – in which case the users are considered remote. When we speak about operations users perform via the browser, viewers, and AP programs over the net, we are usually speaking from the user's point of view – in which case the switch and the servers connected to it are considered remote.

Conventions

This manual uses the following conventions:

- Monospaced Indicates text that you should key in.
- [] Indicates keys you should press. For example, [Enter] means to press the **Enter** key. If keys need to be chorded, they appear together in the same bracket with a plus sign between them: [Ctrl+Alt].
1. Numbered lists represent procedures with sequential steps.
- ◆ Bullet lists provide information, but do not involve sequential steps.
- Indicates selecting the option (on a menu or dialog box, for example), that comes next. For example, Start → Run means to open the *Start* menu, and then select *Run*.
-  Indicates critical information.

Product Information

For information about all ATEN products and how they can help you connect without limits, visit ATEN on the Web or contact an ATEN Authorized Reseller. Visit ATEN on the Web for a list of locations and telephone numbers:

International	http://www.aten.com
North America	http://www.aten-usa.com

This Page Intentionally Left Blank

Chapter 1

Introduction

Overview

The CS1708i and CS1716i KVM switches are IP-based KVM control units that allow both local and remote operators to monitor and access multiple computers from a single console. For example, a single CS1708i or CS1716i can control up to 8 or 16 computers. By daisy chaining up to 15 additional CS1708A or CS1716A switches, as many as 128 or 256 computers can all be controlled from a single keyboard-monitor-mouse console.

Since the CS1708i / CS1716i uses TCP/IP for its communications protocol, it can be accessed from any computer on the Net - whether that computer is located down the hall, down the street, or half-way around the world.

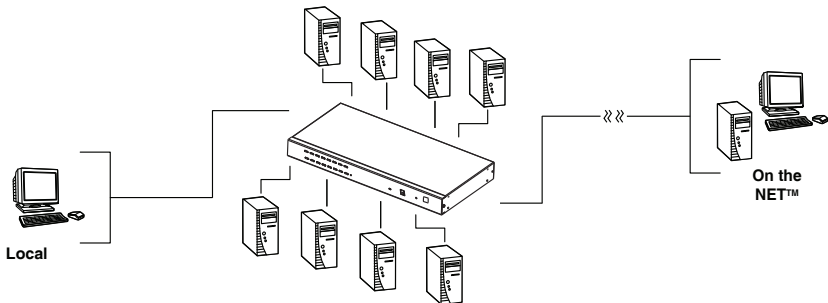

Remote operators can log in from anywhere on the net via their browser. Once they successfully log in, operators can take control using either the *Windows Client* or *Java Client* utility. Inclusion of a Java-based client allows the switches work with Java 2 enabled operating systems. The client software allows operators to exchange keyboard, video and mouse signals with the computers attached to the CS1708i / CS1716i just as if they were present locally and working on the equipment directly. With the Panel Array feature, the video output of up to 8 or 16 computers can be displayed at the same time.

In addition to TCP/IP connectivity, the CS1708i / CS1716i provides KVM ports for a local console – allowing access and control from the data center as well as over the Net. Local access to any computer on the installation is easily accomplished either by pressing the front panel port selection switches; entering hotkey combinations from the keyboard; or by means of a powerful

menu driven multilingual on-screen display (OSD) system. A convenient Auto Scan function also permits automatic scanning and one-by-one monitoring of the activities of selected computers.

Note: The switches utilize a single shared bus – although they support local and remote login at the same time, they do not support independent operation. If a local user logs in while a remote user has already opened a session, the local user sees the same screen that the remote user is working on.

For local access, the CS1708i / CS1716i supports resolutions of up to 2048 x 1536. For remote access, the switches support up to 1600 x 1200 @ 60Hz / 24 bit color depth.

Setup is fast and easy; plugging cables into their appropriate ports is all that is entailed. Because the switches intercept keyboard input directly, there is no need to get involved in complex software installation routines, or to be concerned with incompatibility problems.

A custom ASIC (patent pending) provides an auto-sensing function that recognizes the position of each station on the chain, eliminating the need to manually set the position with DIP switches. A seven segment front panel LED displays each station's position for easy identification.

By allowing a single console to manage all the attached computers, a CS1708i / CS1716i installation: eliminates the expense of having to purchase a separate keyboard, monitor, and mouse for each computer; saves all the space those extra components would take up; saves on energy costs; and eliminates the inconvenience and wasted effort involved in constantly moving from one computer to another.

Since the firmware is upgradeable, you can stay current with the latest functionality improvements simply by downloading firmware updates from our website as they become available.

With its advanced security features, the CS1708i / CS1716i provide the fastest, most reliable, most cost effective way to remotely access and manage widely distributed multiple computer installations.

Features

- ◆ A single console controls up to 8 (CS1708i) or 16 (CS1716i) computers
- ◆ Daisy chain up to 15 additional units – control up to 128 (CS1708i) or 256 (CS1716i) computers from a single console
- ◆ Auto-sensing of station's position on daisy chained installations; no need for manual dip switch setting; front panel led indicates station's position
- ◆ Hot pluggable – add or remove computers without having to power down the switch
- ◆ Port names automatically reconfigured when station sequence is changed
- ◆ Convenient computer selection via front panel pushbuttons, hotkeys and multilingual on-screen display (OSD) menus
- ◆ Multiplatform support – Windows 2000/XP/Vista, Linux, Mac, and Sun
- ◆ Secure keyboard/mouse/video transmission via RC4 128bit encryption
- ◆ Supports SSL 128bit data encryption and RSA 1024bit certificates for secure user logins from a browser
- ◆ Two level password security – up to 64 user accounts with separate profiles for each
- ◆ Up to 32 concurrent logins
- ◆ External (Remote) authentication support: RADIUS, LDAP, LDAPS, MS Active Directory
- ◆ Supports ALTUSEN CC (Central Control) Management
- ◆ Multilanguage web UI support featuring a tree-structured local and remote OSD
- ◆ On-screen keyboard with multilanguage support
- ◆ Front panel USB 1.1 hub allows connected computers to access USB peripherals
- ◆ Dual Interface – supports PS/2 or USB keyboard and mouse computer connections with automatic interface detection
- ◆ USB / PS/2 keyboard and mouse emulation – computers boot even when the console focus is elsewhere
- ◆ Supports USB keyboards for PC, Mac and Sun
- ◆ Mouse DynaSync™ – automatic locked-in synching of the remote and local mouse pointers

- ◆ Superior video quality – up to 2048 x 1536; DDC2B for the local console; up to 1600 x 1200 @ 60Hz / 24 bit color depth for remote sessions
- ◆ Video DynaSync– stores the console monitor's EDID (Extended Display Identification Data) to optimize display resolution
- ◆ Resizable remote desktop window
- ◆ Windows client and Java client software support; Java client works with all operating systems
- ◆ Panel array mode enables user to monitor multiple servers from single screen at the same time – each selected server's video output appears in a separate panel – users can easily select the number of panels to view
- ◆ Message board allows logged in users to communicate with each other, and allows a user to take exclusive control of the KVM functions
- ◆ Adjustable video quality for flexible adaptation to diverse network environments
- ◆ Auto Scan feature for monitoring user-selected computers
- ◆ Broadcast mode; operations simultaneously performed on all selected computers (software installation, system-wide shutdown, etc.).
- ◆ IPv6 capable
- ◆ Firmware upgradable
- ◆ Backup and restore configuration and user account settings
- ◆ Event logging
- ◆ Enable/disable browser access
- ◆ Rack mountable in a 19" (1U) system rack

Requirements

General

- ◆ For best results, we recommend that the computers used to access the CS1708i / CS1716i have at least a P III 1 GHz processor, and that their screen resolution is set to 1024 x 768
- ◆ For best results, we recommend an Internet connection speed of at least 128 kbps
- ◆ Browsers must support 128 bit data encryption
- ◆ To run the Windows client, you must have DirectX 8.0 or higher installed
- ◆ To run the Java client, you must have Sun's Java Runtime Environment (JRE) 6, Update 3, or higher installed
- ◆ To run the Log Server, you must have the Microsoft Jet OLEDB 4.0 (or higher) driver installed

Console

The following hardware components are required for the KVM console:

- ◆ A monitor capable of displaying the highest resolution provided by any computer in the installation.
- ◆ A keyboard and mouse (USB or PS/2).

Computers

The following hardware components are required for each computer:

- ◆ A video graphics card with an HDB-15 port.
- ◆ Either a Type A USB port and USB host controller (for connecting to a USB KVM Adapter Cable – see *Cables*, below); or
- ◆ 6-pin mini-DIN keyboard and mouse ports (for connecting to a PS/2 KVM Adapter Cable – see *Cables*, below).
- ◆ For Sun legacy systems, an ATEN CV130A Sun Console Converter (for PS/2 KVM Adapter Cable Connection – see *Cables*, below).

Cables

Substandard cables might damage the connected devices or degrade overall performance. For optimum signal integrity and to simplify the layout use the high quality custom cable sets described below.

Function		Length	Part Number
KVM switch to KVM switch (daisy chaining)		0.6 m	2L-1700
		1.8 m	2L-1701
KVM switch to computer	PS/2	1.2 m	2L-5201P
		1.8 m	2L-5202P
		3.0 m	2L-5203P
		6.0 m	2L-5206P
		1.8 m	2L-5702P
	USB	1.2 m	2L-5201U
1.8 m		2L-5202U	
3.0 m		2L-5203U	
5.0 m		2L-5205U	

Operating Systems

Supported operating systems are shown in the table, below:

OS		Version
Windows		2000 and higher
Linux	RedHat	7.1 and higher
	Fedora	Core 5 and higher
	SuSE	9.0 and higher
	Mandriva (Mandrake)	9.0 and higher
UNIX	AIX	4.3 and higher
	FreeBSD	3.51 and higher
	Sun	Solaris 8 and higher
Novell	Netware	5.0 and higher
Mac		OS 9 and higher
DOS		6.2 and higher

Browsers

Supported browsers for users that log into the KVM On the NET™ switch include the following:

Browser	Version
IE	6 and higher
Firefox	1.5 and higher
Mozilla	1.7 and higher
Safari	4.0 and higher
Opera	9.0 and higher
Netscape	8.1 and higher

Components

Front Panel

CS1708i

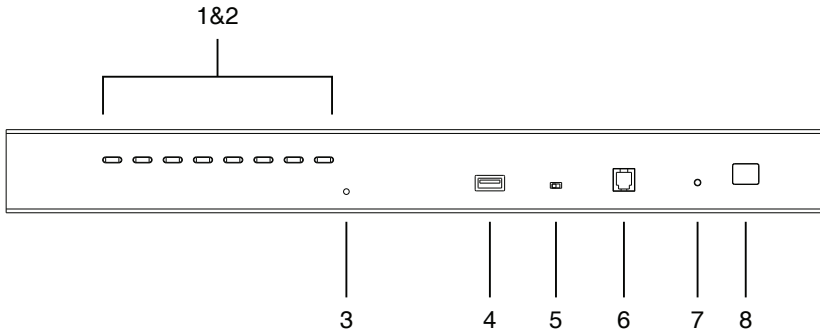

CS1716i

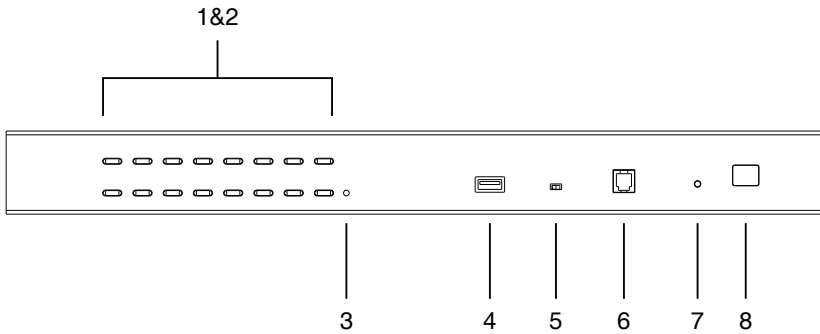

No.	Component	Description
1	Port Selection Switches	<p>Press a button to give the KVM focus to the computer attached to its corresponding port.</p> <ul style="list-style-type: none"> ◆ Simultaneously pressing Buttons 1 and 2 for 3 seconds performs a Keyboard and Mouse Reset. ◆ Simultaneously pressing buttons 7 & 8 on the CS1708i, or buttons 15 & 16 on the CS1716i, starts <i>Auto Scan</i> mode. See <i>F7: SCAN</i>, page 38
2	Port LEDs	<p>The Port LEDs are built into the Port Selection Switches. The ones on the left are the <i>On Line</i> LEDs; the ones on the right are the <i>Selected Port</i> LEDs:</p> <ul style="list-style-type: none"> ◆ An On Line LED lights ORANGE to indicate that the computer attached to its corresponding port is up and running. ◆ A Selected LED lights GREEN to indicate that the computer attached to its corresponding port is the one that has the KVM focus.
3	Reset Switch	<p>Pressing this switch performs a system reset. When the system is reset, the switch beeps, and the port LEDs flash in succession until the reset is complete. After the reset is complete you can login again.</p> <p>Note: This switch is recessed and must be pushed with a small object, such as the end of a paper clip or a ballpoint pen.</p>
4	USB Port	<p>USB peripherals (flash drive, CD-ROM, etc.) plug into this port. Peripherals can be shared among the connected computers.</p>
5	Firmware Upgrade Recovery Switch	<p>During normal operation and while performing a firmware upgrade, this switch should be in the NORMAL position. If a firmware upgrade operation does not complete successfully, this switch is used to perform a firmware upgrade recovery. See <i>Firmware Upgrade Recovery</i>, page 134, for details.</p>
6	Firmware Upgrade Port	<p>The firmware upgrade cable that transfers the firmware upgrade data from the administrator's computer to the CS1708i / CS1716i, plugs into this RJ-11 connector.</p>
7	Power LED	<p>Lights to indicate that the switch is powered up and ready to operate.</p>
8	Station ID LED	<p>The CS1708i / CS1716i station ID is displayed here. If this is a single station installation (see page 19), or the first station of a daisy chained installation (see page 21), the switch has a station ID of 01.</p> <p>On a daisy chained installation, the CS1708i / CS1716i auto-senses its position and displays the station ID that corresponds to its place in the chain. (see <i>Port IDNumbering</i>, page 25 for details).</p>

Rear Panel

CS1708i

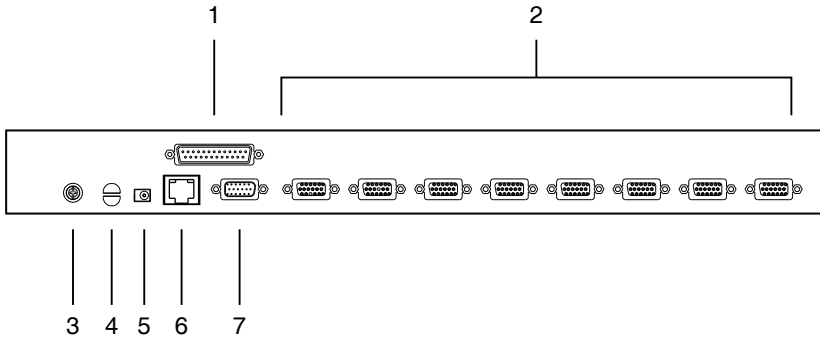

CS1716i

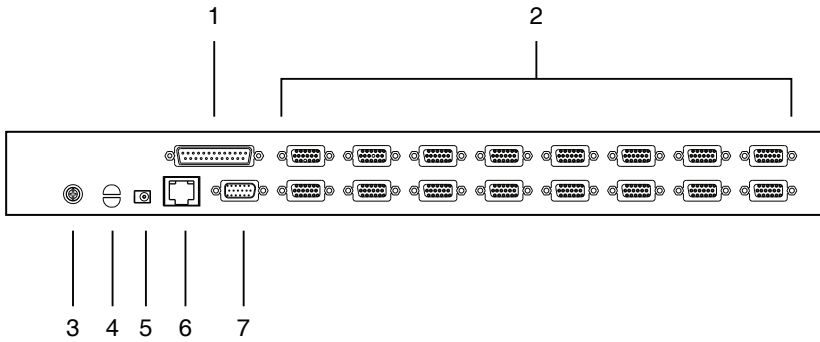

No.	Component	Description
1	Daisy Chain Port	When Daisy Chaining Units (see <i>Daisy Chaining</i> , page 21), the daisy chain cable plugs in here.
2	KVM Port Section	The KVM cables that link to the computers plug in here. Note: The shape of these 15-pin connectors has been specifically modified so that only custom KVM cables designed to work with this switch can plug in. (See <i>Cables</i> , page 6, for details.) Do NOT attempt to use ordinary 15-pin VGA connector cables to link these ports to the computers.
3	Grounding Terminal	The grounding wire used to ground the CS1708i / CS1716i attaches here.
4	Cable Tie Slot	If you want to use a cable tie to gather the cables together, you can run it through this slot to attach it to the unit.
5	Power Jack	The power adapter cable plugs in here.
6	LAN Port	The cable that connects the CS1708i / CS1716i to the Internet, LAN, or WAN plugs in here. The LED on the left side of the port indicates data transmission speed: <i>Orange</i> for 10 Mbps; <i>Green</i> for 100 Mbps. The LED on the right side of the port flashes <i>Green</i> when the switch is being accessed remotely.
7	Console Port	The custom Console Cable set that connects the console monitor, keyboard, and mouse to the switch plugs in here.

This Page Intentionally Left Blank

Chapter 2

Hardware Setup

Overview

For convenience and flexibility that allows mixing PS/2 and USB interfaces, as well as multiple platforms, the CS1708i / CS1716i design utilizes custom KVM cables that serve as intermediaries between the switch and the connected computers (refer to the *Cable Connection Diagrams*, on page 20).

A separate custom KVM cable is required for each computer connection. The custom KVM cables are listed under *Cables*, on page 6. Consult your dealer to find out which custom KVM cables best fit your needs.

Before You Begin



1. Important safety information regarding the placement of this device is provided on page 135. Please review it before proceeding.
2. Make sure that power to all devices that you will be installing has been turned off. You must unplug the power cords of any computers that have the Keyboard Power On function.

Stacking and Rack Mounting

The CS1708i / CS1716i can be stacked on the desktop or rack mounted at the front or rear of the rack. The following sections take you through the procedures for each method.

-
- Note:** 1. Allow at least 5.1 cm on each side for adequate ventilation and 12.7 cm at the rear for power cord and cable clearance.
2. The standard rack mounting kit does not include screws or cage nuts. If you need additional screws or cage nuts, contact your rack dealer.
-

Stacking

The CS1708i / CS1716i can be placed on any level surface that can safely support its weight and the weight of the attached cables. Make sure that the surface is clean and free of any materials that can block the exhaust vents or otherwise interfere with normal operation of the switch.

To place the CS1708i / CS1716i, or to stack units if you are daisy chaining them, remove the backing material from the bottom of the rubber feet that came with this package, and stick them onto the bottom panel at the corners, as shown in the diagram, below:

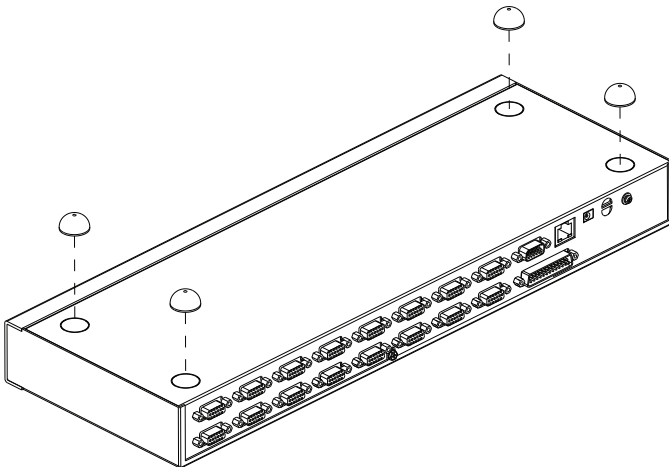

Rack Mounting – Front

1. Remove the screws from the left and right sides of the switch (2 screws total) near the front of the switch.

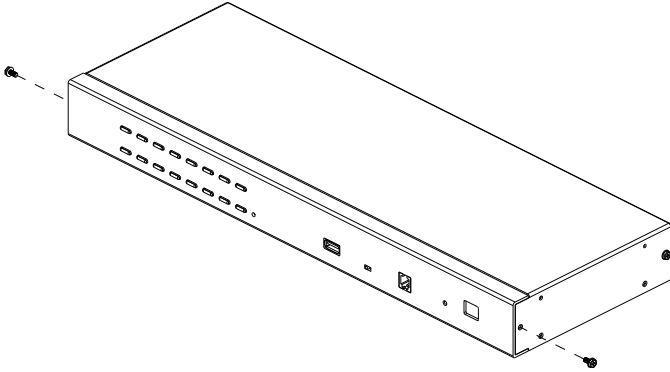

2. Use the M3 x 8 Phillips hex head screws supplied with the rack mounting kit to screw the rack mounting brackets into the sides near the front of the unit.

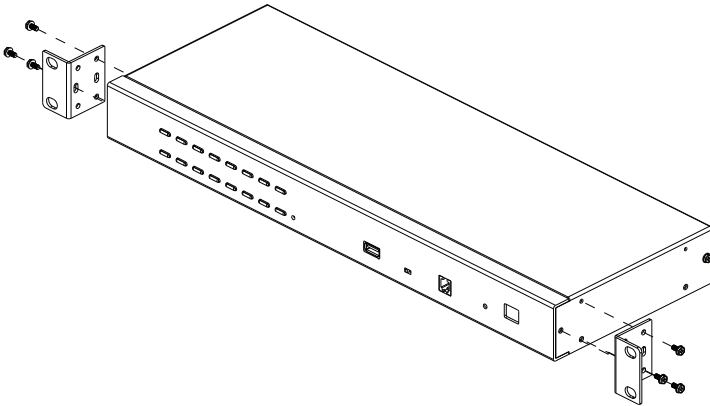

(Continues on next page.)

(Continued from previous page.)

3. Place the KVM switch in the rack. Position it so that the holes in the mounting brackets line up with the holes in the rack. Secure the mounting brackets to the front of the rack.

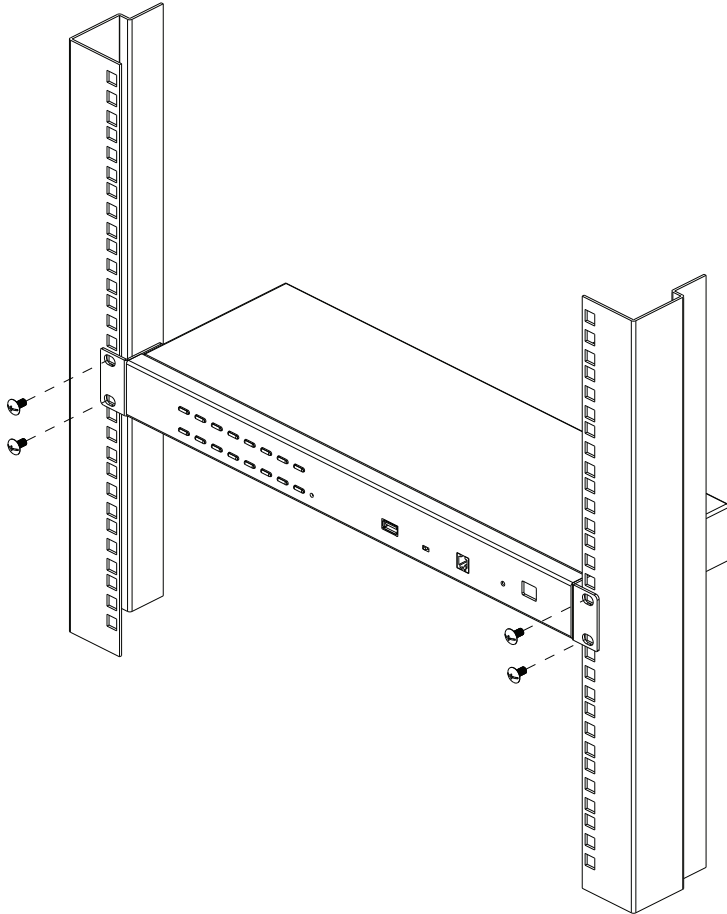

Rack Mounting – Rear

1. Remove 1 screw each from the left and right sides of the switch (2 screws total) near the rear of the unit.

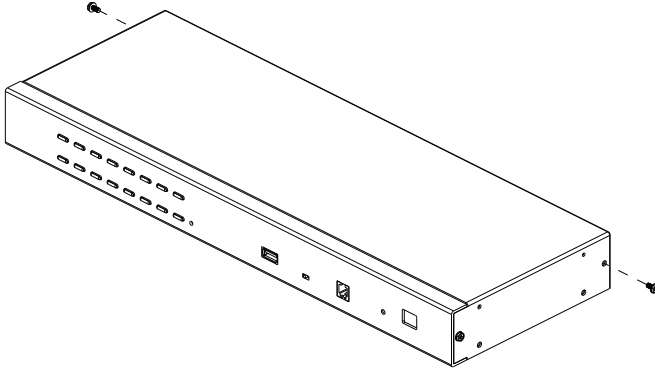

2. Use the M3 x 8 Phillips hex head screws with the rack mounting kit to screw the rack mounting brackets into the sides near the rear of the unit.

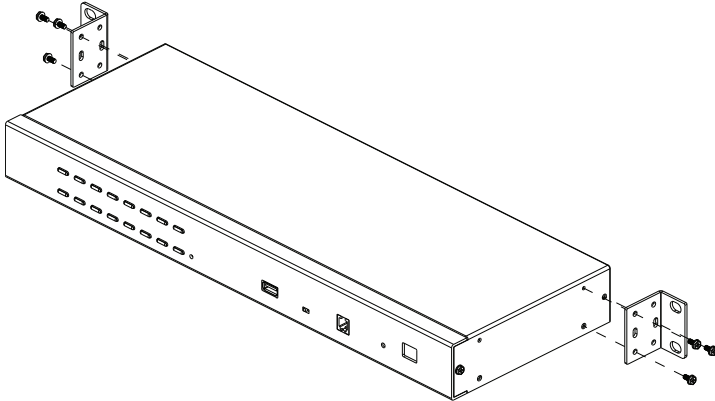

(Continues on next page.)

(Continued from previous page.)

3. Place the KVM switch in the rack. Position it so that the holes in the mounting brackets line up with the holes in the rack. Secure the mounting brackets to the rear of the rack.

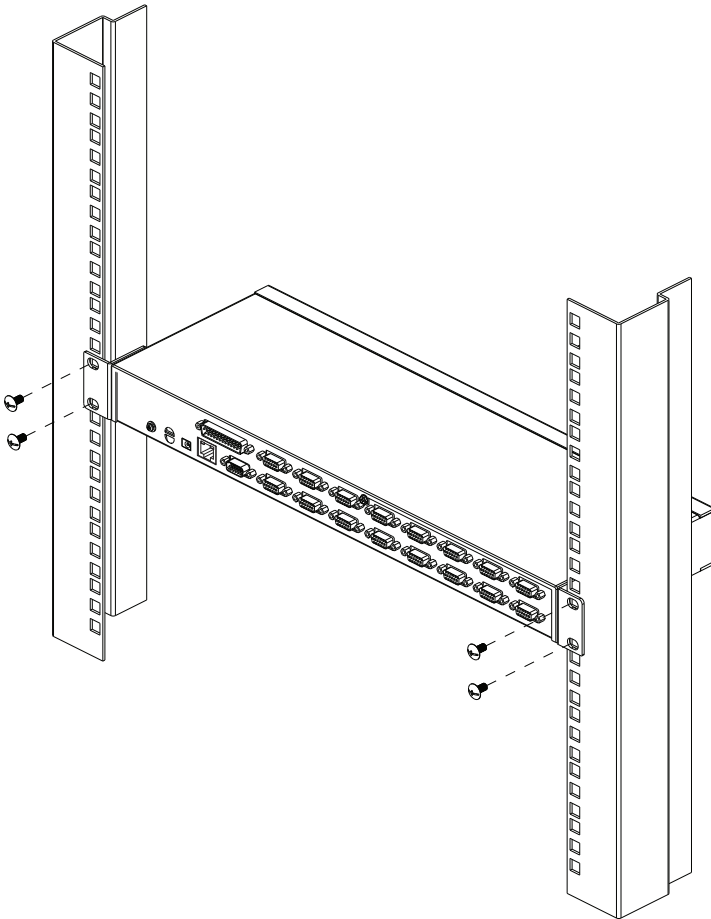

Single Station Installation

To set up a single station installation refer to the diagram below (the numbers in the diagram correspond with the numbers of the instruction steps), and do the following:

1. Ground the CS1708i / CS1716i by connecting one end of the grounding wire to the grounding terminal, and the other end of the wire to a suitable grounded object.
2. Using the console cable provided with your switch, connect a USB or PS/2 keyboard, mouse, and monitor to the CS1708i / CS1716i console port. (See *Console Cable Installation Diagram* on the following page.)
3. Use KVM cable sets (as described in the *Cables* section on page 6), to connect any available KVM port to the keyboard, video and mouse ports of the computer you are installing. (See *KVM Cable Installation Diagrams* on the following page.)
4. Plug the power adapter cable into the CS1708i / CS1716i power jack, then plug the power adapter into an AC power source.

After all the equipment has been connected up, power on the computers.

Single Station Installation Diagram

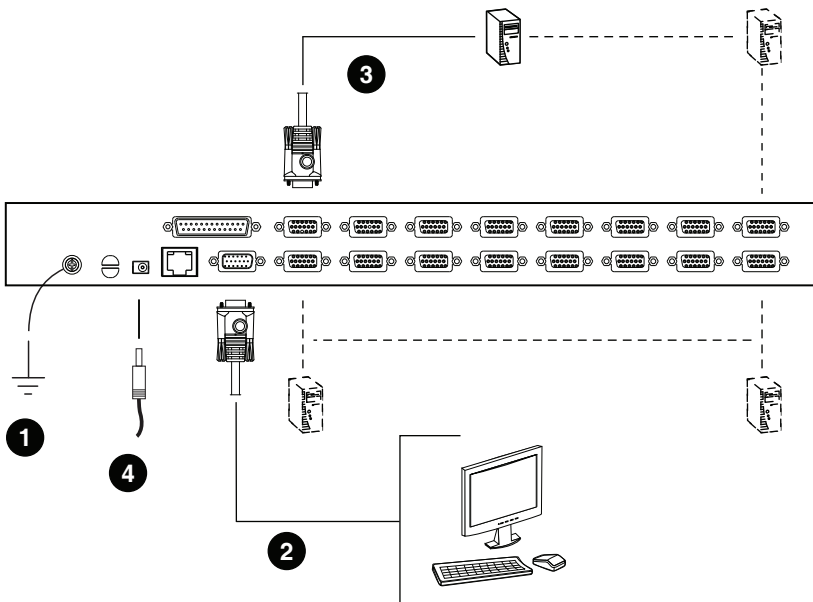

Cable Connection Diagrams

Console Cable Installation Diagram

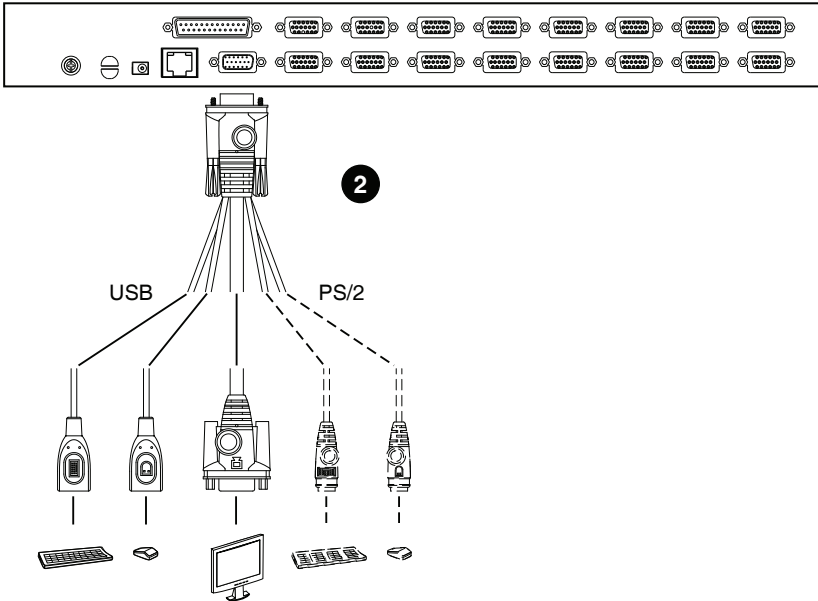

KVM Cable Installation Diagrams

USB KVM Cable Connection

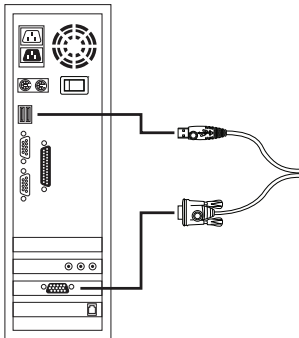

PS/2 KVM Cable Connection

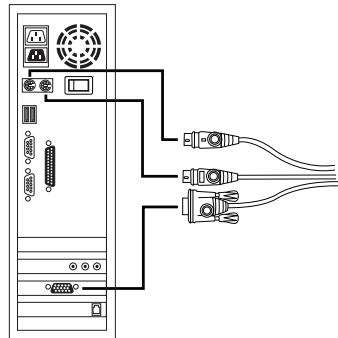

Daisy Chaining

To control even more computers, up to 15 additional switches can be daisy chained down from the CS1708i / CS1716i. As many as 128 (CS1708i) or 256 (CS1716i) computers can be controlled from a single console in a complete installation.

-
- Note:**
1. Tables showing the relation between the number of computers and the number of CS1708i / CS1716i units needed to control them are provided on page 155.
 2. A list of supported KVM switches is provided on page 156.
-

To set up a daisy chained installation, refer to the installation diagram on the following page, and do the following:

1. Make sure that all the switches you are adding to the chain are properly grounded.
2. Use a daisy chain cable set (described in the *Cables* section, page 6), to connect the *Chain Out* port of the CS1708i / CS1716i to the *Chain In* port of the first chained unit.
3. To add additional switches to the chain, use daisy chain cable sets to connect the *Chain Out* port of the parent switch to the *Chain In* port of the child switch.
4. Connect the chained switches to their computers using appropriate KVM cable sets (described in the *Cables* section, page 6), according to the information given for single station installations.

Powering Up

After all the equipment has been connected up, power up the installation according to the following procedure:

1. Plug in the power adapter for the CS1708i / CS1716i.
Wait for the unit's station ID to display on the station ID LED.
The CS1708i / CS1716i is the first station. Its station ID is **01**.
2. Plug in the power adapters for each station on the installation in turn (second station, then third station, etc.).
3. In each case, wait for the station ID to be ascertained and displayed on the current station before plugging in the next one.
4. After all the stations are up, power on the computers.

Daisy Chain Installation Diagram

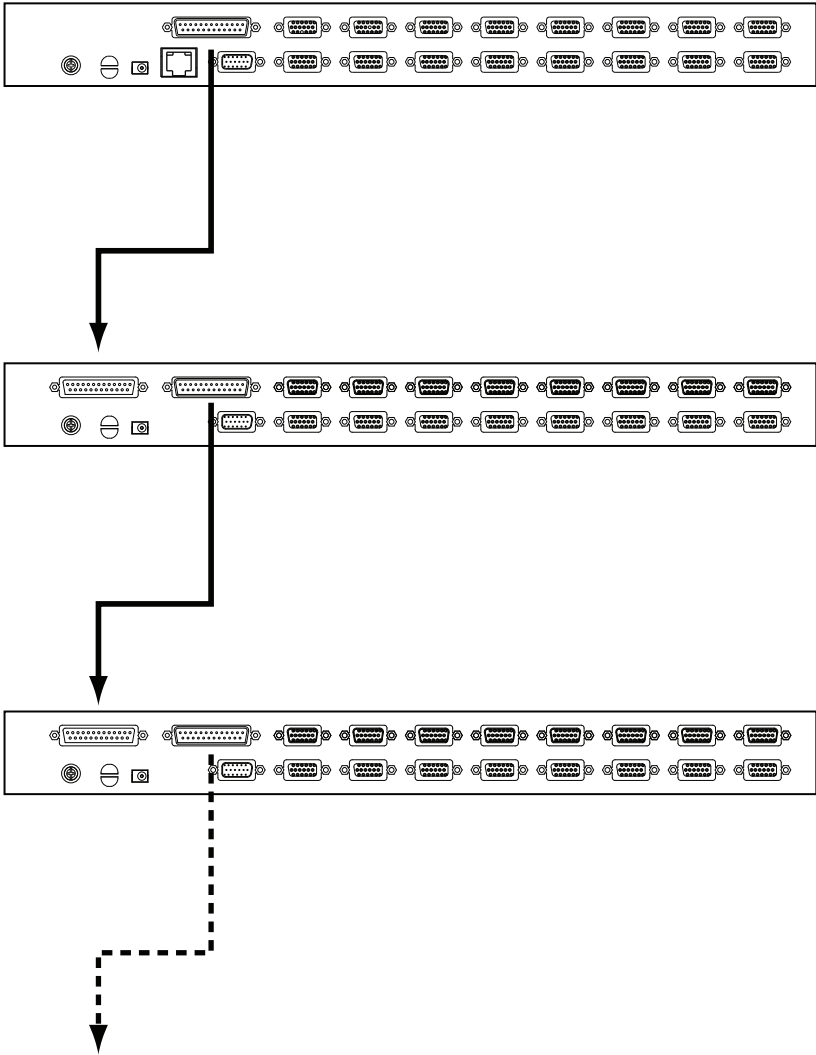

Chapter 3

Basic Operation

Port Selection

CS1708i / CS1716i installations provide three methods to obtain instant access to any computer in your installation: Manual, OSD, and *Hotkey*.

Manual

For manual port selection, simply press the Port Selection Switch that corresponds to the device you wish to access.

OSD/GUI

The CS1708i / CS1716i provides two menu driven interfaces to the port selection procedure: A text-based OSD (On Screen Display), when you log in from a local console; and a GUI (Graphical User Interface) when you log in remotely over the internet. Local console OSD operation is discussed in the next chapter; GUI operations are discussed in Chapter 7 (for Windows logins) and Chapter 8 (for Java logins).

Keyboard Hotkeys

Hotkeys allow you to conveniently provide KVM focus to a particular computer from the local console keyboard, instead of having to manually select them by pressing Port Selection switches. See *Hotkey Operation*, page 40, for details.

Hot Plugging

The CS1708i / CS1716i supports *hot plugging* – components can be removed and added back into the installation by unplugging and replugging their cables from the switch's ports without the need to shut the unit down. In order for hot plugging to work properly, however, the procedures described below must be followed:

Hot Plugging Stations

You can change a station's position by simply disconnecting it from its master and reconnecting it to another switch in the chain. In order for the OSD menus to correspond to the change, the station IDs must be reset in the OSD. See *RESET STATION IDS*, page 35 for details.

Hot Plugging KVM Ports

After switching KVM ports, in order for the OSD menus to correspond to the change, you must manually reconfigure the OSD information for the new Port information. See *F3: SET*, page 32, and the Port Setting selections under the *F4 ADM* function, page 34, for details.

Note: If the computer's Operating System doesn't support hot plugging, this function may not work properly.

Hot Plugging Console Ports

The keyboard, monitor, and mouse can all be hot plugged. When hot plugging the mouse:

- ♦ You may unplug and replug the mouse (to reset the mouse, for example), as long as you use the same mouse.
- ♦ If you plug in a different mouse, all the stations and all the computers on the installation must be shut down for 10 seconds, then restarted following the power up sequence described under Step 5 on page 21.

Note: If, after hot plugging there is no response to keyboard and/or mouse input, perform a *Keyboard and Mouse Reset* by simultaneously pressing the 1 and 2 front panel port LEDs.

Port ID Numbering

Each computer on a CS1708i / CS1716i installation is assigned a unique *Port ID*. The Port ID is made up of two parts: a *Station Number*, and a *Port Number*:

- ◆ The *Station Number* represents the position of the switch that the computer is connected to in the daisy chain sequence.
- ◆ The *Port Number* represents the position of the port that the computer is connected to on the CS1708i / CS1716i station.
- ◆ The station number precedes the port number.
- ◆ Station and port numbers from 1–9 are padded with a preceding zero, so they become 01–09.

For example, a computer attached to Port 6 of a station that was 12th in the daisy chain sequence, would have a Station Number of 12 and a Port Number of 06. It's Port ID would be: **12-06**.

Powering Off and Restarting

If it becomes necessary to power off a CS1708i / CS1716i, do the following before restarting it:

1. Shut down all the computers that are attached to the CS1708i / CS1716i.

Note: Unplug the power cords of any computers that have the *Keyboard Power On* function. Otherwise, the CS1708i / CS1716i will still receive power from the computers.

2. Unplug the CS1708i / CS1716i from its power source.
3. Wait 10 seconds, then plug the CS1708i / CS1716i back in.
4. After the CS1708i / CS1716i has started and ascertained its station ID, power on the computers.

Note: If you have shut down more than one station, power up the highest station first and work your way down to the lowest one.

USB Peripheral Devices

The front panel USB port is available to connect a USB peripheral device (flash drive, CD-ROM drive, printer, etc.) to the CS1708i / CS1716i. Any computer connected to the CS1708i / CS1716i can access the USB peripheral on a one-at-a-time basis.

Note: Peripheral devices are only available to computers directly connected to a CS1708i / CS1716i on the same level. They are not available to computers connected to daisy chained switches.

USB peripherals are automatically detected on target computers when you switch ports. For example, when you switch from port 1 to port 2, the peripheral automatically disconnects from the computer on port 1 and connects to the computer on port 2.

Chapter 4

Local Console Operation

Overview

When setting up your CS1708i / CS1716i installation for the first time, we recommend doing it from the local console. Local console operation offers a menu driven On Screen Display (OSD) to handle computer control and switching operations.

All procedures start from the OSD Main Screen. To pop up the Main Screen, tap **[Scroll Lock]** twice.

Note: [Scroll Lock] is the default OSD hotkey. You can optionally change the Hotkey to the Ctrl key (see *OSD HOTKEY*, page 32).

The login screen appears:

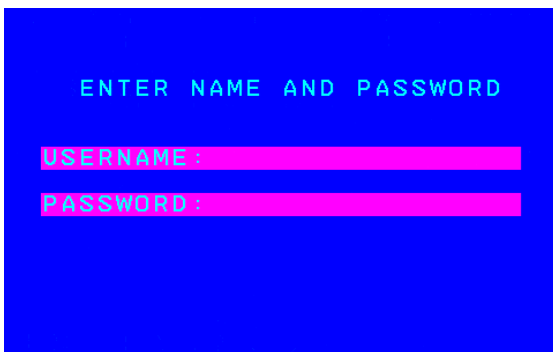

Enter a valid Username and password to continue.

-
- Note:** 1. The default username is *administrator*; the default password is *password*. The first time you log in, you must use these defaults. For security purposes, we strongly recommend that you change the default password to something unique.
2. Usernames and passwords cannot be managed from the local console. User management is handled via remote administration. See *User Management*, page 67 for details.
-

OSD Main Screen

When you invoke the OSD, a screen similar to the one below appears:

```

F1:GOTO F3:SET F5:SKP F7:SCAN
F2:LIST F4:ADM F6:BRC F8:LOUT
ADMINISTRATOR
LIST:ALL
SN--PN QV  NAME
01
  01  [+]  ASUS P4P800
  02
  03  [+]  SUN BLADE150
  04
  05      MSI NEO2
  06      IBM SERVER
  07      HP G4
  08      DELL GX620

```

- ◆ The diagram depicts the administrator's main screen. The user main screen does not show the **F4** and **F6** functions, since these are reserved for the administrator and can't be accessed by users.
- ◆ The OSD always starts in *LIST* view, with the highlight bar at the same position it was in the last time it was closed.
- ◆ Only the ports that have been set accessible by the administrator for the current logged in user are visible (see *Port Access*, page 99 for details).
- ◆ The OSD uses a tree view. If a switch's port list is collapsed, a plus symbol displays in front of its Station Number. To see the ports click on the switch's Station Number, or move the highlight bar to it then press the right arrow key. If you wish collapse a switch's port list, click on the switch's Station Number, or move the highlight bar to it then press the left arrow key.

OSD Navigation

- ◆ To dismiss the menu, and deactivate OSD, click the **X** at the upper right corner of the OSD window; or press **[Esc]**.
- ◆ To log out, click **F8** at the top of the main screen, or press **[F8]**.
- ◆ To move up or down through the list one line at a time, Click the Up and Down Triangle symbols (**▲▼**) or use the Up and Down Arrow Keys. If there are more list entries than there is room for on the Main Screen, the screen will scroll.
- ◆ To move up or down through the list one screen at a time, Click the Up and Down Arrow symbols (**↑↓**), or use the [Pg Up] and [Pg Dn] keys. If there are more list entries than there is room for on the Main Screen, the screen will scroll.
- ◆ To bring the KVM focus to a port, Double Click it, or move the Highlight Bar to it then press **[Enter]**.
- ◆ After executing any action, you automatically go back to the menu one level above.

OSD Main Screen Headings

SN--PN	This column lists the Port ID numbers (Station Number - Port Number) for all the KVM Ports on the installation. The simplest method to access a particular computer is move the Highlight Bar to the port entry, then press Enter .
QV	If a port has selected for Quick View scanning (see <i>SET QUICK VIEW PORTS</i> , page 35), an arrowhead displays in this column to indicate so.
	The computers that are powered on and are online have a sun symbol in this column to indicate so.
NAME	If a port has been given a name (see <i>EDIT PORT NAMES</i> , page 34), its name appears in this column.

OSD Functions

OSD functions are used to configure and control the OSD. For example, you can rapidly switch to any port, scan selected ports, limit the list you wish to view, designate a port as a quick view port, create or edit a port name, or make OSD setting adjustments.

To access an OSD function:

1. Either Click a Function Key field at the top of the Main Screen, or press a Function Key on the keyboard.
2. In the Submenus that appear make a choice by either double clicking it, or by moving the Highlight Bar to it, and pressing **[Enter]**.
3. Press **[Esc]** to return to the previous menu level.

F1: GOTO

GOTO allows you to switch directly to a port either by keying in the port's *Name*, or its *Port ID*.

- ◆ To use the name method, key in **1**; key in the port's *Name*; then press **[Enter]**.
- ◆ To use the Port ID method, key in **2**; key in the *Port ID*; then press **[Enter]**.

Note: 1. You can key in a partial Name or Port ID. In that case, the screen will show all the computers that the User has *View* rights to (see *Port Access*, page 99), that match the Name or Port ID pattern, regardless of the current List settings (see *F2: LIST*, page 31, for details).

2. Port access rights are assigned via the remote OSD. See *User Management*, page 98 for details
-

To return to the OSD main screen without making a choice, press **[Esc]**.

F2: LIST

This function lets you broaden or narrow the scope of which ports the OSD displays (lists) on the Main OSD Screen. Many of the OSD functions only operate on the computers that are listed on the Main OSD Screen. The submenu choices and their meanings are given in the table below.

Choice	Meaning
ALL	Lists all of the ports on the installation that have been set accessible by the administrator for the current logged in user.
QUICK VIEW	Lists only the ports that have been selected as Quick View Ports (see <i>SET QUICK VIEW PORTS</i> , page 35).
POWERED ON	Lists only the ports that have their attached computers powered on.
QUICK VIEW + POWERED ON	Lists only the ports that have been selected as Quick View Ports (see <i>SET QUICK VIEW PORTS</i> , page 35, and that have their attached computers Powered On.

Move the highlight bar to the choice you want, then press **[Enter]**. An icon appears before the choice to indicate that it is the currently selected one.

F3: SET

This function allows the administrator and each user to set up his own working environment. A separate profile for each is stored by the OSD and is activated according to the username that was provided during login.

To change a setting:

1. Double-click it; or move the highlight bar to it, then press **[Enter]**.
2. After you select an item, a submenu with further choices appears. To make a selection, either double-click it; or move the highlight bar to it, then press **[Enter]**. An icon appears before the selected choice to indicate which one it is. The settings are explained in the following table:

Setting	Function
OSD HOTKEY	Selects which hotkey activates the OSD function: [Scroll Lock] [Scroll Lock] or [Ctrl] [Ctrl] . Since the [Ctrl] key combination may conflict with programs running on the computers, the default is the [Scroll Lock] combination.
PORT ID DISPLAY POSITION	Allows each user to customize the position where the Port ID appears on the screen. The default is the upper left corner, but users can choose to have it appear anywhere on the screen. Use the mouse or the arrow keys plus Pg Up, Pg Dn, Home, End, and 5 (on the numeric keypad with Num Lock off), to position the Port ID display, then double-click or press [Enter] to lock the position and return to the Set submenu.
PORT ID DISPLAY DURATION	Determines how long a Port ID displays on the monitor after a port change has taken place. The choices are: 3 Seconds (default) and Always Off .
PORT ID DISPLAY MODE	Selects how the Port ID is displayed: the port number plus the port name (PORT NUMBER + PORT NAME) (default); the port number alone (PORT NUMBER); or the port name alone (PORT NAME).
SCAN DURATION	Determines how long the focus dwells on each port as it cycles through the selected ports in Auto Scan Mode (see <i>F7: SCAN</i> , page 38). Key in a value from 0–255 seconds, then press [Enter] . Default is 5 seconds; a setting of 0 disables the Scan function.

Setting	Function
SCAN-SKIP MODE	<p>Selects which computers will be accessed under Skip Mode (see <i>F5: SKP</i>, page 36), and Auto Scan Mode (see <i>F7: SCAN</i>, page 38). Choices are:</p> <p>ALL - All the Ports which have been set Accessible (see <i>Port Access</i>, page 99),</p> <p>POWERED ON - Only those Ports which have been set Accessible and are Powered On;</p> <p>QUICK VIEW - Only those Ports which have been set Accessible and have been selected as Quick View Ports (see <i>SET QUICK VIEW PORTS</i>, page 35);</p> <p>QUICK VIEW + POWERED ON - Only those Ports which have been set Accessible and have been selected as Quick View Ports and are Powered On.</p> <p>The default is ALL.</p> <p>Note: The quick view choices only show up on the administrator's screen, since only he has <i>Quick View</i> setting rights (see <i>SET QUICK VIEW PORTS</i>, page 35, for details).</p>
SCREEN BLANKER	<p>If there is no input from the console for the amount of time set with this function, the screen is blanked. Key in a value from 0–30 minutes, then press [Enter]. A setting of 0 disables this function. The default is 0 (disabled).</p>
HOTKEY COMMAND MODE	<p>Enables / Disables the Hotkey Command function in case a conflict with programs running on the computers occurs. The default is ON.</p>
HOTKEY	<p>This setting selects the Hotkey invocation keys (see <i>Invoking Hotkey Mode</i>, page 41). Choices are:</p> <p>[Num Lock] + [-] or [Ctrl] + [F12]</p> <p>The default is [Num Lock] + [-].</p>
OSD LANGUAGE	<p>Sets the language used in the OSD. Choices are: English (default), German, Japanese, Simplified Chinese and Traditional Chinese.</p>

F4: ADM

F4 is an administrator only function. It allows the administrator to configure and control the overall operation of the OSD. To change a setting double-click it, or use the up and down arrow keys to move the highlight bar to it then press **[Enter]**.

After you select an item, a submenu with further choices to select from appears. Double-click an item, or move the highlight bar to it then press **[Enter]**. An icon appears before the selected item so that you know which one it is. The settings are explained in the following table:

Setting	Function
SET IP ADDRESS	<p>This entry allows you to select whether to assign the CS1708i / CS1716i's IP address dynamically (DHCP), or to give it a fixed IP address. Press [Space] to toggle between the choices.</p> <p>If you toggle <i>DHCP Enable</i> to Off, specify the IP, Mask, and Gateway in the appropriate fields. (Methods to determine the CS1708i / CS1716i's IP address are described in the Appendix on page 145.)</p> <p>Press [Esc] to exit after you have finished with your choice.</p>
SET LOGOUT TIMEOUT	<p>If there is no input from the console for the amount of time set with this function, the Operator is automatically logged out. A login is necessary before the console can be used again.</p> <p>This enables other Operators to gain access to the computers when the original Operator is no longer accessing them, but has forgotten to log out. To set the timeout value, key in a number from 0–180 minutes, then press [Enter]. If the number is 0 (zero), this function is disabled. Default is 0 (disabled).</p>
EDIT PORT NAMES	<p>To help remember which computer is attached to a particular port, every port can be given a name. This function allows the administrator to create, modify, or delete port names.</p> <p>To edit a port name:</p> <ol style="list-style-type: none"> Click the port, or use the navigation keys to move the highlight bar to it, then press [Enter]. Key in the new port name, or modify/delete the old one. The maximum number of characters allowed for the port name is 12. Legal characters include: <ul style="list-style-type: none"> ◆ All alpha characters: A–Z ◆ All numeric characters: 0–9 ◆ - and Space <p>Case does not matter; OSD displays the port name in all capitals no matter how they were keyed in.</p> When you have finished editing, press [Enter] to have the change take effect. To abort the change, press [Esc].

Setting	Function
RESTORE DEFAULT VALUES	This function is used to undo all changes and return the setup to the original factory default settings (see <i>Restoring Factory Default Settings</i> , page 157).
CLEAR THE NAME LIST	This function is similar to Restore Default Values. The difference is that it also clears the <i>Names</i> settings along with undoing all changes and returning the setup to the original factory default settings.
ACTIVATE BEEPER	Choices are Y (On), or N (Off). When activated, the beeper sounds whenever a port is changed; when activating the Auto Scan function (see <i>F7: SCAN</i> , page 38); or an invalid entry is made on an OSD menu. The default is Y .
SET QUICK VIEW PORTS	<p>This function lets the administrator select which ports to include as quick view ports.</p> <ul style="list-style-type: none"> ◆ To select/deselect a port as a Quick View Port, double-click the port, or use the navigation keys to move the highlight bar to it, then press [Spacebar]. ◆ When a port has been selected as a Quick View Port, an icon displays in the QV column of the port list on the Main Screen. When a port is deselected, the icon disappears. ◆ If one of the Quick View options is chosen for the LIST view (see <i>F2: LIST</i>, page 31), only a port that has been selected here will display on the list. ◆ If one of the quick view options is chosen for Auto Scanning (see <i>SCAN-SKIP MODE</i>, page 33), only a port that has been selected here will be Auto Scanned. <p>The default has no ports selected for Quick View.</p>
RESET STATION IDS	<p>If you change the position of one of the Stations in the daisy chain, the OSD settings will no longer correspond to the new situation. This function directs the OSD to rescan the Station positions of the entire installation and updates the OSD so that the OSD Station information corresponds to the new physical layout.</p> <p>Note: Only the Station Numbers get updated. Except for the Port Names, all Administrator settings (such as Set Accessible Ports, Set Quick View Ports, etc.), for all of the computers affected by the change, have to be manually redone.</p>
SET OPERATING SYSTEM	<p>Specifies the operating platform of the computer attached to each port. For each port, press [Space] to cycle through the choices (Win, Mac1, Sun, and Mac2). Repeat until all the ports have been set, then press [Esc]. The default is Win.</p> <p>Note: If you are installing a Sun or Mac computer, before you run it for the first time you must set the correct operating system for the port it is connected to with this function; otherwise, it will not boot.</p>

Setting	Function
FIRMWARE UPGRADE	In order to upgrade the CS1708i / CS1716i firmware (see page 129), you must first enable Firmware Upgrade mode with this setting. When you bring up this menu, the current firmware version levels are displayed. Select Y to enable Firmware Upgrade mode, or N to leave this menu without enabling it.
KEYBOARD LANGUAGE	Sets the keyboard mapping for the computer keyboard attached to the KVM port. To select a keyboard language, double click it, or use the navigation keys to move the highlight bar to it, then press [Enter] . Choices are: AUTO (default), ENGLISH (US), ENGLISH (UK), GERMAN (GER.), GERMAN (SWISS), FRENCH, HUNGARIAN, ITALIAN, JAPANESE, KOREAN, RUSSIAN, SPANISH, SWEDISH and TRADITIONAL CHINESE.

F5: SKP

This function enables you to easily skip backward or forward – switching the console focus from the currently active KVM port to the previous or next available one.

The selection of computers that are available for Skip Mode switching is made with the *Scan-Skip* mode setting under the **F3: SET** function (see *SCAN-SKIP MODE*, page 33). When you are in Skip Mode, press:

- [←] To skip from the current port to the previous port in the List.
- [→] To skip from the current port to the next port in the List.
- [↑] To skip from the current port to the last port of the previous station in the List.
- [↓] To skip from the current port to the first port of the next station in the List.

Note: When you skip, you only skip to the previous or next available computer that is in the *Scan-Skip Mode* selection.

- ♦ If a Port has been selected for *Scan-Skip Mode*, when the focus switches to that port a Left/Right Triangle symbol appears before its Port ID Display to indicate so.
- ♦ While Skip Mode is in effect, the console will not function normally. You must exit Skip Mode in order to regain control of the console.
- ♦ To exit Skip Mode, press **[Space]** or **[Esc]**.

F6: BRC

F6 is an administrator only function. When *Broadcast* (BRC) mode is in effect, commands sent from the console are broadcast to all available computers on the installation.

This function is particularly useful for operations that need to be performed on multiple computers, such as performing a system wide shutdown, installing or upgrading software, etc.

- ◆ While BRC mode is in effect, a speaker symbol appears before the Port ID display of the port that currently has the console focus.
- ◆ While BRC mode is in effect, the mouse will not function normally. You must exit BRC mode in order to regain control of the mouse.
- ◆ To exit BRC mode, invoke the OSD (with the OSD hotkey), then click the **F6** field, or press **[F6]**, to turn BRC mode off.

F7: SCAN

This function (also referred to as *Auto Scan Mode*) allows you to automatically switch the KVM focus among the available computers at regular intervals so that you can monitor their activity without having to take the trouble of switching manually.

- ◆ The selection of computers to be included for auto scanning is made with the *Scan-Skip* mode setting under the **F3: SET** function (see *SCAN-SKIP MODE*, page 33).
- ◆ The amount of time that each port displays for is set with the *Scan Duration* setting under the **F3: SET** function (see *SCAN DURATION*, page 32). When you want to stop at a particular location, press **[Space]** to stop scanning and exit Auto Scan Mode.
- ◆ If the scanning stops on an empty port, or one where the computer is attached but is powered Off, the monitor screen will be blank, and the mouse and keyboard will have no effect. Simply wait - after the *Scan Duration* time is up, the Scan function will move on to the next port.
- ◆ As each computer is accessed, an **S** appears in front of the Port ID display to indicate that it is being accessed under Auto Scan Mode.
- ◆ While Auto Scan Mode is in effect, the console will not function normally. You must exit Auto Scan Mode in order to regain control of the console.
- ◆ While you are in Auto Scan Mode, you can pause the scanning in order to keep the focus on a particular computer either by pressing **P**, or with a left-click of the mouse. See *Auto Scan Mode*, page 43, for details.
- ◆ To exit Auto Scan Mode, press the **[Space]** or **[Esc]**.

F8: LOU

Clicking the **F8** field, or pressing **[F8]** logs you out of OSD control of the computers, and blanks the console screen. This is different from simply pressing **[Esc]** when you are at the main screen to deactivate the OSD. With this function you must log in all over again to regain access to the OSD, whereas with **[Esc]**, all you have to do to reenter the OSD is tap the OSD hotkey.

-
- Note:**
1. When you reenter the OSD after logging out, the screen stays blank except for the OSD login screen. You must input your username and password before you can continue.
 2. If you reenter the OSD after logging out, and immediately use **[Esc]** to deactivate the OSD without having selected a port from the OSD menu, a null port message displays on the screen. The OSD hotkey will bring up the main OSD screen.
-

Hotkey Operation

Overview

In addition to the OSD, the CS1708i / CS1716i also supports port control and configuration options directly from the keyboard with the use of hotkey combinations.

Note: To use this function Hotkey Command Mode must be enabled.
See *HOTKEY COMMAND MODE*, page 33 for details

Hotkey port control allows you to provide KVM focus to a particular computer directly from the keyboard. The CS1708i / CS1716i provides the following Hotkey Port Control features:

- ◆ Selecting the Active Port
- ◆ Auto Scanning
- ◆ Skip Mode Switching

The following hotkey configuration operations can also be performed:

- ◆ Keyboard and Mouse Resets
- ◆ Setting the Beeper
- ◆ Toggling the Hotkey Invocation Keys
- ◆ Toggling the OSD Hotkey
- ◆ Setting the Port Operating System
- ◆ Restoring the OSD Default Values

Invoking Hotkey Mode

All Hotkey operations begin by invoking *Hotkey Mode*. Invoking Hotkey Mode takes three steps:

1. Hold down the **Num Lock** key;
2. Press and release the **minus** key;
3. Release the **Num Lock** key:

[Num Lock] + [-];

- Note:**
1. The sequence uses the default hotkey invocation method. If you selected the alternate hotkey invocation keys (see *HOTKEY*, page 33), you would use [Ctrl] and [F12], instead.
 2. The Minus (or F12) key must be released within one half second, otherwise Hotkey invocation is automatically cancelled.
-

When Hotkey Mode is active:

- ◆ The Caps Lock, and Scroll Lock LEDs flash in succession to indicate Hotkey Mode is active. They stop flashing and revert to normal status when you exit Hotkey Mode.
- ◆ A Command Line appears on the monitor screen. The command line prompt is the word *Hotkey*: in white text on a blue background, and displays the subsequent Hotkey information that you key in.
- ◆ Ordinary keyboard and mouse functions are suspended – only Hotkey compliant keystrokes (described in the sections that follow), can be input.
- ◆ Pressing [Esc] exits Hotkey Mode.

Hotkey Port Control

Selecting the Active Port

Each KVM port is assigned a Port ID (see *Port ID Numbering*, page 25). You can directly access any computer on the installation with a Hotkey combination that specifies the Port ID of the KVM port that the computer is connected to. The steps involved are:

1. Invoke Hotkey Mode (see page 41).
2. Key in the Port ID

The Port ID numbers display on the Command Line as you key them in. If you make a mistake, use **[Backspace]** to erase the wrong number.

Note: 1. Just key in the numbers; do not key in the dash.

2. If the port you want to switch to is on the current station, you can just key in the port number – you do not need to key in the station number.

-
3. Press **[Enter]**

After you press [Enter], the KVM focus switches to the designated computer and you automatically exit Hotkey Mode.

Note: The KVM focus will not switch to a port if an invalid switch or port number is entered. The command line will continue to display on the screen until you enter a valid switch and port number combination, or exit hotkey mode.

Auto Scan Mode

Auto Scan Mode automatically switches among all the KVM ports that have been set as accessible under *Scan-Skip Mode* at regular intervals, so that their activity can be monitored automatically. (See *SCAN-SKIP MODE*, page 33.)

To start *Auto Scan Mode*, do the following:

1. Invoke Hotkey Mode (see page 41).
2. Press **[A]**.

After you press **A**, you automatically exit Hotkey Mode; enter *Auto Scan Mode*; and Auto Scanning begins.

- ◆ While you are in Auto Scan Mode, you can pause the scanning in order to keep the focus on a particular computer either by pressing **P** or with a left click of the mouse. During the time that auto scanning is paused, the command line displays: **Auto Scan: Paused**.

Pausing when you want to keep the focus on a particular computer is more convenient than exiting Auto Scan Mode because when you resume scanning, you start from where you left off. If, on the other hand, you exited and restarted, scanning would start over from the very first computer on the installation.

To resume auto scanning, press any key or left-click. Scanning continues from where it left off.

- ◆ While Auto Scan Mode is in effect, ordinary keyboard and mouse functions are suspended – only Auto Scan Mode compliant keystrokes and mouse clicks can be input. You must exit Auto Scan Mode in order to regain normal control of the console.
3. To exit Auto Scan Mode press **[Esc]** or **[Spacebar]**. Auto scanning stops when you exit Auto Scan Mode.

Skip Mode

This feature allows you to switch between computers in order to monitor them manually. You can dwell on a particular port for as long as you like – as opposed to auto scanning, which automatically switches after a fixed interval. To invoke *Skip Mode*, do the following:

1. Invoke Hotkey Mode (see page 41).
2. Key in **[Arrow]**
 - ◆ Where [Arrow] refers to one of the Arrow keys. After you press [Arrow], you automatically exit Hotkey Mode, and enter Skip Mode where you can switch ports as follows:
 - ← Skips from the current port to the first accessible port previous to it. (See *SCAN-SKIP MODE*, page 33, for information regarding accessible ports.)
 - Skips from the current port to the next accessible port.
 - ↑ Skips from the current port to the last accessible port of the previous station.
 - ↓ Skips from the current port to the first accessible port of the next station.
 - ◆ Once you are in Skip Mode, you can keep on skipping by pressing the Arrow keys. You don't have to use the hotkey invocation keys again.
 - ◆ While Skip Mode is in effect, ordinary keyboard and mouse functions are suspended - only Skip Mode compliant keystrokes can be input. You must exit Skip Mode in order to regain normal control of the console.
3. To exit Skip Mode, press **[Esc]** or **[Spacebar]**.

Hotkey Configuration Operations

Keyboard / Mouse Reset

If the keyboard or mouse ceases to function on the computer connected to the currently selected port, you can perform a keyboard / mouse reset on the computer. This function is essentially the same as unplugging and replugging the keyboard and mouse on the target computer. To perform a computer keyboard / mouse reset, key in the following hotkey combination:

1. Invoke Hotkey Mode (see page 41).
2. Press **[F5]**.

After you press [F5] you automatically exit *Hotkey* mode and regain keyboard and mouse control on the computer connected to the KVM port. If you fail to regain keyboard / mouse control on the computer after pressing [F5], perform a console keyboard and mouse reset. For more information see *Port Selection Switches*, page 9.

Hotkey Beeper Control

The Beeper (see *ACTIVATE BEEPER*, page 35) can be hotkey toggled On and Off. When the beeper is set to On, the CS1708i / CS1716i beeps when it switches ports. To toggle the Beeper, do the following:

1. Invoke Hotkey Mode (see page 41).
2. Press **[B]**

After you press **B**, the Beeper toggles On or Off. The Command Line displays *Beeper On* or *Beeper Off* for one second; then the message disappears and you automatically exit Hotkey Mode.

Toggle the Hotkey Invocation Keys

The Hotkey invocation keys (see *HOTKEY*, page 33) can be toggled between the default set ([Num Lock] + [-]), and an alternate set ([Ctrl] + [F12]). To toggle the invocation keys, do the following:

1. Invoke Hotkey Mode (see page 41).
2. Press **[H]**.

After you press [H], the command line displays *HOTKEY HAS BEEN CHANGED* for one second; then the message disappears and you automatically exit *Hotkey* mode.

Toggleing the OSD Hotkey

The *OSD Hotkey* (see *OSD HOTKEY*, page 32) can be toggled between [Scroll Lock], [Scroll Lock] and [Ctrl], [Ctrl]. To toggle the *OSD Hotkey*, do the following:

1. Invoke Hotkey Mode (see page 41).
2. Press [T].

After you press [T], the command line displays *HOTKEY HAS BEEN CHANGED* for one second; then the message disappears and you automatically exit *Hotkey* mode.

Setting the Port Operating System

A KVM port's operating system attribute can be set to match the OS used by the computer attached to the port. To set a port's operating system attribute, do the following:

1. Invoke Hotkey Mode (see page 41).
2. Press a Function key according to the information shown in the following table:

Key	Description
F1	Sets the Port OS to Win (PC Compatible)
F2	Sets the Port OS to Mac
F3	Sets the Port OS to Sun

After pressing a function key you automatically exit *Hotkey* mode.

Restore Default Values

This administrator only hotkey restores the CS1708i / CS1716i default values (see *RESTORE DEFAULT VALUES*, page 35). To restore the default values, do the following:

1. Invoke Hotkey Mode (see page 41).
2. Press [R].
3. Press [Enter].

After you press [Enter], the command line displays *RESET TO DEFAULT SETTING* for three seconds; then the message disappears and you automatically exit *Hotkey* mode.

Hotkey Summary Table

The following table summarizes Hotkey operations on the CS1708i / CS1716i:

[Num Lock] + [-] or [Ctrl] + [F12]	[A] [Enter]	Invokes <i>Auto Scan</i> mode. When <i>Auto Scan</i> mode is in effect, [P] or left-click pauses auto-scanning. When auto-scanning is paused, pressing any key or another left-click resumes auto-scanning.
	[B]	Toggles the Beeper On or Off.
	[Esc] or [Spacebar]	Exits hotkey mode.
	[F1]	Set Operating System to Windows
	[F2]	Set Operating System to Mac
	[F3]	Set Operating System to Sun
	[F5]	Performs a keyboard / mouse reset on the target computer.
	[H]	Toggles the Hotkey invocation keys.
	[Port ID] [Enter]	Switches access to the computer that corresponds to that Port ID.
	[R] [Enter]	Administrator only hotkey. It returns the switch's settings to their default values.
	[T]	Toggles the <i>OSD Hotkey</i> between [Ctrl] [Ctrl] and [Scroll Lock] [Scroll Lock].
	[←]	Invokes Skip Mode and skips from the current port to the first accessible port previous to it.
	[→]	Invokes Skip Mode and skips from the current port to the next accessible port.
	[↑]	Invokes Skip Mode and skips from the current port to the last accessible port of the previous Station.
	[↓]	Invokes Skip Mode and skips from the current port to the first accessible port of the next Station.

This Page Intentionally Left Blank

Chapter 5

Browser Login

Overview

A graphical browser-based interface governs remote CS1708i / CS1716i administration as well as user configuration and port switching operations. The switch can be accessed either via a Windows-based viewer or a Java-based viewer. Before gaining access, you must first log in via an Internet browser to connect to the CS1708i / CS1716i.

Note: The Windows-based viewer is not available to non-windows platforms.

Logging In

To log in from an Internet browser, do the following:

1. Open your browser and specify the IP address of the CS1708i / CS1716i you want to access in the browser's URL location bar.

Note: 1. For security purposes, a login string may have been set by the administrator. If so, you must include a forward slash and the login string along with the IP address when you log in. For example:

```
192.168.0.100/CS1716i
```

If you don't know the IP address and login string, ask your Administrator.

2. If you are the administrator, and are logging in for the first time, the various ways to determine the CS1708i / CS1716i's IP address are described in the Appendix on page 145.
-

2. If a Security Alert dialog box appears, accept the certificate – it can be trusted. (see *Trusted Certificates*, page 151 for details.)

The CS1708i / CS1716i login page appears:



3. Provide a valid Username and Password (set by the CS1708i / CS1716i administrator – see *User Management*, page 67), then click **Login** to continue.

Note: 1. If you are the Administrator and are logging in for the first time, use the default Username: *administrator*; and the default Password: *password*. For security purposes, we strongly recommend you remove these and give yourself a unique Username and Password (see *User Management*, page 67).

2. If you supply an invalid login, the authentication routine will return this message: *Invalid Username or Password. Please try again*. If you see this message, log in again being careful with the Username and Password.
 3. If the number of invalid login attempts exceeds an amount specified by the switch's administrator, a message stating that *The page cannot be displayed*, appears and a timeout period is invoked. You must wait until the timeout period expires before you can attempt to log in again (see *Login Failure*, page 69).
-

After you have successfully logged in, the CS1708i / CS1716i Main Webpage appears:



Note: The makeup of the Main Webpage varies depending on the User type and permissions (see *User Management*, page 67). Not all of the screen elements appear for all users.

For example, the screenshot shown above depicts the type of page that an Administrator (or User with administrator permissions) would see. A typical User would not see the administration icons that appear across the top of the page, or the *Log* icon at the left of the page, and the large central area would be blank.





Main Webpage Elements

The Main page consists of user access icons arranged vertically down the left side, and administrative function icons arranged across the top.

Note: If a user doesn't have permission to perform a particular activity, the icon for that activity doesn't appear. see *User Management*, page 67, for permission details.

User Access Icons

The icons arranged down the left side perform the following functions:

Icon	Purpose
	<p>Open Windows Client: Opens the Windows Client Viewer to access the computers connected to the switch.</p> <p>Note: The Windows Client Viewer is only available when you log in using the Microsoft Internet Explorer (IE) browser.</p>
	<p>Open Java Applet: Opens the Java Applet Viewer to access the computers connected to the switch. This Viewer makes the CS1708i / CS1716i accessible to all platforms that have the Java Runtime Environment (JRE) installed.</p>
	<p>Log: All the events that take place on the CS1708i / CS1716i are recorded in a log file. If you have the proper permission (see <i>User Management</i>, page 67), clicking this icon displays the contents of the log file. The Log File is discussed in Chapter 9.</p>
	<p>Language: Click this icon to select the language that the interface displays in. Click the button in the list to make your selection. After making your choice, click Apply.</p> <p>Note: Selecting Auto causes the interface to display in the language that the browser is set to – provided it is set to one of the supported display languages, if not, the interface defaults to English).</p>
	<p>Logout: Click this icon to log out and end your CS1708i / CS1716i session.</p>

Administrative Function Icons

The icons arranged horizontally across the top of the page are linked to the administration utilities, which are used to configure the CS1708i / CS1716i. The administrative functions are discussed in Chapter 6

Chapter 6 Administration

Introduction

The administration utilities, represented by the icons located across the top of the web page, are used to configure the CS1708i / CS1716i's operating environment.



This chapter discusses each of them in turn.

-
- Note:**
1. As you make your configuration changes in each dialog box, click **Apply** to save them.
 2. Some configuration changes only take effect after a CS1708i / CS1716i reset. For those changes, a check is automatically put in the *Reset on Exit* box (see *Customization*, page 69). To have the changes take effect, log out and then log back in again.
 3. If you don't have Configuration privileges (see *User Management*, page 67), the Administration configuration icons are not available.
-

General Information

The *General Information* page is the first of the Administration pages, and provides information about the CS1708i / CS1716i's configuration.

Device Name:	CS1708i
MAC Address:	00-10-74-67-21-59
Firmware Version:	V1.3.127
IPV4 address:	10.3.56.81
IPV6 address:	fe80::210:74ff:fe67:2159

Apply

An explanation of each of the fields is given in the table below:

Field	Explanation
Device Name:	To make it easier to manage installations that have more than one CS1708i / CS1716i, each one can be given a name. To assign a name for the CS1708i / CS1716i, key in one of your choosing here (16 characters max.), then click Apply .
MAC Address:	The CS1708i / CS1716i's MAC Address displays here.
Firmware Version:	Indicates the CS1708i / CS1716i's current firmware version level. New versions of the CS1708i / CS1716i's firmware can be downloaded from our website as they become available (see <i>Firmware Upgrade</i> , page 72). You can reference this number to see if there are newer versions available on the website.
IPv4 address	The CS1708i / CS1716i's IPV4 address is displayed here. The IPV4 address is configured from the Network page, see <i>IPv4 Configuration</i> , page 56 for details.
IPv6 address	The CS1708i / CS1716i's IPV6 address is displayed here. The IPV6 address is configured from the Network page, see <i>IPv6 Configuration</i> , page 57 for details.

Network

The Network dialog is used to specify the CS1708i / CS1716i's network environment.

Access Ports

If a firewall is being used, the Administrator can specify the port numbers that the firewall will allow and the firewall accordingly. If a port other than the default is set, users must specify the port number as part of the IP address when they log in. If an invalid port number is specified, the switch will not be found.

An explanation of the fields is given in the table below:

Field	Explanation
Program	This is the port number that must be specified when connecting to the CS1708i / CS1716i from the Win Client or Java Client AP programs. Valid entries are from 1–65535. The default is 9000.
HTTP	The port number for a browser login. Valid entries are from 1–65535. The default is 80.
HTTPS	The port number for a secure browser login. Valid entries are from 1–65535. The default is 443.

- Note:**
1. If there is no firewall (on an Intranet, for example), it doesn't matter what these numbers are set to, since they have no effect.
 2. The service ports cannot have the same value. You must set a different value for each one.

IPv4 Configuration

IPv4 is the traditional method of specifying IP addresses. The CS1708i / CS1716i can either have its IP address assigned dynamically (DHCP), or it can be given a fixed IP address.

- ♦ For dynamic IP address assignment, select the *Obtain an IP address automatically*, radio button.
- ♦ To specify a fixed IP address, select the *Set IP address manually*, radio button and fill in the IP address, Subnet Mask, and Default Gateway fields with settings appropriate for your network.

Note: If the CS1708i / CS1716i is on a network that uses DHCP to assign network addresses, and you need to ascertain its IP address, see *IP Address Determination*, page 145, for information.

DNS Server

The CS1708i / CS1716i can either have its DNS server address assigned automatically, or a fixed address can be specified.

- ♦ For automatic DNS Server address assignment, select the *Obtain DNS server address automatically*, radio button.
- ♦ To specify a fixed address, select the *Use the following DNS server address*, radio button and fill in the required information.

Note: Specifying an alternate DNS Server address is optional.

IPv6 Configuration

IPv6 is the new (128-bit) format for specifying IP addresses. (See *IPv6*, page 147.) The CS1708i / CS1716i can either have its IPv6 address assigned dynamically (DHCP), or it can be given a fixed IP address.

- ♦ For dynamic IP address assignment, select the *Obtain an IP address automatically*, radio button.
- ♦ To specify a fixed IP address, select the *Set IP address manually*, radio button and fill in the IP address, Prefix Length, and Default Gateway fields with settings appropriate for your network.

Note: If the CS1708i / CS1716i is on a network that uses DHCP to assign network addresses, and you need to ascertain its IP address, see *IP Address Determination*, page 145, for information.

DNS Server

The CS1708i / CS1716i can either have its DNS server address assigned automatically, or a fixed address can be specified.

- ♦ For automatic DNS Server address assignment, select the *Obtain DNS server address automatically*, radio button.
- ♦ To specify a fixed address, select the *Use the following DNS server address*, radio button and fill in the required information.

Note: Specifying an alternate DNS Server address is optional.

IP Installer Settings

The IP Installer is an external Windows-based utility for assigning IP addresses to the CS1708i / CS1716i.

Click one of the radio buttons to select *Enable*, *View Only*, or *Disable* for the IP Installer utility. See *IP Installer*, page 145 for details.

-
- Note:**
1. If you select *View Only*, you will be able to see the CS1708i / CS1716i in the IP Installer's Device List, but you will not be able to change the IP address.
 2. For security, we strongly recommend that you set this to *View Only* or *Disable* after using it.
-

Finishing Up

After making any network changes, be sure *Reset on exit* on the *Customization* page (see *Customization*, page 69) has been enabled (there is a check in the checkbox), before logging out. This allows network changes to take effect without having to power the CS1708i / CS1716i off and on.

Security

The Security page controls access to the CS1708i / CS1716i.

The screenshot shows a window titled "User Station Filters" with a light gray background. At the top, there are two sections. The first section is for IP filtering, with a checkbox labeled "IP Filter Enable" and two radio buttons labeled "Include" and "Exclude". Below this is a large empty rectangular box for listing filters. To the right of this box are three buttons: "Add", "Modify", and "Delete". The second section is for MAC filtering, with a checkbox labeled "MAC Filter Enable" and two radio buttons labeled "Include" and "Exclude". Below this is another large empty rectangular box for listing filters. To the right of this box are three buttons: "Add", "Modify", and "Delete". At the bottom of the window, there is a text input field labeled "Login String:" and an "Apply" button.

If any *User Station Filters* have been configured, they appear in the IP Filter and/or MAC Filter list boxes.

IP and MAC Filters control access to the CS1708i / CS1716i based on the IP and/or MAC addresses of the computers attempting to connect. A maximum of 100 IP filters and 100 MAC filters are allowed.

To enable IP and/or MAC filtering, **Click** to put a check mark in the *IP Filter Enable* and/or *MAC Filter Enable* checkbox.

- ◆ If the *Include* button is checked, all the addresses within the filter range are allowed access; all other addresses are denied access.
- ◆ If the *Exclude* button is checked, all the addresses within the filter range are denied access; all other addresses are allowed access.

Adding Filters

To add an IP filter, do the following:

1. Click **Add**. A dialog box similar to the one below appears:

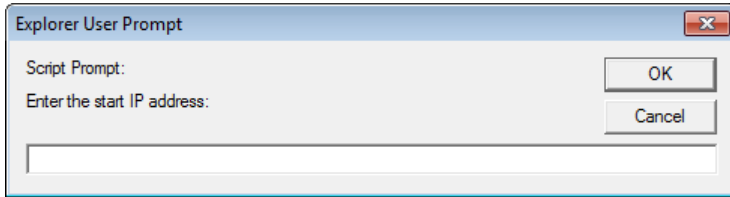

2. Specify the filter address in the dialog box (for example, 192.168.0.200), then click **OK**.

A second dialog box, similar to the one below, appears:

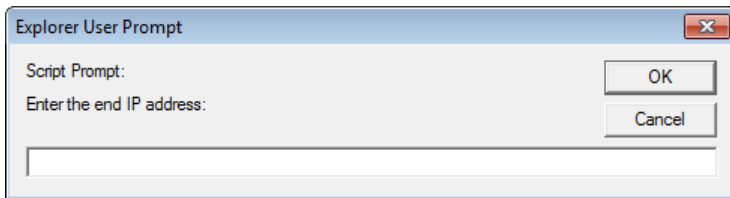

3. To filter a single IP address, key in the same address as the start IP. To filter a continuous range of addresses, key in the end number of the range (for example, 192.168.0.225).
4. After filling in the address, click **OK**.

Repeat these steps for any additional IP addresses you want to filter.

To add a MAC filter, do the following:

1. Click **Add**. A dialog box similar to the one below appears:

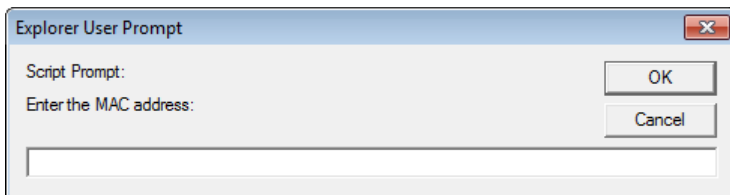

2. Specify the MAC address in the dialog box (for example, 001074670000), then click **OK**.

Repeat these steps for any additional MAC addresses you want to filter.

IP Filter / MAC Filter Conflict

If there is a conflict between an IP filter and a MAC filter – for example, where a computer’s IP address is allowed by the IP filter but it’s MAC address is excluded by the MAC filter – then that computer’s access is blocked.

In other words, if either filter blocks a computer, then the computer is blocked, no matter what the other filter is set to.

Modifying Filters

To modify a filter, select it in the IP Filter or MAC Filter list box and click **Modify**. The Modify dialog box is similar to the Add dialog box. When it comes up, simply delete the old address(es) and replace it with the new one(s).

Deleting Filters

To delete a filter, select it in the IP Filter or MAC Filter list box and click **Delete**.

Login String

The *Login String* lets the Administrator specify a login string that users must include (in addition to the IP address) when they access the CS1708i / CS1716i with a browser. For example:

```
192.168.0.126/CS1716i
```

-
- Note:**
1. There must be a forward slash between the IP address and the string.
 2. If no login string is specified here, anyone will be able to access the CS1708i / CS1716i login page using the IP address alone. This makes your installation less secure.
-

For security purposes, we recommend that you change this string occasionally.

ANMS

The Advanced Network Management Settings page allows you to set up login authentication and authorization management from external sources. It is divided into several sections, each of which is described in the sections that follow.

The screenshot displays the ANMS configuration interface, organized into four distinct sections, each with a black header bar. The background is a light gray with a subtle grid pattern.

- RADIUS Settings:** Features an "Enable" checkbox (unchecked). Below it are four input fields: "Primary RADIUS Server IP:" (empty), "Alternate RADIUS Server IP:" (empty), "Timeout (seconds):" (value: 5), and "Shared Secret (at least 6 characters):" (empty). To the right of the IP fields are "Port:" dropdown menus, both set to "1812". A "Retries:" dropdown menu is set to "3".
- CC Management Settings:** Features an "Enable" checkbox (checked). Below it are two input fields: "CC Server IP:" (empty) and "Port:" (value: 0).
- LDAP Authentication Settings:** Features an "Enable" checkbox (unchecked). Below it are three radio buttons: "LDAP" (selected), "LDAPS" (unselected), and "Enable Authorization" (unselected). Below these are six input fields: "LDAP Server IP:" (empty), "LDAP Admin DN:" (empty), "LDAP Admin Password:" (empty), "Search DN:" (empty), "Admin Group:" (empty), and "Timeout (seconds):" (value: 10). To the right of the "LDAP Server IP:" field is a "Port:" dropdown menu set to "636".
- Log Server Settings:** Features two input fields: "Log Server MAC Address:" (value: 000000000000) and "Port:" (value: 9001).

An "Apply" button is located at the bottom right of the configuration area.

RADIUS Settings

To allow authentication and authorization for the CS1708i / CS1716i through a RADIUS server, do the following:

1. Check **Enable**.
2. Fill in the IP addresses and port numbers for the Preferred and Alternate RADIUS servers.
3. In the *Timeout* field, set the time in seconds that the CS1708i / CS1716i waits for a RADIUS server reply before it times out.
4. In the *Retries* field, set the number of allowed RADIUS retries.
5. In the *Shared Secret* field, key in the character string that you want to use for authentication between the CS1708i / CS1716i and the RADIUS Server.
6. On the RADIUS server, set the access rights for each user according to the information in the table, below:

Character	Meaning
C	Grants the user administrator privileges, allowing the user to configure the system.
W	Allows the user to access the system via the Windows Client program.
J	Allows the user to access the system via the Java applet.
L	Allows the user to access log information via the user's browser.
V	Limits the user's access to only viewing the video display.
PN / SN	Denies the user access to port(s) / station(s)
PV / SV	Limits the user's access to only viewing port(s) / station(s)
PF / SF	Allows the user full access to all ports / all stations.

Note: Characters are not case sensitive and are comma delimited.

RADIUS Examples

RADIUS Server access rights examples are given in the table, below:

String	Meaning
c,w	User has administrator privileges; user can access the system via the Windows Client.
w,j,l	User can access the system via the Windows Client; user can access the system via the Java Applet; user can access log information via the user's browser.
pn/0102	User cannot access station 01, port 02
pf/a	User can access all ports
sv/2	User can only view station 02

CC Management Settings

To allow authorization for the CS1708i / CS1716i through a CC (Control Center) server, check *Enable* and fill in the CC Server's IP address and the port that it listens on in the appropriate fields.

LDAP Settings

The CS1708i / CS1716i allows log in authentication and authorization through external programs. To allow authentication and authorization via LDAP or LDAPS, the Active Directory's LDAP *Schema* must be extended so that an extended attribute name for the CS1708i / CS1716i – **CS1716i-accessRight** – is added as an optional attribute to the *person* class.

Note: *Authentication* refers to determining the authenticity of the person logging in; *authorization* refers to assigning permission to use the device's various functions.

In order to configure the LDAP server, you will have to complete the following procedures: 1) Install the Windows Server Support Tools; 2) Install the Active Directory Schema Snap-in; and 3) Extend and Update the Active Directory Schema.

To allow authentication and authorization for the CS1708i / CS1716i via LDAP / LDAPS, refer to the information in the table on the following page. For more information, please see the ATEN website at www.aten.com.

Item	Action
Enable	Put a check in the <i>Enable</i> checkbox to allow LDAP / LDAPS authentication and authorization.
LDAP / LDAPS	Click a radio button to specify whether to use LDAP or LDAPS.
Enable Authorization	<p>Select whether to enable <i>Enable Authorization</i>, or not.</p> <ol style="list-style-type: none"> 1. If enabled (the box is checked), the LDAP / LDAPS server directly returns a 'permission' attribute and authorization for the user that is logging in. With this selection the LDAP schema must be extended. 2. If not enabled (no check in the box), the result the server returns indicates whether the user that is logging in belongs to the 'CS1708i / CS1716i Admin Group'. If the result is 'yes' the user has full access rights; if the result is 'no', the user only has limited access rights. <p>Note: Consult the LDAP / LDAPS administrator to ascertain whether to enable the <i>Enable Authorization</i> function, or not.</p>
LDAP Server IP and Port	Fill in the IP address and port number for the LDAP or LDAPS server. For LDAP, the default port number is 389; for LDAPS, the default port number is 636.
Timeout	Set the time in seconds that the CS1708i / CS1716i waits for an LDAP or LDAPS server reply before it times out.
LDAP Administrator DN	<p>Consult the LDAP / LDAPS administrator to ascertain the appropriate entry for this field. For example, the entry might look like this:</p> <p>cn=LDAPAdmin,ou=cs1716i,dc=aten,dc=com</p>
LDAP Administrator Password	Key in the LDAP administrator's password.
Search DN	<p>Set the distinguished name of the search base. This is the domain name where the search starts for user names.</p> <p>If <i>Enable Authorization</i> is not checked, this field must include the entry where the CS1708i / CS1716i <i>Admin Group</i> is created. Consult the LDAP / LDAPS administrator to ascertain the appropriate value.</p>
Admin Group	<p>Key in the Group Name for CS1708i / CS1716i administrator users.</p> <p>If <i>Enable Authorization</i> is not checked, this field is used to authorize users that are logging in. If a user is in this group, the user receives full access rights. If a user is not in this group, the user only receives limited access rights. Consult the LDAP / LDAPS administrator to ascertain the appropriate value.</p>

Log Server

Important transactions that occur on the CS1708i / CS1716i, such as logins and internal status messages, are kept in an automatically generated log file

- ◆ Specify the MAC address of the computer that the Log Server runs on in the *MAC address* field.
- ◆ Specify the port used by the computer that the Log Server runs on to listen for log details in the *Port* field. The valid port range is 1–65535. The default port number is 9001.

Note: The port number must different than the one used for the *Program* port (see *HTTPS*, page 55).

See Chapter 10, **The Log Server**, for details on setting up the log server. The Log File is discussed on page 111.

User Management

The User Management page is used to create and manage user profiles. Up to 64 user profiles can be established.

- ◆ To add a user profile, fill in the information asked for in the right panel, then click **Add**. The new user's name appears in the left panel.
- ◆ To delete a user profile, select it from the names displayed in the left panel, and click **Remove**. The user's name is removed from the panel.
- ◆ To modify a user profile, first select it from the list in the left panel; change the information that appears in the right panel; then click **Update**.

Note: The user's password is not displayed – the *Password* and *Confirm password* fields are blank. If you do not want to change the user's password, simply leave the two fields as is. If you do want to change the user's password, key the new password in the *Password* and *Confirm password* fields.

- ◆ The *Admin* and *User* radio buttons select automatically configured permissions. If you wish to modify these permissions, choose the *Select* radio button, then specify the permissions individually.

(Continues on next page.)

(Continued from previous page.)

An explanation of the profile items is given in the table below:

Item	Explanation
Username	A minimum of 6 and a maximum of 16 characters is allowed.
Password	A minimum of 6 and a maximum of 16 characters is allowed.
Confirm Password	To be sure there is no mistake in the password you are asked to enter it again. The two entries must match.
Description	Additional information about the user that you may wish to include.
Permissions	<p>Click to place/remove a check mark next to an item to grant/withhold access to that aspect of the CS1708i / CS1716i's operation.</p> <p>Win Client: Checking <i>Win Client</i> allows a user to access the CS1708i / CS1716i via the Windows Client software.</p> <p>Java Client: Checking <i>Java Client</i> allows a user to access the CS1708i / CS1716i via the Java Client software.</p> <p>Configure: Checking <i>Configure</i> gives a user Administrator privileges, and allows the user to set up and modify the CS1708i / CS1716i's operating environment.</p> <p>Log: Checking <i>Log</i> allows a user to view the contents of the log file.</p>

- ◆ The **Reset** button clears all the information shown in the right panel.
- ◆ When you have made all your changes, click **Apply**.

Customization

The Customization page allows the Administrator to set miscellaneous operational parameters for the CS1708i / CS1716i.

The screenshot shows a configuration window titled "Client Timeout Control" with several sections:

- Client Timeout Control:** A text input field for "Timeout" is set to "0" with the unit "minutes".
- Login Failure:** Two text input fields: "Allowed" is set to "5" and "Timeout" is set to "3", both with the unit "minutes".
- Working Mode:** Four checked checkboxes: "Enable ICMP", "Enable Device List", "Enable Browser", and "Enable Multiuser". One unchecked checkbox: "Force All to Grayscale".
- Mouse Sync Mode:** Two radio buttons: "Automatic" (unchecked) and "Manual" (checked).
- Reset:** One unchecked checkbox: "Reset on Exit".

At the bottom, there are two buttons: "Reset Default Values" and "Clear Port Names", and an "Apply" button in the bottom right corner.

Timeout

If there is no user input for the amount of time specified here, the user is automatically logged out, and must log in again before the CS1708i / CS1716i can be accessed. The default is 0, which means that the Timeout function is disabled.

Login Failure

- ◆ **Allowed** sets the number of consecutive failed login attempts that are permitted from a remote computer. The default is 5 times.
- ◆ **Timeout** sets the amount of time a remote computer must wait before attempting to login again after it has exceeded the number of allowed failures. The default is 3 minutes.

Working Mode

The Working Mode parameters are explained in the table below:

Parameter	Explanation
Enable ICMP	If <i>ICMP</i> is enabled , the CS1708i / CS1716i can be pinged and an IP address can be assigned with the ARP command. If it is not enabled, the device cannot be pinged, nor can it be assigned an IP address with the ARP command. The default is Enabled.
Enable Device List	If this parameter is enabled , the device will show up in the list of local CS1708i / CS1716i units on the AP Windows Client Connection screen (see <i>Starting Up</i> , page 122). If it is not enabled, it will not show up. The default is Enabled.
Force All to Grayscale	If <i>Force All to Grayscale</i> is enabled , the remote display for all users is changed to grayscale. This can speed up I/O transfer in low bandwidth situations. The default is Disabled.
Enable Browser	If <i>Enable Browser</i> is enabled , browser access to the switch is permitted. If browser access is not enabled, users must use either the WinClient AP or Java Client AP program to access the switch (see <i>AP Operation</i> , page 121). The default is Enabled.
Enable Multiuser	If this parameter is enabled , more than one user can log into the CS1708i / CS1716i at the same time. The default is Enabled.

Mouse Sync Mode

Determines how the local and remote mouse pointer movement becomes synchronized

Automatic

Selecting *Automatic* enables Mouse DynaSync™, which provides automatic locked-in synching of the local and remote pointers – eliminating the need to constantly resync the two movements manually.

Note: If *Automatic* is selected, all computers connected to the switch must use USB Adapter Cables. Otherwise, the mouse pointer will not move.

Manual

If Automatic syncing isn't able to keep the pointers in sync, selecting *Manual* provides you with a number of methods to bring them back into sync:

- ◆ Perform a video and mouse auto sync by clicking the *Video Settings* icon on the Control Panel (see page 77).
- ◆ Perform an *Auto Sync* with the *Video Adjustment* function (see *The Control Panel*, page 77).
- ◆ Invoke the *Adjust Mouse* function with the *Adjust Mouse* hotkeys (see *Adjust mouse*, page 79, for details).
- ◆ Move the pointer into all 4 corners of the screen (in any order).

Note: If you continue to have sync problems, you should set the mouse speed and acceleration settings on each problematic server. See *Additional Mouse Synchronization Procedures*, page 149, for instructions.

Reset

The functions performed by these parameters are explained in the table, below:

Parameter	Explanation
Reset on Exit	Place a check here to have the switch reset itself and implement all the new settings when you log out. Following the reset, wait approximately 30 to 60 seconds before logging back in. For network IP address settings changes the check box is automatically selected and the switch will reset when you log out. Clearing the check mark before logging out will cause the new IP settings to be ignored and the original IP address settings will remain in effect. Note: Even though the new IP information is ignored, it still remains in the field. Therefore, the next time you log in the checkbox will be selected and the next time that the switch resets the IP settings that you thought you discarded will be saved. To avoid this problem, you should be sure that the IP settings that appear in the field are the ones you want to save.
Reset Default Values	This function undoes all changes that have been made to the switch (except for the Port Names), and returns the parameters to their original factory default settings.
Clear Port Names	This function removes the names that have been assigned to the ports settings (see <i>Port Names</i> , page 88).

Maintenance

The *Maintenance* page allows the Administrator to upgrade the CS1708i / CS1716i's firmware, and to backup and restore the CS1708i / CS1716i's configuration settings, user accounts, and port names.

The screenshot displays a web interface with three main sections:

- Firmware Upgrade:** Contains a text input field for "Firmware File:" with a "Browse..." button to its right, and an "Upload" button below it.
- Backup Configuration / User Accounts:** Features a "Password:" input field, followed by four radio buttons: "Backup Configuration" (selected), "Backup User Accounts", "Backup Port Names", and "Backup All". A "Save" button is positioned below the radio buttons.
- Restore Configuration / User Accounts:** Includes a "Password:" input field, a "Restore File:" input field with a "Browse..." button to its right, and a "Restore" button below.

Firmware Upgrade

As new versions of the CS1708i / CS1716i firmware become available, they can be downloaded from our website. Check the website regularly to find the latest information and packages.

Note: The firmware upgrade described in this section refers to the CS1708i / CS1716i's icard firmware. Each time you perform this upgrade, you must also upgrade the mainboard firmware (see Chapter 12, *The Firmware Upgrade Utility*).

To upgrade the icard firmware, do the following:

1. Download the new firmware file to your computer.
2. Open your browser; log in to the CS1708i / CS1716i; and click the *Maintenance* icon.
3. Click **Browse** (to the right of the *Firmware File* text input box); navigate to the directory that the new firmware file is in and select the file.
4. Click **Upload**.
5. After the upload completes, and a message appears on the screen to inform you that the operations succeeded, log out to exit and reset the CS1708i / CS1716i.

Note: You will need to wait a bit before logging back in.

Backup Configuration / User Accounts / Port Names

This section of the page gives you the ability to back up the CS1708i / CS1716i's configuration, user profile information, and port names.

To perform a backup, do the following:

1. In the *Password* field, key in a password for the file.

Note: Make a note of the password, since you will need it to be able to perform restore operations with the file.

2. Select whether to backup the configuration information, user account information, port names, or backup all.
3. Click **Save**.
4. When the browser asks what you want to do with the file, select *Save to disk*; then save it in a convenient location.

Note: The CS1708i / CS1716i saves all its backup files as *CS1716i.conf*. If you want to save more than one backup file, simply rename the file to something convenient when you save it.

Restore Configuration / User Accounts / Port Names

Backed up Configuration information, User Accounts, and Port Names can be restored with this section of the page. Information currently configured on the CS1708i / CS1716i will be replaced with the information that you restore.

To restore a previous backup, do the following:

1. In the *Password* field, key in the same password that you used to save the backup file.
2. Click **Browse**; navigate to the file and select it.

Note: If you renamed the file, you can leave the new name. There is no need to return it to its original name.

3. Click **Restore**.

After the file is restored, a message appears to inform you that the procedure succeeded.

Chapter 7

The Windows Client Viewer

Starting Up

The Windows Client Viewer is only available when you log in using the Microsoft Internet Explorer (IE) browser. After you log in (see *Logging In*, page 49), click the *Open Windows Client* icon at the left of the page.

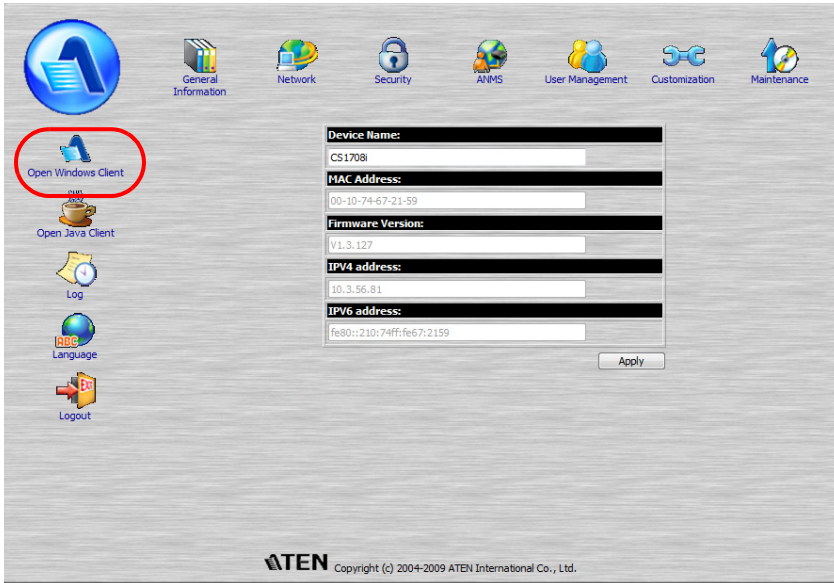

(Continues on next page.)

(Continued from previous page.)

A second or two after you click the *Open Windows Client* link, you connect to the switch:

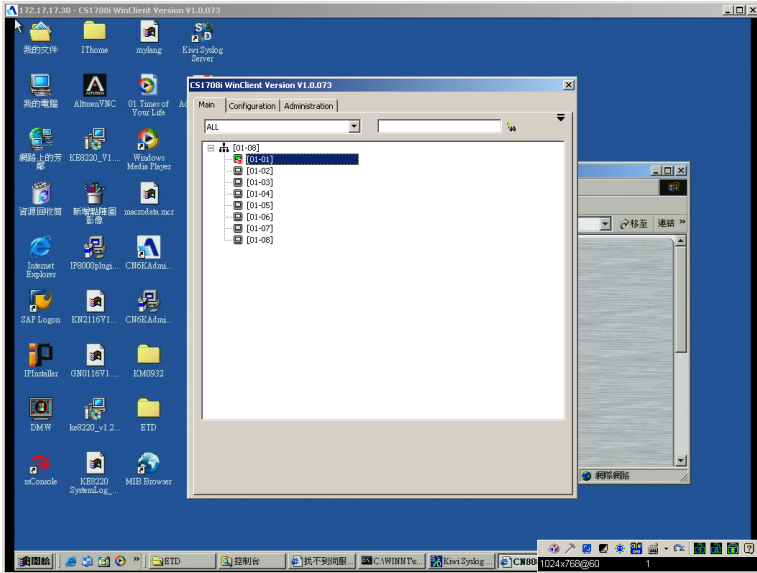

The CS1708i / CS1716i's GUI comes up with the *Main* page displayed in the center of the screen and a *Control Panel* displayed at the lower right. The GUI consists of three pages – Main, Configuration, and Administration. The Main page is what you use to switch ports and access the servers connected to them.

- Note:**
1. If another user is using the GUI, it does not appear. A message informing you that it is in use by another user appears, instead – you must wait until the other user finishes with it before it becomes available to you.
 2. The *Administration* tab is not available for users who don't have administration permission.
 3. The display of the server connected to the highlighted port in the GUI Main page may appear behind the GUI, but you can't work on it at this time. You can only work on it after accessing it with the GUI.

After switching to a port, you can work on the remote system via the screen display on your monitor just as if it were your local system. You can maximize the window, drag the borders to resize the window; or use the scrollbars to move around the screen.

The next section discusses the Control Panel, the GUI is discussed beginning on page 85.





The Control Panel





The control panel consists of an icon bar at the top, with a text bar below it. The text bars display the video resolution of the accessed device at the remote location at the left; and the number of currently logged in users in the center:



Note: To place the control panel anywhere on the screen, move the mouse pointer over the text bar area and drag the panel to the new position.

The functions that the icons perform are described in the table below:

Icon	Function
	Click to bring up the Hotkey Setup dialog box (see <i>Hotkey Setup</i> , page 79 for details).
	Click to bring up the Video Settings dialog box (see <i>Video Settings</i> , page 81).
	Click to perform a video and mouse auto sync operation. It is the same as clicking the AutoSync button in the <i>Video Settings</i> dialog box (see <i>Video Settings</i> , page 81).
	Click to toggle the remote display between color and grayscale.
	Click to bring up the Message Board (see <i>The Message Board</i> , page 82).

Icon	Function
	Click to send a <i>Ctrl+Alt+Del</i> signal to the remote system.
	Click the keyboard to bring up the on-screen keyboard. Click the arrowhead to bring up the list of available keyboard languages (see <i>The On-Screen Keyboard</i> , page 84).
	Click to exit the remote view.
	<p>These icons show the Num Lock, Caps Lock, and Scroll Lock status of the remote computer.</p> <ul style="list-style-type: none">◆ When the lock state is <i>On</i>, the LED is bright green and the lock hasp is closed.◆ When the lock state is <i>Off</i>, the LED is dull green and the lock hasp is open. <p>Click on the icon to toggle the status.</p> <p>Note: When you first connect, the LED display may not be accurate. To be sure, click on the LEDs to set them.</p>
	Click to display information about the Windows Client version.



Hotkey Setup

Various configuration actions related to the keyboard, video, and mouse can be performed via hotkey combinations. The actions performed by the Hotkeys are listed at the left of the panel; the hotkeys that invoke them are shown to the right.

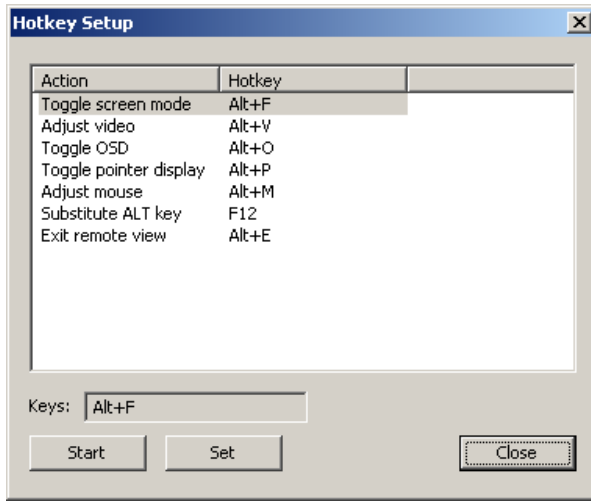

An explanation of the Hotkey actions is given in the table below:

Action	Explanation
Toggle screen mode	Toggles the screen display between full screen and windowed modes.
Adjust Video	Brings up the Video Settings dialog box (see <i>Video Settings</i> , page 81).
Toggle OSD	Toggles the Control Panel Off and On.
Toggle pointer display	If you find the display of the two mouse pointers (local and remote) to be confusing or annoying, you can use this function to hide the non-functioning pointer. Since this function is a toggle - use the hotkeys again to bring the pointer display back to its original configuration.
Adjust mouse	This utility synchronizes the local and remote mouse pointers. After invoking this utility, simply click the local mouse pointer on top of the remote mouse pointer. Note: If you still have synchronization problems following this procedure, see <i>Mouse Sync Mode</i> , page 70, and <i>Additional Mouse Synchronization Procedures</i> , page 149 for further steps you can take to resolve the problem.

Action	Explanation
Substitute Alt key	Although all other keyboard input is captured and sent to the remote system, [Alt + Tab] and [Ctrl + Alt + Del] work on your local computer. In order to implement their effects on the remote system, another key may be substituted for the Alt key. If you substitute the F12 key, for example, you would use [F12 + Tab] and [Ctrl + F12 + Del].
Exit remote location	Breaks the connection to the CS1708i / CS1716i and returns you to local operation.

Configuring the Hotkeys

If you find the default Hotkey combinations inconvenient, you can configure them by following these steps:

1. Highlight the Action.
2. Click **Start**
3. Key in the new combination.

The key names appear in the *Key* field as you press them.

4. Click **Set**
5. Click **Close**.



Video Settings

The *Video Settings* dialog box allows you to adjust the placement and picture quality of the remote screen display on your monitor.

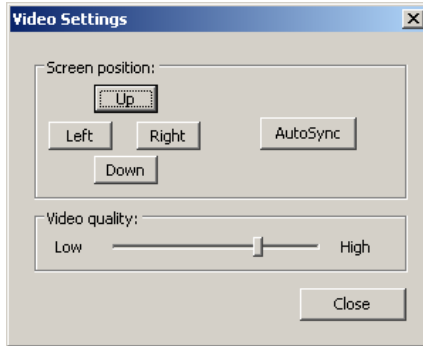

The meanings of the adjustment options are given in the table below:

Option	Usage
Screen Position	Adjust the horizontal and vertical position of the remote computer window by Clicking the Up, Down, Left, and Right buttons.
AutoSync	Click <i>AutoSync</i> to have the vertical and horizontal offset values of the remote screen detected and automatically synchronized with the local screen. Note: 1. If the local and remote mouse pointers are out of sync, in most cases, performing this function will bring them back into sync. 2. This function works best with a bright screen. 3. If you are not satisfied with the results, use the Screen Position arrows to position the remote display manually.
Video Quality	Drag the slider bar to adjust the overall Video Quality. The larger the value, the clearer the picture and the more video data goes through the network. Depending on the network bandwidth, a high value may adversely effect response time.





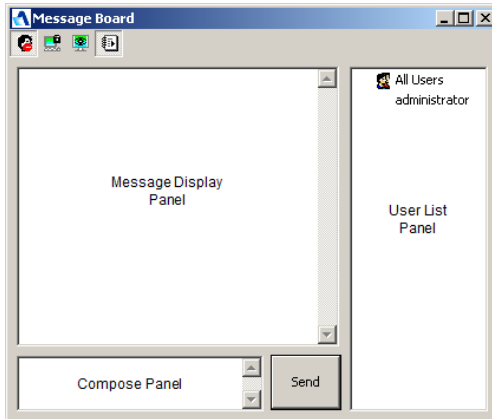

The Message Board

To alleviate the possibility of access conflicts resulting from multiple user logins, the CS1708i / CS1716i provides a message board that allows users to communicate with each other:



The Button Bar

The buttons on the Button Bar are toggles. Their actions are described in the table below:

Button	Action
	Enable/Disable Chat. When disabled, messages posted to the board are not displayed. The button is shadowed when Chat is disabled. The icon displays next to the user's name in the User List panel when the user has disabled Chat.
	Occupy/Release Keyboard/Video/Mouse. When more than one user is logged in, this button allows a user to occupy the KVM. When a user occupies the KVM, other users cannot see the video, and cannot input keyboard or mouse data. The button is shadowed when the KVM is occupied. The icon displays next to the user's name in the User List panel when the user has occupied the KVM.
	Occupy/Release Keyboard/Mouse. When more than one user is logged in, this button allows a user to occupy the KM. a user occupies the KM, other users can see the video, but cannot input keyboard or mouse data. The button is shadowed when the KM is occupied. The icon displays next to the user's name in the User List panel when the user has occupied the KM.
	Show/Hide User List. When you Hide the User List, the User List panel closes. The button is shadowed when the User List is open.

Message Display Panel

Messages that users post to the board - as well as system messages - display in this panel. If you disable Chat, however, messages that get posted to the board won't appear.

Compose Panel

Key in the messages that you want to post to the board in this panel. Click **Send**, or press [**Enter**] to post the message to the board.

User List Panel

The names of all the logged in users are listed in this panel.

- ◆ By default, messages are posted to all users. To post a message to one individual user, select the user's name before sending your message.
- ◆ If a user's name is selected, and you want to post a message to all users, select All Users before sending your message.
- ◆ If a user has disabled Chat, its icon displays before the user's name to indicate so.
- ◆ If a user has occupied the KVM or the KM, its icon displays before the user's name to indicate so.

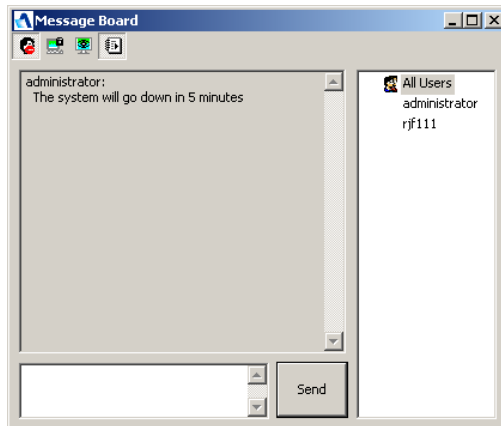



The On-Screen Keyboard

The CS1708i / CS1716i supports an on-screen keyboard, available in multiple languages, with all the standard keys for each supported language. Click this icon to pop up the on-screen keyboard:



One of the major advantages of the on-screen keyboard is that if the keyboard languages of the remote and local systems aren't the same, you don't have to change the configuration settings for either system. The user just has to bring up the on-screen keyboard; select the language used by the computer on the port he is accessing; and use the on-screen keyboard to communicate with it.

Note: You must use your mouse to click on the keys. You cannot use your actual keyboard.

Changing Languages

To change languages, do the following:

1. Click the down arrowhead next to the keyboard icon to drop down the language list.

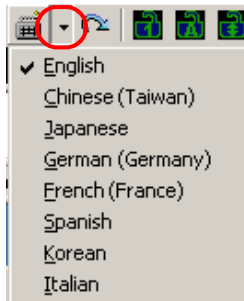

2. Select the new language from the list.

The Main Page

This page lists all of the CS1708i / CS1716i's ports and governs port access. Selecting a port and double clicking it switches you to the device on that port.

Note: The administrator selects which ports are accessible to each user with the *User Management* function (see page 98 for details).

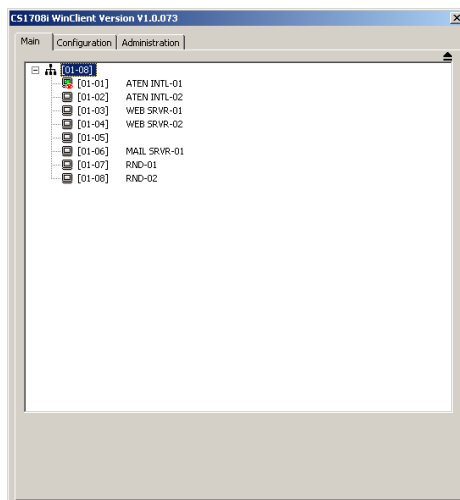

- ◆ The GUI uses a tree view. To see the ports for a particular station, click the plus sign [+] in front of the Station Number. To dismiss the list, click the minus sign [-] in front of the Station Number.
- ◆ A *port icon* in the shape of a monitor displays in front of the port number. Ports that have devices connected to them that are up and running have the port icon lit in green.
- ◆ Ports that have been selected as Quick View ports (see *SET QUICK VIEW PORTS*, page 35 and *The I/O Panel*, page 105), have a red eye icon displayed with the monitor in the port icon column to indicate so.

The List Function

The List Function lets you broaden or narrow the scope of which ports the GUI displays (lists) in the Main Screen. To invoke the List Function, click the arrow at the upper right corner of the panel, or press **[F3]**:

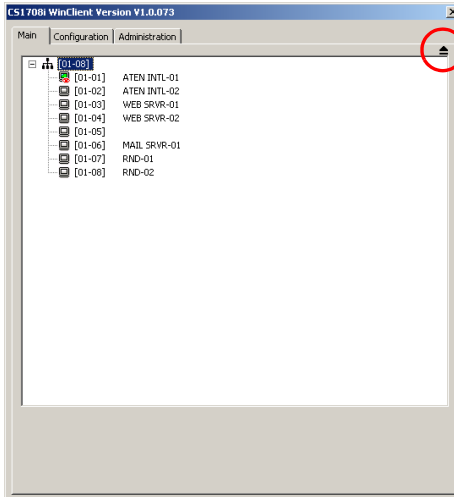

The screen changes to allow you to choose the ports that will be listed:

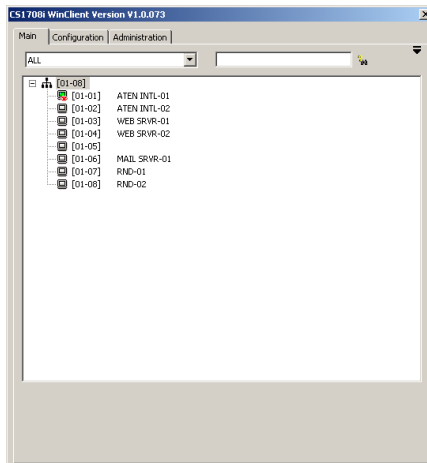

The drop down list on the left offers four fixed choices as shown in the table, below:

Choice	Meaning
All	Lists all of the ports on the installation.
Powered On	Lists only the ports that have their attached devices powered on.
Quick View	Lists only the ports that have been selected as Quick View ports (see <i>SET QUICK VIEW PORTS</i> , page 35, and <i>The I/O Panel</i> , page 105).
Quick View + Powered On	Lists only the ports that have been selected as Quick View Ports and that have their attached devices Powered On.

The text input box on the right allows you to key in a search condition so that only port names that match what you key in show up in the list, as shown in the screenshot, below:

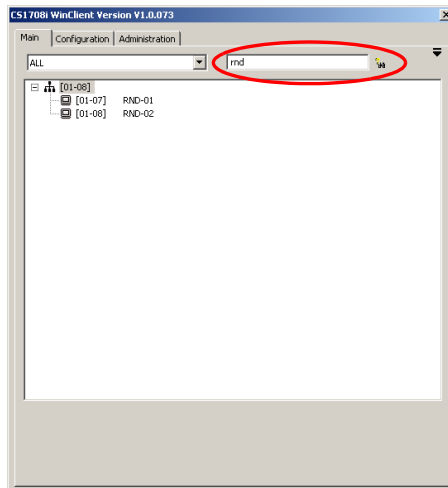

- ◆ To go back to the default view, erase the string and either click the binoculars to the right of the box, or press **[Enter]**.
- ◆ To dismiss the List function, click the arrow or press **[F3]**.

Port Names

To help remember which computer is attached to a particular port, every port can be given a name. This field allows the Administrator to create, modify, or delete port names. To configure a port name:

1. Click once on the port you want to edit, then either press [F2], or click again on the highlight bar.

Note: This is not a double click. It involves two separate clicks. A double click will switch you to the device attached to the port.

After a second or two, the bar changes to a text input box:

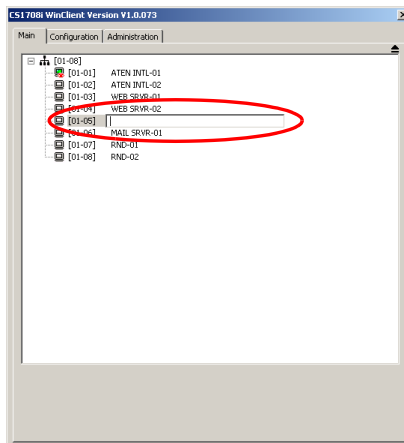

2. Key in the new Port Name, or modify/delete the old one.

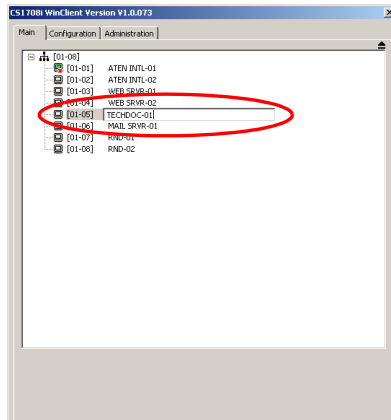

- When you have finished editing the port name, click anywhere outside of the input box to complete the operation.

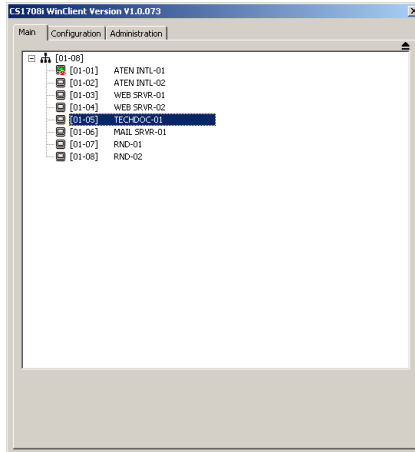

Port Operation

Once you select a port on the OSD Main Screen its screen comes up on your monitor, and your keyboard and mouse input affects the remote system.

Note: The administrator selects which ports are accessible to each user with the *User Management* function (see page 98 for details).

The Port Toolbar

The GUI provides a toolbar to help you control the CS1708i / CS1716i from within the captured port. To bring up the toolbar, tap the OSD Hotkey twice (Scroll Lock is the default OSD Hotkey). The toolbar appears at the upper left corner of the screen:



- ◆ Depending on the settings that were selected under *ID Display* (see *The Configuration Page*, page 95), the Port Number and/or the Port Name display at the right of the toolbar.
- ◆ When the toolbar displays, mouse input is confined to the toolbar area.
- ◆ Keyboard input has no effect on the computer connected to the port. To carry out operations on the computer connected to the port, close the toolbar by clicking the **X** on it, or by pressing **[Esc]**. You can also recall the GUI (see below), and select the port again.

Recalling the GUI

To dismiss the toolbar and bring back the GUI (the Main, Configuration, and Administration pages), do one of the following:

- ◆ Tap the GUI Hotkey once;
- ◆ From the toolbar click the icon that brings up the GUI (see page 91).

The Port Toolbar closes, and the main GUI display reappears.











Hotkey Summary Table

The following table presents a summary of the Hotkey actions. To set the Hotkey, see *OSD/GUI Hotkey*, page 96.

To...	When...	Do This...
Open the Toolbar	The Toolbar is not open.	Click the GUI Hotkey twice.
Open the GUI	The Toolbar is open.	Click the GUI Hotkey once.
Open the GUI	The Toolbar is not open.	Click the GUI Hotkey three times.

Toolbar Icons

The meanings of the toolbar icons are explained in the table below:

	Click to skip directly to the last port of the previous station.
	Click to skip directly to the first port of the next station.
	Click to skip directly to the first accessible port on the entire installation.
	Click to skip directly to the first accessible port previous to the current one.
	Click to begin Auto Scan Mode. The CS1708i / CS1716i automatically switches among the ports that were selected for Auto Scanning under the Configuration <i>Scan Select</i> function (see <i>Scan Select</i> , page 96). This allows you to monitor their activity without having to switch among them manually.
	Click to skip directly from the current port to the next accessible one.
	Click to skip directly from the current port to the to the last accessible port on the entire installation.
	Click to recall the GUI.
	Click to invoke <i>Panel Array Mode</i> (see page 93).
	Click to close the Port Toolbar.
	Click to log out and end the session.

Auto Scan Mode



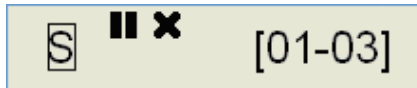

When Auto Scan Mode is invoked, the CS1708i / CS1716i automatically switches among all the ports that are accessible to the currently logged on user at regular intervals, so that the user can monitor their activity automatically. (See *Scan Select*, page 96, for information regarding accessible ports.)

While Auto Scan Mode is in effect, ordinary keyboard and mouse functions are suspended. You must exit Auto Scan Mode in order to regain normal control of the keyboard.

Under Auto Scan Mode, the normal toolbar is replaced by one that looks similar to the one below:

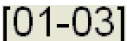

The meanings of the toolbar elements are explained in the table below:

Element	Meaning
	The  indicates the port is being accessed under Auto Scan Mode.
	Click to pause (temporarily stop) auto scanning. When auto scan is paused the icon changes to an arrowhead. Click the arrowhead to resume scanning from the point where you stopped.
	Click to exit Auto Scan Mode. The KVM focus stays on the port that had the focus when Auto Scan Mode was stopped.
	Indicates the Port ID ([Station Number - Port Number]) of the port that currently has the KVM focus.





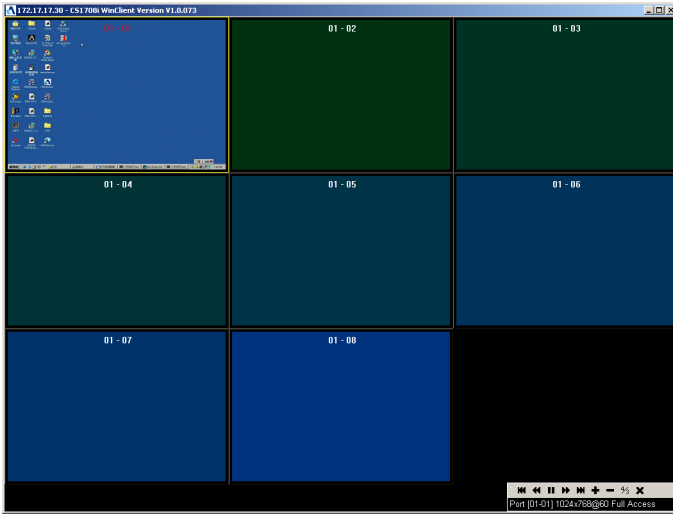



Panel Array Mode

Clicking on the Port Toolbar's *Panel* icon invokes Panel Array Mode. Under this mode the screen is divided into a grid of panels:



- ◆ Each panel represents one of the CS1708i / CS1716i's ports. The port's ID displays in the top center of the panel.
- ◆ When the Array is invoked, it scans through each of the powered-on ports at 4 second intervals.

The panel array toolbar (shown at the bottom right of the screenshot) provides shortcut navigation and control of the panel array. The meanings of the toolbar icons are explained in the table below:

Icon	Meaning
	Move back four panels.
	Move to the previous panel.
	Pause panel scanning, leaving the focus on the panel that currently has it.
	Move to the next panel.
	Move ahead four panels.
	Show More Ports: Increase the number of panels in the array.
	Show Fewer Ports: Decrease the number of panels in the array.
	Toggle between 4/3 and current aspect ratio.
	Exit Panel Array mode.

The Configuration Page

The GUI's *Configuration* page allows users to set up their own, individual, working environments. The CS1708i / CS1716i stores a separate configuration record for each user profile, and sets up the working configuration according to the *Username* that is used to log in.

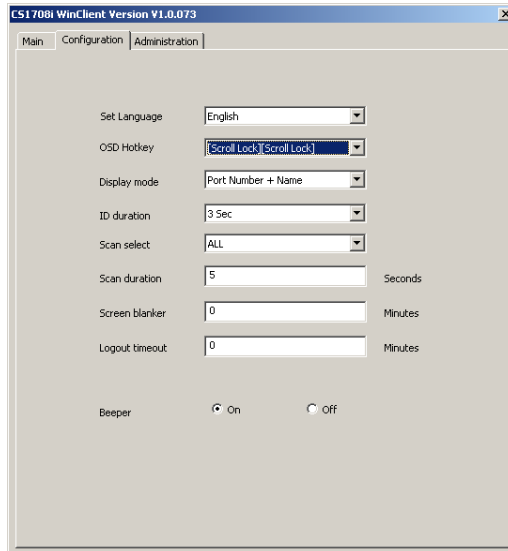

The Configuration page settings are explained in the table on the following page.

Setting	Function
Language	Selects the language that the GUI displays in. Drop down the list of supported languages to make your choice
OSD/GUI Hotkey	Selects which Hotkey controls the GUI function: [Scroll Lock] [Scroll Lock] or [Ctrl] [Ctrl] . Since the Ctrl key combination may conflict with programs running on the computers, the default is the Scroll Lock combination.
Display Mode	Selects how the Port ID is displayed: the Port Number alone (PORT NUMBER); the Port Name alone (PORT NAME); or the Port Number plus the Port Name (PORT NUMBER + PORT NAME). The default is PORT NUMBER + PORT NAME.
ID Duration	Determines how long a Port ID displays on the monitor after a port change has taken place. The choices are: 3 Seconds (default) and Always Off .
Scan Select	Selects which computers will be accessed under Auto Scan Mode (see <i>Auto Scan Mode</i> , page 92). Choices are: ALL - All the Ports which have been set Accessible (see <i>Port Access</i> , page 99); POWERED ON - Only those Ports which have been set Accessible and are Powered On; QUICK VIEW - Only those Ports which have been set Accessible and have been selected as Quick View Ports (see <i>SET QUICK VIEW PORTS</i> , page 35, and <i>The I/O Panel</i> , page 105); QUICK VIEW + POWERED ON - Only those Ports which have been set Accessible and have been selected as Quick View Ports and are Powered On. The default is ALL.
Scan Duration	Determines how long the focus dwells on each port as it cycles through the selected ports in Auto Scan Mode (see <i>Auto Scan Mode</i> , page 92). Key in a value from 0 – 255 seconds. The default is 10 seconds; a setting of 0 disables the Scan function. Note: When using Auto Scan from a remote console, the Scan Duration must be at least 5 seconds to compensate for signal delay.
Screen Blanker	If there is no input from the console for the amount of time set with this function, the screen is blanked. Key in a value from 0–30 minutes. A setting of 0 disables this function. The default is 0 (disabled).
Logout Timeout	If there is no Operator input for the amount of time set with this function, the Operator is automatically logged out. A login is necessary before the CS1708i / CS1716i can be accessed again. Enter a value from 0 – 180 minutes. The default is 30 minutes. 0 disables the function.
Beeper	When set to ON , the beeper sounds whenever the port is switched, when activating the Auto Scan function (see <i>Auto Scan Mode</i> , page 92), or when an invalid entry is made on an OSD menu. The default is ON.

The Administration Page

Each of the administrative functions is represented by an icon at the left of the page. Clicking the icon brings up its associated dialog box. When the Administration page first comes up the General page is displayed:

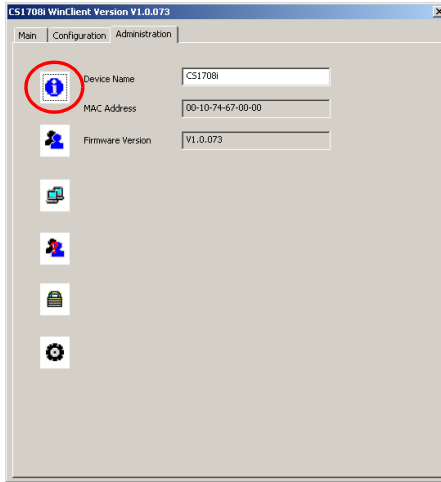

Note: This page is not available for users who don't have administration permission.

General Information

The General Information page presents three items of information. This is the same information that displays after you log in from a browser, or when you click the *General Information* icon at the top left of the browser main page. The meaning of these items is described in the table, below:

Item	Meaning
Device Name	This field lets you give the switch a unique name. This can be convenient when you need to differentiate among several devices in multi station installations. Click in the field to key in the name.
MAC Address	This item displays the CS1708i / CS1716i's MAC address.
Firmware Ver	This item displays the current firmware version number. You can reference it to see if there are newer versions available on the Altusen website.

User Management

The User Management dialogs are used to create and manage user profiles. Up to 64 user profiles can be established. Up to 32 users can log in concurrently.

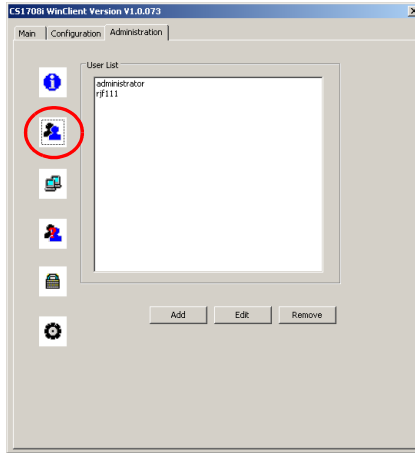

- ◆ To delete a user profile, select it in the list box, and click **Remove**.
- ◆ To modify a user profile, select it and click **Edit**.
- ◆ To add a user, click **New**.

If you choose *Edit* or *New*, a dialog box similar to the one below appears:

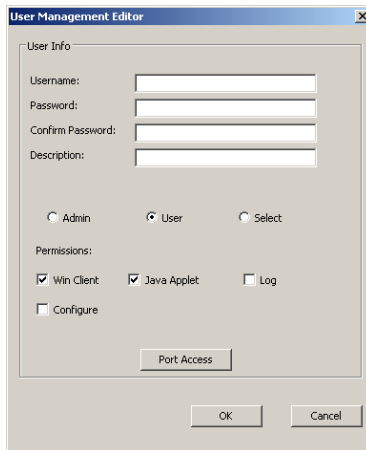

With the exception of the *Port Access* button, the information required for this dialog box is the same as that described in the *Administration* chapter – see page 67 for details.

Port Access

Clicking the Port Access button brings up a dialog box that allows the Administrator or a User with Administration permission to define the selected User's access to the computers on a port-by-port basis:

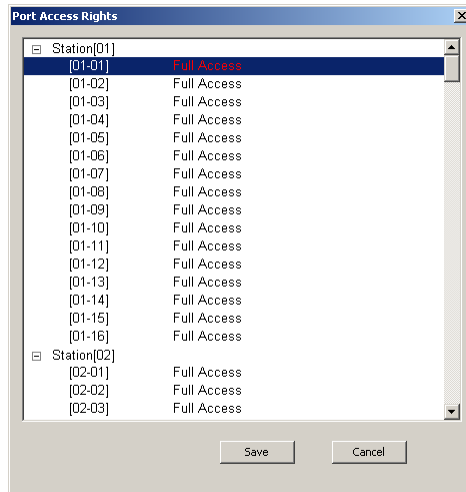

Note: If the list is collapsed, click the [+] in front of the Station to expand the list and show the ports

The access rights choices are explained in the table, below:

Choice	Explanation
Full	The user can view the remote server's screen and can perform keyboard and mouse operations on the remote server.
View Only	The user can only view the remote server's screen; he cannot perform any operations on it.
None	No access rights – the port will not show up on the user's List of ports on the Main Screen.

The default setting is *Full* for all users on all ports. The access rights can be changed in the following ways:

- ◆ Click directly over an access right to cycle through the choices
- ◆ Move the highlight bar to a port and press + to cycle forward through the choices
- ◆ Move the highlight bar to a port and press - to cycle backward through the choices
- ◆ [Shift] Click on any port to have all the ports on the Station cycle through the choices in unison
- ◆ Hold down [Shift] and tap + to have all the ports on the Station cycle forward through the choices in unison
- ◆ Hold down [Shift] and tap - to have all the ports on the Station cycle backward through the choices in unison
- ◆ When you have finished making your choices, click **Save**.
- ◆ If you want to abandon your choices and exit without saving, click **Cancel**.

Network

The Network dialog is used to specify the CS1708i / CS1716i's access ports and network environment.

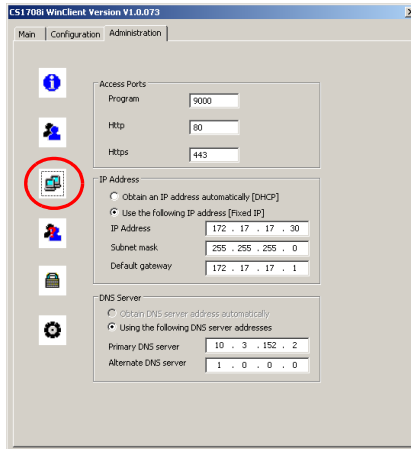

The information called for is the same as the information discussed under *Network* in the *Administration* chapter – see page 55 for details.

ANMS

The Advanced Network Management Settings page allows you to set up login authentication and authorization management from external sources.

The screenshot shows the 'Administration' tab of the 'CS1708i WinClient Version V1.0.073' interface. The 'Configuration' section is active, displaying various settings for external authentication and authorization services. A red circle highlights the 'Enable LDAP Authentication' section.

Section	Setting	Value
Enable RADIUS	Primary RADIUS Server IP	
	Port	1812
	Alternate RADIUS Server IP	
	Port	1812
	Timeout (seconds)	5
	Retries	3
Shared Secret (at least 6 characters)		
Enable CC management	CC Server IP	
	Port	0
	CC User Only (when CC server is connected)	<input type="checkbox"/>
Enable LDAP Authentication	LDAP	<input type="radio"/>
	LDAP5	<input checked="" type="radio"/>
	Enable Authorization	<input type="checkbox"/>
	LDAP Server IP	
	Port	636
	Timeout (seconds)	10
	LDAP Admin DN	
LDAP Admin Password		
Search DN		
Admin Group		
Log Server Settings	MAC Address	000000000000
	Port	9001

The information called for is the same as the information discussed under *ANMS* in the *Administration* chapter – see page 62 for details.

Security

The Network dialog is used to control access to the CS1708i / CS1716i.

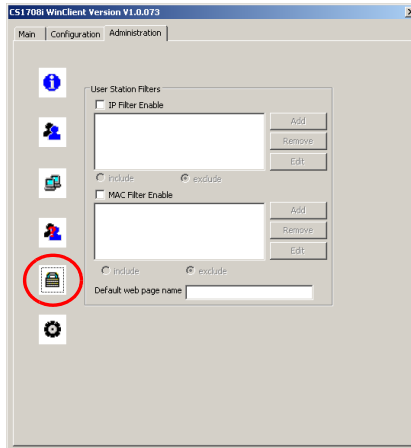

The information called for is the same as the information discussed under *Security* in the *Administration* chapter – see page 59 for details.

Customization

The Customization page allows the Administrator to set miscellaneous operational parameters for the CS1708i / CS1716i.

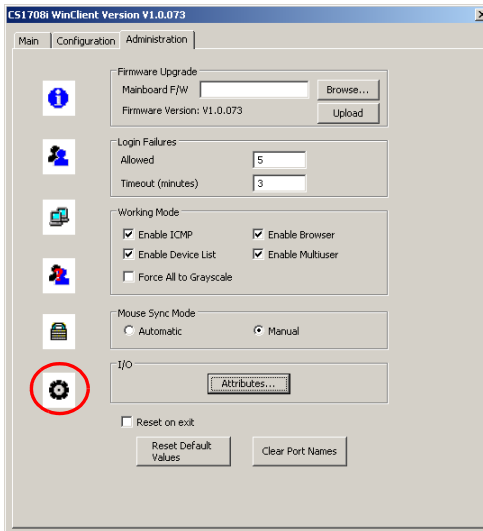

- ◆ The information called for in the *Firmware Upgrade* panel, is the same as the information discussed under *Maintenance* in the *Administration* chapter – see page 72 for details.
- ◆ The information called for in the *Login Failures*, *Working Mode*, and *Mouse Sync Mode* panels is the same as the information discussed under *Customization* in the *Administration* chapter – see page 69 for details.
- ◆ The meanings of the *Reset on exit*, *Restore Default Values*, and *Clear Port Names* parameters are the same as the ones discussed under *Reset* in the *Administration* chapter – see page 71 for details.

The I/O Panel

Clicking the *Attributes* button in the I/O panel brings up a dialog box that allows you to set attribute parameters for each of the ports:

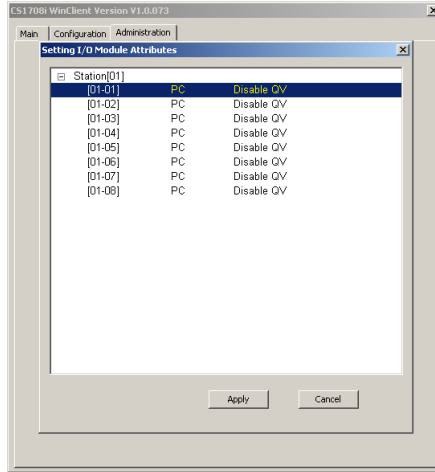

The port numbers are listed in the column on the left. The port's attributes are shown to its right.

- ◆ The first column to the right of the port numbers specifies the operating platform that the computer on the connected port is using. Choices are PC, Mac1, Sun, and Mac2. The default is PC.
- ◆ The next column sets the port's Quick View status (see *SET QUICK VIEW PORTS*, page 35). The default is Disable QV.
- ◆ To change an attribute:
 - ◆ Click on it to cycle through the choices.
 - ◆ Navigate to it with the Arrow Keys and press + or - to cycle through the choices. Hold down [Shift] while you press + or - to have all the ports on the Station cycle through the attribute choices in unison.

This Page Intentionally Left Blank

Chapter 8

The Java Client Viewer

Starting Up

The Java Client Viewer makes the CS1708i / CS1716i accessible to all platforms that have the Java Runtime Environment (JRE) installed. (See *Requirements*, page 5, for the required JRE version.) The JRE is available for free download from the Java web site (<http://java.com>).

To run the Java Client Viewer, after you log in (see *Logging In*, page 49), Click the *Open Java Applet* link:

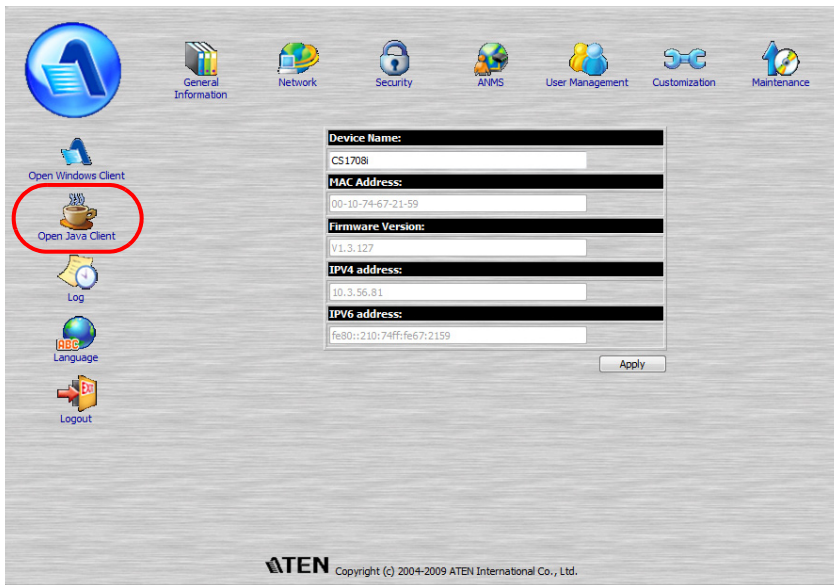

Note: The *Windows Client Viewer* icon is only available when you log in using the Microsoft Internet Explorer (IE) browser.

(Continues on next page.)

(Continued from previous page.)

A second or two after you click the *Open Java Applet* link, you connect to the switch:

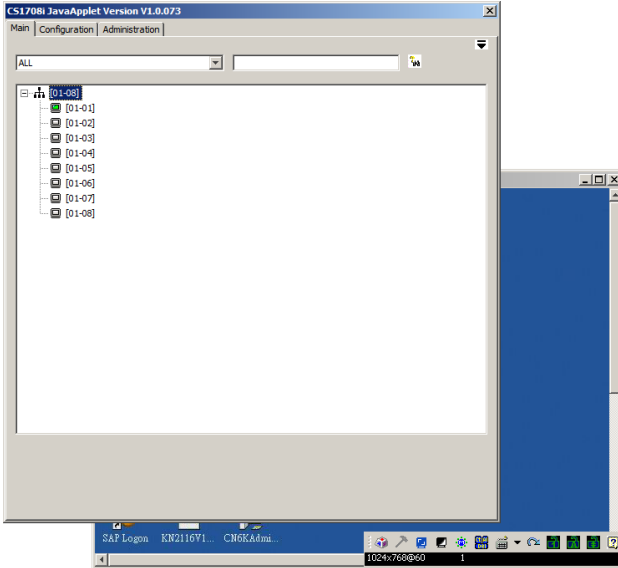

The CS1708i / CS1716i's GUI comes up with the *Main* page displayed in the center of the screen and a *Control Panel* displayed at the lower right. The GUI consists of three pages – *Main*, *Configuration*, and *Administration*. The *Main* page is what you use to switch ports and access the servers connected to them.

-
- Note:**
1. If another user is using the GUI, it does not appear. A message informing you that it is in use by another user appears, instead – you must wait until the other user finishes with it before it becomes available to you.
 2. The *Administration* tab is not available for users who don't have administration permission.
 3. The display of the server connected to the highlighted port in the GUI *Main* page may appear behind the GUI, but you can't work on it at this time. You can only work on it after accessing it with the GUI.
-

After switching to a port, you can work on the remote system via the screen display on your monitor just as if it were your local system.

- ◆ You can maximize the window, drag the borders to resize the window; or use the scrollbars to move around the screen.
- ◆ You can switch between your local and remote programs with [Alt + Tab].

Operation

The features and functions of Java Client Viewer operation are the same as those of the Windows Client Viewer. Refer to Chapter 7, *The Windows Client Viewer*, for details.

This Page Intentionally Left Blank

Chapter 9

The Log File

The Log File Screen

The CS1708i / CS1716i logs all the events that take place on it. Following a reset, it writes them to a log file, which is a searchable database. To view the contents of the log file, click the *Log* icon at the left of the page. A screen similar to the one below appears:

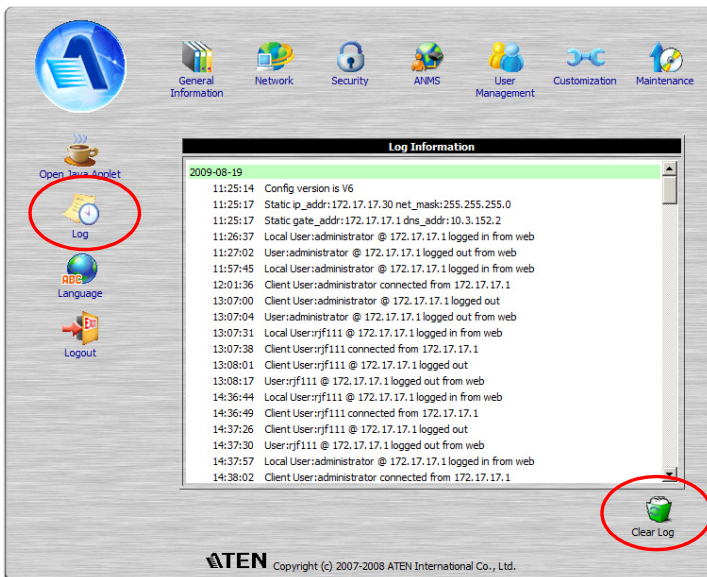

A maximum of 512 events are kept in the log file. As new events are recorded, they are placed at the bottom of the list. When a new event is recorded after there are 512 events in the log file, the earliest event in the list is discarded.

Note: To maintain and view a record of all the events that take place (not just the most recent 512), set up the Log Server AP program. See *The Log Server*, page 113.

To clear the log file, click on the *Clear Log* icon at the lower right of the page.

This Page Intentionally Left Blank

Chapter 10

The Log Server

The Log Server is a Windows-based administrative utility that records all the events that take place on selected CS1708i / CS1716i units and writes them to a searchable database. This chapter describes how to install and configure the Log Server.

Installation

1. With Windows running, put the CS1708i / CS1716i software CD that came with this product into the CD (DVD) drive.
2. Navigate to the *Log Server AP Installer* folder on the CD.
3. Click the *Log Server* icon to execute LogServerSetup.exe and start the installation.

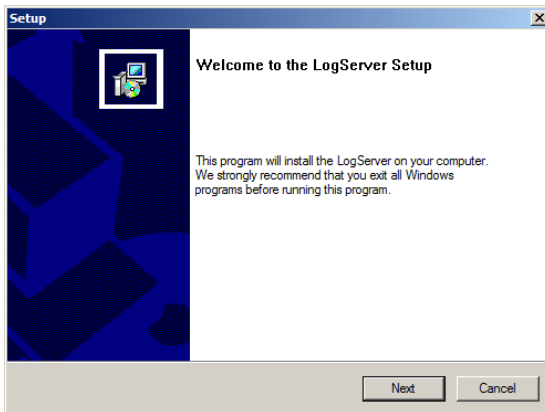

4. Click **Next**. Then follow the on-screen instructions to complete the installation and have the Log Server program icon placed on your desktop.

Starting Up

To bring up the Log Server, either double click the program icon, or key in the full path to the program on the command line. The first time you run it, a screen similar to the one below appears:

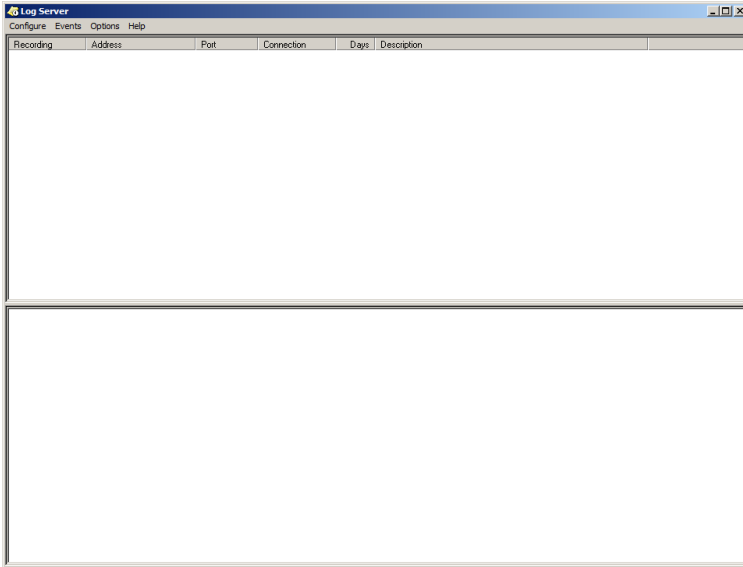

-
- Note:**
1. The MAC address of the Log Server computer must be specified in the *ANMS* settings – see *Log Server*, page 66 for details.
 2. The Log Server requires the Microsoft Jet OLEDB 4.0 driver. If the program doesn't start, see *The Log Server program does not run.*, page 142, .
-

The screen is divided into three components:

- ♦ A *Menu Bar* at the top
- ♦ A panel that will contain a list of CS1708i / CS1716i units in the middle (see *The Log Server Main Screen*, page 119, for details).
- ♦ A panel that will contain an *Events List* at the bottom

Each of the components is explained in the sections that follow.

The Menu Bar

The Menu bar consists of four items:

- ◆ Configure
- ◆ Events
- ◆ Options
- ◆ Help

These are discussed in the sections that follow.

Note: If the Menu Bar appears to be disabled, click in the CS1708i / CS1716i List window to enable it.

Configure

The Configure menu contains three items: Add, Edit, and Delete. They are used to add new CS1708i / CS1716i units to the CS1708i / CS1716i List, edit the information for units already on the list, or delete CS1708i / CS1716i units from the list.

- ◆ To add a CS1708i / CS1716i to the CS1708i / CS1716i List, click **Add**.
- ◆ To edit or delete a listed CS1708i / CS1716i, first select the one you want in the CS1708i / CS1716i List window, then open this menu and click **Edit** or **Delete**.

When you choose *Add* or *Edit*, a dialog box, similar to the one below appears:

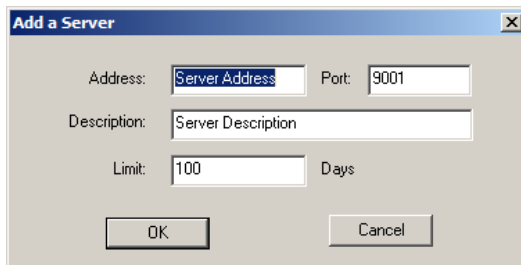

The screenshot shows a dialog box titled "Add a Server". It has a standard Windows-style title bar with a close button (X) on the right. The dialog contains the following fields and controls:

- Address:** A text input field containing "Server Address".
- Port:** A text input field containing "9001".
- Description:** A larger text input field containing "Server Description".
- Limit:** A text input field containing "100", followed by the label "Days".
- Buttons:** "OK" and "Cancel" buttons at the bottom.

A description of the fields is given in the table, below:

Field	Explanation
Address	This can either be the IP address of the CS1708i / CS1716i or its DNS name (if the network administrator has assigned it a DNS name). Key in the value specified for the CS1708i / CS1716i in the ANMS settings (see ANMS, page 62).
Port	Key in the port number that was specified for the CS1708i / CS1716i in the ANMS settings (see ANMS, page 62).
Description	This field is provided so that you can put in a descriptive reference for the unit to help identify it.
Limit	This specifies the number of days that an event should be kept in the Log Server's database before it expires and it is cleared out.

Fill in or modify the fields, then click **OK** to finish.

Events

The Events Menu has two items: *Search* and *Maintenance*.

Search

Search allows you to search for events containing specific words or strings.

When you access this function, a screen similar to the one below appears:

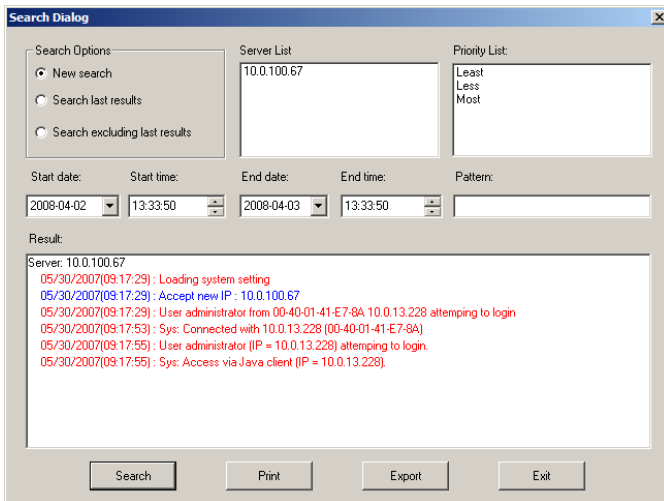

A description of the items is given in the table below:

Item	Explanation
New search	This is one of three radio buttons that define the scope of the search. If it is selected, the search is performed on all the events in the database for the selected CS1708i / CS1716i.
Search last results	This is a secondary search performed on the events that resulted from the last search.
Search excluding last results	This is a secondary search performed on all the events in the database for the selected CS1708i / CS1716i <i>excluding</i> the events that resulted from the last search.
Server List	CS1708i / CS1716i units are listed according to their IP address. Select the unit that you want to perform the search on from this list. You can select more than one unit for the search. If no units are selected, the search is performed on all of them.
Priority List	Sets the level for how detailed the search results display should be. 1 is the most general; 3 is the most specific.
Start Date	Select the date that you want the search to start from. The format follows the MM/DD/YYYY convention, as follows: 11/04/2005
Start Time	Select the time that you want the search to start from.
End Date	Select the date that you want the search to end at.
End Time	Select the time that you want the search to end at.
Pattern	Key in the pattern that you are searching for here. The multiple character wildcard (*) is supported. E.g., h*sds would match <i>hands</i> and <i>hoods</i> .
Results	Lists the events that contained matches for the search.
Search	Click this button to start the search.
Print	Click this button to print the search results.
Export	Click this button to write the search results to a .txt file.
Exit	Click this button to exit the Search dialog box.

Maintenance

This function allows the administrator to perform manual maintenance of the database, such as erasing specified records before the expiration time that was set with the *Limit* setting of the Edit function (see page 116).

Options

Network Retry allows you to set the number of seconds that the Log Server should wait before attempting to connect if the previous attempt to connect failed. When you click this item, a dialog box, similar to the one below appears:

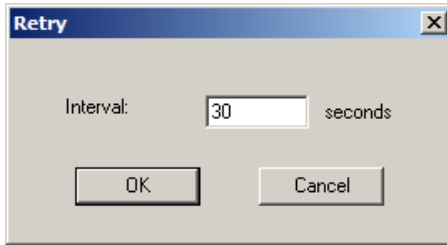

Key in the number of seconds, then click **OK** to finish.

Help

From the Help Menu, click Contents to access the online Windows Help file. The help file contains instructions about how to setup, operation and troubleshoot the Log Server.

The Log Server Main Screen

Overview

The Log Server Main Screen is divided into two main panels.

- ♦ The upper (List) panel lists the CS1708i / CS1716i units that have been selected for the Log Server to track (see *Configure*, page 115).
- ♦ The lower (Event) panel displays the log events for the currently selected CS1708i / CS1716i (the highlighted one - if there are more than one). To select a CS1708i / CS1716i unit in the list, simply click on it.

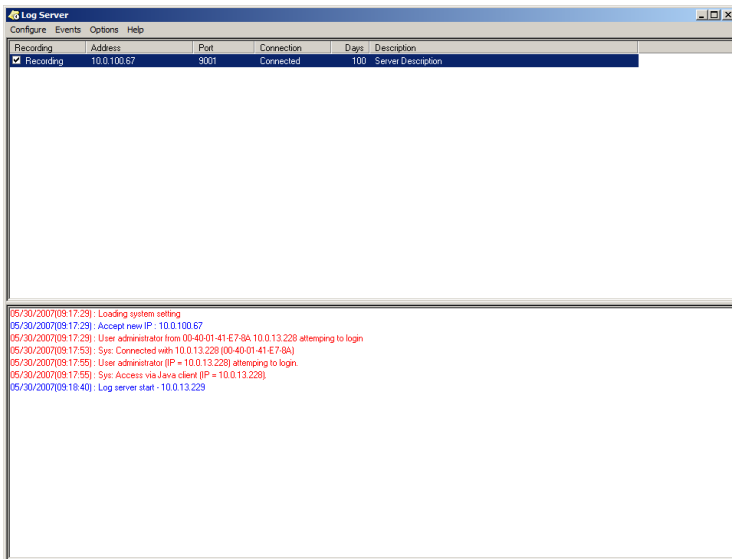

The List Panel

The List panel contains six fields:

Field	Explanation
Recording	Determines whether the Log Server records log events for this CS1708i / CS1716i or not. If the Recording check box is checked, the field displays <i>Recording</i> , and log events are recorded. If the Recording check box is not checked, the field displays <i>Paused</i> , and log events are not recorded. Note: Even though a CS1708i / CS1716i is not the currently selected one, if its Recording check box is checked, the Log Server will still record its log events.
Address	This is the IP Address or DNS name that was given to the CS1708i / CS1716i when it was added to the Log Server (see <i>Configure</i> , page 115).
Port	This is the port number that was assigned to the CS1708i / CS1716i when it was added to the Log Server (see <i>Configure</i> , page 115).
Connection	If the Log Server is connected to the CS1708i / CS1716i, this field displays <i>Connected</i> . If it is not connected, this field displays <i>Waiting</i> . This means that the Log Server's MAC address and/or port number has not been set properly. It needs to be set in the ANMS settings (see page 62) and specified in the <i>Configure</i> dialog box (see <i>Configure</i> , page 115).
Days	This field displays the number of days that the CS1708i / CS1716i's log events are to be kept in the Log Server's database before expiration (see <i>Configure</i> , page 115).
Description	This field displays the descriptive information given for the CS1708i / CS1716i when it was added to the Log Server (see <i>Configure</i> , page 115).

The Tick Panel

The lower panel displays tick information for the currently selected CS1708i / CS1716i. Note that if the installation contains more than one switch, even though a switch isn't currently selected, if its *Recording* checkbox is checked, the Log Server records its tick information and keeps it in its database.

Chapter 11

AP Operation

Overview

In some cases, the Administrator may not want the CS1708i / CS1716i to be available via browser access. AP versions of the Windows Client and the Java Client are provided to enable direct access of the CS1708i / CS1716i without having to go through a browser.

The programs are initially downloaded from the browser page. After they have been downloaded by the Users, the Administrator can disable browser access (see *Working Mode*, page 70).

The Windows Client

Installation

To install the Windows Client on your computer, do the following:

1. Run the program WinClient.exe on the software CD that came with your CS1708i / CS1716i package.
2. Follow along with the installation dialog boxes.
3. When the installation completes, an icon – *CS1708i iClient* or *CS1716i iClient* – is placed on your desktop and a program entry is made in the Windows *Start* menu:
(Start → All Programs → CS1716i → WinClient).

(Continues on next page.)

Starting Up

To connect to the CS1708i / CS1716i, either click its icon on the desktop or click its entry on the Start menu. If this is the first time that you are running the utility, a dialog box appears requesting you to input your serial number.

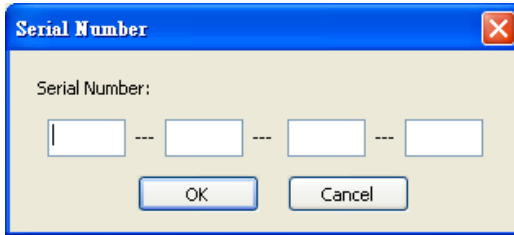

The serial number can be found on the CS1708i / CS1716i's CD case. Key in the serial number - 5 characters per box - then click **OK** to bring up the CS1708i / CS1716i Connection Screen.

-
- Note:**
1. Letters in the serial number must be entered in capitals.
 2. This dialog box only appears the first time you run the program. In the future, you go directly to the Windows Client Connection screen.
-

To connect to the CS1708i / CS1716i, click the *WinClient.exe* program icon (on your desktop) to bring up the Windows Client Connection Screen:

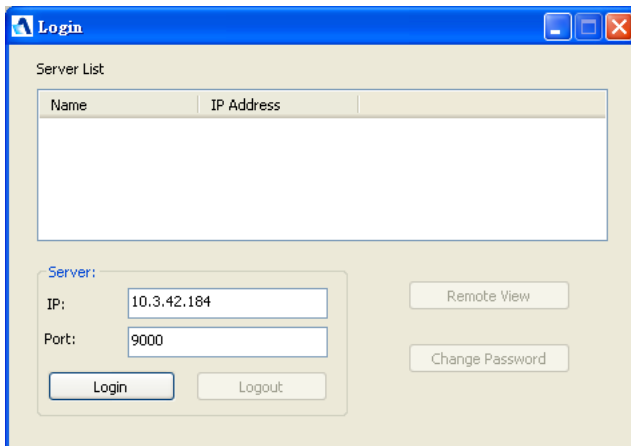

-
- Note:** You must have DirectX 8.0 or higher installed on your computer. If not, the Client program will not load.
-

A description of the Connection Screen is given in the following table:

Server List	Each time the WinClient.exe file is run, it searches the user's local LAN segment for CS1708i / CS1716i units, and lists whichever ones it finds in this box. If you want to connect to one of these units, double-click it.
Server	<p>This area is used when you want to connect to a CS1708i / CS1716i at a remote location. You can drop down the <i>IP</i> list box and select an address from the list. If the address you want isn't listed, you can key in the IP address you want. Then, key in the Port number in the <i>Port</i> field. If you don't know the Port number, contact your Administrator.</p> <ul style="list-style-type: none"> ◆ When the IP address and Port number for the unit you wish to connect to have been specified, click Login. ◆ When you have finished with your session and come back to this dialog box, click Logout.
Message List	Lists status messages regarding the connection to the CS1708i / CS1716i.
Switch to Remote View	<p>Once contact with a CS1708i / CS1716i has been established, this button becomes active. Click it to switch and take over console control of the unit that is attached to the CS1708i / CS1716i.</p> <p>The screen output of the unit appears on your monitor. Your keystrokes and mouse movements are captured and sent to the CS1708i / CS1716i to be executed on the attached unit.</p> <p>If the CS1708i / CS1716i is connected to a KVM switch, you can control the switch and the computers connected to it just as if you were connected locally.</p>
Change Password	This button becomes active after a connection to a CS1708i / CS1716i unit has been established. It allows the user to change the password used to log in to the CS1708i / CS1716i.

Connecting

To connect to a CS1708i / CS1716i unit:

1. From the *Server List* box, **double-click** the device that you wish to connect to.
– Or –
Specify the IP address and port number in the *Server IP* and *Port* input boxes, and then Click **Login**. The *Login* dialog box appears:

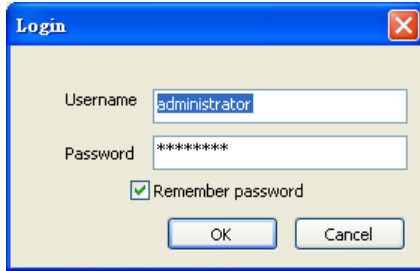

2. Key in a valid Username and Password, and then click **OK**.
3. Once contact with the CS1708i / CS1716i has been established, the *Switch to Remote View* button becomes active. Click it to connect to the CS1708i / CS1716i and take over console control of the unit that is connected to it.

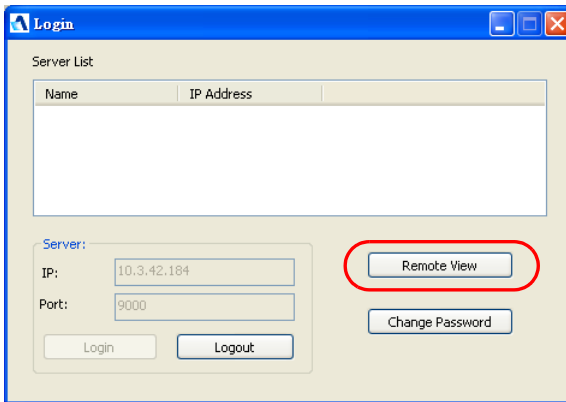

Operation

Once a connection to the CS1708i / CS1716i has been established, the remote system's video output is captured and displayed on your monitor. At the same time, your local keystroke and mouse input is captured and sent to the remote system.

The look and feel of the AP Windows client operation is the same as for the *The Windows Client Viewer*. Refer back to Chapter 7, for details.

Ending the Session

After you log out of the CS1708i / CS1716i, you return to the Connection dialog box. Click **Logout** to end the session.

The Java Client

Starting Up

To connect to the CS1708i / CS1716i with the Java Client AP program, do the following:

1. Copy *iClient.jar* from the software CD that came with your CS1708i / CS1716i package to a convenient location on your computer.
2. Double click the *iClient.jar* icon – or key in the full path to the program on the command line – to bring up the Java Client Connection screen.

If this is the first time that you are running the program a dialog box appears requesting you to input your serial number.

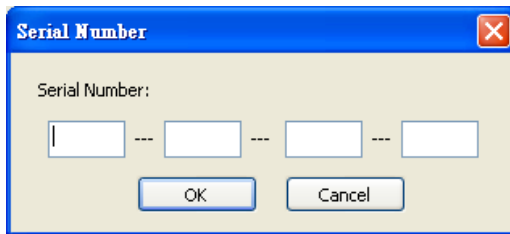

The serial number can be found on the CS1708i / CS1716i's CD case. Key in the serial number - 5 characters per box - then click **OK** to bring up the CS1708i / CS1716i Connection Screen.

-
- Note:**
1. Letters in the serial number must be entered in capitals.
 2. This dialog box only appears the first time you run the program. In the future, you go directly to the Connect dialog box.
-

The *Connect* dialog box appears:

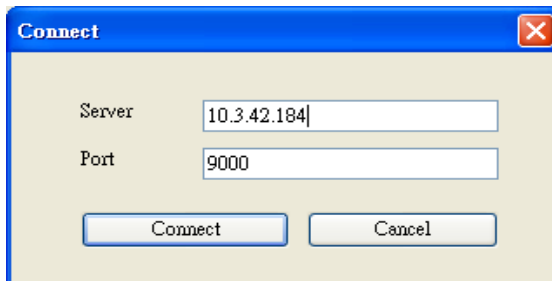

3. Key in the IP address and port number of the target switch, then click **Connect**.

After you establish a connection, a *Login* dialog box appears:

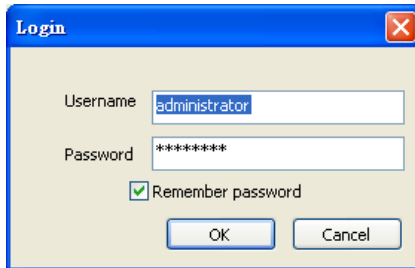

4. Provide a valid Username and Password, and then click **OK**.

Once the authentication procedure completes successfully, the CS1708i / CS1716i main page displays on your monitor.

Operation

The look and feel of the Java Client AP operation is the same as for the Java Client Viewer. Refer back to Chapter 8 for details.

This Page Intentionally Left Blank

Chapter 12

The Firmware Upgrade Utility

Introduction

The purpose of the Windows-based Firmware Upgrade Utility is to provide an automated process for upgrading all CS1708i / CS1716i switches in an installation. The program comes as part of a Firmware Upgrade Package that is specific for each device.

As new firmware versions become available, new firmware upgrade packages are posted on our website. Check the website regularly to find the latest information and packages.

-
- Note:**
1. The firmware upgrade described in this chapter refers to the CS1708i / CS1716i's mainboard firmware.
 2. Each time you perform this upgrade, you must also do a browser-based upgrade to upgrade the icard firmware (see *Maintenance*, page 72 for details).
-

Downloading the Firmware Upgrade Package

To download the firmware upgrade package:

1. From a computer that is not part of your KVM installation go to our Website and choose the model name that relates to your device. A list of available firmware upgrade packages appears.
2. Choose the firmware upgrade package that you wish to install (usually the most recent) and download it to your computer.

Preparation

To prepare for the firmware upgrade, do the following:

1. Use the *Firmware Upgrade Cable* provided with this unit to connect a COM port on your computer to the *Firmware Upgrade Port* of your switch.

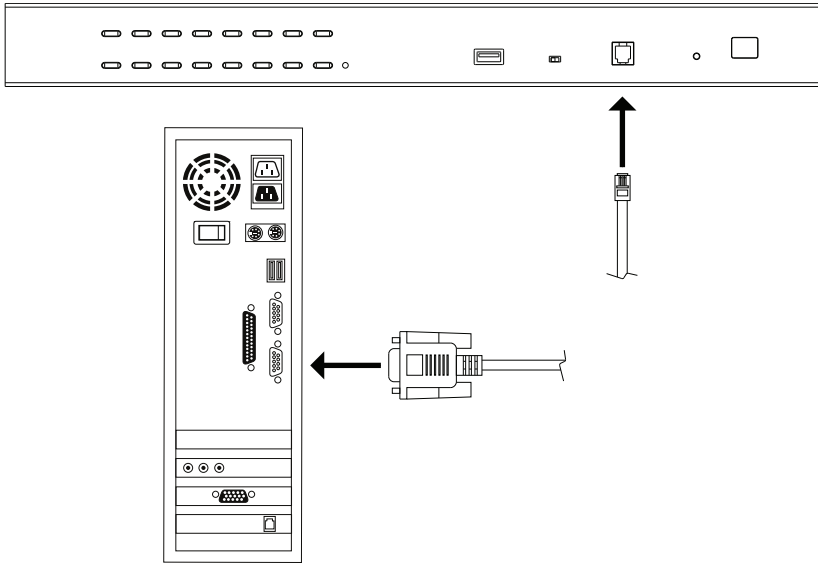

2. Shut down all the computers, but not the stations, on the KVM installation.
3. From your KVM switch console, login to the OSD as the administrator (see page 27) and select the **F4 ADM** function.
4. Scroll down to FIRMWARE UPGRADE. Press **[Enter]**, then press **[Y]** to invoke *Firmware Upgrade* mode (see page 36.)

Starting the Upgrade

To upgrade the firmware:

1. Run the downloaded firmware upgrade package file either by double-clicking the file icon, or by opening a command line and entering the full path to it.

The *Firmware Upgrade Utility* welcome screen appears:

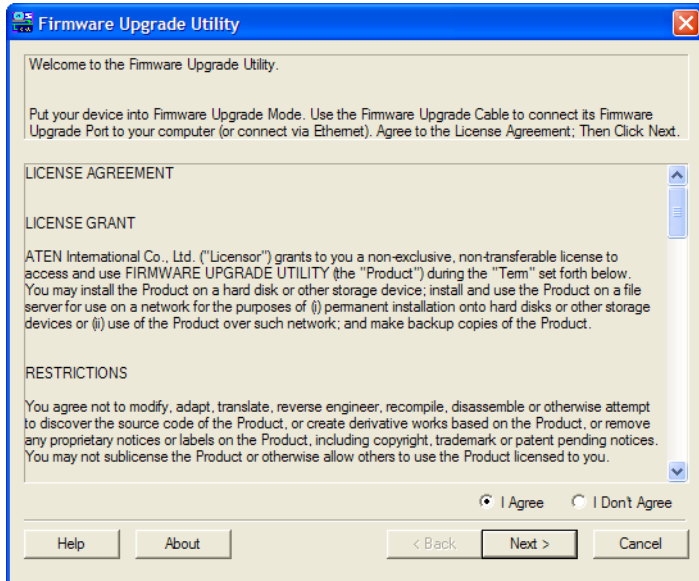

Note: The screens shown in this section are for reference only. The wording and layout of the actual screens put up by the *Firmware Upgrade Utility* may vary slightly from these examples.

2. Read and *Agree* to the License Agreement (enable the *I Agree* radio button).

3. Click **Next** to continue. The *Firmware Upgrade Utility* main screen appears. The devices capable of being upgraded are listed in the *Device List* panel:

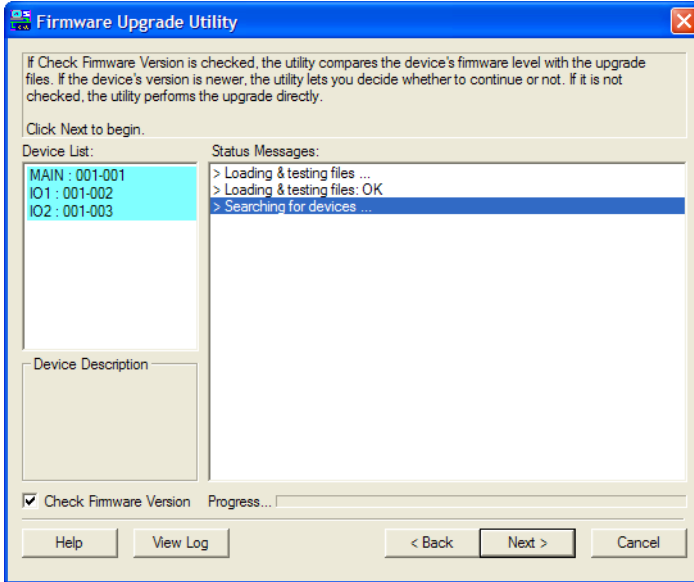

4. Click **Next** to perform the upgrade.

If you enabled *Check Firmware Version*, the Utility compares the device's firmware level with that of the upgrade files. If it finds that the device's version is higher than the upgrade version, it brings up a dialog box informing you of the situation and gives you the option to continue or cancel.

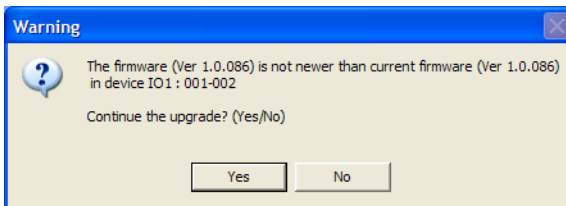

If you didn't enable *Check Firmware Version*, the Utility installs the upgrade files without checking whether they are a higher level, or not.

As the upgrade proceeds, status messages appear in the *Status Messages* panel, and the progress toward completion is shown on the *Progress* bar.

Upgrade Succeeded

After the upgrade has completed, a screen appears to inform you that the procedure was successful:

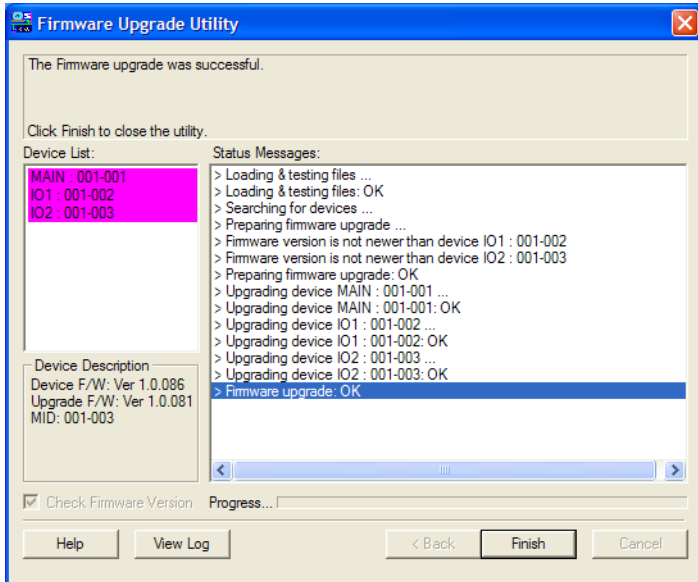

Click **Finish** to close the *Firmware Upgrade Utility*.

Upgrade Failed

If the *Upgrade Succeeded* screen doesn't appear, it means that the upgrade failed to complete successfully. See the next section, *Firmware Upgrade Recovery*, for how to proceed.

Firmware Upgrade Recovery

There are three conditions that call for firmware upgrade recovery:

- ◆ When a firmware upgrade is manually aborted.
- ◆ When the mainboard firmware upgrade fails.
- ◆ When the I/O firmware upgrade fails.

To perform a firmware upgrade recovery, do the following:

1. Power off the switch. If it is part of a daisy chain, disconnect it from the chain.
2. Connect the *Firmware Upgrade Cable* to its *Firmware Upgrade Port*.
3. Slide the *Firmware Upgrade Recovery Switch* to the **Recover** position.
4. Power the switch back on and repeat the upgrade procedure.
5. After the switch has been successfully upgraded, power it off, and slide the *Firmware Upgrade Recovery Switch* back to the **Normal** position.
6. If the switch is part of a daisy chain, replace it in the chain.
7. Power the switch back on.

Safety Instructions

General

- ◆ This product is for indoor use only.
- ◆ Read all of these instructions. Save them for future reference.
- ◆ Follow all warnings and instructions marked on the device.
- ◆ Do not place the device on any unstable surface (cart, stand, table, etc.). If the device falls, serious damage will result.
- ◆ Do not use the device near water.
- ◆ Do not place the device near, or over, radiators or heat registers.
- ◆ The device cabinet is provided with slots and openings to allow for adequate ventilation. To ensure reliable operation, and to protect against overheating, these openings must never be blocked or covered.
- ◆ The device should never be placed on a soft surface (bed, sofa, rug, etc.) as this will block its ventilation openings. Likewise, the device should not be placed in a built in enclosure unless adequate ventilation has been provided.
- ◆ Never spill liquid of any kind on the device.
- ◆ Unplug the device from the wall outlet before cleaning. Do not use liquid or aerosol cleaners. Use a damp cloth for cleaning.
- ◆ The device should be operated from the type of power source indicated on the marking label. If you are not sure of the type of power available, consult your dealer or local power company.
- ◆ The device is designed for IT power distribution systems with 230V phase-to-phase voltage.
- ◆ To prevent damage to your installation it is important that all devices are properly grounded.
- ◆ The device is equipped with a 3-wire grounding type plug. This is a safety feature. If you are unable to insert the plug into the outlet, contact your electrician to replace your obsolete outlet. Do not attempt to defeat the purpose of the grounding-type plug. Always follow your local/national wiring codes.
- ◆ Do not allow anything to rest on the power cord or cables. Route the power cord and cables so that they cannot be stepped on or tripped over.

- ◆ If an extension cord is used with this device make sure that the total of the ampere ratings of all products used on this cord does not exceed the extension cord ampere rating. Make sure that the total of all products plugged into the wall outlet does not exceed 15 amperes.
- ◆ To help protect your system from sudden, transient increases and decreases in electrical power, use a surge suppressor, line conditioner, or un-interruptible power supply (UPS).
- ◆ Position system cables and power cables carefully; Be sure that nothing rests on any cables.
- ◆ Never push objects of any kind into or through cabinet slots. They may touch dangerous voltage points or short out parts resulting in a risk of fire or electrical shock.
- ◆ Do not attempt to service the device yourself. Refer all servicing to qualified service personnel.
- ◆ If the following conditions occur, unplug the device from the wall outlet and bring it to qualified service personnel for repair.
 - ◆ The power cord or plug has become damaged or frayed.
 - ◆ Liquid has been spilled into the device.
 - ◆ The device has been exposed to rain or water.
 - ◆ The device has been dropped, or the cabinet has been damaged.
 - ◆ The device exhibits a distinct change in performance, indicating a need for service.
 - ◆ The device does not operate normally when the operating instructions are followed.
- ◆ Only adjust those controls that are covered in the operating instructions. Improper adjustment of other controls may result in damage that will require extensive work by a qualified technician to repair.
- ◆ Do not connect the RJ-11 connector marked “UPGRADE” to a public telecommunication network.

Rack Mounting

- ◆ Before working on the rack, make sure that the stabilizers are secured to the rack, extended to the floor, and that the full weight of the rack rests on the floor. Install front and side stabilizers on a single rack or front stabilizers for joined multiple racks before working on the rack.
- ◆ Always load the rack from the bottom up, and load the heaviest item in the rack first.
- ◆ Make sure that the rack is level and stable before extending a device from the rack.
- ◆ Do not overload the AC supply branch circuit that provides power to the rack. The total rack load should not exceed 80 percent of the branch circuit rating.
- ◆ Make sure that all equipment used on the rack – including power strips and other electrical connectors – is properly grounded.
- ◆ Ensure that proper airflow is provided to devices in the rack.
- ◆ Ensure that the operating ambient temperature of the rack environment does not exceed the maximum ambient temperature specified for the equipment by the manufacturer
- ◆ Do not step on or stand on any device when servicing other devices in a rack.

Technical Support

International

- ◆ For online technical support – including troubleshooting, documentation, and software updates: **<http://support.aten.com>**
- ◆ For telephone support, see *Telephone Support*, page iii.

North America

Email Support		support@aten-usa.com
Online Technical Support	Troubleshooting Documentation Software Updates	http://www.aten-usa.com/support
Telephone Support		1-888-999-ATEN ext 4988

When you contact us, please have the following information ready beforehand:

- ◆ Product model number, serial number, and date of purchase.
- ◆ Your computer configuration, including operating system, revision level, expansion cards, and software.
- ◆ Any error messages displayed at the time the error occurred.
- ◆ The sequence of operations that led up to the error.
- ◆ Any other information you feel may be of help.

Troubleshooting

The first step in solving problems is to make sure that all cables are securely attached and seated completely in their sockets. In addition, if your product is not running the latest firmware version, we strongly recommend that you upgrade.

Administration

Problem	Resolution
After upgrading firmware, the CS1708i / CS1716i still appears to be using the old firmware version.	Your Internet browser is displaying cached web pages – not new ones. Clear your browser cache; delete all temporary Internet files and cookies, close the Internet browser, and then open a new instance of the browser.
The default network setting for the CS1708i / CS1716i is DHCP, but the network uses fixed IP addresses and doesn't have a DHCP server.	Use the local console OSD's F4 function to give the CS1708i / CS1716i a fixed IP address. See <i>SET IP ADDRESS</i> , page 34, for details.

General Operation

Problem	Resolution
Erratic Operation	Check that the power adapter that was supplied with the unit is plugged in and functioning properly. Press and hold the Reset Switch (see page 9) for longer than three seconds.
Mouse and/or keyboard not responding due to improper mouse and/or keyboard reset.	Unplug the cable(s) from the console port(s), then plug it/them back in again.
All Station IDs display as 01.	Station 1 has suddenly lost power. Wait a few seconds for the system to reinitialize the station sequence and display the proper IDs.
Sudden loss of network connection due to local reset of CS1708i / CS1716i.	Close your CS1708i / CS1716i connection. Wait approximately 30 seconds, and log in again.
Mouse Pointer does not move	If Mouse DynaSync™ is enabled (see <i>Automatic</i> , page 70), all computers connected to the switch must use USB Adapter Cables. Otherwise, the mouse pointer will not move.
Mouse Pointer Confusion	If you find the display of two mouse pointers (local and remote) to be confusing or annoying, you can use the <i>Toggle Pointer Display</i> function to hide the non-functioning pointer. See page 79 for details.

The Windows Client

Problem	Resolution
Windows Client won't connect to the CS1708i / CS1716i.	DirectX 8.0 or higher must be installed on your computer.
Remote mouse pointer is out of sync.	<ol style="list-style-type: none"> 1. Use the <i>AutoSync</i> feature (see <i>Video Settings</i>, page 81), to sync the local and remote monitors. 2. If that doesn't resolve the problem, use the <i>Adjust Mouse</i> feature (see <i>Adjust mouse</i>, page 79) to bring them back in sync. 3. If the two methods described above fail to resolve the problem, use the <i>Toggle Pointer Display</i> function (see page 79).
Part of remote window is off my monitor.	Use the <i>AutoSync</i> feature (see <i>Video Settings</i> , page 81) to synchronize the local and remote monitors.
My antivirus program reports that there is a trojan after I access the CS1708i / CS1716i with my browser and then open the Windows Client Viewer.	The Windows Client Viewer uses an ActiveX plugin (windows.ocx) that some antivirus programs mistakenly see as a virus or trojan. We have tested our firmware extensively and found no evidence of a virus or trojan. You can add the plugin to your antivirus program's White List and use the Viewer safely. If you are reluctant to use the Windows Client Viewer, however, you can simply use the Java Client Viewer, instead.

The Java Client

For mouse synchronization problems, see *Mouse Sync Mode*, page 70. For connection and operation problems, see the table below:

Problem	Resolution
Java Client won't connect to the CS1708i / CS1716i.	<ol style="list-style-type: none"> 1. Java JRE 6 or higher must be installed on your computer. 2. Make sure to include the correct login string when you specify the CS1708i / CS1716i's IP address (see <i>Login String</i>, page 61). 3. Close the Java Client, reopen it, and try again.
Pressing the Windows Menu key has no effect.	Java doesn't support the Windows Menu key.
Java Client performance deteriorates.	Exit the program and start again.
National language characters do not appear.	When entering national language characters, if your local keyboard is set to a non-English national language layout, you must set the remote computer's keyboard layout to English.

Sun Systems

Problem	Resolution
Video display problems with HDB-15 interface systems (e.g. Sun Blade 1000 servers).	<p>The display resolution should be set to 1024 x 768.</p> <p>Under Text Mode:</p> <ol style="list-style-type: none"> Go to OK mode and issue the following commands: <pre>setenv output-device screen:r1024x768x60 reset-all</pre> <p>Under XWindow:</p> <ol style="list-style-type: none"> Open a console and issue the following command: <pre>m64config -res 1024x768x60</pre> Log out. Log in.
Video display problems with 13W3 interface systems (e.g. Sun Ultra servers).*	<p>The display resolution should be set to 1024 x 768.</p> <p>Under Text Mode:</p> <ol style="list-style-type: none"> Go to OK mode and issue the following commands: <pre>setenv output-device screen:r1024x768x60 reset-all</pre> <p>Under XWindow:</p> <ol style="list-style-type: none"> Open a console and issue the following command: <pre>ffbconfig -res 1024x768x60</pre> Log out. Log in.

* These solutions work for most common Sun VGA cards. If using them fails to resolve the problem, consult the Sun VGA card's manual.

The Log Server

Problem	Resolution
The Log Server program does not run.	<p>The Log Server requires the Microsoft Jet OLEDB 4.0 driver in order to access the database.</p> <p>This driver is automatically installed with Windows ME, 2000, and XP.</p> <p>For Windows 98 and NT you will have to go to the Microsoft download site:</p> <p style="padding-left: 40px;">http://www.microsoft.com/data/download.htm</p> <p>to retrieve the driver file:</p> <p style="padding-left: 40px;"><i>MDAC 2.7 RTM Refresh (2.70.9001.0)</i></p> <p>Since this driver is used in Windows Office Suite, an alternate method of obtaining it is to install Windows Office Suite. Once the driver file or Suite has been installed, the Log Server will run.</p>









Panel Array Mode

Problem	Resolution
Low resolution video in Panel Array Mode.	Increase the number of panels that are displayed.
Some users only receive a partial image when multiple remote users are logged in concurrently.	The first user to invoke Panel Array Mode should set it to display a minimum of four panels.

Keyboard Emulation

Mac Keyboard







The PC compatible (101/104 key) keyboard can emulate the functions of the Mac keyboard. The emulation mappings are listed in the table below.

PC Keyboard	Mac Keyboard
[Shift]	Shift
[Ctrl]	Ctrl
	
[Ctrl] [1]	
[Ctrl] [2]	
[Ctrl] [3]	
[Ctrl] [4]	
[Alt]	Alt
[Print Screen]	F13
[Scroll Lock]	F14
	=
[Enter]	Return
[Backspace]	Delete
[Insert]	Help
[Ctrl] 	F15

Note: When using key combinations, press and release the first key (Ctrl), then press and release the activation key.

Sun Keyboard

The PC compatible (101/104 key) keyboard can emulate the functions of the Sun keyboard when the control key [Ctrl] is used in conjunction with other keys. The corresponding functions are shown in the table below.

PC Keyboard	Sun Keyboard
[Ctrl] [T]	Stop
[Ctrl] [F2]	Again
[Ctrl] [F3]	Props
[Ctrl] [F4]	Undo
[Ctrl] [F5]	Front
[Ctrl] [F6]	Copy
[Ctrl] [F7]	Open
[Ctrl] [F8]	Paste
[Ctrl] [F9]	Find
[Ctrl] [F10]	Cut
[Ctrl] [1]	
[Ctrl] [2]	
[Ctrl] [3]	
[Ctrl] [4]	
[Ctrl] [H]	Help
	Compose
	

Note: When using key combinations, press and release the first key (Ctrl), then press and release the activation key.

IP Address Determination

If you are an administrator logging in over the Net for the first time, you need to access the CS1708i / CS1716i in order to give it an IP address that users can connect to. There are three methods to choose from. In each case, your computer must be on the same network segment as the CS1708i / CS1716i. After you have connected and logged in you can give the CS1708i / CS1716i its fixed network address. (See *Network*, page 55.)

IP Installer

For computers running Windows, an IP address can be assigned with the IP Installer utility:

1. Unzip the contents of *IPInstaller.zip* (found on the Software CD that came with your CS1708i / CS1716i package) to a directory on your hard drive.
2. Go to the directory that you unzipped the IPInstaller program to and run *IPInstaller.exe*. A dialog box similar to the one below appears:

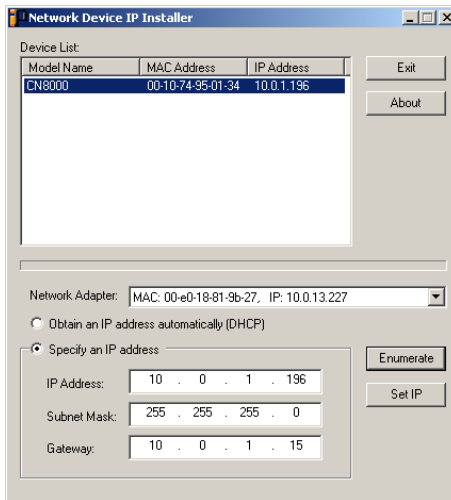

3. Select the CS1708i / CS1716i in the *Device List*.

Note: 1. If the list is empty, or your device doesn't appear, click **Enumerate** to refresh the *Device List*.

2. If there is more than one device in the list, use the MAC address to pick the one you want. The CS1708i / CS1716i's MAC address is located on its bottom panel.
-

4. Select either *Obtain an IP address automatically (DHCP)*, or *Specify an IP address*. If you chose the latter, fill the IP Address, Subnet Mask, and Gateway fields with the information appropriate to your network.
5. Click **Set IP**.
6. After the IP address shows up in the Device List, click **Exit**.

Browser

1. Set your computer's IP address to 192.168.0.XXX
Where XXX represents any number or numbers except 60. (192.168.0.60 is the default address of the CS1708i / CS1716i.)
2. Specify the switch's default IP address (192.168.0.60) in your browser, and you will be able to connect.
3. Assign a fixed IP address for the CS1708i / CS1716i that is suitable for the network segment that it resides on.
4. After you log out, reset your computer's IP address to its original value.

AP Windows Client

For computers running Windows, the CS1708i / CS1716i's IP address can be determined with the Windows AP program (see *The Windows Client*, page 121). When you run the program it searches the network segment for CS1708i / CS1716i devices, and displays the results in a dialog box similar to the one below:

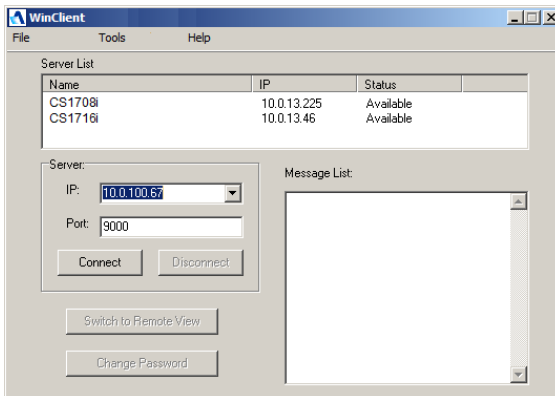

You can now use this network address, or you can change it by clicking **Login**, logging in, clicking **Admin Utility**, and clicking the *Network* tab.

IPv6

At present, the CS1708i / CS1716i supports three IPv6 address protocols: *Link Local IPv6 Address*, *IPv6 Stateless Autoconfiguration*, and *Stateful Autoconfiguration (DHCPv6)*.

Link Local IPv6 Address

At power on, the CS1708i / CS1716i is automatically configured with a Link Local IPv6 Address (for example, fe80::210:74ff:fe61:1ef). To find out what the Link Local IPv6 Address is, log in with the CS1708i / CS1716i's IPv4 address and the address is displayed on the *General Information page*.

Once you have determined what the IPv6 address is, you can use it when logging in from a browser or the Win and Java Client AP programs.

For example:

If you are logging in from a browser, you would key in

```
http://[fe80::2001:74ff:fe6e:59%5]
```

for the URL bar.

If you are logging in with the AP program, you would key:

```
fe80::2001:74ff:fe6e:59%5
```

-
- Note:** 1. To log in with the Link Local IPv6 Address, the client computer must be on the same local network segment as the CS1708i / CS1716i.
2. The %5 is the %interface used by the client computer. To see your client computer's IPv6 address: from the command line issue the following command: `ipconfig /all`. The % value appears at the end of the IPv6 address.
-

IPv6 Stateless Autoconfiguration

If the CS1708i / CS1716i's network environment contains a device (such as a router) that supports the IPv6 Stateless Autoconfiguration function, the CS1708i / CS1716i can obtain its prefix information from that device in order to generate its IPv6 address. For example, 2001::74ff:fe6e:59.

As above, the address is displayed on the *General Information page*.

Once you have determined what the IPv6 address is, you can use it when logging in from a browser or the Win and Java Client AP programs.

For example:

If you are logging in from a browser, you would key in

```
http://[2001::74ff:fe6e:59]
```

for the URL bar.

If you are logging in with the AP program, you would key:

```
2001::74ff:fe6e:59
```

Additional Mouse Synchronization Procedures

If the mouse synchronization procedures mentioned in the manual fail to resolve mouse pointer problems for particular computers, try the following:

- Note:** 1. These procedures are to be performed on the computers attached to the CS1708i / CS1716i's ports - not on the computer you are using to access the CS1708i / CS1716i.
2. In order for the local and remote mice to synchronize, you must use the generic mouse driver supplied with the Windows operating system. If you have a third party driver installed - such as one supplied by the mouse manufacturer - you must remove it.
-

1. Windows 2000:

Set the mouse speed to the middle position; set the mouse acceleration to *None* (Control Panel → Mouse → Mouse Properties → Motion):

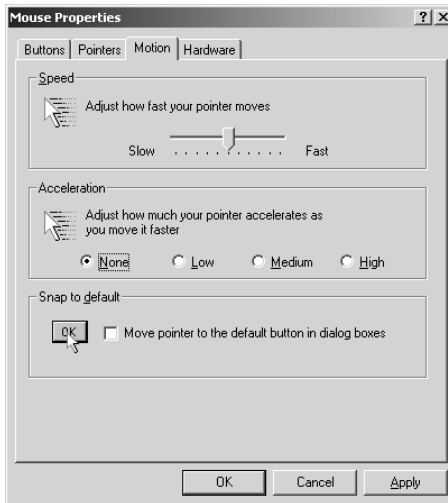

2. Windows XP / Windows Server 2003:

Set the mouse speed to the middle position; disable *Enhance Pointer Precision* (Control Panel → Printers and Other Hardware → Mouse → Pointer Options):

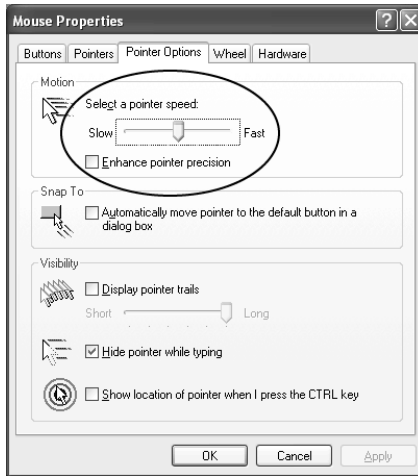

3. Windows ME / Windows 95:
Set the mouse speed to the middle position; disable mouse acceleration (click Advanced to get the dialog box for this).
4. Windows NT / Windows 98:
Set the mouse speed to the slowest position.
5. Sun / Linux:
Open a terminal session and issue the following command:
Sun: `xset m 1`
Linux: `xset m 0`

Trusted Certificates

Overview

When you try to log in to the device from your browser, a Security Alert message appears to inform you that the device's certificate is not trusted, and asks if you want to proceed.



The certificate can be trusted, but the alert is triggered because the certificate's name is not found on Microsoft list of Trusted Authorities. You have two options: 1) you can ignore the warning and click **Yes** to go on; or 2) you can install the certificate and have it be recognized as trusted.

- ◆ If you are working on a computer at another location, accept the certificate for just this session by clicking **Yes**.
- ◆ If you are working at your own computer, install the certificate on your computer (see below for details). After the certificate is installed, it will be recognized as trusted.

Installing the Certificate

To install the certificate, do the following:

1. In the *Security Alert* dialog box, click **View Certificate**. The *Certificate Information* dialog box appears:

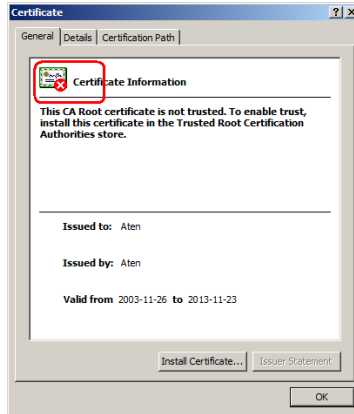

Note: There is a red and white X logo over the certificate to indicate that it is not trusted.

2. Click **Install Certificate**.
3. Follow the Installation Wizard to complete the installation. Unless you have a specific reason to choose otherwise, accept the default options.
4. When the Wizard presents a caution screen:

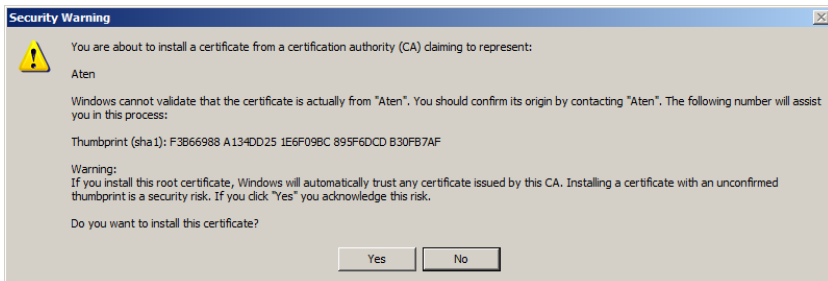

Click **Yes**.

- Next, click **Finish** to complete the installation; then click **OK** to close the dialog box.

Certificate Trusted

The certificate is now trusted:

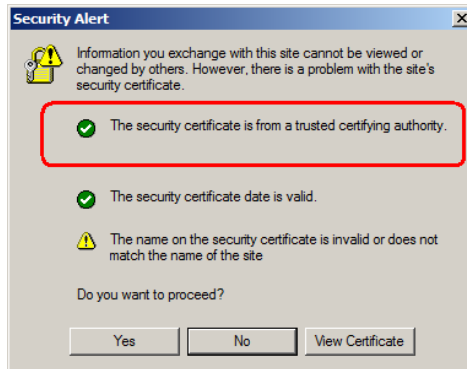

When you click *View Certificate*, you can see that the red and white X logo is no longer present – further indication that the certificate is trusted:

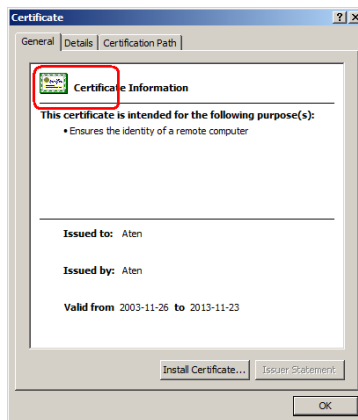

Specifications

Function		CS1708i	CS1716i
Computer Connections	Direct	8	16
	Max	128 (via daisy chain)	256 (via daisy chain)
Port Selection		OSD/GUI; Hotkey; Pushbutton	
Connectors	Console Port	1 x SPHD-18 M	
	KVM Ports	8 x SPHD-17 F	16 x SPHD-17 F
	Daisy Chain	1 x DB-25 M	
	Power	1 x DC Jack	
	LAN	1 x RJ45 F	
	FW Upgrade	1 x RJ-11	
	USB Port (1.1)	1 x USB Type A	
Switches	Reset	1 x Semi-recessed pushbutton	
	Port Selection	8 x Pushbutton	16 x Pushbutton
	FW Upgr. Rec.	1 x Slide	
LEDs	On Line	8 (Orange)	16 (Orange)
	Selected	8 (Green)	16 (Green)
	Station ID	1 x 2-digit, 7-segment (Orange)	
	Power	1 (Dark Green)	
	10/100 Mbps	1 (Orange/Green – at LAN port)	
Emulation	Keyboard/Mouse	PS/2, USB	
Video	Local Console	2048 x 1536; DDC2B	
	Remote	1600 x 1200 @60Hz / 24bit color depth	
Scan Interval (OSD Select)		1–255 sec.	
Power Consumption		DC 5.3 V; 9.5 W	DC 5.3 V; 11 W
Environment	Operating Temp.	0–50° C	
	Storage Temp.	-20–60° C	
	Humidity	0–80% RH, Non-condensing	
Physical Properties	Housing	Metal	
	Weight	2.81 kg	3.00 kg
	L x W x H	43.30 x 16.00 x 4.40 cm	

Connection Tables

The following tables indicate the relationship between the number of switches and the number of computers that they control.

CS1708i

No.	Computers	No.	Computers
1	1 - 8	9	65 - 72
2	9 - 16	10	73 - 80
3	17 - 24	11	81 - 88
4	25 - 32	12	89 - 96
5	33 - 40	13	97 - 104
6	41 - 48	14	105 - 112
7	49 - 56	15	113 - 120
8	57 - 64	16	121 - 128

CS1716i

No.	Computers	No.	Computers
1	1 - 16	9	129 - 144
2	17 - 32	10	145 - 160
3	33 - 48	11	161 - 176
4	49 - 64	12	177 - 192
5	65 - 80	13	193 - 208
6	81 - 96	14	209 - 224
7	97 - 112	15	225 - 240
8	113 - 128	16	241 - 256

Supported KVM Switches

The table below lists KVM switches that are compatible with the CS1708i / CS1716i and the type of expansion that they use. (KVM switches listed below are sold separately. Contact your dealer for details.)

Expansion Type	Brand	Model	Name
Daisy Chain	ATEN	ACS1208A	8 Port PS/2 KVM Switch
		ACS1216A	16 Port PS/2 KVM Switch
		CL1208	8 Port USB / PS/2 LCD KVM Switch
		CL1216	16 Port USB / PS/2 LCD KVM Switch
		CS1708	8 Port USB KVM Switch
		CS1716	16 Port USB KVM Switch
		CS1708A	8 Port USB / PS/2 KVM Switch
		CS1716A	16 Port USB / PS/2 KVM Switch
	ALTUSEN	KH1508	8-Port High-Density KVM Switch
		KH1516	16-Port High-Density KVM Switch
		KH1508A	8-Port High Density KVM Switch*
		KH1516A	16-Port High Density KVM Switch*

Note: The CS1708i / CS1716i must be installed as the master switch when Daisy Chained with KH1508A or KH1516A switches.

Please keep in mind the following limitations when installing more than one KVM switch:

- ◆ The maximum distance between the CS1708i / CS1716i and the last switch in the daisy chain cannot exceed 150 meters, regardless of the number of switches in the daisy chain.
- ◆ The maximum distance between any two KVM switches in the daisy chain cannot exceed 15 meters.

Restoring Factory Default Settings

You can restore the factory default settings (listed on the next page) for the CS1708i / CS1716i. With this procedure, the administrator and all user accounts are removed from the system. All port names and setting are also removed.

-
- Note:** 1. A jumper cap is required when performing this procedure.
2. If your Administrator login information has become corrupted, or you have forgotten it), this procedure to reset the original defaults (see page 27).
-

1. Unplug the CS1708i / CS1716i's power adapter.
2. Place a jumper cap over pins 1-2 of the mainboard jumper labeled J17.

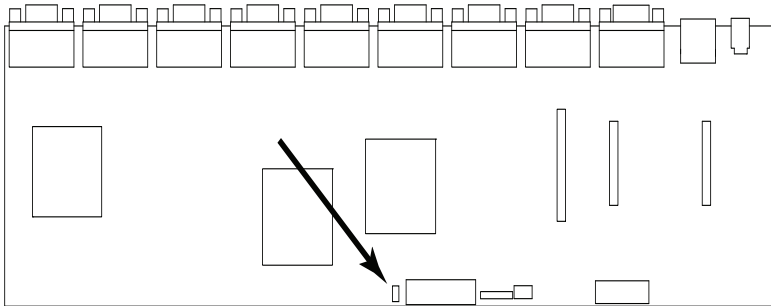

3. Plug in the power adapter. The following directions appear on the KVM console screen:

```
USERNAME AND PASSWORD INFORMATION AND PORT/USER  
INFORMATION HAS BEEN CLEARED. PLEASE POWER OFF THE  
SWITCH, REMOVE THE JUMPER, CLOSE THE CASE, THEN  
RESTART.
```

4. Unplug the power adapter again.
5. Remove the jumper cap from the jumper.
6. Close the housing and plug the power adapter in again.

After powering on the unit, you can use the default username and password to log in.

OSD Factory Default Settings

The factory default settings are as follows:

Setting	Default
OSD Hotkey	[Scroll Lock] [Scroll Lock]
Port ID Display Position	Upper Left Corner
Port ID Display Duration	3 Seconds
Port ID Display Mode	Port Number plus Port Name
Scan Duration	5 Seconds
Scan-Skip Mode	All
Screen Blanker	0 (Disabled)
Logout Timeout	0 (Disabled)
Beeper	Y (Activated)
Accessible Ports	F (Full) For all Users on all Ports

About SPHD Connectors



This product uses SPHD connectors for its KVM and/or Console ports. We have specifically modified the shape of these connectors so that only KVM cables that we have designed to work with this product can be connected.

Limited Warranty

IN NO EVENT SHALL THE DIRECT VENDOR'S LIABILITY EXCEED THE PRICE PAID FOR THE PRODUCT FROM DIRECT, INDIRECT, SPECIAL, INCIDENTAL, OR CONSEQUENTIAL DAMAGES RESULTING FROM THE USE OF THE PRODUCT, DISK, OR ITS DOCUMENTATION.

The direct vendor makes no warranty or representation, expressed, implied, or statutory with respect to the contents or use of this documentation, and especially disclaims its quality, performance, merchantability, or fitness for any particular purpose.

The direct vendor also reserves the right to revise or update the device or documentation without obligation to notify any individual or entity of such revisions, or update. For further inquiries, please contact your direct vendor.

Index

A

- Access Ports, 55
- Activate Beeper, 35
- ADM, 34
- Administration, 53
 - ANMS, 62
 - Customization, 69, 104
 - customization, 104
 - Firmware upgrading, 72
 - List Function, 86
 - Network, 55
- Administration Page, 97
- ANMS, 62, 102
- AP Operation
 - Java Client, 126
 - Windows Client, 121
- Authentication
 - external, 62, 102
- Auto Scan Mode, 43
- Auto Scanning, 38
 - Invoking Auto Scan, 43
 - Pausing Auto Scan, 43
 - Scan Duration, 32, 96
 - Stopping, 43

B

- Backup Configuration / User Accounts, 73
- Beeper, 96
 - Activate, 35
 - Hotkey Control, 45
- BRC, 37
- Broadcast Mode, 37
- Browser
 - Logging In, 49

C

- CC Management, 64
- Clear Port Names, 71

- Clear the Name List, 35
- Components
 - front panel, 8
 - rear panel, 10
- computer connection tables, 155
- Configuration
 - backup, 73
 - restore, 74
- Configuration Page
 - Windows Client, 95
- console cable installation, 20
- Control Panel, 77
- CS1708A / CS1716A
 - computer connection tables, 155
 - rear view, 11
- Customization, 69, 104

D

- Daisy chaining, 21
- default, 27
- Default username and password, 27
- desktop mounting, 14
- DNS Server, 56, 57

E

- EDID, 4
- Edit Port Names, 34
- External authentication, 62, 102

F

- F1 GOTO, 30
- F2 LIST, 31
- F3 SET, 32
- F4 ADM, 34
- F5 SKP, 36
- F6 BRC, 37
- F7 SCAN, 38
- F8 LOU, 39

- factory default settings, 158
 - restoring, 157
- Firmware upgrade, 72
 - OSD setting, 36
 - port, 130
 - recovery, 134

G

- General Information, 54, 97
- GOTO, 30
- GUI
 - recalling, 90
- GUI Hotkey, 96

H

- hardware requirements
 - cables, 6
 - computers, 5
 - consoles, 5
- Hot Plugging, 24
 - Console Ports, 24
 - KVM ports, 24
- Hot Plugging Stations, 24
- Hotkey
 - Beeper Control, 45
 - Command Mode, 33
 - OSD, 32, 96
 - Port Control, 40
 - Selecting the Active Port, 42
 - Summary Table, 47
- Hotkey Configuration Operations, 45
- Hotkey Invocation Keys
 - tooggling, 45
- Hotkey Mode
 - exiting, 41
 - invoking, 41
- Hotkey Setup, 79
- Hotkey setup, 79
- Hotkey Summary Table, 91

I

- Installation
 - daisy chaining, 21
 - single station, 19
- Invalid login, 50
- Invoking Hotkey Mode, 41
- IP
 - Address determination, 145
- IP Address, 34

J

- Java Applet Viewer, 107
- Java Client, 126
 - AP Login, 127
 - AP Operation, 127
 - Troubleshooting, 140

K

- Keyboard
 - On-Screen, 84
- Keyboard Emulation
 - Mac, 143
 - Sun, 144
- Keyboard Language, 36
- Keyboard Port Operation, 42
- KVM adapter cables, 6

L

- LDAP Settings, 64
- LIST, 31
- List Function, 86
- Local Console OSD, 27
- Log file, 111
- Log Server
 - Configure, 115
 - Events, 116
 - Installation, 113
 - Main Screen, 114, 119
 - Maintenance, 117
 - Menu Bar, 115
 - Options, 118
 - Search, 116

- Starting Up, 114
 - Tick Panel, 120
 - Log server, 66
 - Logging In, 49
 - Login
 - Invalid login, 50
 - Login Failure, 69
 - Login String, 61
 - Logout, 39
 - Logout Timeout, 34
 - LOUT, 39
- M**
- MAC
 - Address, 54
 - Main Page
 - Windows Client, 85
 - Main Webpage, 51
 - Main Webpage Elements, 52
 - Message Board
 - Windows Client, 82
 - mounting
 - desktop, 14
 - rack, 14
 - Mouse Sync Mode, 70
- N**
- Network, 55, 101
- O**
- Online
 - Registration, iii
 - On-Screen Keyboard, 84
 - Operation
 - AP, 121
 - OSD
 - Configuration Page, 95
 - factory default settings, 158
 - Functions, 30
 - Hotkey, 27, 32
 - Local Console, 27
 - Logout, 39
 - Main Page, 85
 - Main Screen, 28
 - Main Screen Headings, 29
 - Navigation, 29
 - Toolbar, 90
 - OSD Hotkey
 - toggling, 46
- P**
- Panel Array Mode
 - Windows Client, 93
 - Password, 27
 - Pause, 38
 - Port
 - Selection, 23
 - Port Access, 99
 - Port control
 - hotkeys, 40
 - Port ID
 - Display Duration, 32
 - Display Mode, 32, 96
 - Display Position, 32
 - Numbering, 25
 - Port Names, 34, 88
 - Port names
 - clearing, 71
 - Port Operating System
 - setting, 46
 - Port operation
 - Windows Client, 90
 - ports
 - quick view, 35
 - set operating system, 35
 - Powering Off and Restarting, 25
- Q**
- quick view ports, 35
- R**
- rack mounting, 14
 - front, 15
 - rear, 17

safety information, 137

RADIUS

examples, 64

RADIUS Settings, 63

Recalling the GUI, 90

Requirements

General, 5

Reset Default Values, 71

Reset on Exit, 71

Reset Station IDs, 35

Restore Configuration / User Accounts, 74

Restore Default Values, 35

restoring factory defaults, 157

RoHS, ii

S

safety instructions

general, 135

rack mounting, 137

SCAN, 38

Scan

Duration, 96

Select, 96

Scan Duration, 32

SCAN/SKIP MODE, 33

Screen Blanker, 33, 96

Security, 59, 103

Login string, 61

Selecting the Active Port, 42

Serial number, 126

serial number, 122

SET, 32

Quick View Ports, 35

Single station installation, 19

SJ/T 11364-2006, ii

Skip Mode, 36, 44

Specifications, 154

stacking, 14

Station IDs

Reset, 35

T

Technical Support, 138

Telephone support, iii

Tick Panel, 120

Time out control, 69

Toolbar

OSD, 90

Panel Array Mode (Windows), 93

Troubleshooting, 139

General operation, 139

Java Client, 140

Log Server, 142

Panel Array Mode, 142

Sun Systems, 141

Windows Client, 140

Trusted Certificates, 151

U

User Accounts

backup, 73

restore, 74

User Management, 67, 98

User Notice, iii

User Station Filters, 59

Username

default, 27

V

Video DynaSync, 4

Video Settings

Windows Client, 81

W

Windows Client

AP Installation, 121

AP Login, 124

AP Operation, 125

Message Board, 82

Toolbar, 90

Troubleshooting, 140

Windows Client Viewer, 75

Working Mode, 70