



# Ergotron® FX Series

## low-profile mounting solution



### Highlights

- Places monitor less than 1" from wall (FX30 & FX75); 3-1/2" for the FXT75
- Allows monitor or large display to be attached to or removed from wall quickly and easily
- Solid and stable platform for touch-screen monitor compatibility
- Maximum weight capacities up to 75 lbs (34.1 kg) for select configurations
- Steel construction for long-lasting durability
- FX Series products can be attached to most any sturdy vertical surface such as machines, walls, cabinets, etc. The FX75 and FXT75 also may be pole mounted or used with the Ergotron Command Post
- VESA® Flat Display Mounting Interface (FDMI™) Standard compliant for easy monitor attachment
- LIFETIME warranty; five-year warranty on FXT75 pivot

The FX Series products FX30, FX75, and FXT75 allow a flat panel monitor or large display to be mounted to a vertical surface like a picture hung on a wall. Once installed, these modules provide a rock-solid platform, even for monitors with touch-screen capability. To remove a monitor from the wall, the user simply moves the quick-release lever to the side and lifts off the monitor. Reinstallation is just as easy!

The FXT75 provides for up to 25 degrees (+20°/-5°) of tilt capability for large displays weighing between 30 and 75 lbs. The unique patent pending tilt mechanism design provides for smooth (finger-touch) continuous tilt adjustment whether wall or pole mounted.

## FX30 Mounting Bracket:

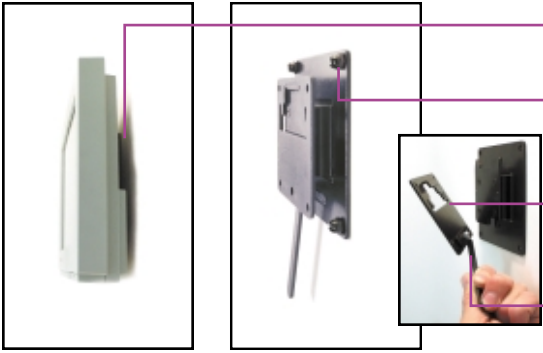

*FX30 places monitor only .77" (20 mm) from wall for an extremely low profile.*

*Mounts directly to surface, (fasteners for mounting unit to wall are customer supplied).*

*VESA® MIS-D, 100/75, C Standard plate attaches directly to the back of compliant monitors.*

*Quick-release lever for easy attachment and removal of monitor.*

Both the 75 mm and 100 mm Interfaces ship standard with product.

75 mm Interface

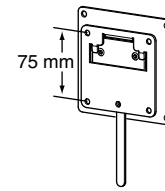

100 mm Interface

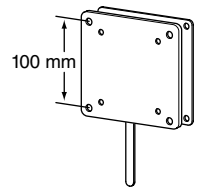

Fasteners for mounting unit to wall are customer supplied.

## FX75 Mounting Bracket:

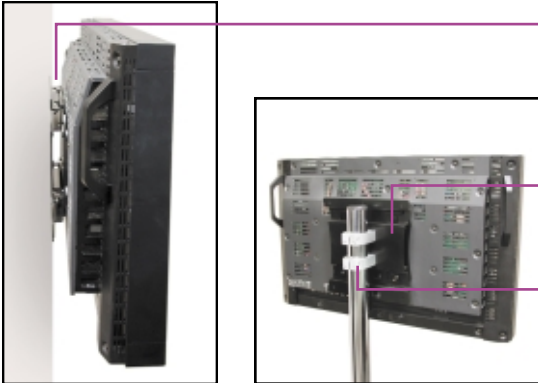

*FX75 places display less than 1" (25 mm) from wall for an extremely low profile. Unique quick-connect design latches monitor in place with touch-screen stability.*

*VESA® MIS-E, C Standard plate attaches directly to the back of compliant monitors.*

*FX75 may be mounted directly to a vertical surface, pole, or Ergotron Command Post.*

FX75: Standard VESA MIS-E, 100 x 200 mm monitor mounting. For custom interfaces, contact Ergotron.

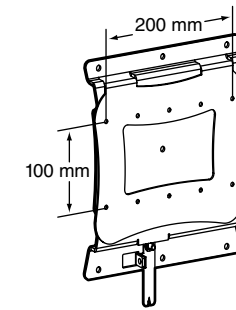

Fasteners for mounting unit to wall are customer supplied.

## FXT75 Mounting Bracket:

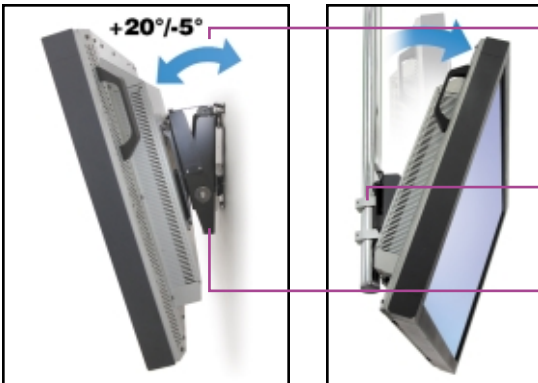

*The FXT75 (patent pending) tilt mechanism allows the monitor to tilt forward 20 degrees and tilt backwards five degrees all with a smooth (finger-touch) motion.*

*FXT75 may be mounted directly to a vertical surface, pole, or Ergotron Command Post.*

*FXT75 places display less than 3-1/2" (89 mm) from wall for a low profile.*

FXT75: Standard VESA MIS-E, 100 x 200 mm monitor mounting. For custom interfaces, contact Ergotron.

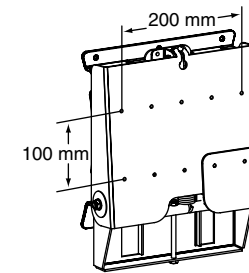

Fasteners for mounting unit to wall are customer supplied.

## Basic Specifications:

### Application Options:

- FX30: Vertical Surfaces
- FX75 & FXT75: Vertical Surfaces, Command Posts, Pole Mounting

### Monitor Interface Options:

- FX30: VESA MIS-D, 100/75, C
- FX75 & FXT75: VESA MIS-E, C
- Custom Interface Brackets: contact Ergotron for details and availability

### Weight Capacity:

- FX30: 30 lbs (13.6 kg)
- FX75: 75 lbs (34 kg)
- FXT75: 30-75 lbs (13.6-34 kg)\*

\*Weight capacity of 75 lbs (34 kg) assumes a monitor/display thickness of 5-1/2" (140 mm). For further information regarding the weight capacity of the FXT75, see the Flat Panel Orderguide (870-03-005) on our website.

**Accessory Options (mounted separately):** Pole-Mount Brackets, Command Post Brackets, Keyboard Holders, Wrist Rests, Mouse Pads, Mouse Pouches, CPU Holders, Surge Suppressors and Power Strips

© 2004 Ergotron, Inc.  
rev. 02/26/2004 870-05-034

**Ergotron, Inc.:** St. Paul, MN; (800) 888-8458;  
[www.ergotron.com](http://www.ergotron.com); [sales@ergotron.com](mailto:sales@ergotron.com)

**Ergotron Europe:** Amsterdam, The Netherlands;  
Tel. +31 20 312.29.39; [info.eu@ergotron.com](mailto:info.eu@ergotron.com)

**Ergotron Canada:** Calgary, Alberta;  
(800) 267-9912; [info.ca@ergotron.com](mailto:info.ca@ergotron.com)

