



Slim 22G

Applications

- | Recreational Vehicles
- | Transportation Connectivity
- | Enterprise Branch



TAA
COMPLIANT



Ultra Wide Bandwidth

Wide frequency range (600-6000MHz) supporting LTE and 5G connectivity.

Built for 5G

Omni-directional 2x2 MIMO mobile antenna for the best performance.

Wi-Fi

2x2 MIMO dual band (2.4GHz & 5GHz) high gain omnidirectional antennas for local coverage.





Low Profile Design

High performance in a small, durable housing.

Easy Installation

Can be mounted on a window or wall or hidden under a vehicle dashboard.



Specification

Cellular

Antenna Elements	2 elements
Peak Gain & Frequencies	4.1dBi: 617-960MHz 4.3dBi: 1710-2700MHz 6.0dBi: 3400-4200MHz 7.5dBi: 5000-6000MHz
VSWR	<2.5 over 90% of the band
Feed Power Handling	10W
Input Impedance	50 Ω
Polarisation	Linear

GPS

Frequency Range	1561-1602 MHz
Peak Gain	0.5dBi @ 1575MHz 1.6dBi @ 1602MHz
VSWR	< 2
Output Return Loss	10dB max
Gain: LNA	28 ±3dB
Noise Figure	1.5dB max at 3.3V
Operating Voltage	3.3V
Power Consumption	8.5 ±2.5mA at 3.3V

Wi-Fi

Antenna Elements	2 elements
Peak Gain & Frequencies	5.5dBi: 2400-2500MHz 5.7dBi: 5000-6000MHz
VSWR	< 2.0
Feed Power Handling	10W
Input Impedance	50 Ω
Polarisation	Linear

Cable (Cellular / Wi-Fi)

Type	CFD-200 (Cellular, Wi-Fi)
Loss	0.33 dB/m @ 900 MHz 0.49 dB/m @ 2000 MHz 0.55 dB/m @ 2500 MHz 0.87 dB/m @ 5800 MHz
Diameter	0.2" / 5.0mm
Jacket	Half matt PVC, UV resistant
Termination	SMA male and RP-SMA male

Cable (GPS)

Type	RG-174 (GPS)
Loss	3.4 dB/m @ 1000 MHz 4.9 dB/m @ 1800 MHz
Diameter	0.1" / 2.7mm
Jacket	Half matt PVC, UV resistant
Termination	SMA male

Specification

Mounting

Supported Types Window, wall

Package contents

Antenna Slim 22G

Accessories Velcro strip (hook and loop fastener)
(4pcs, length 4.7' / 120mm)

Mechanical

Product Dimensions 7.09"x5.12"x0.59" / 180x130x15mm

Packaged Dimensions 9.61"x3.15"x9.84" / 244x80x250mm

Enclosure Material UV stable PC

Color Black

Environmental, compliance

IP Rating IP55

Operating Temperature -40° - 176°F /
-40° - 80°C

Storage Temperature -40° - 176°F /
-40° - 80°C

Compliance ROHS, REACH, WEEE

Enclosure Flammability UL 94 HB

Cable Flammability UL 758 (VW-1)

UV Resistance UL 746C (F1 long-term UV exposure)

Ordering Information

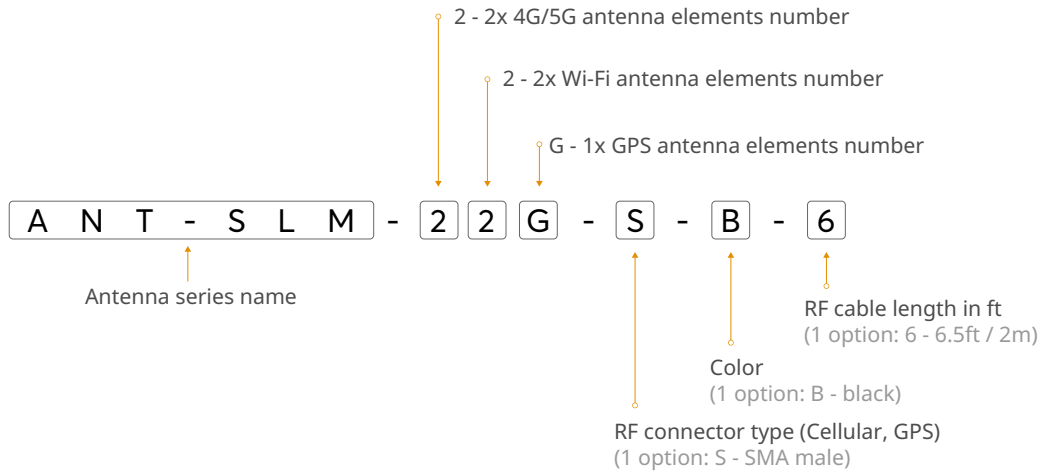

Product Code

ANT-SLM-22G-S-B-6

Description

2x LTE/5G, 2x Wi-Fi, 1x GPS 600-6000MHz, SMA male (Cellular, GPS), RP-SMA male (Wi-Fi), Black, 6.5ft / 2m

Technical Drawing

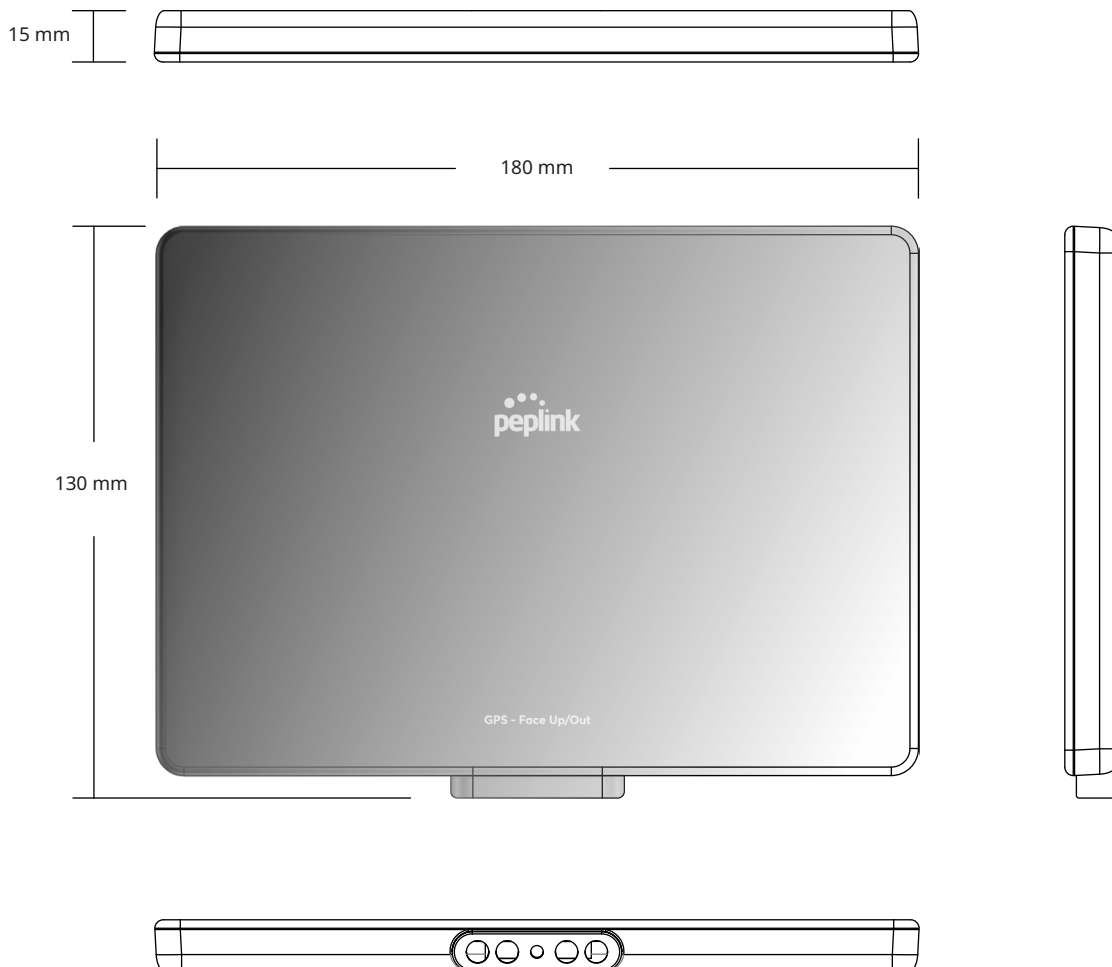

Cellular Antenna Performance

Cellular Antenna VSWR

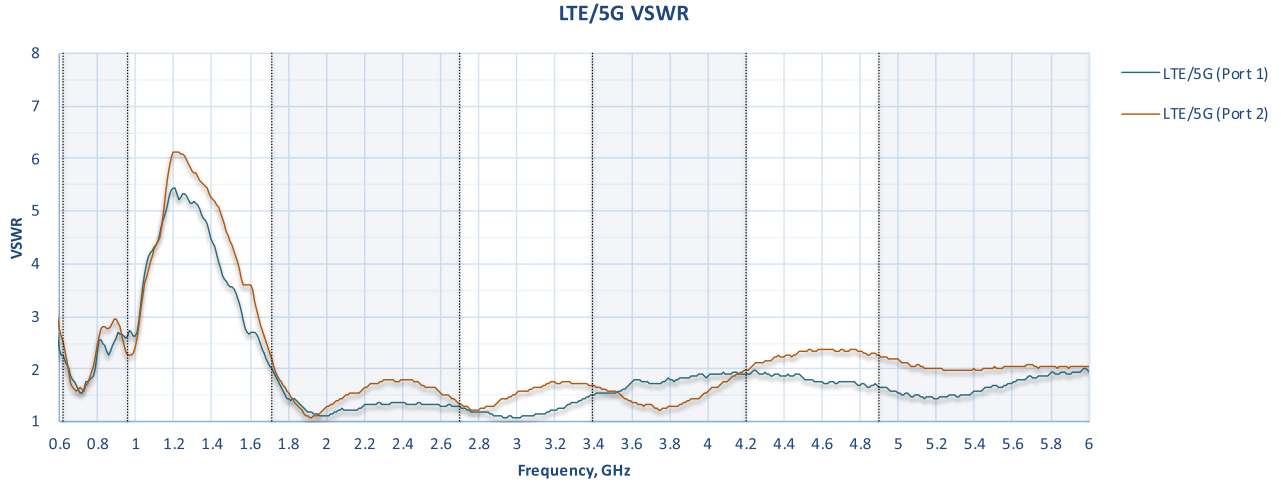

Cellular Antenna Gain

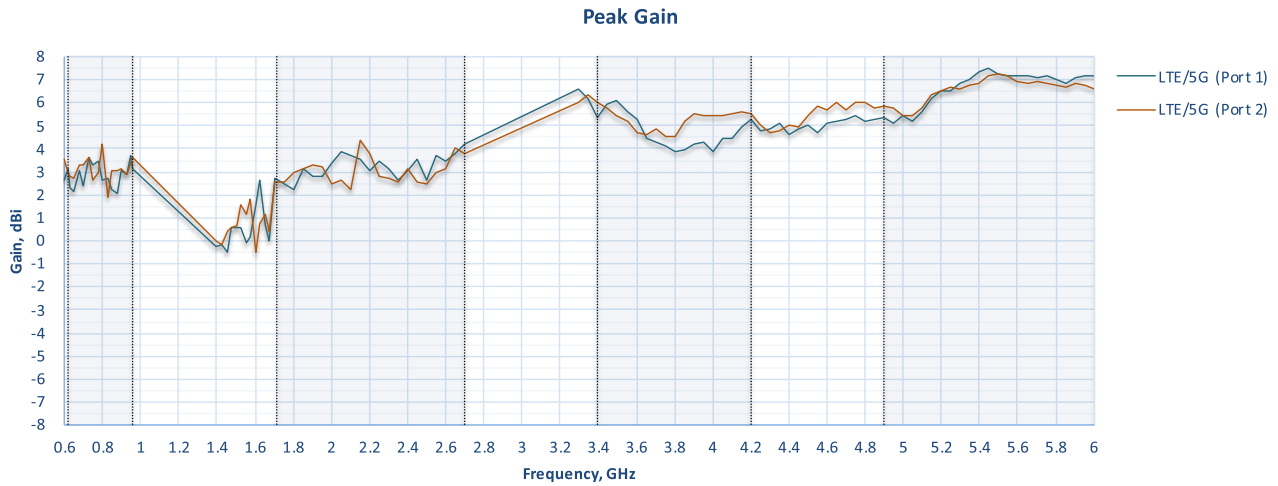

Cellular Antenna Efficiency

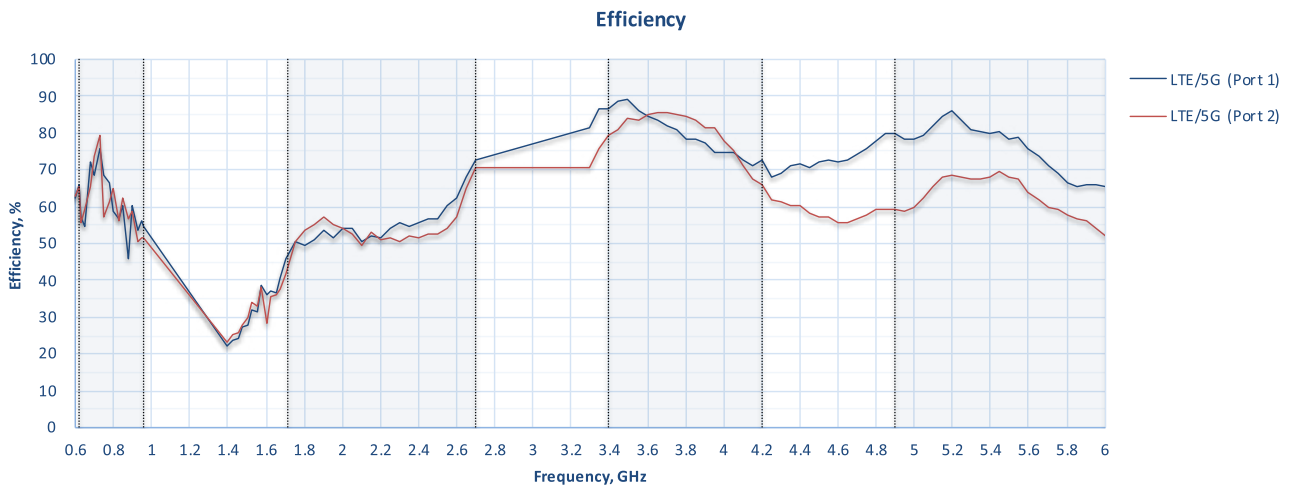

Wi-Fi Antenna Performance

Wi-Fi Antenna VSWR

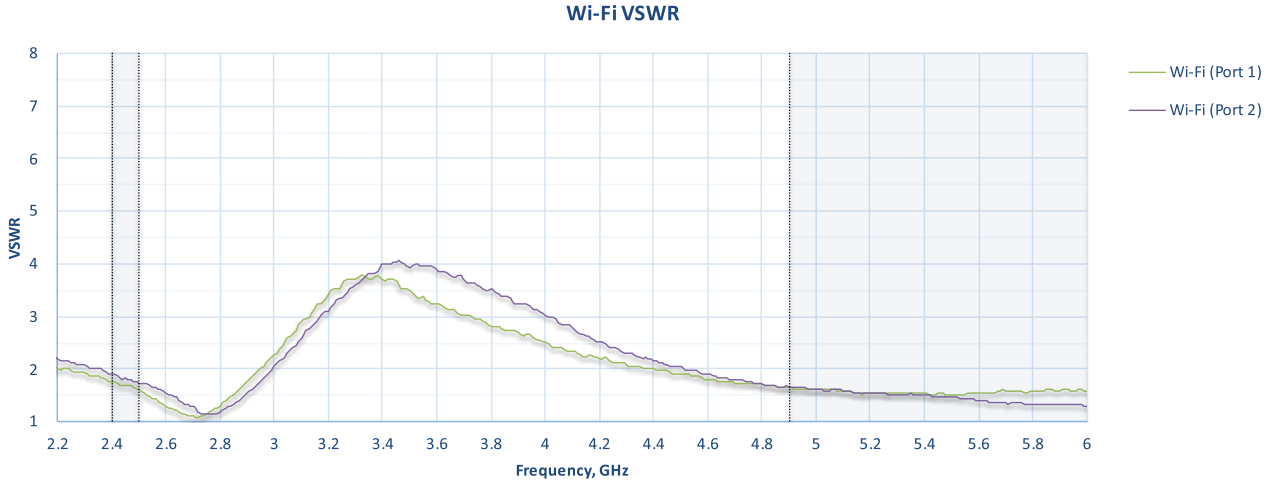

Wi-Fi Antenna Gain

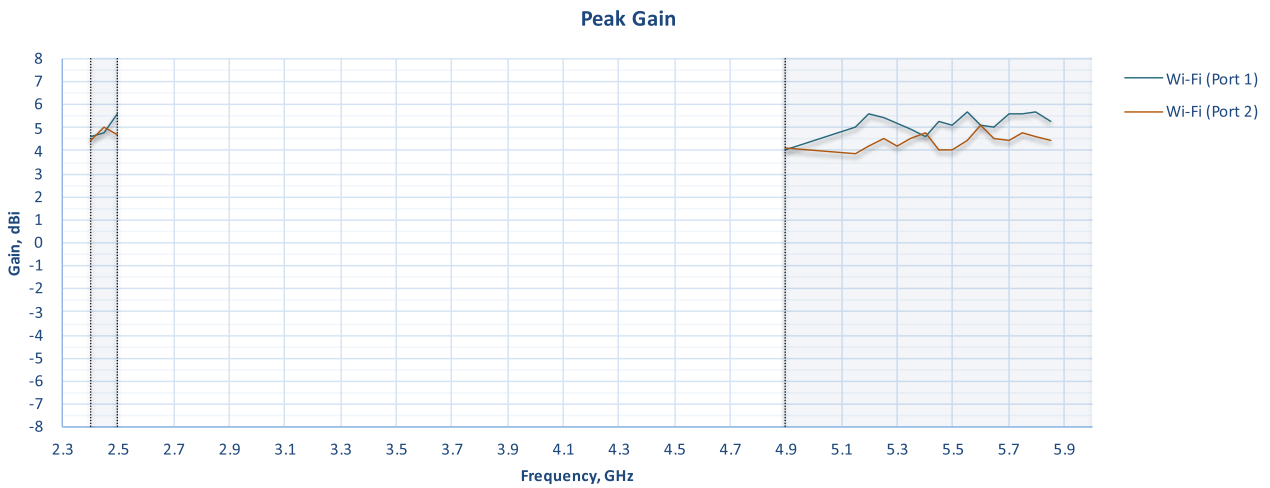

Wi-Fi Antenna Efficiency

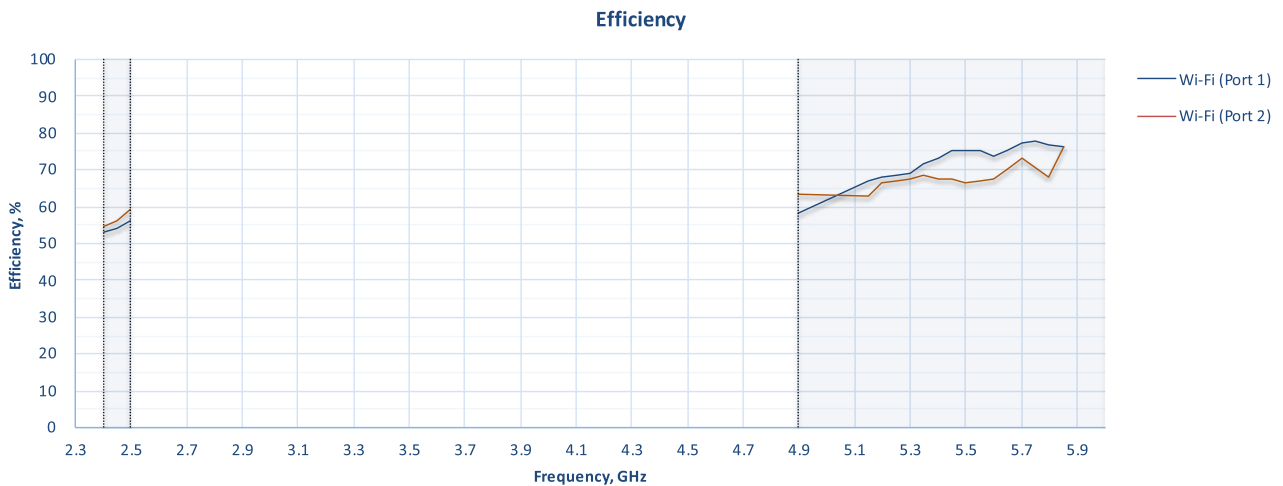

Cellular & Wi-Fi Antenna Performance

Cellular & Wi-Fi Antenna Isolation

LTE/5G and Wi-Fi antenna elements isolation

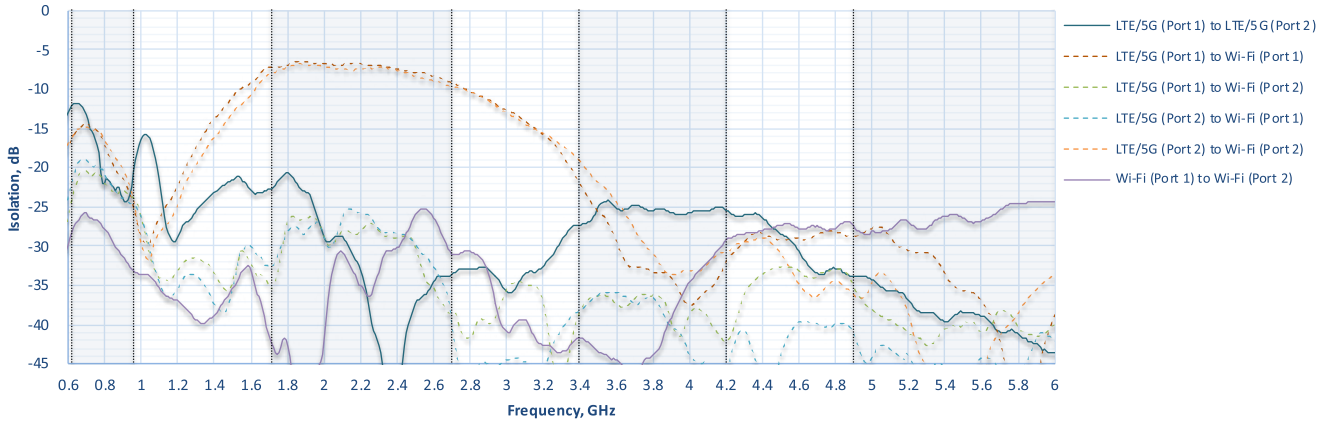

Radiation Pattern

LTE Radiation Patterns (Azimuth)

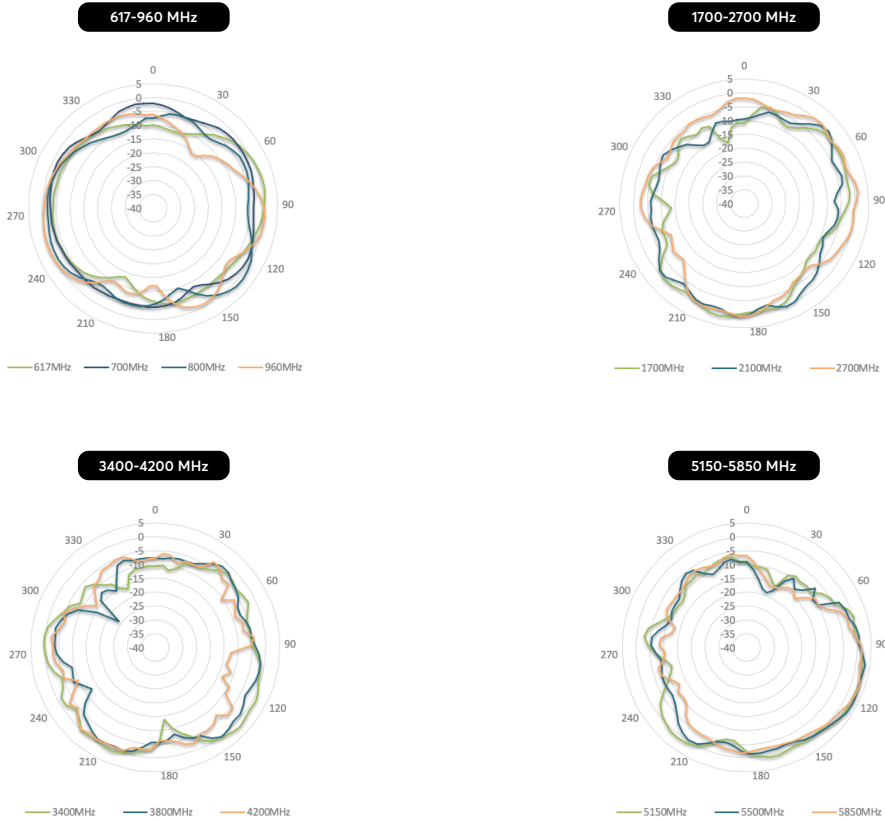

Radiation Pattern

LTE Radiation Patterns (Elevation 1)

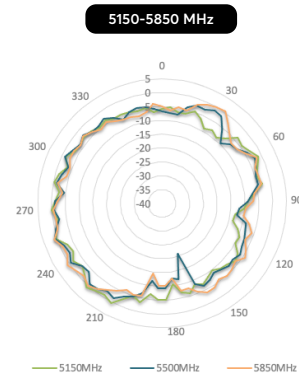
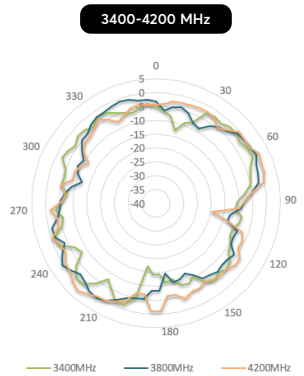
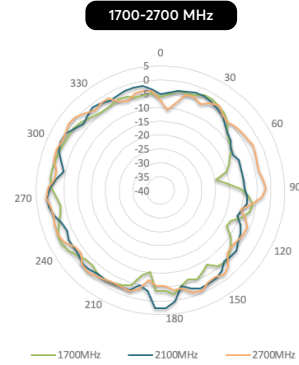
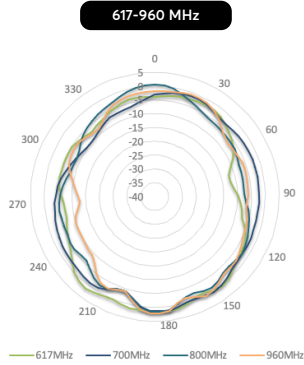

LTE Radiation Patterns (Elevation 2)

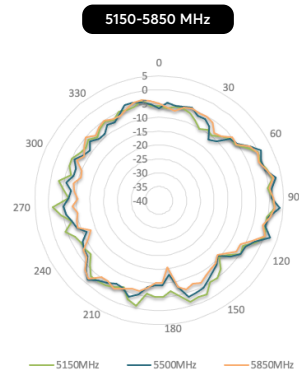
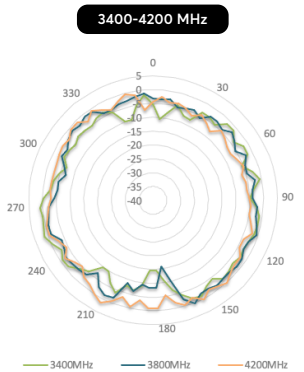
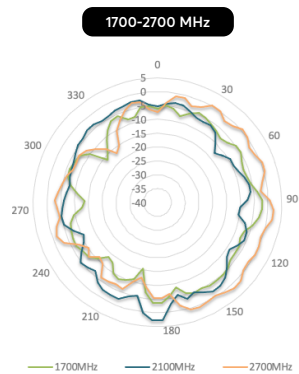
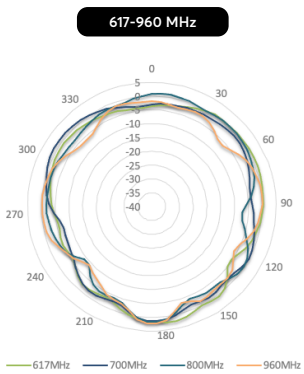

Radiation Pattern

Wi-Fi Radiation Patterns (Azimuth)



Wi-Fi Radiation Patterns (Elevation 1)

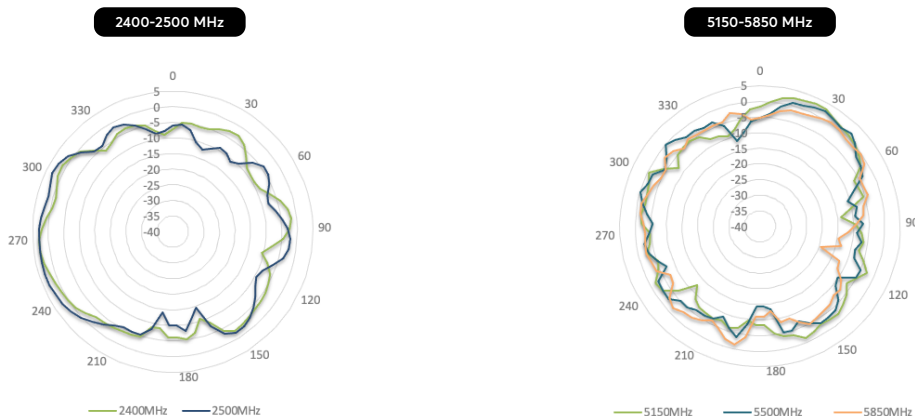

Wi-Fi Radiation Patterns (Elevation 2)

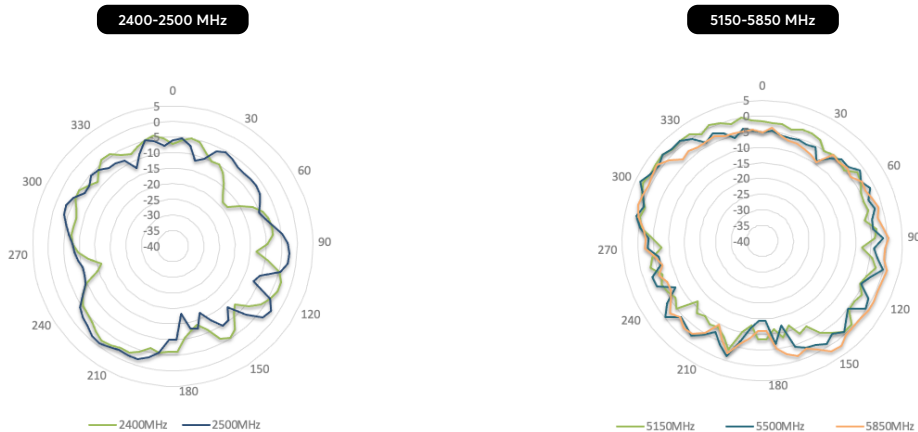

Installation Recommendation

Step 1

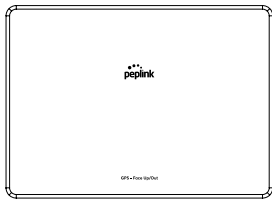

This side face the sky

Velcro strip
(hook and loop fastener)



Step 2

window
or wall

