



# QSG OTD144

Main Page > OTD Outdoor routers > OTD144 > **QSG OTD144**

This Wiki page contains the online version of the **Quick Start Guide (QSG)** for the **OTD144 Outdoor Router**. Here you will find an overview of the various components on the front and back of a OTD144 device, hardware installation instructions, first login information, device specifications, and general safety information. It is highly recommended to acquaint yourself with the Quick Start Guide before using the device. You can also locate a printed version of the Quick Start Guide in the packaging box of your device.



## Safety information

Before starting operating the device, please review recommendations and precautions to minimize the possibility of accidents. Safety precautions presented are supplementary and subject to the local safety regulations. When various operations are executed on the device, the user must fully follow the safety instructions and recommendations provided with the device.

## General

Technical specifications	
Input voltage range	42.5–57.0 VDC, reverse polarity protection, voltage surge/transient protection
Radio specifications	
RF technologies	WiFi, 2G, 3G, 4G
Max RF power	33 dBm@GSM, 23dBm @WCDMA, 23 dBm@LTE, 20 dBm@WiFi 2.4G
Integrated antennas specifications	
Mobile antennas	Internal 2 x 698–960 / 1710 ~ 2690MHz, 50 Ω, VSWR<3.5, gain 1 / 4.5 dBi, omnidirectional
Wi-Fi antennas	Internal 2x 2400-2500 MHz, 50 Ω, VSWR < -6.9 dB, gain <4.9 dBi, omnidirectional

\* Order code dependant.

OTD144 outdoor router must be used in compliance with any and all applicable national and international laws and with any special restrictions regulating the utilization of the communication module in prescribed applications and environments.

## PoE standards

















This device uses PoE alternative B.

## The difference between PoE alternative A and alternative B

### Alternative A:

802.3af and 802.3at Alternative A connection. The power sourcing equipment applies a positive voltage to pins 1-2 and a negative voltage to pins 3-6.

















**802.3af/at Alternative A:**

Pins at switch	T568A Color	T568B Color	10/100 Alternative A, mixed DC & data		1000 (1 gigabit) Alternative A, DC & bi-data	
Pin 1	 white/green stripe	 white/orange stripe	Rx +	DC +	TxRx A +	DC +
Pin 2	 green solid	 orange solid	Rx -	DC +	TxRx A -	DC +
Pin 3	 white/orange stripe	 white/green stripe	Tx +	DC -	TxRx B +	DC -
Pin 4	 blue solid	 blue solid	Unused	Unused	TxRx C +	
Pin 5	 white/blue stripe	 white/blue stripe	Unused	Unused	TxRx C -	
Pin 6	 orange solid	 green solid	Tx -	DC -	TxRx B -	DC -
Pin 7	 white/brown stripe	 white/brown stripe	Unused	Unused	TxRx D +	
Pin 8	 brown solid	 brown solid	Unused	Unused	TxRx D -	

**Alternative B:**

802.3af and 802.3at Alternative B connection. The power sourcing equipment applies a positive voltage to pins 4-5 and a negative voltage to pins 7-8.

**802.3af/at Alternative B:**

Pins at switch	T568A Color	T568B Color	10/100 Alternative B, DC on spares		1000 (1 gigabit) Alternative B, DC & bi-data	
Pin 1	 white/green stripe	 white/orange stripe	Rx +		TxRx A +	
Pin 2	 green solid	 orange solid	Rx -		TxRx A -	
Pin 3	 white/orange stripe	 white/green stripe	Tx +		TxRx B +	
Pin 4	 blue solid	 blue solid		DC +	TxRx C +	DC +
Pin 5	 white/blue stripe	 white/blue stripe		DC +	TxRx C -	DC +
Pin 6	 orange solid	 green solid	Tx -		TxRx B -	
Pin 7	 white/brown stripe	 white/brown stripe		DC -	TxRx D +	DC -
Pin 8	 brown solid	 brown solid		DC -	TxRx D -	DC -

**CE Declaration of Conformity**

<b>[BG] Bulgarian</b>	С настоящето, TELTONIKA NETWORKS декларира, че OTD144 е в съответствие със съществените изисквания и другите приложими разпоредби на Директива 2014/53/EU
<b>[HR] Croatian</b>	Ovim TELTONIKA NETWORKS izjavljuje da je ovaj OTD144 u skladu s bitnim zahtjevima i ostalim relevantnim odredbama Direktive 2014/53/EU
<b>[CZ] Czech</b>	TELTONIKA NETWORKS tímto prohlašuje, že OTD144 splňuje základní požadavky a všechna příslušná ustanovení Směrnice 2014/53/EU
<b>[DK] Danish</b>	Undertegnede TELTONIKA NETWORKS erklærer herved, at følgende udstyr OTD144 overholder de væsentlige krav og øvrige relevante krav i direktiv 2014/53/EU
<b>[NL] Dutch</b>	Hierbij verklaart TELTONIKA NETWORKS dat het toestel I OTD144 in overeenstemming is met de essentiële eisen en de andere relevante bepalingen van richtlijn 2014/53/EU
<b>[EE] Estonian</b>	Käesolevaga kinnitab TELTONIKA NETWORKS seadme OTD144 vastavust direktiivi 2014/53/EU põhinõuetele ja nimetatud direktiivist tulenevatele teistele asjakohastele sätetele
<b>[FI] Finnish</b>	TELTONIKA NETWORKS vakuuttaa täten että OTD144 tyyppinen laite on direktiivin 2014/53/EU oleellisten vaatimusten ja sitä koskevien direktiivin muiden ehtojen mukainen
<b>[FR] French</b>	TELTONIKA NETWORKS déclare que cette OTD144 est conforme aux exigences essentielles et aux autres dispositions pertinentes de la directive 2014/53/EU
<b>[DE] German</b>	Hiermit erklärt TELTONIKA NETWORKS, dass dieser OTD144 den grundlegenden Anforderungen und anderen relevanten Bestimmungen der Richtlinie 2014/53/EU entspricht
<b>[GR] Greek</b>	ΜΕ ΤΗΝ ΠΑΡΟΥΣΑ Ο ΚΑΤΑΣΚΕΥΑΣΤΗΣ TELTONIKA NETWORKS ΔΗΛΩΝΕΙ ΟΤΙ OTD144 ΣΥΜΜΟΡΦΩΝΕΤΑΙ ΠΡΟΣ ΤΙΣ ΟΥΣΙΩΔΕΙΣ ΑΠΑΙΤΗΣΕΙΣ ΚΑΙ ΤΙΣ ΛΟΙΠΕΣ ΣΧΕΤΙΚΕΣ ΔΙΑΤΑΞΕΙΣ ΤΗΣ ΟΔΗΓΙΑΣ 2014/53/EU
<b>[HU] Hungarian</b>	A TELTONIKA NETWORKS ezzenel kijelenti, hogy a OTD144 típusú berendezés teljesíti az alapvető követelményeket és más 2014/53/EU irányelvben meghatározott vonatkozó rendelkezéseket
<b>[IE] Irish</b>	Leis seo, dearbhaíonn TELTONIKA NETWORKS go gcomhlíonn an OTD144 seo bunriachtanais agus forálacha ábhartha eile Threoir 2014/53/EU
<b>[IT] Italian</b>	Con la presente, TELTONIKA NETWORKS dichiara che questo OTD144 è conforme ai requisiti essenziali e ad altre disposizioni pertinenti della Direttiva 2014/53/EU
<b>[LV] Latvian</b>	Ar šo TELTONIKA NETWORKS deklarē, ka OTD144 atbilst Direktīvas 2014/53/EU būtiskajām prasībām un citiem ar to saistītajiem noteikumiem
<b>[LT] Lithuanian</b>	Šiuo dokumentu UAB TELTONIKA NETWORKS deklaruoja, kad šis OTD144 atitinka esminius reikalavimus ir kitas 2014/53/EU Direktyvos nuostatas
<b>[MT] Maltese</b>	Hawnhekk, TELTONIKA NETWORKS tiddikjara li dan l-OTD144 huwa konformi mar-rekwiżiti essenzjali u idispożizzjonijiet rilevanti oħra tad Direttiva 2014/53/EU
<b>[NO] Norwegian</b>	TELTONIKA NETWORKS Erklærer herved at OTD144 er i samsvar med de grunnleggende krav og øvrige relevante krav i direktiv 2014/53/EU
<b>[PL] Polish</b>	Niniejszym TELTONIKA NETWORKS deklaruje że OTD144 jest zgodny z zasadniczymi wymaganiami i innymi właściwymi postanowieniami Dyrektywy 2014/53/EU
<b>[PT] Portuguese</b>	Eu, TELTONIKA NETWORKS declaro que o OTD144 cumpre os requisitos essenciais e outras provisões relevantes da Directiva 2014/53/EU
<b>[RO] Romanian</b>	Prin prezenta, TELTONIKA NETWORKS declară că aparatul OTD144 este în conformitate cu cerințele esențiale și cu alte prevederi pertinente ale Directivei 2014/53/EU
<b>[SK] Slovak</b>	Spoločnosť TELTONIKA NETWORKS týmto vyhlasuje, že smerovač OTD144 je v súlade so základnými požiadavkami a ďalšími príslušnými ustanoveniami smernice 2014/53/EU
<b>[SI] Slovenian</b>	TELTONIKA NETWORKS izjavlja, da je ta OTD144 v skladu z bistvenimi zahtevami in drugimi relevantnimi določili direktive 2014/53/EU
<b>[ES] Spanish</b>	Por la presente, TELTONIKA NETWORKS declara que este OTD144 cumple con los requisitos esenciales y otras exigencias relevantes de la Directiva 2014/53/EU
<b>[SE] Swedish</b>	Härmed intygar TELTONIKA NETWORKS att denna OTD144 är i överensstämmelse med de väsentliga egenskapskrav och övriga relevanta bestämmelser som framgår av direktiv 2014/53/EU

Detailed compliance information is available at the following internet address: [wiki.teltonika-networks.com/view/Certificates](https://wiki.teltonika-networks.com/view/Certificates) (<https://wiki.teltonika-networks.com/view/Certificates>).



This sign means that it is necessary to read the User's Manual before you start using the device.



This sign on the package means that all used electronic and electric equipment should not be mixed with general household waste.



Hereby, TELTONIKA NETWORKS declares that this OTD144 is in compliance with the essential requirements and other relevant provisions of Directive 2014/53/EU. The full text of the EU declaration of conformity is available at the following internet address: [https://wiki.teltonika-networks.com/view/OTD144\\_CE/RED](https://wiki.teltonika-networks.com/view/OTD144_CE/RED).



Hereby, TELTONIKA NETWORKS declares that the radio equipment type OTD144 is in compliance with Radio Equipment Regulations 2017. The full text of the UK declaration of conformity is available at the following internet address: [https://wiki.teltonika-networks.com/view/OTD144\\_UKCA](https://wiki.teltonika-networks.com/view/OTD144_UKCA).

## Operating conditions

- Operating temperature: -40° to +75° Celsius
- Humidity should be in the range of 10% to 90% (non-condensing).
- Away from heat source, corrosive substances, salts, and flammable gases

**Attention:** operation outside the permissible range can considerably shorten the service life of the device.

## Faulty and damaged products

---

- Do not attempt to disassemble the device or its accessories.
- Only qualified personnel must service or repair the device or its accessories.
- If your device or its accessories have been submerged in water punctured or subjected to a severe fall, do not use until they have been checked at an authorized service center.

## Electrical safety

---

- Only use approved accessories.
- Do not connect with incompatible products or accessories.
- It is recommended to ground devices with grounding terminals before connecting them to power. Failure to ground appropriately might result in a shock hazard. The cross-sectional area of the protective grounding conductor should be at least 1mm<sup>2</sup>.

## Product handling

---

- You alone are responsible for how you use your device and any consequences related to its use.
- Use of your device is subject to safety measures designed to protect users and their environment.
- Always treat your device and its accessories with care.
- Do not expose your device or its accessories to open flames, lit tobacco products, liquid, or high humidity.
- Do not drop, throw or try to bend your device or its accessories.
- Do not use harsh chemicals, cleaning solvents, or aerosols to clean the device or its accessories.
- Do not paint your device or its accessories.
- Do not attempt to disassemble your device (exemptions for devices that require disassembly for SIM insertion) or its accessories: it does not contain any user-serviceable parts. For safety reasons, the equipment should be opened only by qualified personnel.
- Make sure to use ESD personal protective equipment while the equipment is serviced.
- Do not use your device in an enclosed environment where heat dissipation is poor.
- Prolonged use in such space may cause excessive heat and raise ambient temperature, which will lead to the automatic shutdown of your device or the disconnection of the mobile network connection for your safety. To use your device again after such a shutdown, cool it in a well-ventilated place before turning it on.
- Please check all national laws and local regulations for the disposal of electronic products.
- Do not operate the device where ventilation is restricted.
- Do not use or install this product near water to avoid fire or shock hazards.
- Arrange power and Ethernet cables so that they are not likely to be stepped on or have items placed on them.
- Ensure that the voltage and the rated current of the power source match the device's requirements. Do not connect the device to an inappropriate power source.
- During a thunderstorm, no operations should be carried out on the device and cables.
- The unit must be powered off where blasting is in progress and explosive atmospheres are present or near medical life support equipment.
- Do not leave your device and its accessories within reach of small children or allow them to play with it. They could hurt themselves or others and could accidentally damage the device. Your device contains small parts with sharp edges that may cause an injury choking hazard.
- Like any wireless device, this device operates using radio signals, which cannot guarantee connection in all conditions. Therefore, you must never rely solely on any wireless device for emergency communications or otherwise use the device in situations where the interruption of data connectivity could lead to death, personal injury, property damage, data, or other loss.
- The device may become warm during regular use.

## Front view

---

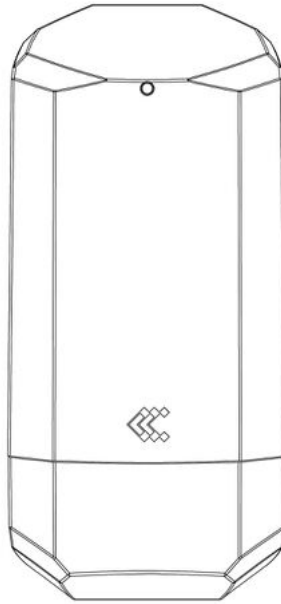

## Back view

---

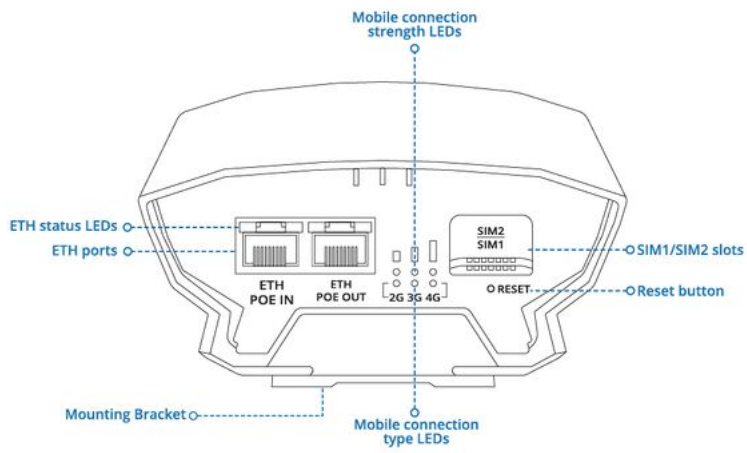

## OTD144 ETH Ports

---

0:00

## OTD144 Mounting Bracket

---

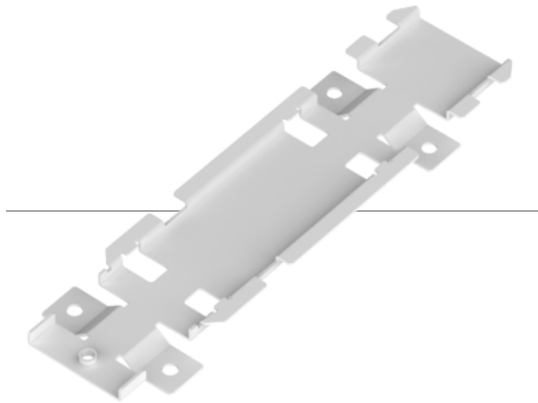

## Hardware installation

---

1. Remove the bottom case cover from the OTD140.

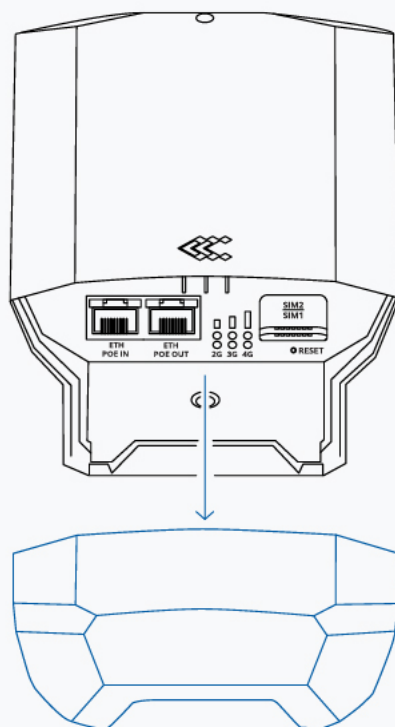

**3. Connect one end of the LAN cable to the Ethernet PoE-in port located on the bottom of the OTD140, and the other end to the power PoE port of the PoE injector. Then, plug the PoE injector into an electrical outlet.**

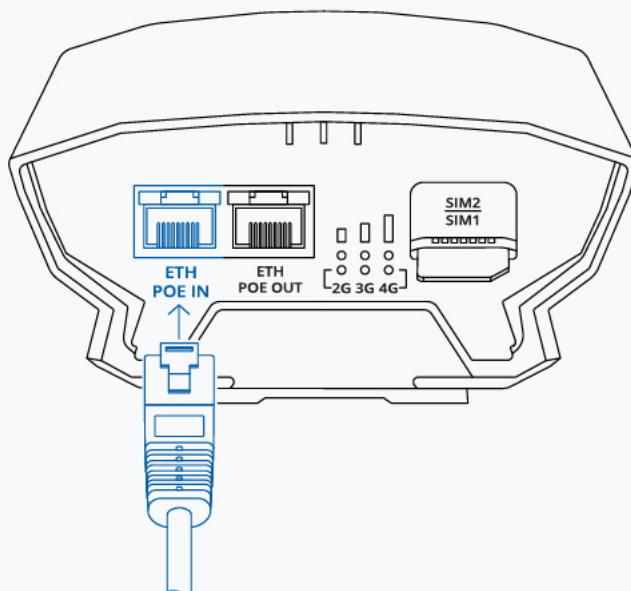

## Configure your computer LAN (Windows)

1. Ensure the Network connection is Enabled. Go to Start — Control Panel — Network and Internet — Network and Sharing Center. Click on the **Change adapter settings** in the left panel, then right-click on Network Adapter, and select Enable.

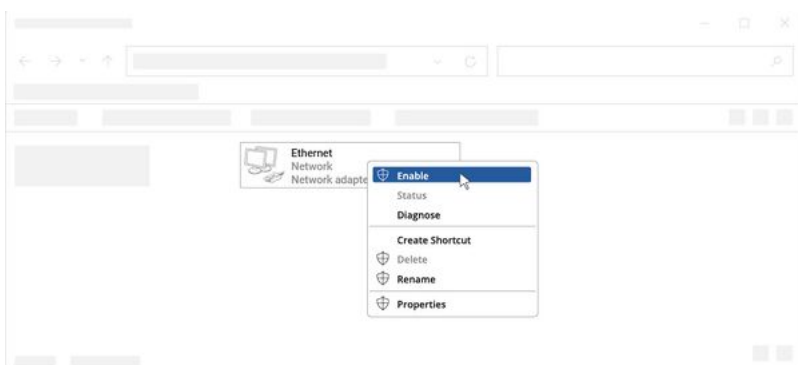

2. Check if IP and DNS are obtained automatically. Right-click on Network Adapter and select Properties. Then select **Internet Protocol Version 4** and click Properties.
3. If not selected, check to **obtain an IP address** and **obtain DNS server address automatically**. Click OK.

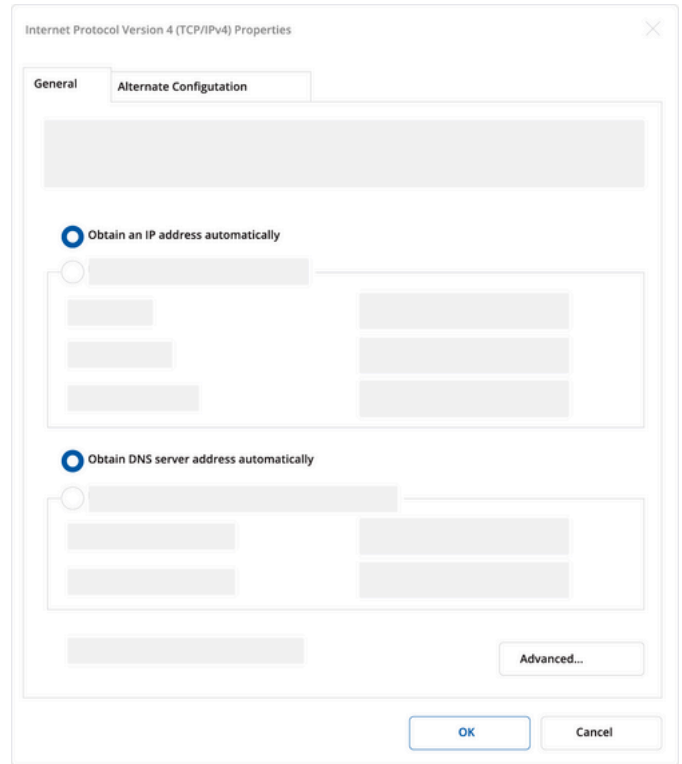

## Mounting instruction

### Wall Mounting

1. The tools and fasteners required for installing the OTD144 depend on the type of wall surface and the chosen fasteners. To secure the OTD144's housing onto the bracket, you will need a screwdriver, ideally one with a PZ2 nozzle.



2. Remove the bottom part of the OTD144's and remove the bracket by unscrewing the screws.



3. The bracket should be attached to the wall using screws fitting for the type of wall surface. The diameter of the holes should be 4.8 mm, or about 0.19 inches.

4. Align the OTD144 with the bracket and press it downward until the OTD144's housing is locked into place on the bracket. This locking should close a gap of about 10 mm, or 0.39 inches.



5. Insert and tighten the screw provided in the kit to secure the locked housing to the bracket.



6. Finally, attach the bottom part of the OTD144's housing to the bottom of the mounted router.



### Pole Mounting

1. It is recommended to install the OTD on a pole at least 45 mm, or about 1.77 inches, in diameter. Ensure the chosen pole can support the weight of the product, which is 855 g. and you will need a screwdriver, ideally one with a PZ2 nozzle.



3. Select any of the bracket's holes to fit the width of the fastener, either a plastic zipper or a metal lintel. For plastic zippers, the diameter of the holes should be 4.8 mm, or about 0.31 inches. For metal lintel, it should be 8 mm, or about 0.31 inches. Note that product kit does not include any fasteners.

2. Remove the bottom part of the OTD144's and remove the bracket by unscrewing the screws.

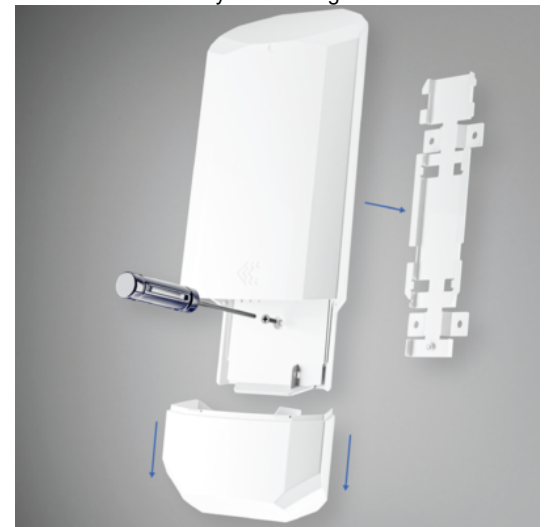

4. Align the OTD144 with the bracket and press it downward until the OTD144's housing is locked into place on the bracket. This locking should close a gap of about 10 mm, or 0.39 inches.

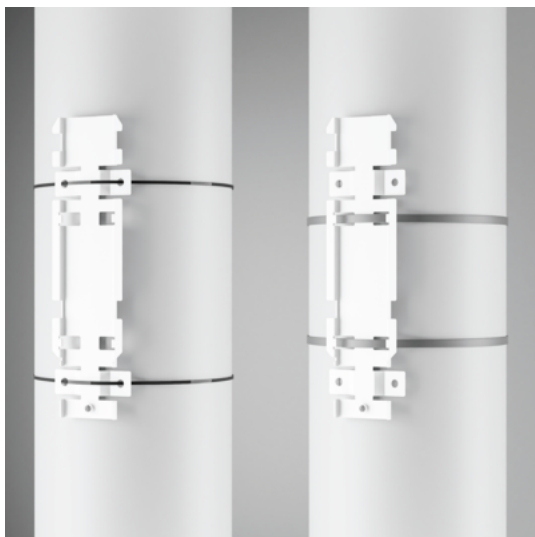

5. Insert and tighten the screw provided in the kit to secure the locked housing to the bracket.

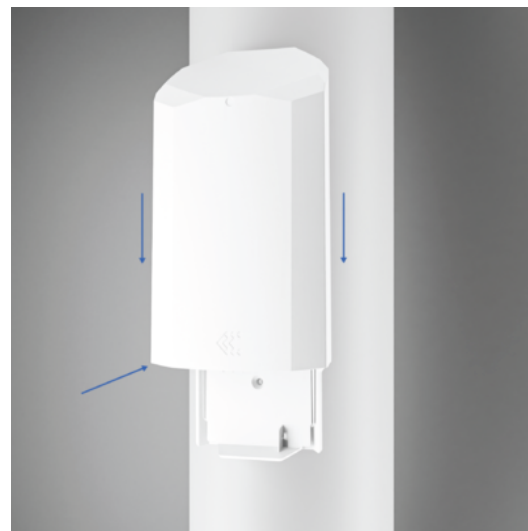

6. Finally, attach the bottom part of the OTD144's housing to the bottom of the mounted router.



## Login to device

1. To enter the router's Web interface (WebUI), type <http://192.168.1.1> into the URL field of your Internet browser.

2. When prompted for authentication enter the username admin and enter the password located on the device information label/engraving.

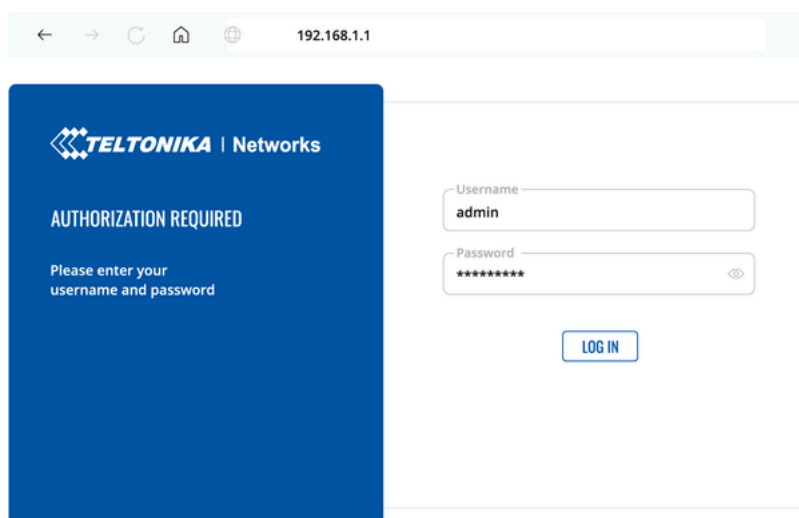

3. After logging in, you must set a new password for security reasons. You will not be able to interact with the router's WebUI until the default password is changed. The new password must consist of a minimum of **8 characters**. Requirements: one uppercase letter, one lowercase letter, and one

digit.

4. Next, the Configuration Wizard will start to help you set up some of the router's main operational parameters.

---

Retrieved from "[https://wiki.teltonika-networks.com/index.php?title=QSG\\_OTD144&oldid=157684](https://wiki.teltonika-networks.com/index.php?title=QSG_OTD144&oldid=157684)"

-