

# QSG RUT241

[Main Page](#) > [RUT Routers](#) > [RUT241](#) > **QSG RUT241**



This Wiki page contains the online version of the **Quick Start Guide (QSG)** for the **RUT241 LTE Router**. Here you will find an overview of the various components on the front and back of a RUT241 device, hardware installation instructions, first login information, device specifications, and general safety information. It is highly recommended to acquaint yourself with the Quick Start Guide before using the device. You can also locate a printed version of the Quick Start Guide in the packaging box of your device.



## Safety information

Before starting operating the device, please review recommendations and precautions to minimize the possibility of accidents. Safety precautions presented are supplementary and subject to the local safety regulations. When various operations are executed on the device, the user must fully follow the safety instructions and recommendations provided with the device.

## General

Radio specifications	
RF technologies	2G, 3G, 4G, WiFi
Max RF power	33 dBm@GSM, 24 dBm@WCDMA, 23 dBm@LTE, 20 dBm@WiFi
Bundled accessories specifications*	
Power adapter	Input: 0.45A@100-240 VAC, Output: 9 VDC, 1A, 4-pin plug
Mobile antenna	698~960/1710~2690 MHz, 50 Ω, VSWR<3, gain** 4 dBi, omnidirectional, SMA male connector
WiFi antenna	2400~2500 MHz, 50Ω, VSWR<2.5, gain** 5dBi, omnidirectional, RP-SMA male connector

\* Order code dependant.

\*\* Higher gain antenna can be connected to compensate for cable attenuation when a cable is used. The user is responsible for the compliance with the legal regulations.

RUT241 router must be used in compliance with any and all applicable national and international laws and with any special restrictions regulating the utilization of the communication module in prescribed applications and environments.

## **CE Declaration of Conformity**

<b>[BG] Bulgarian</b>	С настоящето, TELTONIKA NETWORKS декларира, че RUT241 е в съответствие със съществените изисквания и другите приложими разпоредби на Директива 2014/53/EU
<b>[HR] Croatian</b>	Ovim TELTONIKA NETWORKS izjavljuje da je ovaj RUT241 u skladu s bitnim zahtjevima i ostalim relevantnim odredbama Direktive 2014/53/EU
<b>[CZ] Czech</b>	TELTONIKA NETWORKS tímto prohlašuje, že RUT241 splňuje základní požadavky a všechna příslušná ustanovení Směrnice 2014/53/EU
<b>[DK] Danish</b>	Undertegnede TELTONIKA NETWORKS erklærer herved, at følgende udstyr RUT241 overholder de væsentlige krav og øvrige relevante krav i direktiv 2014/53/EU
<b>[NL] Dutch</b>	Hierbij verklaart TELTONIKA NETWORKS dat het toestel I RUT241 in overeenstemming is met de essentiële eisen en de andere relevante bepalingen van richtlijn 2014/53/EU
<b>[EE] Estonian</b>	Käesolevaga kinnitab TELTONIKA NETWORKS seadme RUT241 vastavust direktiivi 2014/53/EU põhinõuetele ja nimetatud direktiivist tulenevatele teistele asjakohastele sätetele
<b>[FI] Finish</b>	TELTONIKA NETWORKS vakuuttaa täten että RUT241 tyyppinen laite on direktiivin 2014/53/EU oleellisten vaatimusten ja sitä koskevien direktiivin muiden ehtojen mukainen
<b>[FR] French</b>	TELTONIKA NETWORKS déclare que cette RUT241 est conforme aux exigences essentielles et aux autres dispositions pertinentes de la directive 2014/53/EU
<b>[DE] German</b>	Hiermit erklärt TELTONIKA NETWORKS, dass dieser RUT241 den grundlegenden Anforderungen und anderen relevanten Bestimmungen der Richtlinie 2014/53/EU entspricht
<b>[GR] Greek</b>	ΜΕ ΤΗΝ ΠΑΡΟΥΣΑ Ο ΚΑΤΑΣΚΕΥΑΣΤΗΣ TELTONIKA NETWORKS ΔΗΛΩΝΕΙ ΟΤΙ RUT241 ΣΥΜΜΟΡΦΩΝΕΤΑΙ ΠΡΟΣ ΤΙΣ ΟΥΣΙΩΔΕΙΣ ΑΠΑΙΤΗΣΕΙΣ ΚΑΙ ΤΙΣ ΛΟΙΠΕΣ ΣΧΕΤΙΚΕΣ ΔΙΑΤΑΞΕΙΣ ΤΗΣ ΟΔΗΓΙΑΣ 2014/53/EU
<b>[HU] Hungarian</b>	A TELTONIKA NETWORKS ezzennel kijelenti, hogy a RUT241 típusú berendezés teljesíti az alapvető követelményeket és más 2014/53/EU irányelvben meghatározott vonatkozó rendelkezéseket
<b>[IE] Irish</b>	Leis seo, dearbhaíonn TELTONIKA NETWORKS go gcomhlíonann an RUT241 seo bunriachtanais agus forálacha ábhartha eile Threoir 2014/53/EU
<b>[IT] Italian</b>	Con la presente, TELTONIKA NETWORKS dichiara che questo RUT241 è conforme ai requisiti essenziali e ad altre disposizioni pertinenti della Direttiva 2014/53/EU
<b>[LV] Latvian</b>	Ar šo TELTONIKA NETWORKS deklarē, ka RUT241 atbilst Direktīvas 2014/53/EU būtiskajām prasībām un citiem ar to saistītajiem noteikumiem
<b>[LT] Lithuanian</b>	Šiuo dokumentu UAB TELTONIKA NETWORKS deklaruoja, kad šis RUT241 atitinka esminius reikalavimus ir kitas 2014/53/EU Direktyvos nuostatas
<b>[MT] Maltese</b>	Hawnhekk, TELTONIKA NETWORKS tiddikjara li dan I-RUT241 huwa konformi mar-rekwiżiti essenzjali u dispożizzjonijiet rilevanti oħra tad Direttiva 2014/53/EU
<b>[NO] Norwegian</b>	TELTONIKA NETWORKS Erklærer herved at RUT241 er i samsvar med de grunnleggende krav og øvrige relevante krav i direktiv 2014/53/EU
<b>[PL] Polish</b>	Niniejszym TELTONIKA NETWORKS deklaruje że RUT241 jest zgodny z zasadniczymi wymaganiami i innymi właściwymi postanowieniami Dyrektywy 2014/53/EU
<b>[PT] Portuguese</b>	Eu, TELTONIKA NETWORKS declaro que o RUT241 cumpre os requisitos essenciais e outras provisões relevantes da Directiva 2014/53/EU
<b>[RO] Romanian</b>	Prin prezenta, TELTONIKA NETWORKS declară că aparatul RUT241 este în conformitate cu cerințele esențiale și cu alte prevederi pertinente ale Directivei 2014/53/EU
<b>[SK] Slovak</b>	Spoločnosť TELTONIKA NETWORKS týmto vyhlasuje, že smerovač RUT241 je v súlade so základnými požiadavkami a ďalšími príslušnými ustanoveniami smernice 2014/53/EU
<b>[SI] Slovenian</b>	TELTONIKA NETWORKS izjavlja, da je ta RUT241 v skladu z bistvenimi zahtevami in drugimi relevantnimi določili direktive 2014/53/EU
<b>[ES] Spanish</b>	Por la presente, TELTONIKA NETWORKS declara que este RUT241 cumple con los requisitos esenciales y otras exigencias relevantes de la Directiva 2014/53/EU
<b>[SE] Swedish</b>	Härmed intygar TELTONIKA NETWORKS att denna RUT241 är i överensstämmelse med de väsentliga egenskapskrav och övriga relevanta bestämmelser som framgår av direktiv 2014/53/EU

## FCC

This device complies with Part 15 of the FCC Rules. Operation is subject to the following two conditions:

1. This device may not cause harmful interference.
2. This device must accept any interference received, including interference that may cause undesired operation.

This equipment has been tested and found to comply with the limits for a Class B digital device, pursuant to Part 15 of the FCC Rules. These limits are designed to provide reasonable protection against harmful interference in a residential installation. This equipment generates, uses and can radiate radio frequency energy and if not installed and used in accordance with the instructions, may cause harmful interference to radio communications. However, there is no guarantee that interference will not occur in a particular installation. If this equipment does cause harmful interference to radio or television reception, which can be determined by turning the equipment off and on, the user is encouraged to try to correct the interference by one or more of the following measures:

- Reorient or relocate the receiving antenna.
- Increase the separation between the equipment and receiver.
- Connect the equipment into an outlet on a circuit different from that to which the receiver is connected.
- Consult the dealer or an experienced radio/TV technician for help.

**FCC Caution:** Changes or modifications not expressly approved by the party responsible for compliance could void the user's authority to operate the equipment.

## ISED Canada

This device contains license-exempt transmitter(s)/receiver(s) that comply with Innovation, Science, and Economic Development Canada's license-exempt RSS(s). Operation is subject to the following two conditions:

1. This device may not cause interference;
2. This device must accept any interference, including interference that may cause undesired operation of the device.

L'émetteur/récepteur exempt de licence contenu dans le présent appareil est conforme aux CNR d'Innovation, Sciences et Développement économique Canada applicables aux appareils radio exempts de licence. L'exploitation est autorisée aux deux conditions suivantes:

1. L'appareil ne doit pas produire de brouillage;
2. L'appareil doit accepter tout brouillage radioélectrique subi, même si le brouillage est.

Detailed compliance information is available at the following internet address: [wiki.teltonika-networks.com/view/Certificates](https://wiki.teltonika-networks.com/view/Certificates) (<https://wiki.teltonika-networks.com/view/Certificates>).



This sign means that it is necessary to read the User's Manual before you start using the device.



This sign on the package means that all used electronic and electric equipment should not be mixed with general household waste.



Hereby, TELTONIKA NETWORKS declares that this RUT241 is in compliance with the essential requirements and other relevant provisions of Directive 2014/53/EU. The full text of the EU declaration of conformity is available at the following internet address: [https://wiki.teltonika-networks.com/view/RUT241\\_CE/RED](https://wiki.teltonika-networks.com/view/RUT241_CE/RED)



Hereby, TELTONIKA NETWORKS declares that the radio equipment type RUT241 is in compliance with Radio Equipment Regulations 2017. The full text of the UK declaration of conformity is available at the following internet address: [https://wiki.teltonika-networks.com/view/RUT241\\_UKCA](https://wiki.teltonika-networks.com/view/RUT241_UKCA)

## RF exposure

This device meets the official requirements for exposure to radio waves. This device is designed and manufactured not to exceed the emission limits for exposure to radio frequency (RF) energy set by authorized agencies. The device must be used with a minimum separation of 20 cm from a person's body to ensure compliance with RF exposure guidelines. Failure to observe these instructions could result in your RF exposure exceeding the applicable limits.

External antennas used with RUT241 must be installed to provide a distance of at least 20 cm from any people and must not be co-located or operated in conjunction with any other antenna or transmitter.

Any external antenna gain must meet RF exposure and maximum radiated output power limits of the applicable rule section.

Maximum transmission power	
GSM	33 dBm
WCDMA	24 dBm
LTE	23 dBm
WiFi	20 dBm

### FCC Radiation Exposure Statement:

This device complies with the relevant FCC RF radiation exposure limit set forth for an uncontrolled environment. The antenna(s) used for this transmitter must not be co-located or operating in conjunction with any other antenna or transmitter and must be installed to provide a separation distance of at least 20 cm from all persons.

### ISED Canada Radiation Exposure Statement:

This equipment complies with IC RSS-102 radiation exposure limits set forth for an uncontrolled environment. This equipment should be installed and operated with minimum distance 20 cm between the radiator and your body.

Cet équipement est conforme aux limites d'exposition aux radiations IC CNR-102 établies pour un environnement non contrôlé. Cet équipement doit être installé et utilisé avec une distance minimale de 20 cm entre le radiateur et votre corps.

## Operating conditions

---

- Operating temperature: -40° to +75° Celsius
- Humidity should be in the range of 10% to 90% (non-condensing). Only use the device in dry environments.
- Out of direct sunlight
- Away from heat source, corrosive substances, salts, and flammable gases

**Attention:** operation outside the permissible range can considerably shorten the service life of the device.

## Faulty and damaged products

---

- Do not attempt to disassemble the device or its accessories.
- Only qualified personnel must service or repair the device or its accessories.
- If your device or its accessories have been submerged in water punctured or subjected to a severe fall, do not use until they have been checked at an authorized service center.

## Electrical safety

---

- Only use approved accessories.
- Do not connect with incompatible products or accessories.
- It is recommended to ground devices with grounding terminals before connecting them to power. Failure to ground appropriately might result in a shock hazard. The cross-sectional area of the protective grounding conductor should be at least 1mm<sup>2</sup>.

## Product handling

---

- You alone are responsible for how you use your device and any consequences related to its use.
- Use of your device is subject to safety measures designed to protect users and their environment.
- Always treat your device and its accessories with care and keep it in a clean and dust-free place.
- Do not expose your device or its accessories to open flames, lit tobacco products, liquid, moisture, or high humidity.
- Do not drop, throw or try to bend your device or its accessories.
- Do not use harsh chemicals, cleaning solvents, or aerosols to clean the device or its accessories.
- Do not paint your device or its accessories.
- Do not attempt to disassemble your device (exemptions for devices that require disassembly for SIM insertion) or its accessories: it does not contain any user-serviceable parts. For safety reasons, the equipment should be opened only by qualified personnel.
- Make sure to use ESD personal protective equipment while the equipment is serviced.

- Do not use your device in an enclosed environment where heat dissipation is poor.
- Prolonged use in such space may cause excessive heat and raise ambient temperature, which will lead to the automatic shutdown of your device or the disconnection of the mobile network connection for your safety. To use your device again after such a shutdown, cool it in a well-ventilated place before turning it on.
- Please check all national laws and local regulations for the disposal of electronic products.
- Do not operate the device where ventilation is restricted.
- Do not use or install this product near water to avoid fire or shock hazards.
- Avoid exposing the equipment to rain or damp areas.
- Arrange power and Ethernet cables so that they are not likely to be stepped on or have items placed on them.
- Ensure that the voltage and the rated current of the power source match the device's requirements. Do not connect the device to an inappropriate power source.
- During a thunderstorm, no operations should be carried out on the device and cables.
- The unit must be powered off where blasting is in progress and explosive atmospheres are present or near medical life support equipment.
- Do not leave your device and its accessories within reach of small children or allow them to play with it. They could hurt themselves or others and could accidentally damage the device. Your device contains small parts with sharp edges that may cause an injury choking hazard.
- Like any wireless device, this device operates using radio signals, which cannot guarantee connection in all conditions. Therefore, you must never rely solely on any wireless device for emergency communications or otherwise use the device in situations where the interruption of data connectivity could lead to death, personal injury, property damage, data, or other loss.
- The device may become warm during regular use.

## Front view

---

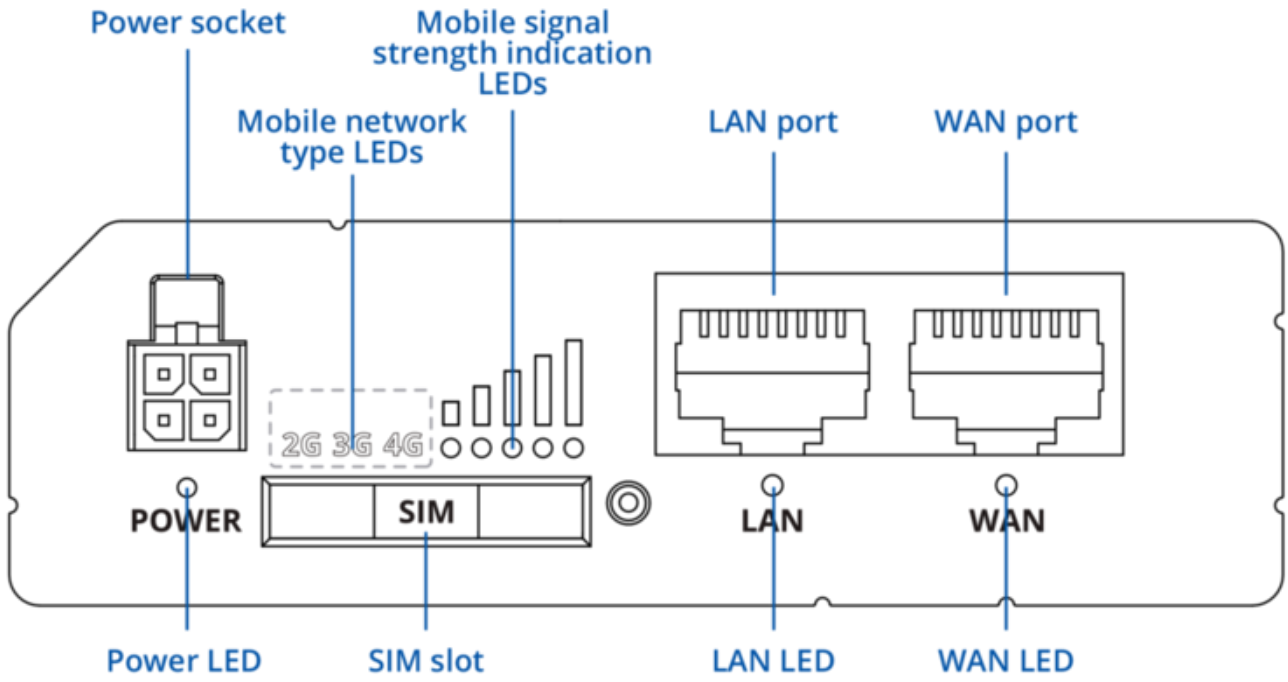

## Back view

---

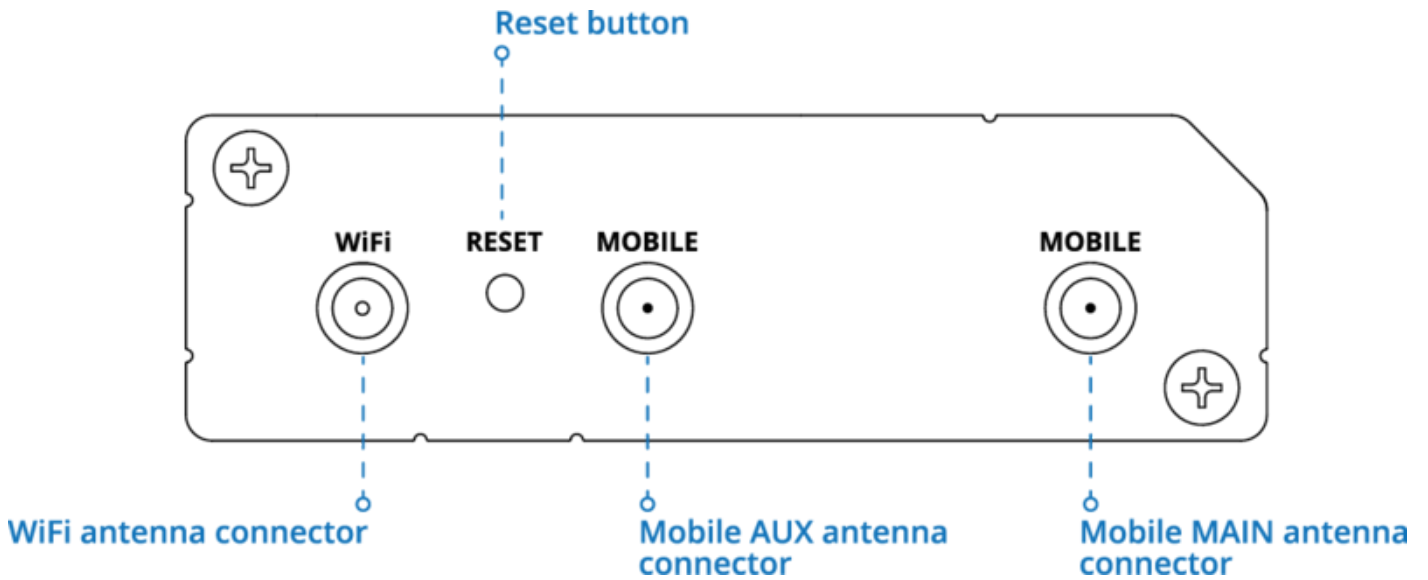

## Connectors

---

### POWER SOCKET PINOUT

NO.	DESCRIPTION	WIRE COLOR
1	Power	Red
2	Ground	Black
3	I/O	Green
4	I/O	White

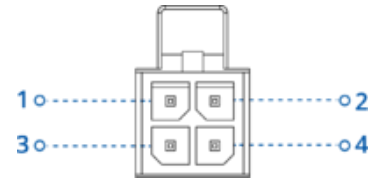

## Video Quick Start Guide

Need some help setting up your new Teltonika Networks RUT241 Industrial Cellular Router? Watch our quick start guide video and follow the step by step instructions to easily set up your new router for operation.

RUT241 Industrial Cellular Router Quick Start Guide | Telton...



## eSIM

The Mobile eSIM feature on RUT241 eSIM devices allows users to manage eSIM profiles, configure settings, and use enhanced network capabilities. For more information please refer to the [RUT241 eSIM manual](#).

**Note** that eSIM functionality is only supported on [RUT241 eSIM \(https://teltonika-networks.com/products/routers/RUT241-esim\)](https://teltonika-networks.com/products/routers/RUT241-esim) devices. Refer to the [RUT241 eSIM product page \(https://teltonika-networks.com/products/routers/RUT241-esim\)](https://teltonika-networks.com/products/routers/RUT241-esim).

- **eSIM Profiles** - You can easily add new eSIM profiles or configure existing ones. This section details profile management, including editing profile names and activation codes.
- **SIM Switch** - The SIM Switch provides you with the possibility to configure SIM switching rules, i.e., set up circumstances under which the device will perform a switch from using one SIM card to another.
- **Multiwan** - The Failover function allows you to backup your primary WAN connection in case it goes down.

## ^ eSIM profiles

1   Demo	State: Enabled	Provider: Global1 ICCID: 8988308650100308054F	<a href="#">Edit</a> <a href="#">Delete</a>
----------	----------------	--	---

To learn more about all the eSIM feature and its settings, please refer to the [RUT241 eSIM manual](#).

## Hardware installation

### 1. Locate the SIM Adapter kit

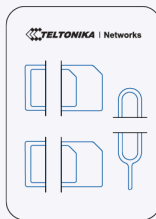

### 2. Push the SIM holder button with the SIM needle.

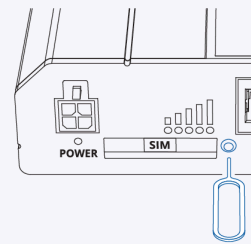

### 2. Pull out the SIM holder.

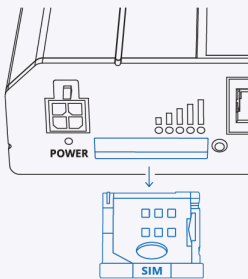

### 3. Insert your SIM card into the SIM holder.

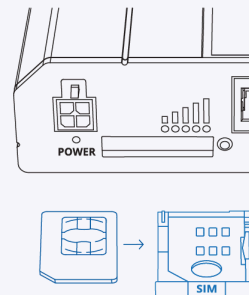

### 4. Slide the SIM holder back into the router.

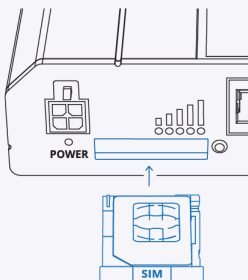

### 5. Attach both MAIN and AUX mobile antennas to connectors labeled "Mobile".

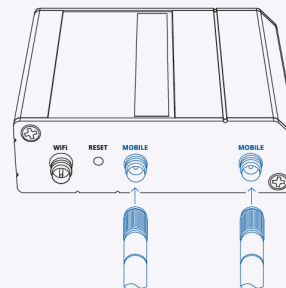

6. Attach WiFi antenna to the connector labeled "WiFi".

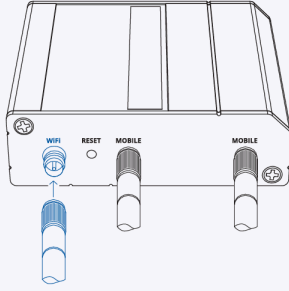

7. Connect the 4-pin connector to the power socket on the front of the device. then plug the power adapter into an electric outlet.

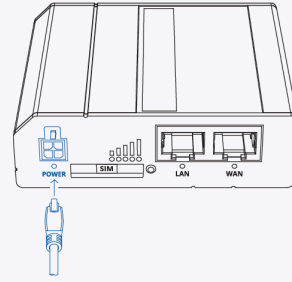

## Configure your computer LAN (Windows)

1. Ensure the Network connection is Enabled. Go to Start — Control Panel — Network and Internet — Network and Sharing Center. Click on the **Change adapter settings** in the left panel, then right-click on Network Adapter, and select Enable.

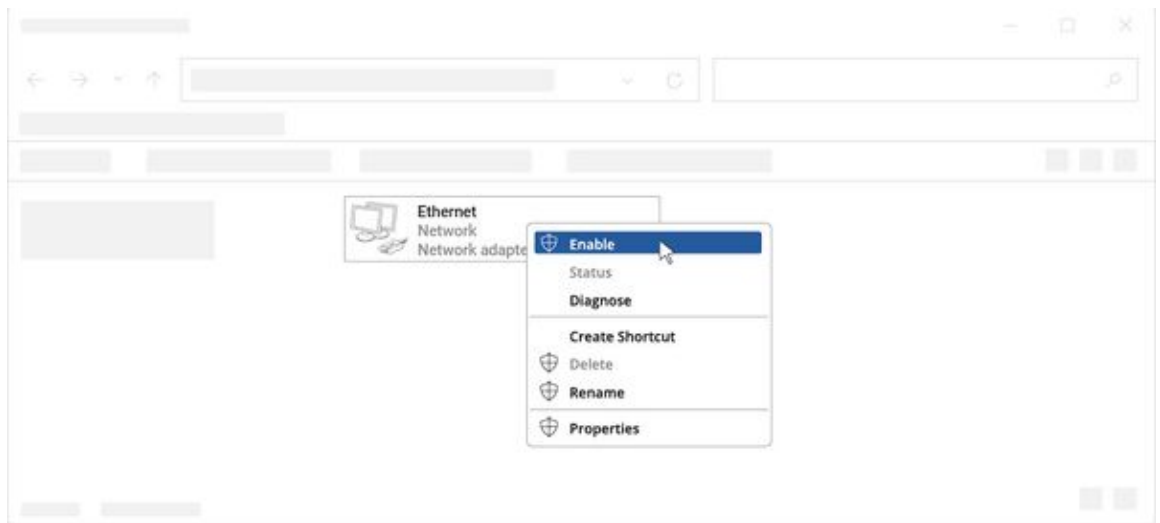

2. Check if IP and DNS are obtained automatically. Right-click on Network Adapter and select Properties. Then select **Internet Protocol Version 4** and click Properties.  
3. If not selected,

check to **obtain an IP address** and **obtain DNS server address automatically**. Click OK.



## Configure your computer Wi-Fi (Windows)

1. Ensure the Wireless network connection is Enabled. Go to Start — Control Panel — Network and Internet — Network and Sharing Center. Click on the **Change adapter settings** in the

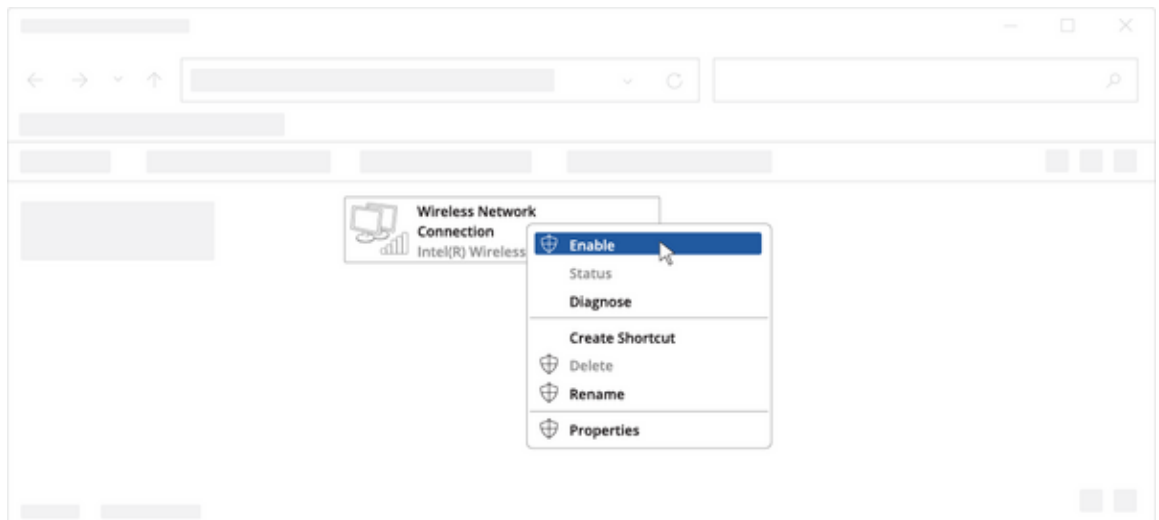

left panel, then right-click on Wireless Network Adapter, and select Enable.

2. Check if IP and DNS are obtained automatically. Right-click on Wireless Network Adapter and select Properties. Then select **Internet Protocol Version 4** and click Properties.  
3. If not selected, check to **obtain an IP address** and **obtain DNS server address automatically**. Click OK.



4. Connect to a wireless network by right-clicking on Wireless Network Adapter and selecting Connect.

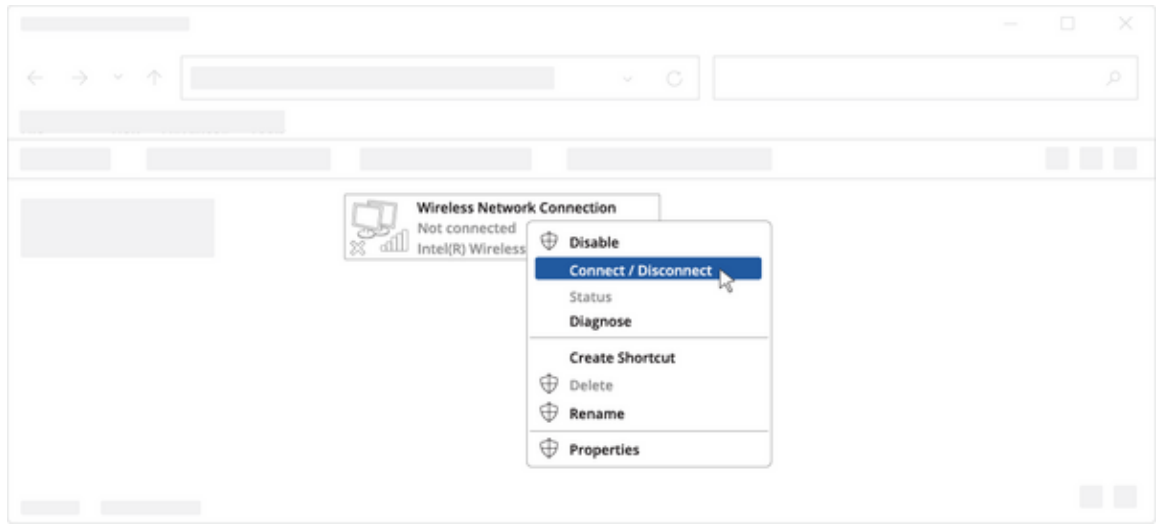

5. Choose the wireless network RUT241 \*\*\*\* from the list and click Connect. Enter the Wi-Fi password located on the device's label.

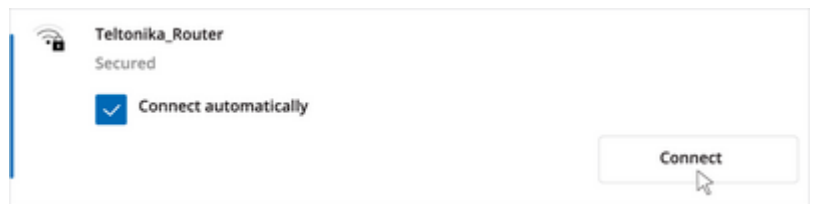

## Login to device

1. To enter the router's Web interface (WebUI), type <http://192.168.1.1> into the URL field of your Internet browser.

2. When prompted for authentication enter the username admin and enter the password located on the device information label/engraving.

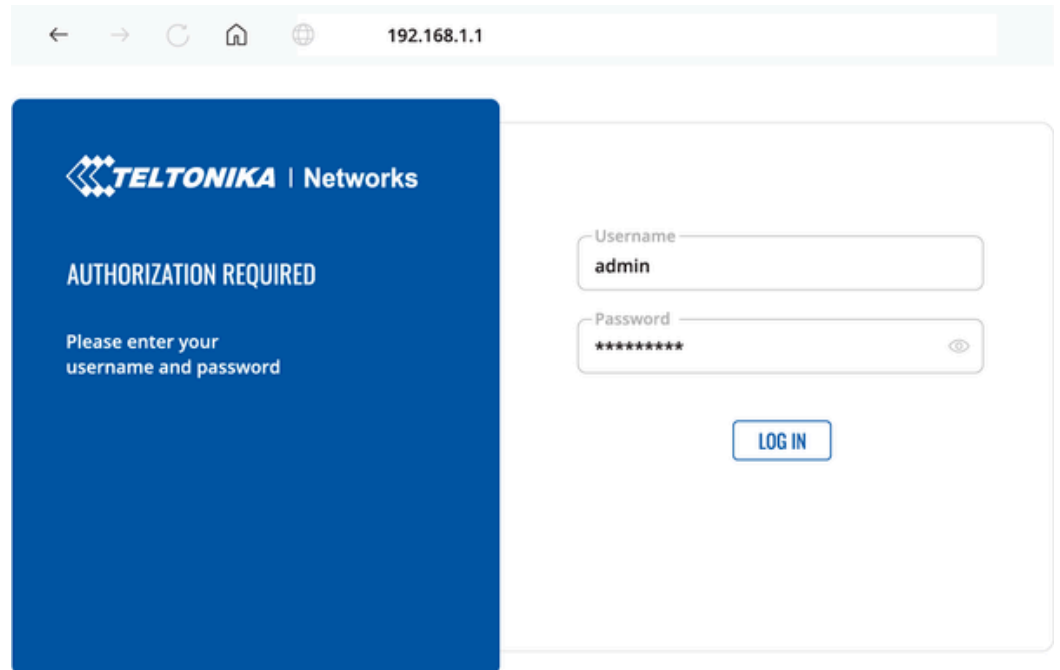

3. After logging in, you must set a new password for security reasons. You will not be able to interact with the router's WebUI until the default password is changed. The new password must consist of a minimum of **8 characters**. Requirements: one uppercase letter, one lowercase letter, and one digit.

4. Next, the Configuration Wizard will start to help you set up some of the router's main operational parameters.

5. Finally, let's verify the Mobile signal strength. Go to the **Status — Network** page and pay attention to the **Signal Strength** indication.

To achieve the best signal conditions and maximize cellular performance, try adjusting the antennas or changing the location of your device. You can find information on signal strength recommendations [here](#).

**MODEM** ⓘ 📶 -44 dBm

---

**DATA CONNECTION**  
Connected

---

**STATE**  
registered (home); LTE; 4G+ (LTE-A)

---

**SIM CARD INFO**  
SIM 1 Ready

---

**BYTES RECEIVED / SENT**  
42.6 MB / 2.5 MB

## SIM card recommendations

- Before installing the SIM cards, please apply a thin layer of dielectric grease to the SIM card contacts for devices used in environments with **high-vibration levels**. This will help avoid SIM cards losing touch with the SIM slot and prevent unexpected failures.
- Industrial Grade SIM cards are recommended for devices requiring a long lifespan used in environments with **extreme temperatures, corrosive** or **extra humid climates**, or hard-to-

reach locations.

---

Retrieved from "[https://wiki.teltonika-networks.com/index.php?title=QSG\\_RUT241&oldid=138568](https://wiki.teltonika-networks.com/index.php?title=QSG_RUT241&oldid=138568)"

-