

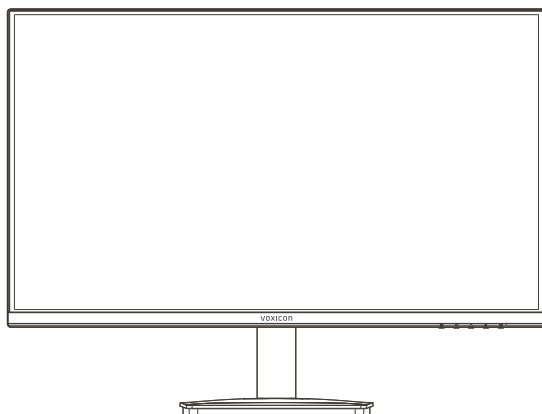

User Manual

D27FT8U



CONTENT

▶ PREPARATION	2-4
Unpacking and Installation.....	2
Standard Accessories	2
Monitor View	2
Stand Installation	3
Adjust the Monitor	4
▶ CONTROL BUTTON	4
▶ POSITIONING THE MONITOR	5
▶ SPECIFICATION	5
▶ TERMINAL CONNECTION	6
▶ WARNING AND PRECAUTION	7-9
Important Safety Instructions.....	7
WEEE Directive	8
Trouble Shooting	8
Mounting on a Wall	9
▶ SERVICE, WARRANTY AND PIXEL POLICY	9



1. The pictures in this manual are only for reference.
2. Design and specifications are subject to change without notice.
3. In dry environment due to static electricity, the product may restart and return to the main OSD interface or the previous source mode. It is normal and please continue to operate the monitor as you will.

PREPARATION

► Unpacking and Installation



1

Open the package.

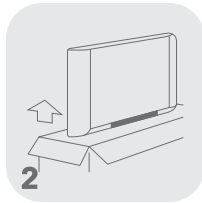

2

Take out the monitor.

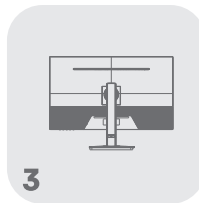

3

Install the stand.

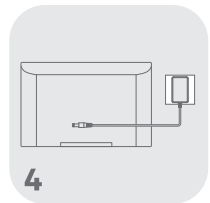

4

Connect the power adapter.

► Standard Accessories

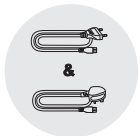

Power Cord

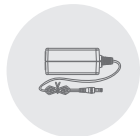

Power Adapter



User Manual



Base



Supporting Column



HDMI Cable



USB-B To USB-A
Cable

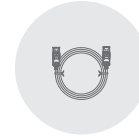

DP Cable

► Monitor View

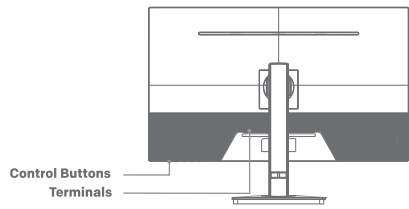

► Stand Installation

Step 1: Take out monitor with polyton , remove the upper polyton, and then carefully put the monitor (screen downward) on a stable and flat table with a soft cloth or the bottom polyton.

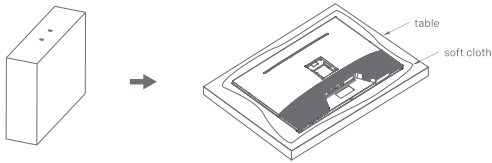

Step 2: Vertically insert the base top into the bottom end of the supporting column, then assemble them by fastening the thumb screw with your fingers.

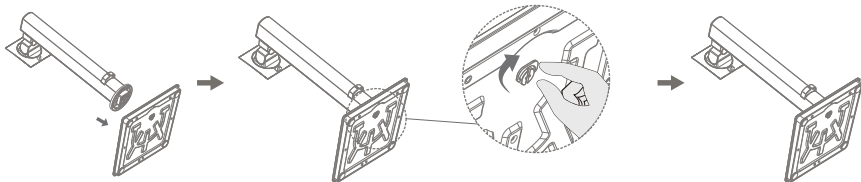

Step 3: Align and insert the upper tabs on the hinge of the stand into the slot on the monitor back. Then press the lower part of the hinge down towards the monitor back until the lower tabs are fully locked in position.

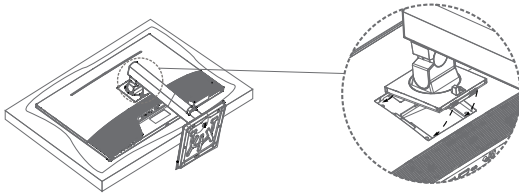

Step 4: Connect the signal cable and power cord. In addition, easily remove the stand (assembled base and supporting column) by pushing the button in the direction of the arrow.

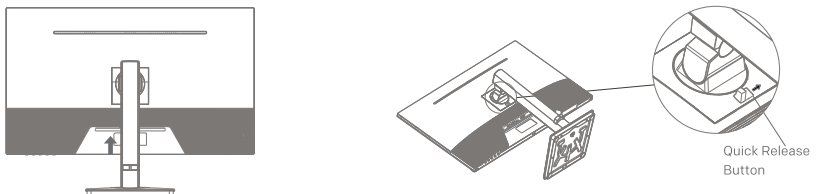

• Stand and installation methods may vary depending on the model.

► Adjust the Monitor



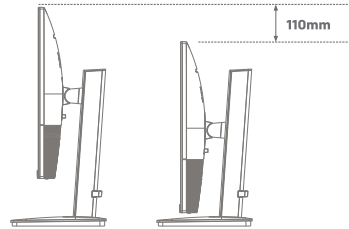
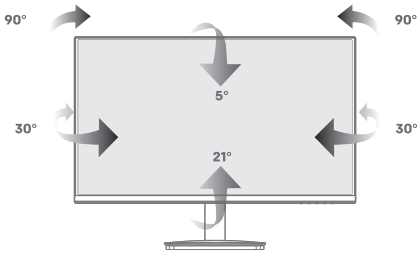



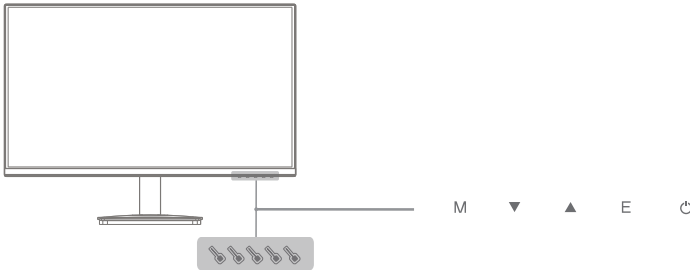

The direction of monitor can be adjusted (tilted by -5° ~ 21° , swiveled by -30° ~ 30° and pivoted by -90° ~ 90°).
The height of monitor can be adjusted by 0 ~ 110 mm.



- 1. While adjusting the monitor, please avoid using excessive force and hitting other parts or objects to prevent damage.
- 2. To prevent the monitor from hitting the stand or other objects, please make sure you have adjusted the monitor to the highest position before pivoting the monitor.

CONTROL BUTTON



- **Press **:
In power-off mode, press  button to turn on the monitor.
In working status, long press  button to turn the monitor to power-off mode.
- **M /  /  / E**
When the main menu is displayed on the screen, press M /  /  / E button to execute the following functions.
 - * Press  /  button to move the cursor down/up to select the desired submenu or item, or adjust the value of selected item.
 - * Press M button to access the selected submenu or item.
 - * Press E button to return back to the upper-level menu, or exit the main menu.

 The icons, positions and functions of monitor control buttons may vary depending on the region and model.

► Positioning the Monitor

- Install the monitor on solid horizontal surface such as a table or desk. For ventilation, leave a space of at least 10cm free all around the set. To prevent any fault and unsafe situations, please do not place any objects on top of the set. This apparatus can be used in tropical and/or moderate climates.
- Fix the rear of enclosure to wall (only for some countries) .

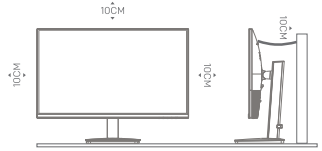

● Warning: Stability Hazard

A monitor set may fall, causing serious personal injury or death. Many injuries, particularly to children, can be avoided by taking simple precautions such as:

- ALWAYS use cabinets or stands or mounting methods recommended by the manufacturer of the monitor set.
- ALWAYS use furniture that can safely support the monitor set.
- ALWAYS ensure the monitor set is not overhanging the edge of the supporting furniture.
- ALWAYS educate children about the dangers of climbing on furniture to reach the monitor set or its controls.
- ALWAYS route cords and cables connected to your monitor so they cannot be tripped over, pulled or grabbed.
- NEVER place a monitor set in an unstable location.
- NEVER place the monitor set on tall furniture (for example, cupboards or bookcases) without anchoring both the furniture and the monitor set to a suitable support.
- NEVER place the monitor set on cloth or other materials that may be located between the monitor set and supporting furniture.
- NEVER place items that might tempt children to climb, such as toys, on the top of the monitor or furniture on which the monitor is placed.

If the existing monitor set is being retained and relocated, the same considerations as above should be applied.

SPECIFICATION

Model	D27FT9U
Input	12 V $\overline{\text{---}}$ 4.0 A
Contrast (Typical)	1300:1 (Typ.)
Brightness	250 nits (Typ.)
Resolution (H X V)	2560 x 1440
Aspect Ratio	16:9
Refresh Rate	100 Hz (Max)
G To G	14 ms
Viewing Angle (H/V)	178° / 178°
Diagonal Length of Active Display Area	68.5 cm
Dimensions without stand (W X H X D)	614 X 363 X 52 mm
Dimensions with stand (W X H X D)	614 X 464 X 203 mm
Environment	Working temperature: 5°C~40°C Working humidity: 20%~80% Storage temperature: -15°C~45°C Storage humidity: 10%~90%, non-condensing

☀ Specifications may vary depending on the region or model.

TERMINAL CONNECTION

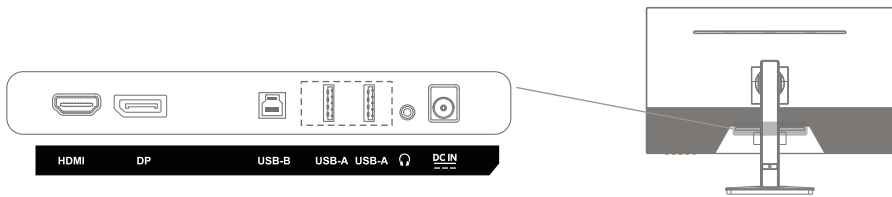

• HDMI

Connect a computer via an HDMI cable.

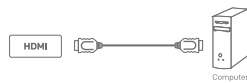

• DP

Connect a computer via an DP cable.

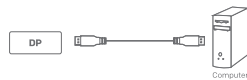

• USB-B (3.0)

Connect a computer via an USB-B to USB-A cable.



• USB-A (3.0)

Connect the wired USB-A devices.

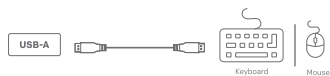

•

Output the monitor's audio signal to the connected headphone.



• DC IN

Connect the power adapter (12V  4A).



1. Terminal quantities and names may vary depending on the region or model.

2. External equipments and cables shown herein are not supplied with the monitor.

3. Power adapter supplied with the monitor may vary depending on the region or model.

4. To avoid electric shock, please make sure you have disconnected the power cord before connecting external cables and devices.

WARNING AND PRECAUTION

► Important Safety Instructions

- Read these instructions – All the safety and operating instructions should be read before this product is operated.
- Keep these instructions – The safety and operating instructions should be retained for future reference.
- Heed all warnings – All warnings on the appliance and in the operating instructions should be adhered to.
- Follow all instructions – All operating and use instructions should be followed.
- Do not use this apparatus near water – The appliance should not be used near water or moisture – for example, in a wet basement or near a swimming pool, and the like.
- Clean only with dry cloth.
- Do not block any ventilation openings. Install in accordance with the manufacturer's instructions.
- Do not install near any heat sources such as direct sunlight, radiators, heat registers, stoves, or other apparatus (including amplifiers) that produce heat.
- Do not defeat the safety purpose of the polarized or grounding plug. A polarized plug has two blades with one wider than the other. A grounding plug has two blades and a third grounding prong. The wide blade or the third prong is provided for your safety. If the provided plug does not fit into your outlet, consult an electrician for replacement of the obsolete outlet.
- Protect the power cord from being walked on or pinched particularly at the plugs, convenience receptacles, and at the point where they exit from the apparatus.
- Only use attachments/accessories specified by the manufacturer.
-  Use only with the cart, stand, tripod, bracket, or table specified by the manufacturer, or sold with the apparatus. When a cart or rack is used, use caution when moving the cart/apparatus combination to avoid injury from tip-over.
- Unplug the apparatus during lightning storms or when unused for long periods of time.
- Refer all servicing to qualified personnel. Servicing is required when the apparatus has been damaged in any way, such as power supply cord or plug is damaged, liquid has been spilled or objects have fallen into the apparatus, the apparatus has been exposed to rain or moisture, does not operate normally, or has been dropped.
- CAUTION: These servicing instructions are for use by qualified service personnel only. To reduce the risk of electric shock, do not perform any servicing other than that contained in the operating instructions unless you are qualified to do so.
- Do not install this equipment in a confined or building-in space such as a book case or similar unit, and remain a well ventilation conditions at open site. The ventilation should not be impeded by covering the ventilation openings with items such as newspaper, table-cloths, curtains etc.
- Please refer the information on rear enclosure for electrical and safety information before installing or operating the apparatus.
- To reduce the risk of fire or electric shock, do not expose this apparatus to rain or moisture.
- The apparatus shall not be exposed to dripping or splashing and that no objects filled with liquids, such as vases, shall be placed on the apparatus. Do not use the set near dust place.
- For the terminals marked with symbol of “⚡” may be of sufficient magnitude to constitute a risk of electric shock. The external wiring connected to the terminals requires installation by an instructed person or the use of ready-made leads or cords.
- To prevent injury, use the stand/wall-mount bracket to securely install this apparatus on the table/wall in accordance with the installation instructions.
- Danger of explosion if battery is incorrectly replaced. Replace only with the same or equivalent type.
- Danger of explosion if battery is incorrectly replaced. Replace only with the same or equivalent type. The battery (battery or batteries or battery pack) shall not be exposed to excessive heat such as sunshine, fire or the like.
- Excessive sound pressure from earphones and headphones can cause hearing loss. Listening to music at high volume levels and for extended durations can damage one's hearing. In order to reduce the risk of damage to hearing, one should lower the volume to a safe, comfortable level, and reduce the amount of time listening at high levels.

- The appliance coupler is used as disconnect device, the disconnect device shall remain readily operable.
- When not in use and during movement, please take care of the power cord set, e.g. tie up the power cord set with cable tie or something like that. It shall be free from sharp edges and the like that can cause abrasion of the power cord set. When put into use again, please make sure the power cord set being not damaged, If any damages found, please look for the service person to replace the power cord set specified by the manufacturer or have the same characteristics as the original one.
- Attention should be drawn to environmental aspects of battery disposal.
- No naked flame sources, such as lighted candles, should be placed on the apparatus. To prevent the spread of fire, keep candles or other open flames away from the apparatus at all times.
- Adapter Information
 * Manufacturer: SHENZHEN SHI YING YUAN ELECTRONICS CO.,LTD.
 * Model: CGSW48E-120-4000I * Input: 100-240V~50/60Hz 1.3A * Output: 12.0V \equiv 4.0A 48.0W

- Warning for Apparatus containing COIN / BUTTON CELL BATTERIES (Below instruction only used for the apparatus containing a user-replaceable coin/button cell battery)

WARNING:

Do not ingest the battery, Chemical Burn Hazard (The remote control supplied with) this product contains a coin/button cell battery. If the coin/button cell battery is swallowed, it can cause severe internal burns in just 2 hours and can lead to death. Keep new and used batteries away from children. If the battery compartment does not close securely, stop using the product and keep it away from children. If you think batteries might have been swallowed or placed inside any part of the body, seek immediate medical attention.



This lightning flash with arrowhead symbol within an equilateral triangle is intended to alert the user to the presence of non-insulated "dangerous voltage" within the product's enclosure that may be of sufficient magnitude to constitute a risk of electric shock.

- To reduce the risk of electric shock. Do not remove cover (or back). No user serviceable parts inside. Refer to qualified service personnel.
- The exclamation point within an equilateral triangle is intended to alert the user to the presence of important operating and maintenance instructions in the literature accompanying the appliance.
- The following information are recommended to be included as far as applicable where applicable:

	Refer to alternating current(AC).		Refer to stand-by or power on.
	Refer to direct current(DC).		Refer to power on.
	Refer to ClassII equipment.		Refer to dangerous voltage.

➤ WEEE Directive



Correct Disposal of this product. This marking indicates that this product should not be disposed with other household wastes throughout the EU. To prevent possible harm to the environment or human health from uncontrolled waste disposal, recycle it responsibly to promote the sustainable reuse of material resources. To return your used device, please use the return and collection systems or contact the retailer where the product was purchased. They can take this product for environmental safe recycling.

➤ Trouble Shooting

Issue	Solutions
The monitor can't be turned on.	<ul style="list-style-type: none"> • Check if the power adapter is correctly connected to the monitor and the power outlet. • Press the POWER control button on the monitor.
The picture is dark.	<ul style="list-style-type: none"> • Adjust the brightness and contrast settings.
Picture is jittering and rippling.	<ul style="list-style-type: none"> • Keep the monitor far away from other electronic devices to avoid electronic interference.
Power indicator is lit, but there is no picture or no signal.	<ul style="list-style-type: none"> • Check if your PC is turned on. • Check if the graphic card is correctly inserted in your PC. • Check if the signal cable is connected correctly and fully to the monitor and your PC. • Check if the signal cable is damaged.
"Out of Range" is displayed on the monitor.	<ul style="list-style-type: none"> • Please set to the resolution specified in the SPECIFICATION page of this manual.

► Mounting on a Wall

- An optional wall mount can be used with your monitor. Consult with your local dealer to purchase the recommended wall mount bracket.
- Carefully attach the wall mount bracket at the rear of the monitor. Install the wall mount bracket on a solid wall perpendicular to the floor.
- Disconnect the power adapter or the power cord before moving or installing the monitor. Otherwise electric shock may occur.
- Remove the stand before installing the monitor on a wall mount by performing the stand attachment in reverse.
- If you install the monitor on a ceiling or slanted wall, it may fall and result in severe personal injury. Use an authorized wall mount and contact the local dealer or qualified personnel. Otherwise it is not covered by the warranty.
- Do not over tighten the screws as this may cause damage to the monitor and void your warranty.
- To prevent injury, this apparatus must be securely attached to the wall in accordance with the installation instructions.
- Use the screws and wall mounts that meet the following specifications. Any damages or injuries by misuse or using an improper accessory are not covered by the warranty.

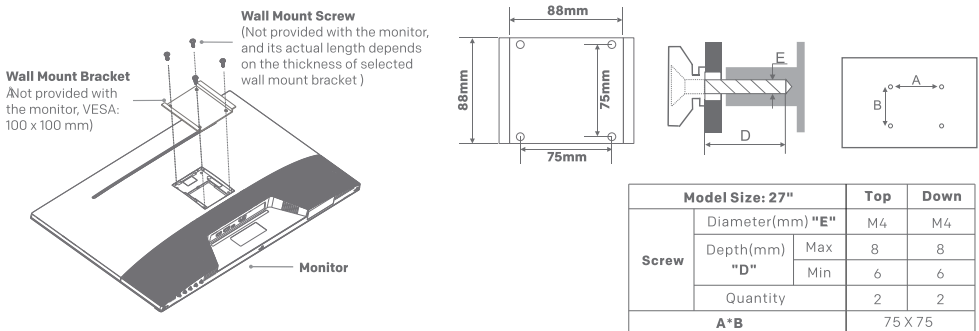

1. The pictures are only for reference.

2. Install the monitor at least 100 mm away from the wall and leave about 100 mm of space at each side of the monitor to ensure sufficient ventilation.

Service, Warranty and Pixel Policy

Dustin rules for Voxicon Displays regarding Service, Warranty and Pixel Policy

● Pixel Policy Rules

Dustin's Pixel Policy for VOXICON

Displays: Dustin will judge pixel error on VOXICON according to ISO 13406-2 class 2, allowing maximum 2 constant bright pixels, 2 constantly dark pixels, 5 defective subpixels, 2 cluster errors (incorrect pixels in a 5 * 5 pixel range). Totally ok with a maximum of 5 defective pixels. This per 1 million pixels.

● Warranty Rules and DOA

Warranty times for VOXICON:
Displays: 3 years warranty.

Rules regarding DOA products:

DOA time limit: The customer has 14 days from receipt of the product to report a DOA to Dustin.

