



# BTSID1 BTSMP1

---

Bluetooth® beacon and sensor

Quick Manual v4.9

# CONTENT

Introduction .....	3
Know your device .....	4
Configuration .....	6
Mounting recommendations .....	10
Product information .....	12
Certification .....	14
Safety information .....	15
Warranty .....	16
Warranty disclaimer .....	17

# INTRODUCTION

This document provides short instruction how to configure BTSID1 Beacon or BTSMP1 Sensor and FM tracker. During the use if you will have any questions or suggestions for improvement please feel free to contact yours Teltonika account manager or write to technical support team over VIP helpdesk.

Wireless solutions open up new horizons for your business and help to keep an eye on your assets. Discover our certified Bluetooth® Low Energy ID beacon and sensor models from Teltonika with robust water-resistant casing and a long-lifetime battery. The models designed for a low-cost fast and easy configuration and integration to save precious time, resources, and ensure accountability.

## **About BTSID1:**

Perfect for traceability use cases, delivery tracking, monitoring of various movable objects in logistics (trailers, containers), agriculture (tractor attachments), and constructions (tools and inventory). Also, it suitable for indoor tracking solutions for items tracking in warehouses, hospitals, transport hubs and other types of industrial areas. EYE beacon supports iBeacon and Eddystone protocols. The device is fully compatible with the Teltonika firmware platform which provides extended functionality.

## **About BTSMP1:**

Perfect for traceability use cases, delivery tracking, monitoring of various movable objects in logistics (trailers, containers), agriculture (tractor attachments), and constructions (tools and inventory). Sensors data makes it especially suitable for cold chain refrigerator use cases. The built-in accelerometer can detect item movement, pitch and roll of the device. Magnet detection can be used for wireless open/close detection and notifications such as trailer door events, etc. EYE sensor supports iBeacon and Eddystone protocols. The device is fully compatible with the Teltonika firmware platform which provides extended functionality.

# KNOW YOUR DEVICE

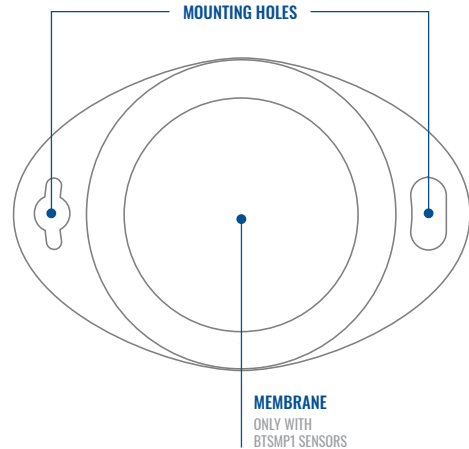

**What you get:**

- Bluetooth® **BTSID1 Beacon or BTSMP1 Sensor** designed for easy & fast configuration and integration.
- Quick Manual
- Mobile application for Android and iOS\* phones. Configure, scan, and update anytime anywhere with a **EYE APP** - Teltonika.

\*iOS doesn't show devices with iBeacon protocol

# CONFIGURATION

Devices work constantly and are ready to perform out of the box. Default basic Eye Beacon and Sensor settings are set to:

- Transmitting at 2 dBm power.
- Data advertising at 5 second intervals.
- Eddystone protocol (EYE Beacon) Eddystone and Sensors (EYE Sensor)
- PIN 123456

If you would like to change these settings you will need to:

- 1) Download and install EYE APP - Teltonika application to change sensor settings.



\*iOS doesn't show devices with iBeacon protocol

Devices in view:

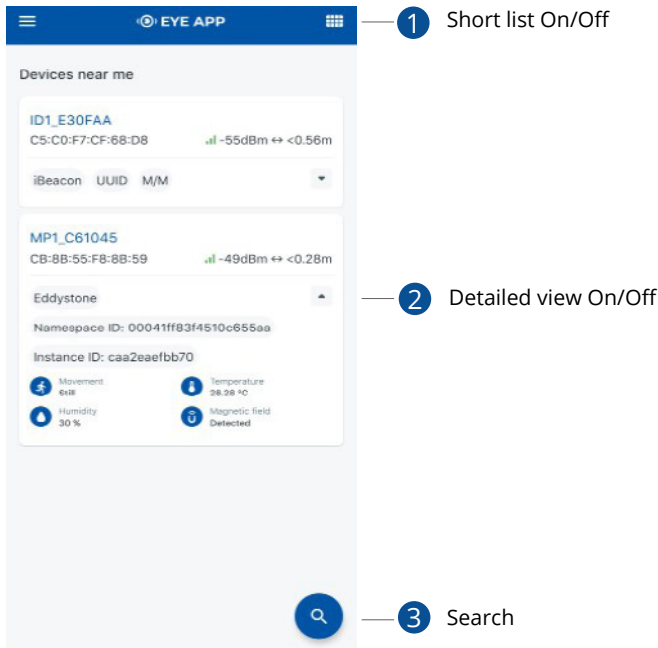

In this window you will see all visible devices. You have options to see devices in Short list (1) or in default list. When looking at devices in default list you will be able to open Detailed view (2) of devices and check transmitted data statuses. Additionally if you are looking for specific devices you will be able to use Search (3) function to filter search options. When in this window select a device of your choice to connect and after passing pin code (default pin code is 123456) you will go to device overview window.

Overview window

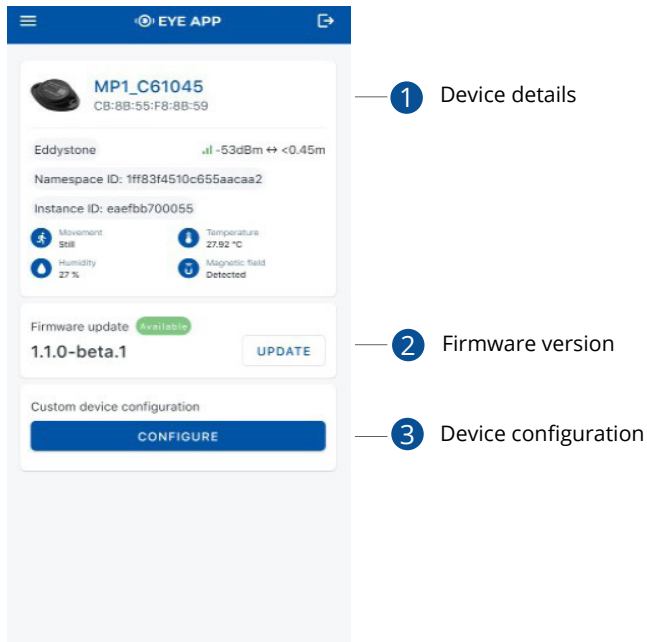

In overview window you can see device details (1), check firmware version and update if available (2), go to device configuration settings.

If you select to Configure (3) device new window will open with Basic and Advanced settings.



Configure window

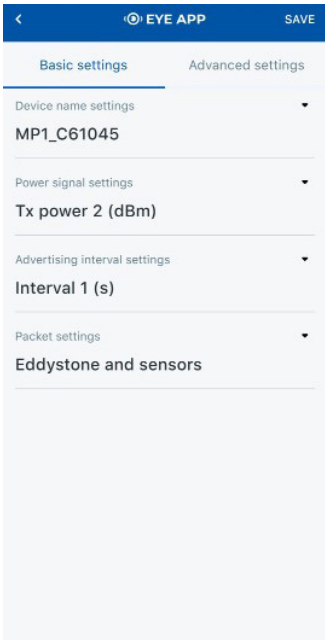

1 Save configuration

2 Configure Basic Settings

2.1 Configure device broadcast name

2.2 Configure signal strength

2.3 Configure device advertising interval

2.4 Packet settings

3 Select to configure Advanced settings.

In this window you can check and change device configuration settings. In main tab Basic Settings (1) you can change main settings. Change Device name (2.1), Power signal strength (2.2), Advertising interval (2.3) and Packet (2.4) transmission type. For more settings go to Advanced settings (3) tab to enable various events.

# MOUNTING RECOMMENDATIONS

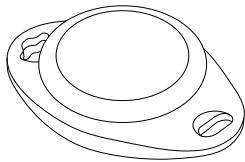

- 1 Placing: Directly place the monitor on the surface such as table, shelf

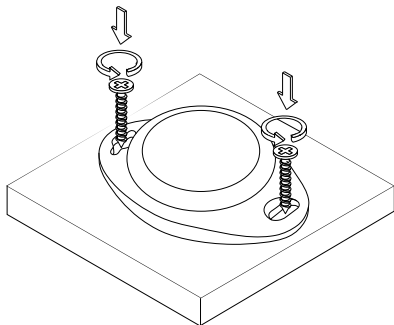

- 3 Using screws: Place device on the surface and secure it to the surface using two screws

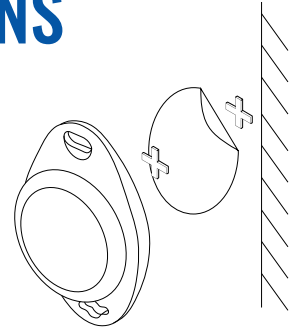

- 2 Using the adhesive sticker: Remove the release liner from one side of the adhesive sticker to stick it on the back of the device, then remove the release liner from the other side to stick it at the desired place on the wall

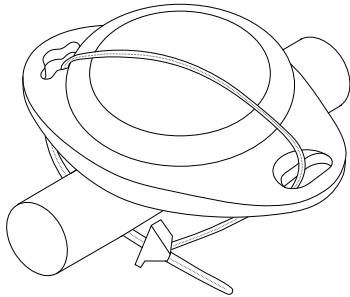

- 4** Ziptie: Lead ziptie thru both device holes and around an object you want device secured to

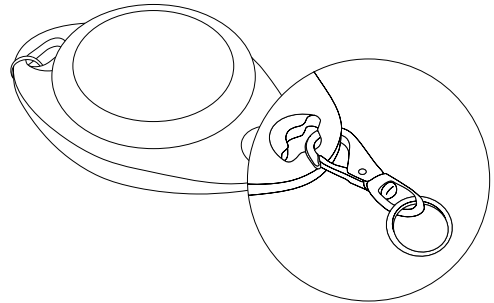

- 5** Hanging: Attach lanyard's snap hook to one of the holes

Note: Adhesive sticker, screws, lanyard, zipties are not included and sold separately

# PRODUCT INFORMATION

## Dimensions and weight



Dimensions 56,6 x 38 x 13 mm (L x W x H)

Weight 18 grams

## Technical specifications

### EYE BEACON

### EYE SENSOR

	 EYE BEACON	 EYE SENSOR
Model	CR2450	CR2450
Type	Lithium, Manganese Dioxide (Li/MnO <sub>2</sub> )	Lithium, Manganese Dioxide (Li/MnO <sub>2</sub> )
Total Capacity	600 mAh	600 mAh
Replaceable battery	No	No
Battery life (Tx=2 dBm; interval: 3 s)	4+ years	2.5+ years
Battery life (Tx=2 dBm; interval: 5 s)	8+ years (Default)	4+ years (Default)
Battery life (Tx=2 dBm; interval: 10 s)	10+ years	5+ years
Microcontroller	ST Microelectronics BlueNRG-2	ST Microelectronics BlueNRG-2
Bluetooth® technology	Bluetooth® 4.2 compliant, Bluetooth® 5.2 certified Bluetooth® Operating Frequency 2.402 - 2.480 GHz Antenna gain 1.2dBi	Bluetooth® 4.2 compliant, Bluetooth® 5.2 certified Bluetooth® Operating Frequency 2.402 - 2.480 GHz Antenna gain 1.2dBi
Range	80 m	80 m
Available transmission power levels	Up to 8 dBm	Up to 8 dBm

## Technical specifications

Sensitivity	-88 dBm	-88 dBm
Protection	IP67	IP67
Mounting	Two holes to screw/ leash/strip, tape	Two holes to screw/ leash/strip, tape
Customization	Custom logo upon request* <small>* Special conditions</small>	Custom logo upon request* <small>* Special conditions</small>
Operational temperature	-20°C / +60°C (-4°F / +140°F)	-20°C / +60°C (-4°F / +140°F)
Humidity (non-condensing)	From 0% to 100%	From 0% to 100%
Certificates	CE RED (EU) FCC (USA) UKCA (UK) RoHS E-mark EAC ANATEL REACH EU SIRIM QAS SDPPI POSTEL TELEC IP67	CE RED (EU) FCC (USA) UKCA (UK) RoHS E-mark EAC ANATEL REACH EU SIRIM QAS SDPPI POSTEL TELEC IP67
Temperature measuring range		-20 to +60°C

## CERTIFICATION

15C This device complies with part 15 of the FCC Rules. Operation is subject to the following two conditions: (1) This device may not cause harmful interference, and (2) this device must accept any interference received, including interference that may cause undesired operation.

Changes or modifications not expressly approved by the manufacturer could void the user's authority to operate the equipment. The antenna(s) used for this transmitter must not be co-located or operating in conjunction with any other antenna or transmitter.

(15B) This equipment has been tested and found to comply with the limits for a Class B digital device, pursuant to part 15 of the FCC Rules.

These limits are designed to provide reasonable protection against harmful interference in a residential installation. This equipment generates, uses and can radiate radio frequency energy and, if not installed and used in accordance with the instructions, may cause harmful interference to radio communications. However, there is no guarantee that interference will not occur in a particular installation. If this equipment does cause harmful interference to radio or television reception, which can be determined by turning the equipment off and on, the user is encouraged to try to correct the interference by one or more of the following measures:

- Reorient or relocate the receiving antenna.
- Increase the separation between the equipment and receiver.
- Connect the equipment into an outlet on a circuit different from that to which the receiver is connected.
- Consult the dealer or an experienced radio/TV technician for help.
- This device complies with FCC RF radiation exposure limits set forth for an uncontrolled environment.
- The antenna(s) used for this transmitter must not be co-located or operating in conjunction with any other antenna or transmitter and must be installed to provide a separation distance of at least 20cm from all persons.

Para maiores informações, consulte o site da ANATEL [www.gov.br/anatel/pt-br](http://www.gov.br/anatel/pt-br)  
Este equipamento não tem direito à proteção contra interferência prejudicial e não pode causar interferência em sistemas devidamente autorizados.



For more information, see the ANATEL website [www.gov.br/anatel/pt-br](http://www.gov.br/anatel/pt-br).

This equipment is not entitled to protection against harmful interference and must not cause interference in duly authorized system.

# SAFETY INFORMATION

This message contains information on how to operate BTSID1 safely. By following these requirements and recommendations, you will avoid dangerous situations. You must read these instructions carefully and follow them strictly before operating the device!

1. To avoid mechanical damage, it is advised to transport the device in an impact-proof package.
2. In case of malfunction contact yours Teltonika account manager or write to technical support team over VIP helpdesk.



Opening and self fixing devices is strictly forbidden



The device must be firmly fastened in a predefined location.



All wireless data transferring devices produce interference that may affect other devices which are placed nearby.



Installation and/or handling during a lightning storm is prohibited.



The device must be connected only by qualified personnel.



Risk of explosion if battery is replaced by an incorrect type. Dispose of used batteries according to the instructions.



The Bluetooth® word mark and logos are registered trademarks owned by Bluetooth SIG, Inc. and any use of such marks by UAB Teltonika Telematics is under license. Other trademarks and trade names are those of their respective owners.



This marking on the product, accessories or literature indicates that product and its electronic accessories should not be disposed of with other household waste.



This Marking on the battery, manual or packaging indicates that batteries in this product should not be disposed with other household waste.



# WARRANTY

We guarantee our products 24-month warranty<sup>1</sup> period.

All batteries carry a 6-month warranty period.

Post-warranty repair service for products is not provided.

If a product stops operating within this specific warranty time, the product can be:

- Repaired
- Replaced with a new product
- Replaced with an equivalent repaired product fulfilling the same functionality
- Replaced with a different product fulfilling the same functionality in case of EOL for the original product

<sup>1</sup> Additional agreement for an extended warranty period can be agreed upon separately.

# WARRANTY DISCLAIMER

- Customers are only allowed to return products as a result of the product being defective, due to order assembly or manufacturing fault.
- Products are intended to be used by personnel with training and experience.
- Warranty does not cover defects or malfunctions caused by accidents, misuse, abuse, catastrophes, improper maintenance or inadequate installation – not following operating instructions (including failure to heed warnings) or use with equipment with which it is not intended to be used.
- Warranty does not apply to any consequential damages.
- Warranty is not applicable for supplementary product equipment (i. e. PSU, power cables, antennas) unless the accessory is defective on arrival.
- [More information on what is RMA<sup>1</sup>](#)

<sup>1</sup> [wiki.teltonika-gps.com/view/RMA\\_guidelines](http://wiki.teltonika-gps.com/view/RMA_guidelines)