

5

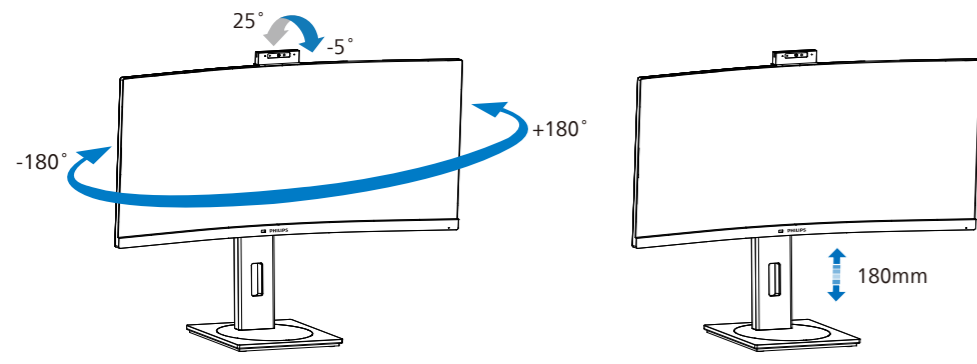

6

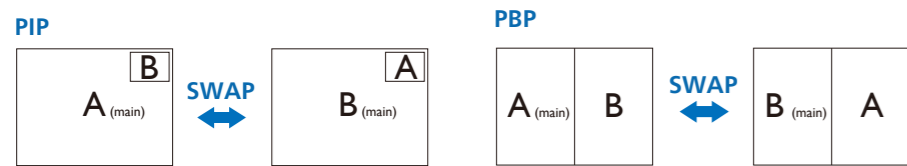
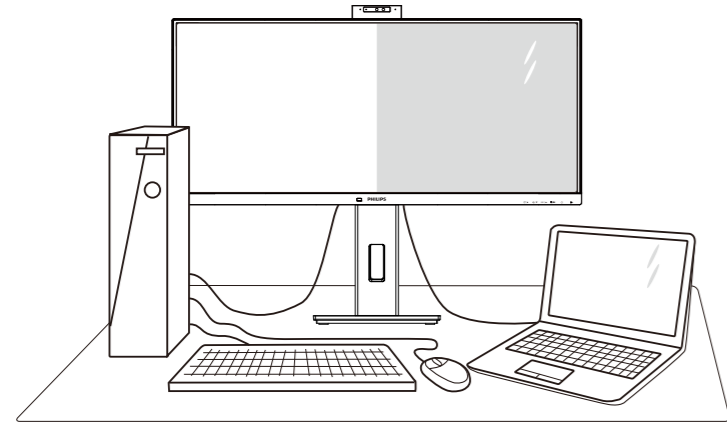

MultiView		SUB SOURCE POSSIBILITY (x1)			
		Inputs	HDMI	DisplayPort	USBC1
MAIN SOURCE (x1)	HDMI	●	●	●	●
	DisplayPort	●	●	●	●
	USBC1	●	●	●	●



Register your product and get support at www.philips.com/support



Version: M1134BU5600Q1WWT
2022 © TOP Victory Investments Ltd. All rights reserved.

This product has been manufactured by and is sold under the responsibility of Top Victory Investments Ltd., and Top Victory Investments Ltd. is the warrantor in relation to this product. Philips and the Philips Shield Emblem are registered trademarks of Koninklijke Philips N.V. and are used under license.

Specifications are subject to change without notice.

HDMI

The Adopted Trademarks HDMI, HDMI High Definition Multimedia Interface, and the HDMI Logo are trademarks or registered trademarks of HDMI Licensing Administrator, Inc. in the United States and other countries.

www.philips.com

Energy Labelling
34B1U5600CH



Printed in China



PHILIPS

Business Monitor

5000 Series



34B1U5600CH

Quick start

Register your product and get support at www.philips.com/welcome

Contents

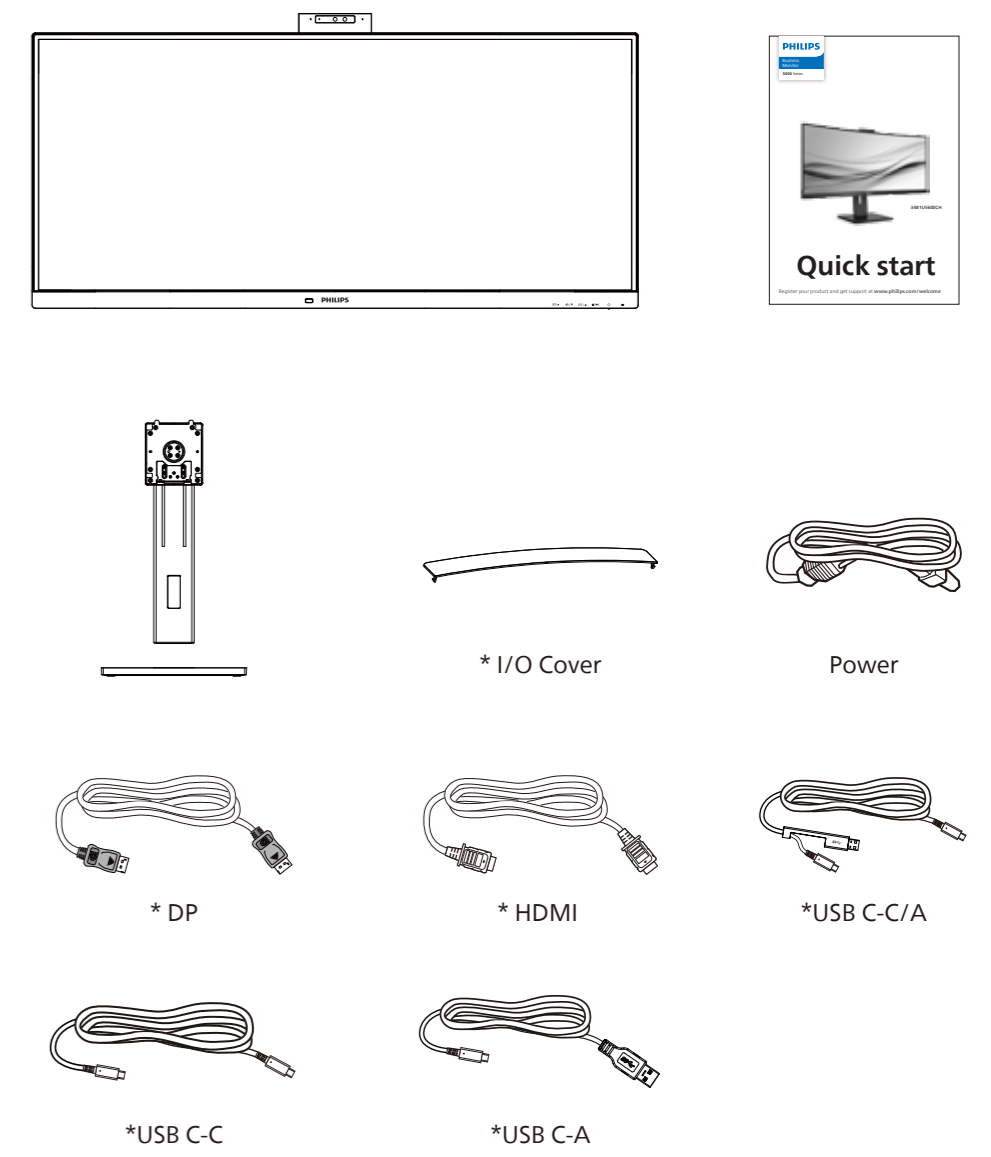

*Different according to region
Display design may differ from that illustrated

1

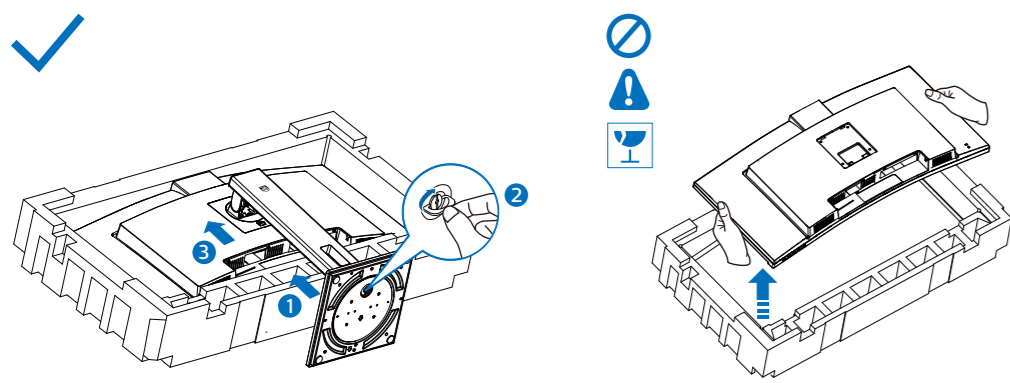

CAUTION: Place the monitor face down on a smooth surface. Pay attention not to scratch or damage the screen.

2

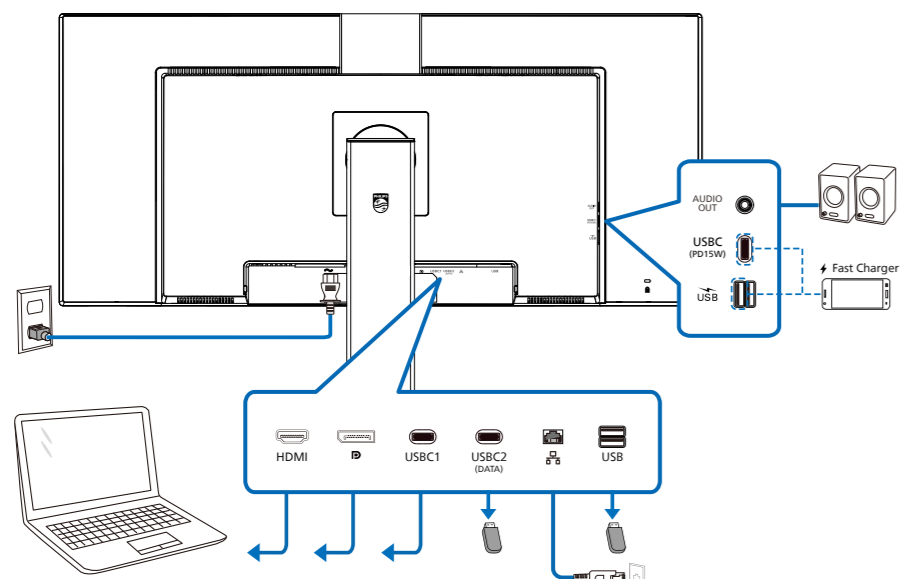

USB docking (USB C-C)

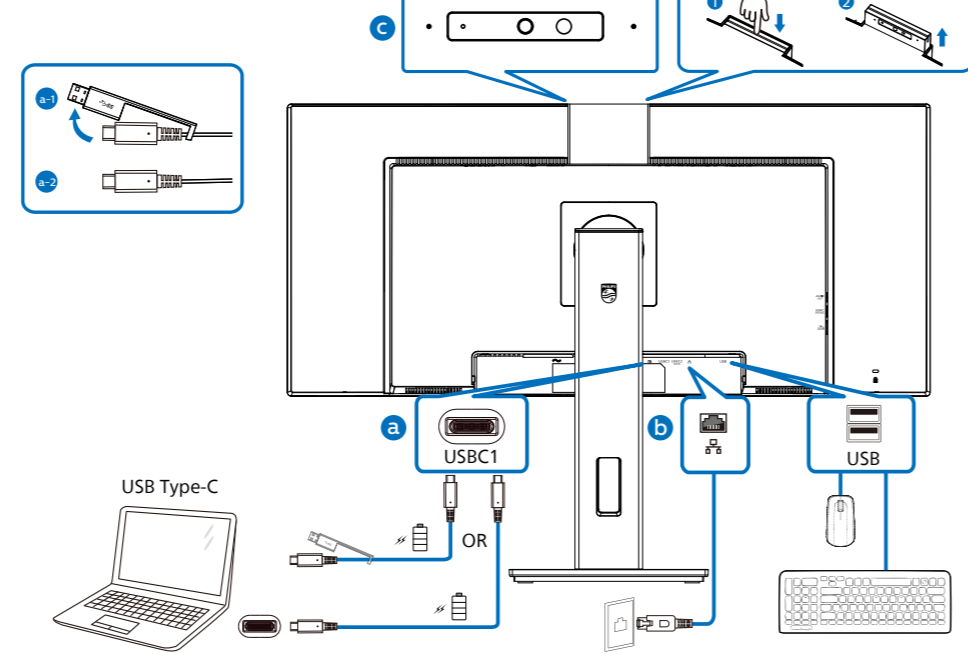

USB hub (USB A-C)

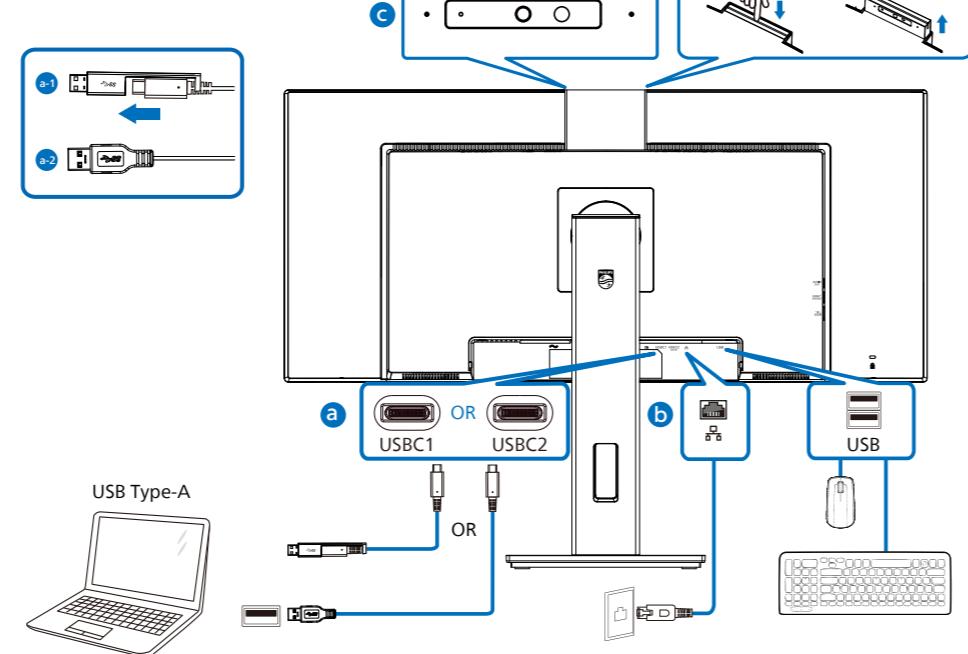

KVM

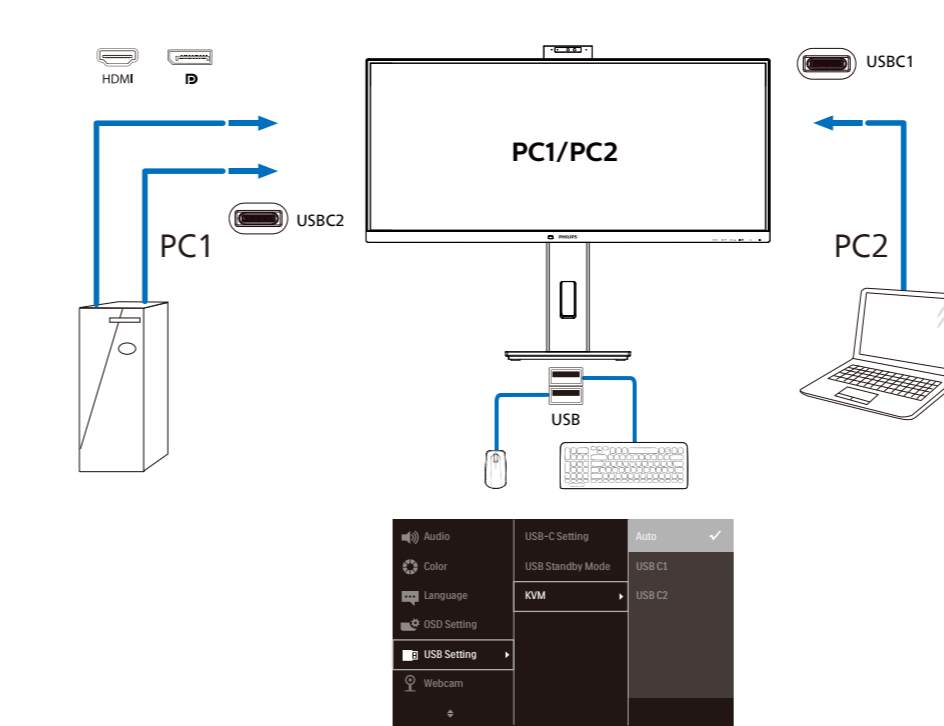

3

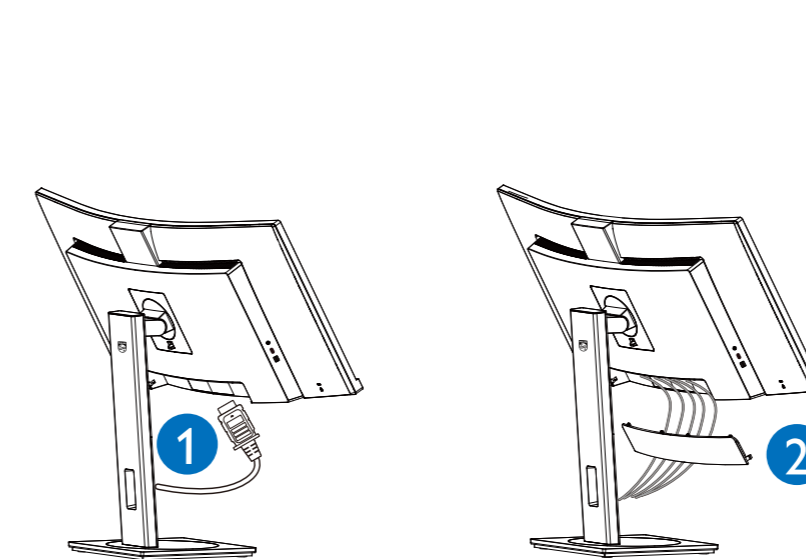

4

