

Lenovo
ThinkPad

ThinkPad E14 Gen 5

ThinkPad E16 Gen 1



Lenovo

Get started

Get started | Get started | Get started | Get started | Get started

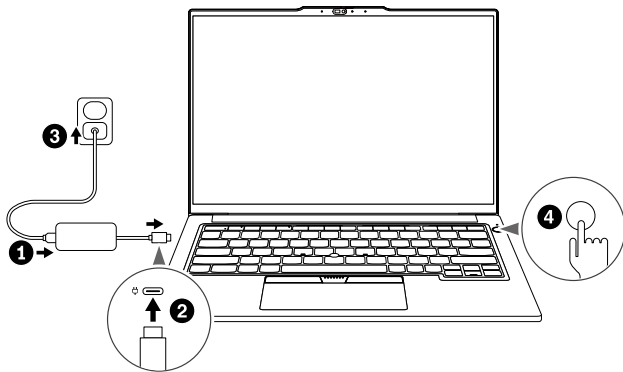



* For selected models | For selected models | For selected models | For selected models | For selected models

Front view (ThinkPad E14 Gen 5)

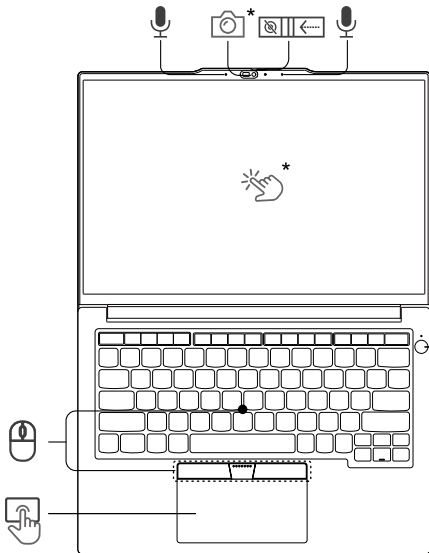
Front view | Front view | Front view | Front view | Front view





 * Press to log in to the computer*
Press to log in to the computer*
Press to log in to the computer*
Press to log in to the computer*
Press to log in to the computer*
Press to log in to the computer*

 Navigate as a traditional mouse
Navigate as a traditional mouse
Navigate as a traditional mouse
Navigate as a traditional mouse
Navigate as a traditional mouse
Navigate as a traditional mouse

Front view (ThinkPad E16 Gen 1)

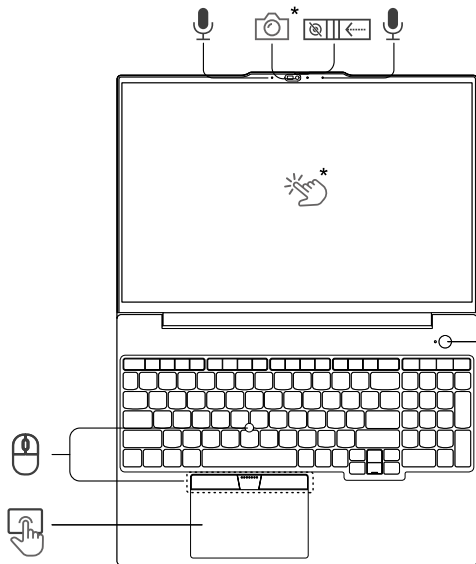
Front view | Front view | Front view | Front view | Front view



-  * Press to log in to the computer*
- Press to log in to the computer*
- Press to log in to the computer*
- Press to log in to the computer*
- Press to log in to the computer*
- Press to log in to the computer*

-  Navigate as a traditional mouse
- Navigate as a traditional mouse
- Navigate as a traditional mouse
- Navigate as a traditional mouse
- Navigate as a traditional mouse
- Navigate as a traditional mouse

Side view

Side view | Side view | Side view | Side view | Side view

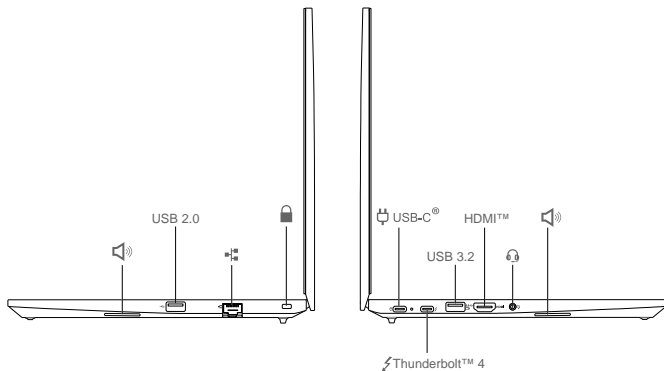

Read the statement on USB transfer rate in the User Guide. To access the User Guide, go to <https://pcsupport.lenovo.com>.
Read the statement on USB transfer rate in the User Guide. To access the User Guide, go to <https://pcsupport.lenovo.com>.
Read the statement on USB transfer rate in the User Guide. To access the User Guide, go to <https://pcsupport.lenovo.com>.
Read the statement on USB transfer rate in the User Guide. To access the User Guide, go to <https://pcsupport.lenovo.com>.
Read the statement on USB transfer rate in the User Guide. To access the User Guide, go to <https://pcsupport.lenovo.com>.
Read the statement on USB transfer rate in the User Guide. To access the User Guide, go to <https://pcsupport.lenovo.com>.
Read the statement on USB transfer rate in the User Guide. To access the User Guide, go to <https://pcsupport.lenovo.com>.

Lenovo Vantage*

Access Lenovo Vantage to adjust device settings and check for system updates.

Access Lenovo Vantage to adjust device settings and check for system updates.

Access Lenovo Vantage to adjust device settings and check for system updates.

Access Lenovo Vantage to adjust device settings and check for system updates.

Access Lenovo Vantage to adjust device settings and check for system updates.

Access Lenovo Vantage to adjust device settings and check for system updates.

Access Lenovo Vantage to adjust device settings and check for system updates.

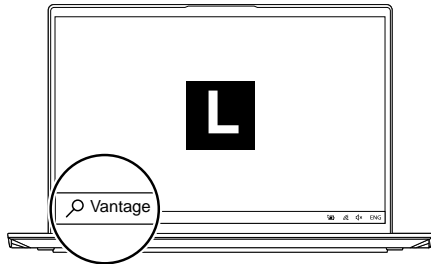

Lenovo Smart Appearance*



Video Enhancer | Video Enhancer
Video Enhancer | Video Enhancer
Video Enhancer | Video Enhancer

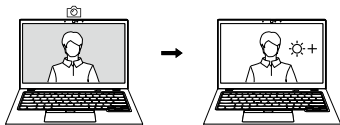

Background | Background
Background | Background
Background | Background

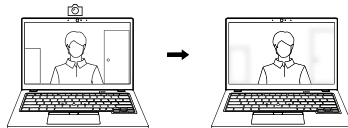

Privacy Protection | Privacy Protection
Privacy Protection | Privacy Protection
Privacy Protection | Privacy Protection

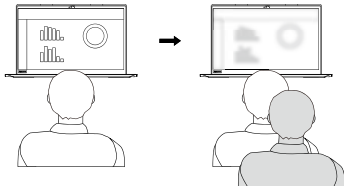

Adaptive Dimming | Adaptive Dimming
Adaptive Dimming | Adaptive Dimming
Adaptive Dimming | Adaptive Dimming

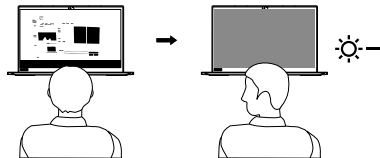

[English]

Specific absorption rate (SAR)

YOUR DEVICE MEETS INTERNATIONAL GUIDELINES FOR EXPOSURE TO RADIO WAVES.

Refer to the following for 10g SAR limit and maximum reported SAR values:

10g SAR limit: 2 W/kg (body-worn SAR); 4 W/kg (limb SAR)

Maximum SAR with 0 mm separation distance:

Product name	Body-worn SAR value	Limb SAR value
ThinkPad E14 Gen 5	0.342 W/kg	0.761 W/kg
ThinkPad E16 Gen 1	0.45 W/kg	0.867 W/kg

For more information about SAR, refer to the Safety and Warranty Guide that came with your device.

European Union (EU) / United Kingdom (UK) — radio frequency and power

This radio equipment operates with the following frequency bands and maximum radio-frequency power:

Technology	Frequency [MHz] / band	Maximum transmit power
WLAN 802.11b/g/n/ax	2400 - 2483.5	< 20 dBm
WLAN 802.11a/n/ac/ax	5150 - 5725	< 23 dBm
WLAN 802.11a/n/ac/ax	5725 - 5875	< 13.98 dBm
WLAN 802.11ax	5945 - 6425	< 23 dBm
Bluetooth BR/EDR/LE	2400 - 2483.5	< 20 dBm

Note: Not all wireless bands may be enabled depending on your product configuration. Usage of this device is limited to indoor locations in the bands 5150 - 5350 MHz and 5945 - 6425 MHz.

[English]

Specific absorption rate (SAR)

YOUR DEVICE MEETS INTERNATIONAL GUIDELINES FOR EXPOSURE TO RADIO WAVES.

Refer to the following for 10g SAR limit and maximum reported SAR values:

10g SAR limit: 2 W/kg (body-worn SAR); 4 W/kg (limb SAR)

Maximum SAR with 0 mm separation distance:

Product name	Body-worn SAR value	Limb SAR value
ThinkPad E14 Gen 5	0.342 W/kg	0.761 W/kg
ThinkPad E16 Gen 1	0.45 W/kg	0.867 W/kg

For more information about SAR, refer to the Safety and Warranty Guide that came with your

device.

European Union (EU) / United Kingdom (UK) — radio frequency and power

This radio equipment operates with the following frequency bands and maximum radio-frequency power:

Technology	Frequency [MHz] / band	Maximum transmit power
WLAN 802.11b/g/n/ax	2400 - 2483.5	< 20 dBm
WLAN 802.11a/n/ac/ax	5150 - 5725	< 23 dBm
WLAN 802.11a/n/ac/ax	5725 - 5875	< 13.98 dBm
WLAN 802.11ax	5945 - 6425	< 23 dBm
Bluetooth BR/EDR/LE	2400 - 2483.5	< 20 dBm

Note: Not all wireless bands may be enabled depending on your product configuration. Usage of this device is limited to indoor locations in the bands 5150 - 5350 MHz and 5945 - 6425 MHz.

[English]

Specific absorption rate (SAR)

YOUR DEVICE MEETS INTERNATIONAL GUIDELINES FOR EXPOSURE TO RADIO WAVES.

Refer to the following for 10g SAR limit and maximum reported SAR values:

10g SAR limit: 2 W/kg (body-worn SAR); 4 W/kg (limb SAR)

Maximum SAR with 0 mm separation distance:

Product name	Body-worn SAR value	Limb SAR value
ThinkPad E14 Gen 5	0.342 W/kg	0.761 W/kg
ThinkPad E16 Gen 1	0.45 W/kg	0.867 W/kg

For more information about SAR, refer to the Safety and Warranty Guide that came with your device.

European Union (EU) / United Kingdom (UK) — radio frequency and power

This radio equipment operates with the following frequency bands and maximum radio-frequency power:

Technology	Frequency [MHz] / band	Maximum transmit power
WLAN 802.11b/g/n/ax	2400 - 2483.5	< 20 dBm
WLAN 802.11a/n/ac/ax	5150 - 5725	< 23 dBm
WLAN 802.11a/n/ac/ax	5725 - 5875	< 13.98 dBm
WLAN 802.11ax	5945 - 6425	< 23 dBm
Bluetooth BR/EDR/LE	2400 - 2483.5	< 20 dBm

Note: Not all wireless bands may be enabled depending on your product configuration. Usage of this device is limited to indoor locations in the bands 5150 - 5350 MHz and 5945 - 6425 MHz.

[English]

Specific absorption rate (SAR)

YOUR DEVICE MEETS INTERNATIONAL GUIDELINES FOR EXPOSURE TO RADIO WAVES.

Refer to the following for 10g SAR limit and maximum reported SAR values:

10g SAR limit: 2 W/kg (body-worn SAR); 4 W/kg (limb SAR)

Maximum SAR with 0 mm separation distance:

Product name	Body-worn SAR value	Limb SAR value
ThinkPad E14 Gen 5	0.342 W/kg	0.761 W/kg
ThinkPad E16 Gen 1	0.45 W/kg	0.867 W/kg

For more information about SAR, refer to the Safety and Warranty Guide that came with your device.

European Union (EU) / United Kingdom (UK) — radio frequency and power

This radio equipment operates with the following frequency bands and maximum radio-frequency power:

Technology	Frequency [MHz] / band	Maximum transmit power
WLAN 802.11b/g/n/ax	2400 - 2483.5	< 20 dBm
WLAN 802.11a/n/ac/ax	5150 - 5725	< 23 dBm
WLAN 802.11a/n/ac/ax	5725 - 5875	< 13.98 dBm
WLAN 802.11ax	5945 - 6425	< 23 dBm
Bluetooth BR/EDR/LE	2400 - 2483.5	< 20 dBm

Note: Not all wireless bands may be enabled depending on your product configuration. Usage of this device is limited to indoor locations in the bands 5150 - 5350 MHz and 5945 - 6425 MHz.

[English]

Specific absorption rate (SAR)

YOUR DEVICE MEETS INTERNATIONAL GUIDELINES FOR EXPOSURE TO RADIO WAVES.

Refer to the following for 10g SAR limit and maximum reported SAR values:

10g SAR limit: 2 W/kg (body-worn SAR); 4 W/kg (limb SAR)

Maximum SAR with 0 mm separation distance:

Product name	Body-worn SAR value	Limb SAR value
ThinkPad E14 Gen 5	0.342 W/kg	0.761 W/kg
ThinkPad E16 Gen 1	0.45 W/kg	0.867 W/kg

For more information about SAR, refer to the Safety and Warranty Guide that came with your device.

European Union (EU) / United Kingdom (UK) — radio frequency and power

This radio equipment operates with the following frequency bands and maximum radio-frequency power:

Technology	Frequency [MHz] / band	Maximum transmit power
WLAN 802.11b/g/n/ax	2400 - 2483.5	< 20 dBm
WLAN 802.11a/n/ac/ax	5150 - 5725	< 23 dBm
WLAN 802.11a/n/ac/ax	5725 - 5875	< 13.98 dBm
WLAN 802.11ax	5945 - 6425	< 23 dBm
Bluetooth BR/EDR/LE	2400 - 2483.5	< 20 dBm

Note: Not all wireless bands may be enabled depending on your product configuration. Usage of this device is limited to indoor locations in the bands 5150 - 5350 MHz and 5945 - 6425 MHz.

[English]

Specific absorption rate (SAR)

YOUR DEVICE MEETS INTERNATIONAL GUIDELINES FOR EXPOSURE TO RADIO WAVES.

Refer to the following for 10g SAR limit and maximum reported SAR values:

10g SAR limit: 2 W/kg (body-worn SAR); 4 W/kg (limb SAR)

Maximum SAR with 0 mm separation distance:

Product name	Body-worn SAR value	Limb SAR value
ThinkPad E14 Gen 5	0.342 W/kg	0.761 W/kg
ThinkPad E16 Gen 1	0.45 W/kg	0.867 W/kg

For more information about SAR, refer to the Safety and Warranty Guide that came with your device.

European Union (EU) / United Kingdom (UK) — radio frequency and power

This radio equipment operates with the following frequency bands and maximum radio-frequency power:

Technology	Frequency [MHz] / band	Maximum transmit power
WLAN 802.11b/g/n/ax	2400 - 2483.5	< 20 dBm

Technology	Frequency [MHz] / band	Maximum transmit power
WLAN 802.11a/n/ac/ax	5150 - 5725	< 23 dBm
WLAN 802.11a/n/ac/ax	5725 - 5875	< 13.98 dBm
WLAN 802.11ax	5945 - 6425	< 23 dBm
Bluetooth BR/EDR/LE	2400 - 2483.5	< 20 dBm

Note: Not all wireless bands may be enabled depending on your product configuration. Usage of this device is limited to indoor locations in the bands 5150 - 5350 MHz and 5945 - 6425 MHz.

[English]

Specific absorption rate (SAR)

YOUR DEVICE MEETS INTERNATIONAL GUIDELINES FOR EXPOSURE TO RADIO WAVES.

Refer to the following for 10g SAR limit and maximum reported SAR values:

10g SAR limit: 2 W/kg (body-worn SAR); 4 W/kg (limb SAR)

Maximum SAR with 0 mm separation distance:

Product name	Body-worn SAR value	Limb SAR value
ThinkPad E14 Gen 5	0.342 W/kg	0.761 W/kg
ThinkPad E16 Gen 1	0.45 W/kg	0.867 W/kg

For more information about SAR, refer to the Safety and Warranty Guide that came with your device.

European Union (EU) / United Kingdom (UK) — radio frequency and power

This radio equipment operates with the following frequency bands and maximum radio-frequency power:

Technology	Frequency [MHz] / band	Maximum transmit power
WLAN 802.11b/g/n/ax	2400 - 2483.5	< 20 dBm
WLAN 802.11a/n/ac/ax	5150 - 5725	< 23 dBm
WLAN 802.11a/n/ac/ax	5725 - 5875	< 13.98 dBm
WLAN 802.11ax	5945 - 6425	< 23 dBm
Bluetooth BR/EDR/LE	2400 - 2483.5	< 20 dBm

Note: Not all wireless bands may be enabled depending on your product configuration. Usage of this device is limited to indoor locations in the bands 5150 - 5350 MHz and 5945 - 6425 MHz.

For Barcode Position Only

PN: xxxxxxxxx Printed in China

First Edition (April 2023)

© Copyright Lenovo 2023.

LIMITED AND RESTRICTED RIGHTS NOTICE: If data or software is delivered pursuant to a General Services Administration "GSA" contract, use, reproduction, or disclosure is subject to restrictions set forth in Contract No. GS-35F-05925.

Lenovo, Lenovo logo, ThinkPad, and ThinkPad logo are trademarks of Lenovo. Intel and Thunderbolt are trademarks of Intel Corporation or its subsidiaries in the U.S. and/or other countries. The terms HDMI and HDMI High-Definition Multimedia Interface are trademarks or registered trademarks of HDMI Licensing LLC in the United States and other countries. USB-C is a registered trademark of USB Implementers Forum. All other trademarks are the property of their respective owners.



Reduce
Reuse
Recycle

For FSC Mix logo only

For Clearance Position Only

PN: xxxxxxxx Printed in China

Lenovo

First Edition (April 2023)

© Copyright Lenovo 2023.

LIMITED AND RESTRICTED RIGHTS NOTICE: If data or software is delivered pursuant to a General Services Administration "GSA" contract, use, reproduction, or disclosure is subject to restrictions set forth in Contract No. GS-35F-05925.

Lenovo, Lenovo logo, ThinkPad, and ThinkPad logo are trademarks of Lenovo. Intel and Thunderbolt are trademarks of Intel Corporation or its subsidiaries in the U.S. and/or other countries. The terms HDMI and HDMI High-Definition Multimedia Interface are trademarks or registered trademarks of HDMI Licensing LLC in the United States and other countries. USB-C is a registered trademark of USB Implementers Forum. All other trademarks are the property of their respective owners.



Reduce
Reuse
Recycle

For FSC Mix logo only