



Product Data Sheet

WMM8G-7-27

C/Note	Doc Issue	Date	Approval
01019	B	17.03.14	J.J.

PANORAMA  ANTENNAS

2G/3G/4G

Wall Mount Gain MiMo Antenna



WMM8G-7-27

- Supports MiMo & diversity across 3G & 4G
- Two wideband elements with gain
- Durable wall mount housing
- Suitable for mast, wall and desk mounting

The WMM8G-7-27 antenna is a high directional gain 2x2 MiMo signal boosting antenna for 2G, 3G and 4G networks. Incorporating two separately fed wideband elements in a single housing the WMM8G-7-27 is equipped to provide client side MiMo and diversity support for 2G, 3G and 4G networks. With 6dBi of peak gain at 800-960MHz, 9dBi peak gain at 1710-2700MHz and fallback gain of 2dBi at 698-800MHz the WMM8G-7-27 provides extra gain for next generation networks.

The rugged, weather resistant housing is designed for wall mounting and wall and mast mount brackets are provided. Supplied with fitted low loss double shielded twin cable the WMM8G-7-27 minimises exposed connector joints and simplifies cable management for easy installation.

The WMM8G-7-27 is a cost effective value added product for network operators and service providers ensuring a stable link with improved data rates for subscribers thereby improving satisfaction and retention.

Technical Drawing

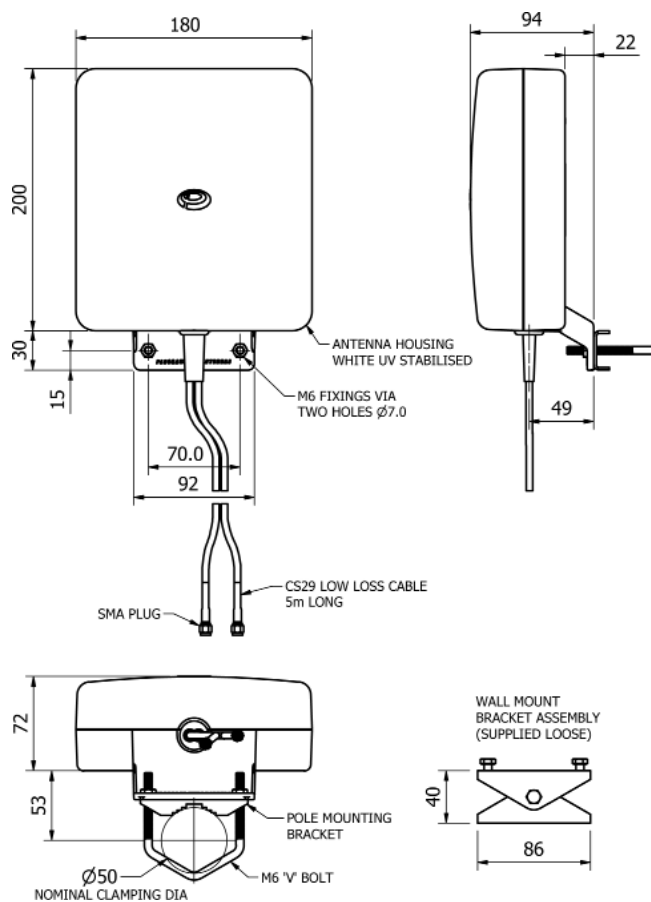

2G/3G/4G Wall Mount Gain MiMo Antenna

Typical VSWR Elements 1 & 2 *

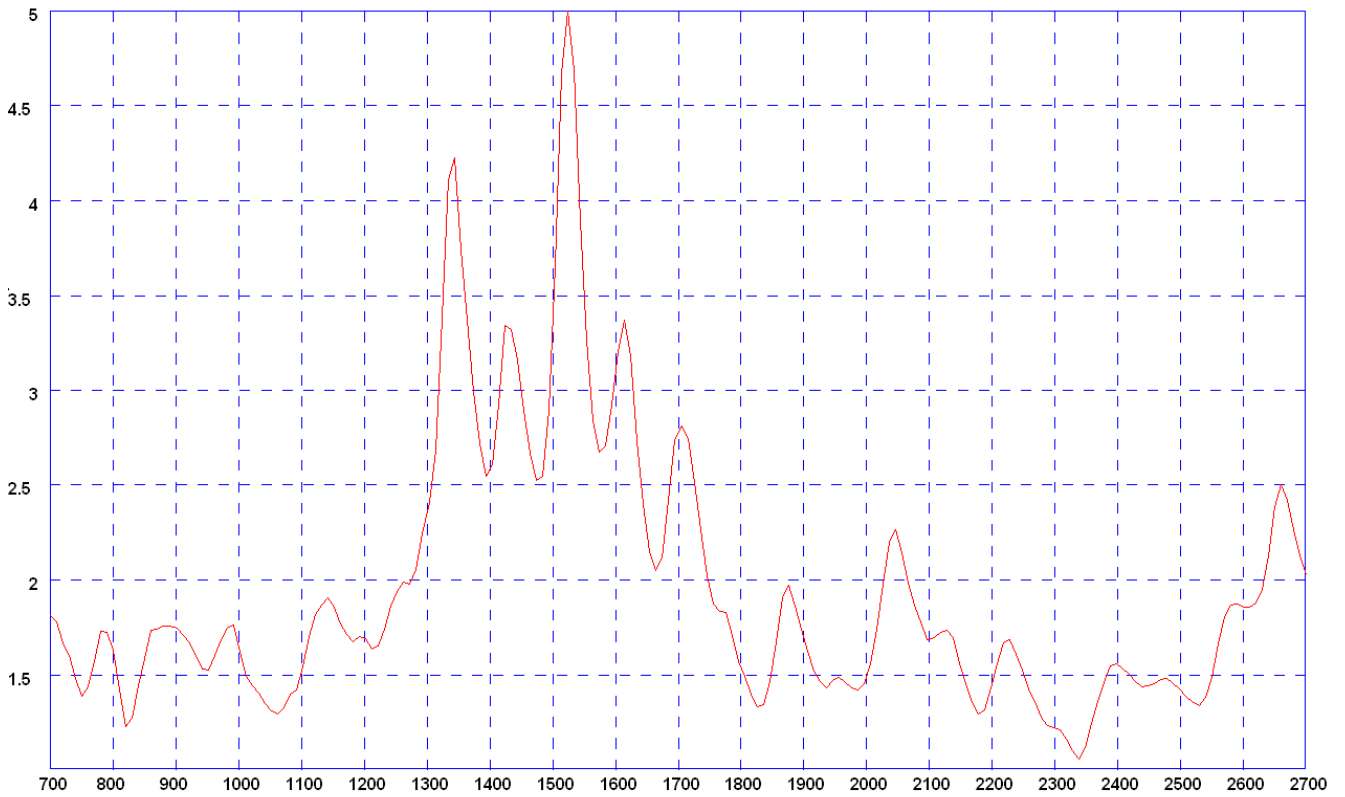

*VSWR measured with 0.5m (20") of CS29 cable.

3D Gain Plot (850MHz)

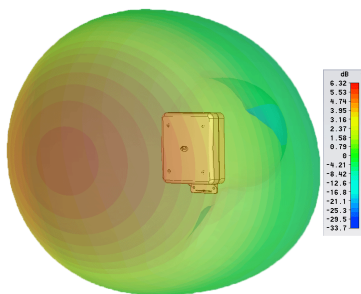

3D Gain Plot (950MHz)

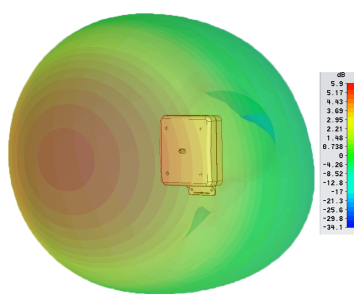

3D Gain Plot (1850MHz)

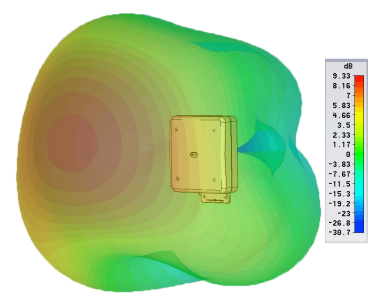

3D Gain Plot (2100MHz)

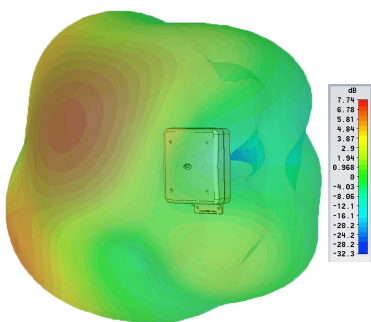

3D Gain Plot (2400MHz)

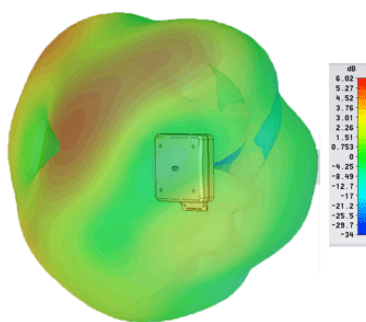

3D Gain Plot (2600MHz)

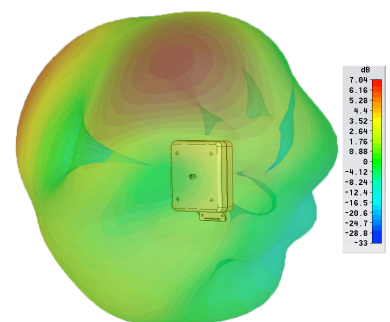

*3D Patterns show realised gain both elements fed.

2G/3G/4G

Wall mount Gain MiMo Antenna

Part No.		WMM8G-7-27-5SP
Electrical Data		
Frequency Range (MHz)	Antenna 1	698-960/1710-2700
	Antenna 2	698-960/1710-2700
Operational bands	2G / 3G / 4G	
Radiation pattern	Directional	
Peak Gain (excl cable loss)	698-800 MHz	2dBi
	800-960 MHz	6dBi
	1710-2170 MHz	9dBi
	2396-2700 MHz	6dBi
Efficiency - excluding cable loss (all bands)	> 65%	
Correlation co-efficient (all bands)	< 0.05	
Max input power (W)	20 Watts	
Nominal Impedance	50Ω	
Mechanical Data		
Dimensions (mm)	Height	230 (9")
	Width	180 (7.1")
	Depth	94 (3.7")
Operating temp (°C)	-30° / +70°C (-22° /158°F)	
Material	U.V. stable, impact resistant ASA	
Colour	RAL9010 (Pure White)	
Mounting Data		
Fixing	Wall mount / mast mount / desk mount	
Mounting bracket material	Stainless steel / Aluminium	
Pole diameter (mm)	20-50 / (0.78 - 1.96")	
Cable Data		
Type	2 x CS29 Coax (double shielded RG58)	
Diameter (mm)	5 (0.2")	
Length (m)	5 (16')	
Termination	2 x SMA (m)	
Adaptor Pigtails	Supplied separately	

Panorama Antennas Ltd

Frogmore, London, SW18 1HF, United Kingdom

T: +44 (0)20 8877 4444

F: +44 (0)20 8877 4477

E: sales@panorama-antennas.com

www.panorama-antennas.com

PANORAMA  ANTENNAS

Waiver: The data given above is indicative of the performance of the product/s under particular conditions and does not imply a guarantee of performance. These specifications are subject to change without notice.

Copyright © Panorama Antennas Ltd. All rights reserved.