

# ThinkPad<sup>®</sup> L14 Gen 4 / L15 Gen 4

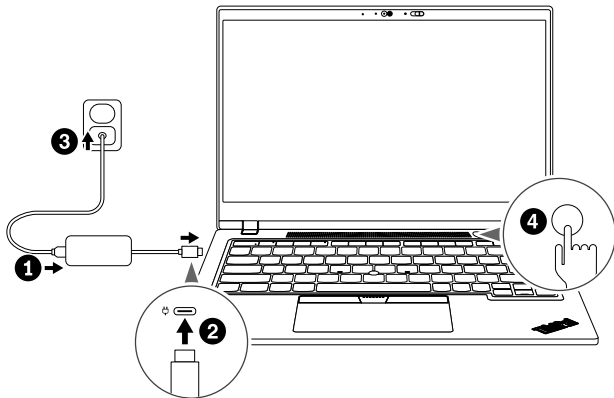

# Get started

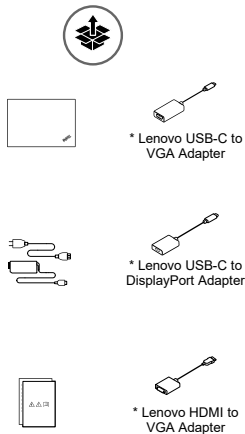

\* For selected models | For selected models | For selected models | For selected models | For selected models

## Front view

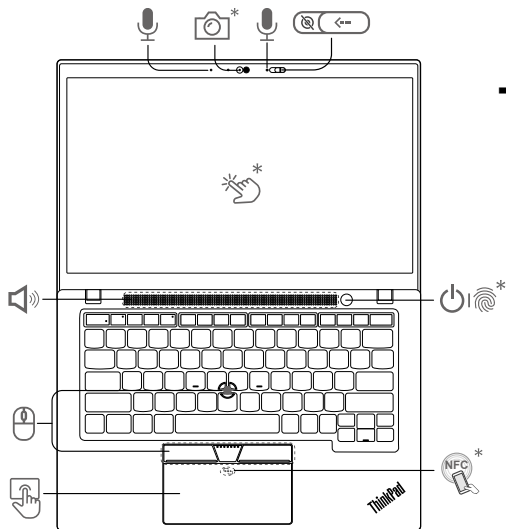

# ThinkPad L14 Gen 4

 \* Press to log in to the computer\*

## Front view

# ThinkPad L15 Gen 4



Press to log in to the computer\*

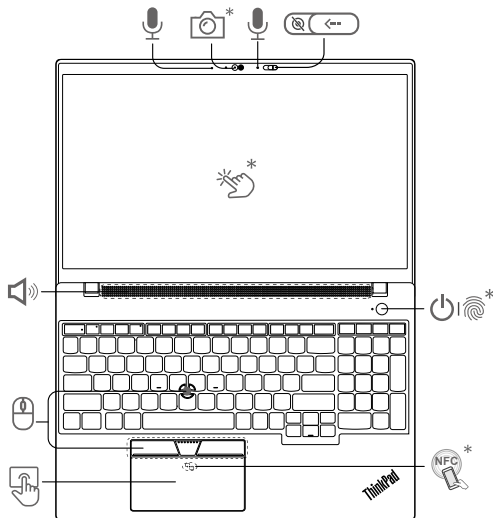

## Overview

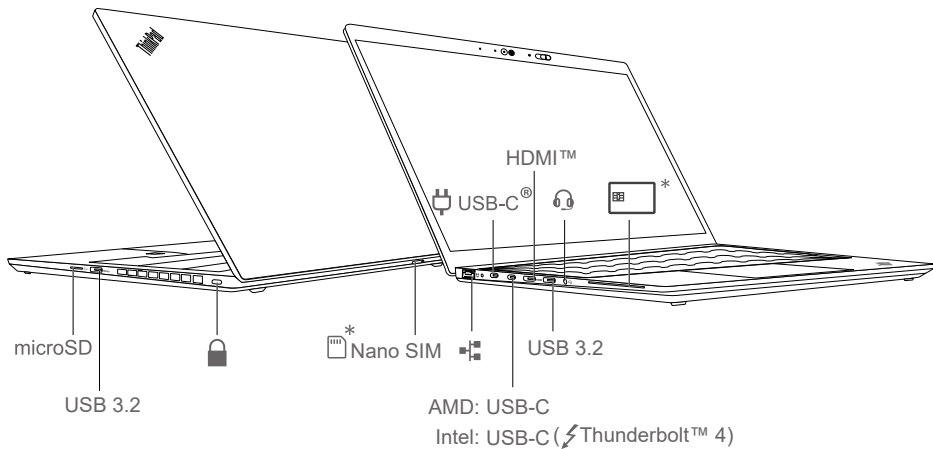

Read the statement on USB transfer rate in the User Guide. To access the User Guide, go to <https://pcsupport.lenovo.com>.

## Lenovo Commercial Vantage\*

Access Commercial Vantage to adjust device settings and check for system updates.

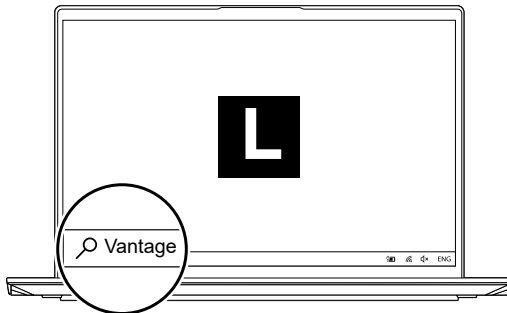

## Lenovo View

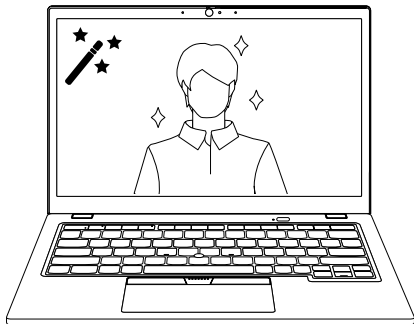

Enable Video Enhancer in Lenovo View to improve your camera quality.

[English]

## European Union (EU) / United Kingdom (UK) — radio frequency and power

This radio equipment operates with the following frequency bands and maximum radio-frequency power:

Technology	Frequency [MHz] / band	Maximum transmit power
WLAN 802.11b/g/n/ax	2400 - 2483.5	< 20 dBm
WLAN 802.11a/n/ac/ax	5150 - 5725	< 23 dBm
WLAN 802.11a/n/ac/ax	5725 - 5875	< 13.98 dBm
WLAN 802.11ax	5945 - 6425	< 23 dBm

Technology	Frequency [MHz] / band	Maximum transmit power
Bluetooth BR/EDR/LE	2400 - 2483.5	< 20 dBm
WWAN UMTS	1/8	< 25.5 dBm
WWAN LTE	1/3/7/8/20/28/34/38/40/41/42/43	< 25.5 dBm
WWAN LTE HPUE	41	< 27 dBm
NFC	13.56	< -5.31 dBμA/m@10m

Note: Not all wireless bands may be enabled depending on your product configuration. Usage of this device is limited to indoor locations in the bands 5150 - 5350 MHz and 5945 - 6425 MHz.

For Laserode Position Only

PN: xxxxxxxxx Printed in China

First Edition (March 2023)

© Copyright Lenovo 2023.

LIMITED AND RESTRICTED RIGHTS NOTICE: If data or software is delivered pursuant to a General Services Administration "GSA" contract, use, reproduction, or disclosure is subject to restrictions set forth in Contract No. GS-35F-05925.

LENOVO, LENOVO logo, THINKPAD, and THINKPAD logo are trademarks of Lenovo. Intel and Thunderbolt are trademarks of Intel Corporation or its subsidiaries in the U.S. and/or other countries. The terms HDMI and HDMI High-Definition Multimedia Interface are trademarks or registered trademarks of HDMI Licensing LLC in the United States and other countries. USB-C is a registered trademark of USB Implementers Forum. All other trademarks are the property of their respective owners.



Reduce  
Reuse  
Recycle

For FSC Mix logo only