

XPS 13 Plus 9320 / XPS 9320

Service Manual



Notes, cautions, and warnings

 **NOTE:** A NOTE indicates important information that helps you make better use of your product.

 **CAUTION:** A CAUTION indicates either potential damage to hardware or loss of data and tells you how to avoid the problem.

 **WARNING:** A WARNING indicates a potential for property damage, personal injury, or death.











Chapter 1: Working inside your computer	5
Safety instructions	5
Before working inside your computer	5
Safety precautions	6
Electrostatic discharge—ESD protection	6
ESD field service kit	7
Transporting sensitive components	8
After working inside your computer	8
Chapter 2: Removing and installing components	9
Recommended tools	9
Screw list	9
Major components of XPS 13 Plus 9320	10
Base cover	12
Removing the base cover	12
Installing the base cover	14
Battery	15
Lithium-ion battery precautions	15
Removing the battery	16
Installing the battery	18
Solid-state drive	21
Removing the M.2 2230 solid-state drive	21
Installing the M.2 2230 solid-state drive	22
Removing the M.2 2280 solid-state drive	23
Installing the M.2 2280 solid-state drive	24
Fans	25
Removing the fans	25
Installing the fans	27
Heat sink	28
Removing the heat sink	28
Installing the heat sink	29
Display assembly	29
Removing the display assembly	29
Installing the display assembly	31
System board	33
Removing the system board	33
Installing the system board	36
Power button with fingerprint reader	39
Removing the power button with fingerprint reader	39
Installing the power button with fingerprint reader	40
Keyboard	41
Removing the keyboard	41
Installing the keyboard	42
Palm-rest assembly	44

Removing the palm-rest assembly.....	44
Installing the palm-rest assembly.....	45
Chapter 3: Drivers and downloads.....	47
Chapter 4: System setup.....	48
Entering BIOS setup program.....	48
Navigation keys.....	48
Boot Sequence.....	48
One time boot menu.....	49
System setup options.....	49
System and setup password.....	61
Assigning a system setup password.....	61
Deleting or changing an existing system setup password.....	61
Clearing BIOS (System Setup) and System passwords.....	62
Updating the BIOS.....	62
Updating the BIOS in Windows.....	62
Updating the BIOS using the USB drive in Windows.....	62
Updating the BIOS from the F12 One-Time boot menu.....	63
Chapter 5: Troubleshooting.....	64
Handling swollen Lithium-ion batteries.....	64
Locate the Service Tag or Express Service Code of your Dell computer	64
System diagnostic lights.....	65
SupportAssist diagnostics.....	65
Built-in self-test (BIST).....	66
System board built-in self-test (M-BIST).....	66
Display panel power rail built-in self-test (L-BIST).....	66
Display panel built-in self-test (LCD-BIST).....	67
Outcome.....	67
Recovering the operating system.....	68
WiFi power cycle.....	68
Drain residual flea power (perform hard reset).....	68
Backup media and recovery options.....	69
Real Time Clock—RTC reset.....	69
Chapter 6: Getting help and contacting Dell.....	70

Working inside your computer



Safety instructions

Use the following safety guidelines to protect your computer from potential damage and to ensure your personal safety. Unless otherwise noted, each procedure included in this document assumes that you have read the safety information that shipped with your computer.

-  **WARNING:** Before working inside your computer, read the safety information that is shipped with your computer. For more safety best practices, see the Regulatory Compliance home page at www.dell.com/regulatory_compliance.
-  **WARNING:** Disconnect your computer from all power sources before opening the computer cover or panels. After you finish working inside the computer, replace all covers, panels, and screws before connecting your computer to an electrical outlet.
-  **CAUTION:** To avoid damaging the computer, ensure that the work surface is flat, dry, and clean.
-  **CAUTION:** To avoid damaging the components and cards, handle them by their edges, and avoid touching the pins and the contacts.
-  **CAUTION:** You should only perform troubleshooting and repairs as authorized or directed by the Dell technical assistance team. Damage due to servicing that is not authorized by Dell is not covered by your warranty. See the safety instructions that is shipped with the product or at www.dell.com/regulatory_compliance.
-  **CAUTION:** Before touching anything inside your computer, ground yourself by touching an unpainted metal surface, such as the metal at the back of the computer. While you work, periodically touch an unpainted metal surface to dissipate static electricity which could harm internal components.
-  **CAUTION:** When you disconnect a cable, pull it by its connector or its pull tab, not the cable itself. Some cables have connectors with locking tabs or thumbscrews that you must disengage before disconnecting the cable. When disconnecting cables, keep them evenly aligned to avoid bending the connector pins. When connecting cables, ensure that the ports and the connectors are correctly oriented and aligned.
-  **CAUTION:** Press and eject any installed card from the media-card reader.
-  **CAUTION:** Exercise caution when handling Lithium-ion batteries in laptops. Swollen batteries should not be used and should be replaced and disposed properly.
-  **NOTE:** The color of your computer and certain components may appear differently than shown in this document.

Before working inside your computer

Steps

1. Save and close all open files and exit all open applications.
2. Shut down your computer. For Windows operating system, click **Start** >  **Power** > **Shut down**.
 -  **NOTE:** If you are using a different operating system, see the documentation of your operating system for shut-down instructions.
3. Disconnect your computer and all attached devices from their electrical outlets.
4. Disconnect all attached network devices and peripherals, such as keyboard, mouse, and monitor from your computer.

5. Remove any media card and optical disk from your computer, if applicable.
6. Enter the service mode, if you are able to power on your computer.

Service Mode

Service Mode is used to cut-off power, without disconnecting battery cable from system board prior conducting repairs in the computer.

CAUTION: If you are unable to turn on the computer to put it into Service Mode or the computer does not support Service Mode then proceed to disconnect the battery cable. To disconnect the battery cable, follow the steps in [Removing the battery](#).

NOTE: Ensure that your computer is shut down and the AC adapter is disconnected.

- a. Hold **** key on the keyboard and press the power button for 3 seconds or until the Dell logo appears on the screen.
- b. Press any key to continue.
- c. If the AC adapter is not disconnected, a message prompting you to remove the AC adapter appears on the screen. Remove the AC adapter and then press any key to continue the **Service Mode** procedure. The **Service Mode** procedure automatically skips the following step if the **Owner Tag** of the computer is not set up in advance by the user.
- d. When the ready-to-proceed message appears on the screen, press any key to proceed. The computer emits three short beeps and shuts down immediately.
- e. Once the computer shuts down, it has successfully entered Service Mode.

NOTE: If you are unable to power on your computer or unable to enter service mode skip this process.

Safety precautions

The safety precautions chapter details the primary steps to be taken before performing any disassembly instructions.

Observe the following safety precautions before you perform any installation or break/fix procedures involving disassembly or reassembly:

- Turn off the system and all attached peripherals.
- Disconnect the system and all attached peripherals from AC power.
- Disconnect all network cables, telephone, and telecommunications lines from the system.
- Use an ESD field service kit when working inside any to avoid electrostatic discharge (ESD) damage.
- After removing any system component, carefully place the removed component on an anti-static mat.
- Wear shoes with non-conductive rubber soles to reduce the chance of getting electrocuted.

Standby power

Dell products with standby power must be unplugged before you open the case. Systems that incorporate standby power are essentially powered while turned off. The internal power enables the system to be remotely turned on (wake on LAN) and suspended into a sleep mode and has other advanced power management features.

Unplugging, pressing and holding the power button for 15 seconds should discharge residual power in the system board.

Bonding

Bonding is a method for connecting two or more grounding conductors to the same electrical potential. This is done through the use of a field service electrostatic discharge (ESD) kit. When connecting a bonding wire, ensure that it is connected to bare metal and never to a painted or non-metal surface. The wrist strap should be secure and in full contact with your skin, and ensure that you remove all jewelry such as watches, bracelets, or rings prior to bonding yourself and the equipment.

Electrostatic discharge—ESD protection

ESD is a major concern when you handle electronic components, especially sensitive components such as expansion cards, processors, memory DIMMs, and system boards. Very slight charges can damage circuits in ways that may not be obvious, such as intermittent problems or a shortened product life span. As the industry pushes for lower power requirements and increased density, ESD protection is an increasing concern.

Due to the increased density of semiconductors used in recent Dell products, the sensitivity to static damage is now higher than in previous Dell products. For this reason, some previously approved methods of handling parts are no longer applicable.

Two recognized types of ESD damage are catastrophic and intermittent failures.

- **Catastrophic** – Catastrophic failures represent approximately 20 percent of ESD-related failures. The damage causes an immediate and complete loss of device functionality. An example of catastrophic failure is a memory DIMM that has received a static shock and immediately generates a "No POST/No Video" symptom with a beep code emitted for missing or nonfunctional memory.
- **Intermittent** – Intermittent failures represent approximately 80 percent of ESD-related failures. The high rate of intermittent failures means that most of the time when damage occurs, it is not immediately recognizable. The DIMM receives a static shock, but the tracing is merely weakened and does not immediately produce outward symptoms related to the damage. The weakened trace may take weeks or months to melt, and in the meantime may cause degradation of memory integrity, intermittent memory errors, etc.

The more difficult type of damage to recognize and troubleshoot is the intermittent (also called latent or "walking wounded") failure.

Perform the following steps to prevent ESD damage:

- Use a wired ESD wrist strap that is properly grounded. The use of wireless anti-static straps is no longer allowed; they do not provide adequate protection. Touching the chassis before handling parts does not ensure adequate ESD protection on parts with increased sensitivity to ESD damage.
- Handle all static-sensitive components in a static-safe area. If possible, use anti-static floor pads and workbench pads.
- When unpacking a static-sensitive component from its shipping carton, do not remove the component from the anti-static packing material until you are ready to install the component. Before unwrapping the anti-static packaging, ensure that you discharge static electricity from your body.
- Before transporting a static-sensitive component, place it in an anti-static container or packaging.

ESD field service kit

The unmonitored Field Service kit is the most commonly used service kit. Each Field Service kit includes three main components: anti-static mat, wrist strap, and bonding wire.

Components of an ESD field service kit

The components of an ESD field service kit are:

- **Anti-Static Mat** – The anti-static mat is dissipative and parts can be placed on it during service procedures. When using an anti-static mat, your wrist strap should be snug and the bonding wire should be connected to the mat and to any bare metal on the system being worked on. Once deployed properly, service parts can be removed from the ESD bag and placed directly on the mat. ESD-sensitive items are safe in your hand, on the ESD mat, in the system, or inside a bag.
- **Wrist Strap and Bonding Wire** – The wrist strap and bonding wire can be either directly connected between your wrist and bare metal on the hardware if the ESD mat is not required, or connected to the anti-static mat to protect hardware that is temporarily placed on the mat. The physical connection of the wrist strap and bonding wire between your skin, the ESD mat, and the hardware is known as bonding. Use only Field Service kits with a wrist strap, mat, and bonding wire. Never use wireless wrist straps. Always be aware that the internal wires of a wrist strap are prone to damage from normal wear and tear, and must be checked regularly with a wrist strap tester in order to avoid accidental ESD hardware damage. It is recommended to test the wrist strap and bonding wire at least once per week.
- **ESD Wrist Strap Tester** – The wires inside of an ESD strap are prone to damage over time. When using an unmonitored kit, it is a best practice to regularly test the strap prior to each service call, and at a minimum, test once per week. A wrist strap tester is the best method for doing this test. If you do not have your own wrist strap tester, check with your regional office to find out if they have one. To perform the test, plug the wrist-strap's bonding-wire into the tester while it is strapped to your wrist and push the button to test. A green LED is lit if the test is successful; a red LED is lit and an alarm sounds if the test fails.
- **Insulator Elements** – It is critical to keep ESD sensitive devices, such as plastic heat sink casings, away from internal parts that are insulators and often highly charged.
- **Working Environment** – Before deploying the ESD Field Service kit, assess the situation at the customer location. For example, deploying the kit for a server environment is different than for a desktop or portable environment. Servers are typically installed in a rack within a data center; desktops or portables are typically placed on office desks or cubicles. Always look for a large open flat work area that is free of clutter and large enough to deploy the ESD kit with additional space to accommodate the type of system that is being repaired. The workspace should also be free of insulators that can cause an ESD event. On the work area, insulators such as Styrofoam and other plastics should always be moved at least 12 inches or 30 centimeters away from sensitive parts before physically handling any hardware components

- **ESD Packaging** – All ESD-sensitive devices must be shipped and received in static-safe packaging. Metal, static-shielded bags are preferred. However, you should always return the damaged part using the same ESD bag and packaging that the new part arrived in. The ESD bag should be folded over and taped shut and all the same foam packing material should be used in the original box that the new part arrived in. ESD-sensitive devices should be removed from packaging only at an ESD-protected work surface, and parts should never be placed on top of the ESD bag because only the inside of the bag is shielded. Always place parts in your hand, on the ESD mat, in the system, or inside an anti-static bag.
- **Transporting Sensitive Components** – When transporting ESD sensitive components such as replacement parts or parts to be returned to Dell, it is critical to place these parts in anti-static bags for safe transport.

ESD protection summary

It is recommended that all field service technicians use the traditional wired ESD grounding wrist strap and protective anti-static mat at all times when servicing Dell products. In addition, it is critical that technicians keep sensitive parts separate from all insulator parts while performing service and that they use anti-static bags for transporting sensitive components.

Transporting sensitive components

When transporting ESD sensitive components such as replacement parts or parts to be returned to Dell, it is critical to place these parts in anti-static bags for safe transport.

After working inside your computer

About this task

 **CAUTION:** Leaving stray or loose screws inside your computer may severely damage your computer.

Steps

1. Replace all screws and ensure that no stray screws remain inside your computer.
2. Connect any external devices, peripherals, or cables you removed before working on your computer.
3. Replace any media cards, discs, or any other parts that you removed before working on your computer.
4. Connect your computer and all attached devices to their electrical outlets.
 - ① **NOTE:** To exit service mode, ensure to connect the AC adapter to the power-adapter port on your computer.
5. Press the power button to turn on the computer. Your computer will automatically return to normal functioning mode.

Removing and installing components

NOTE: The images in this document may differ from your computer depending on the configuration you ordered.

Recommended tools

The procedures in this document may require the following tools:

- Phillips screwdriver #0
- Phillips screwdriver #1
- Torx #5 (T5) screwdriver

Screw list

NOTE: When removing screws from a component, it is recommended to note the screw type, the quantity of screws, and then place them in a screw storage box. This is to ensure that the correct number of screws and correct screw type is restored when the component is replaced.

NOTE: Some computers have magnetic surfaces. Ensure that the screws are not left attached to such surfaces when replacing a component.

NOTE: Screw color may vary with the configuration ordered.

Table 1. Screw list















Component	Secured to	Screw type	Quantity	Screw image
Base cover	Palm-rest and keyboard assembly	M2x3, Torx 5	6	
Battery	Palm-rest and keyboard assembly	M1.6x2.5	6	
Solid-state drive shield	System board	M2x3	1	
Fans	System board	M1.6x2.5	4	
Heat sink	System board	M2x3 (captive)	4	
Display-assembly cable bracket	System board	M1.6x2 (captive)	3	
Display-assembly cable holder	System board	M1.6x2.5	3	
Display-assembly hinges	Palm-rest and keyboard assembly	M2.5x5	6	

Table 1. Screw list (continued)

Component	Secured to	Screw type	Quantity	Screw image
Wireless-card bracket	System board	M1.6x2.3 (captive)	1	
System board	Palm-rest and keyboard assembly	M1.6x3	4	
System board	Palm-rest and keyboard assembly	M1.6x2.3	7	
Power button with fingerprint reader	Palm-rest and keyboard assembly	M1.4x2	4	
Keyboard	Palm-rest and keyboard assembly	M1.4x1.2	17	
Keyboard	Palm-rest and keyboard assembly	M1.6x2	7	

Major components of XPS 13 Plus 9320

The following image shows the major components of XPS 13 Plus 9320.

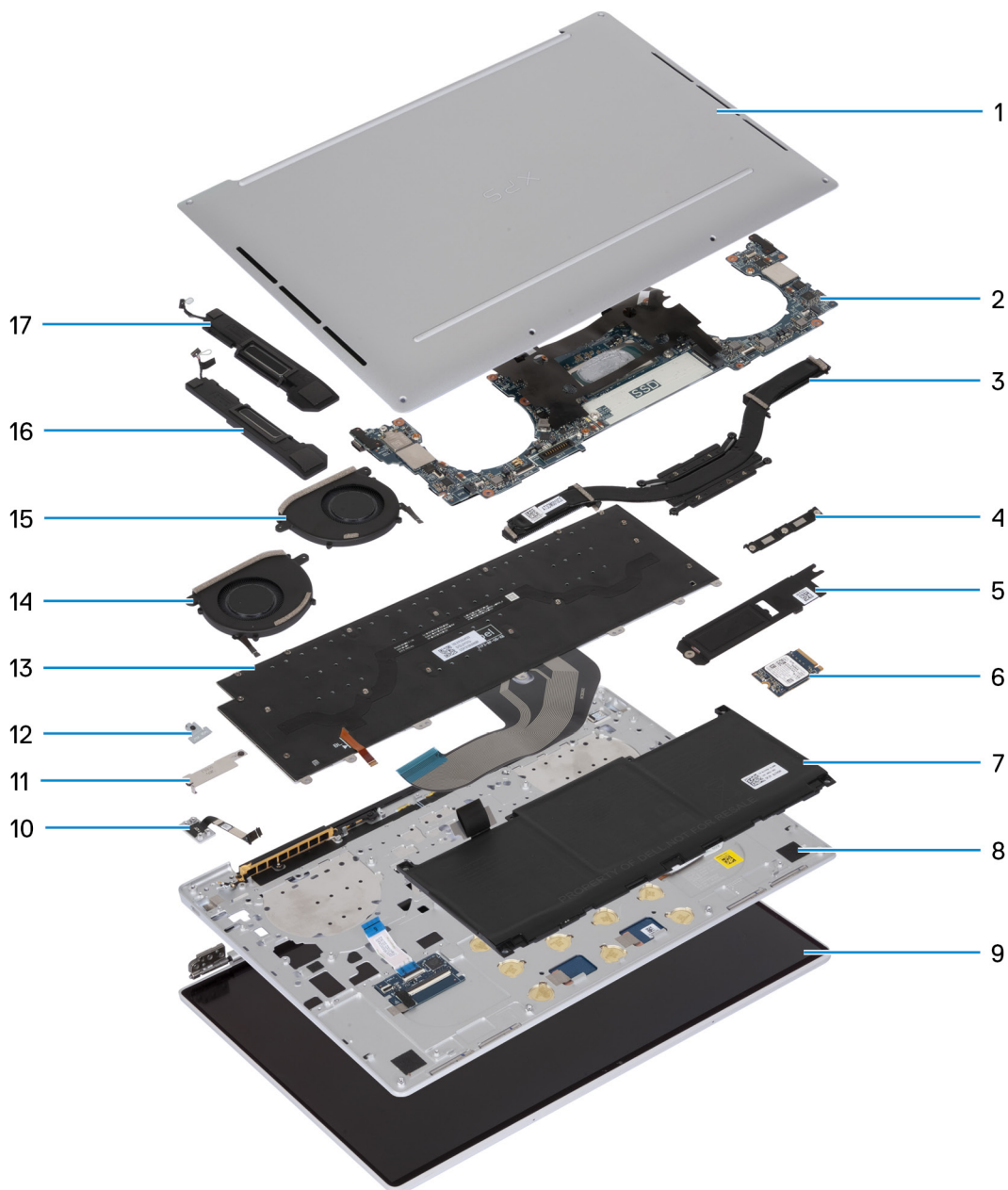

1. Base cover
2. System board
3. Heat sink
4. Display assembly-cable bracket
5. M.2 solid-state drive shield
6. Solid-state drive
7. Battery
8. Palm-rest and keyboard assembly
9. Display assembly
10. Power button
11. Battery-connector cover
12. Wireless-module bracket
13. Keyboard
14. Right fan
15. Left fan

16. Right speaker

17. Left speaker

i **NOTE:** Dell provides a list of components and their part numbers for the original system configuration purchased. These parts are available according to warranty coverages purchased by the customer. Contact your Dell sales representative for purchase options.

Base cover

Removing the base cover

Prerequisites

1. Follow the procedure in [Before working inside your computer](#).

i **NOTE:** Ensure that your computer is in Service Mode. For more information, see Step 6 in [Before working inside your computer](#).

About this task

The following image(s) indicate the location of the base cover and provides a visual representation of the removal procedure.



6x
M2x3, Torx 5





Steps

1. Remove the six screws (M2x3, Torx 5) that secure the base cover to the palm-rest and keyboard assembly.
i **NOTE:** A Torx #5 (T5) screwdriver is necessary to remove the six screws (M2x3, Torx 5).
2. Place your thumbs and fingers into the recess at the top edge of the base cover.
3. Use both thumbs to pry the base cover in order to release it from the palm-rest and keyboard assembly.

NOTE: Do not pull on or pry the base cover from where the display assembly hinges are, doing so may damage the base cover.

4. Move your hands to both sides of the base cover and lift the base cover off the palm-rest and keyboard assembly.

Installing the base cover

Prerequisites

If you are replacing a component, remove the existing component before performing the installation process.

About this task

The following image(s) indicate the location of the base cover and provides a visual representation of the installation procedure.



6x
M2x3, Torx 5





Steps

1. Place and snap the base cover into place on the palm-rest and keyboard assembly.
i **NOTE:** Align the screw holes on the base cover with the screw holes on the palm-rest and keyboard assembly before applying slight pressure to the base cover.
2. Replace the six screws (M2x3, Torx 5) that secure the base cover to the palm-rest and keyboard assembly.
i **NOTE:** A Torx #5 (T5) screwdriver is necessary to install the six screws (M2x3, Torx 5).

Next steps

1. Follow the procedure in [After working inside your computer](#).

Battery

Lithium-ion battery precautions

CAUTION:

- Exercise caution when handling Lithium-ion batteries.
- Discharge the battery completely before removing it. Disconnect the AC power adapter from the system and operate the computer solely on battery power—the battery is fully discharged when the computer no longer turns on when the power button is pressed.
- Do not crush, drop, mutilate, or penetrate the battery with foreign objects.
- Do not expose the battery to high temperatures, or disassemble battery packs and cells.
- Do not apply pressure to the surface of the battery.
- Do not bend the battery.
- Do not use tools of any kind to pry on or against the battery.

- Ensure any screws during the servicing of this product are not lost or misplaced, to prevent accidental puncture or damage to the battery and other system components.
- If the battery gets stuck inside your computer as a result of swelling, do not try to release it as puncturing, bending, or crushing a lithium-ion battery can be dangerous. In such an instance, contact Dell technical support for assistance. See www.dell.com/contactdell.
- Always purchase genuine batteries from www.dell.com or authorized Dell partners and resellers.
- Swollen batteries should not be used and should be replaced and disposed properly. For guidelines on how to handle and replace swollen Lithium-ion batteries, see [Handling swollen Lithium-ion batteries](#).

Removing the battery

Prerequisites

1. Follow the procedure in [Before working inside your computer](#).
2. Remove the [base cover](#).

About this task

The following image(s) indicate the location of the battery and provides a visual representation of the removal procedure.

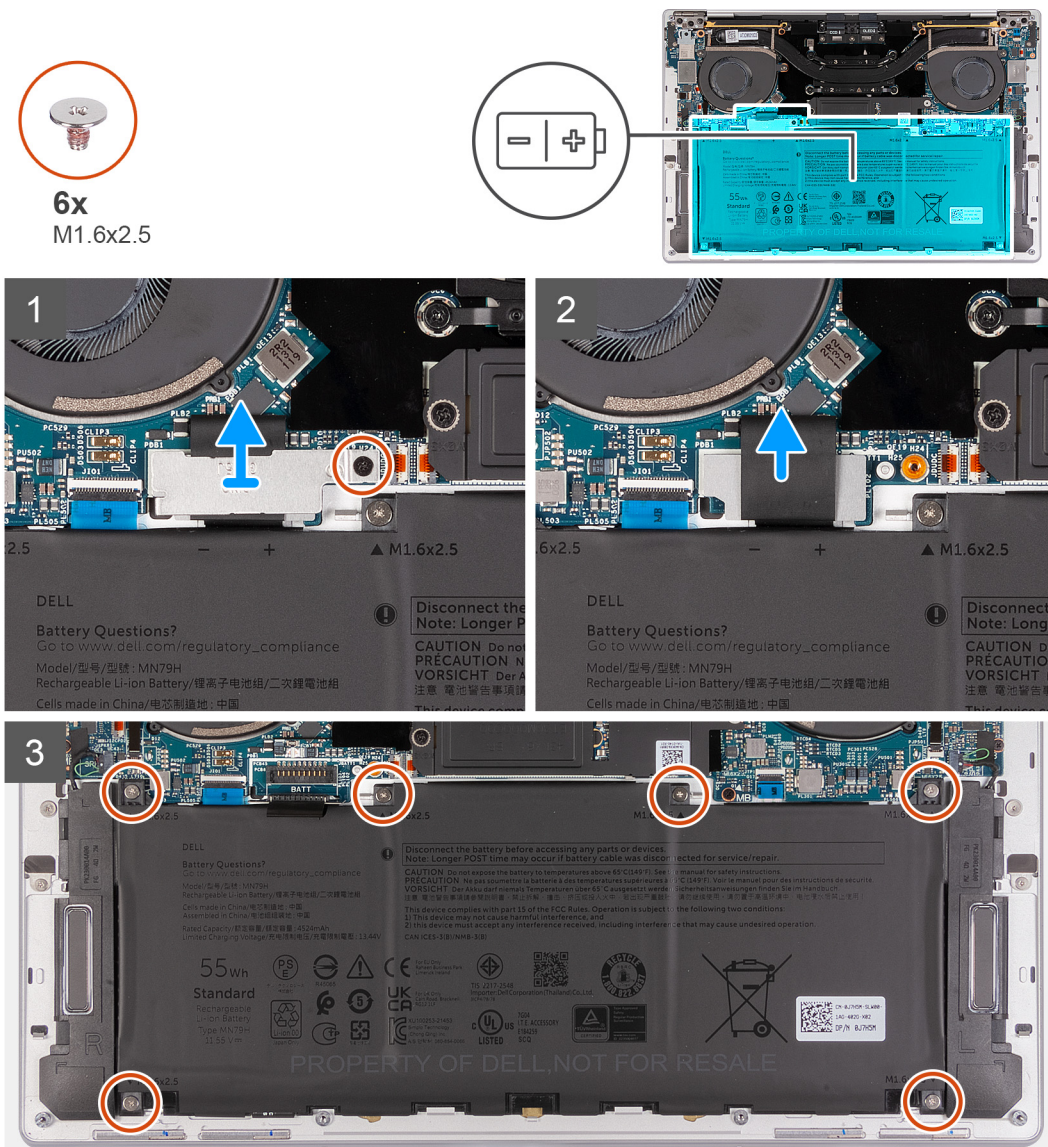

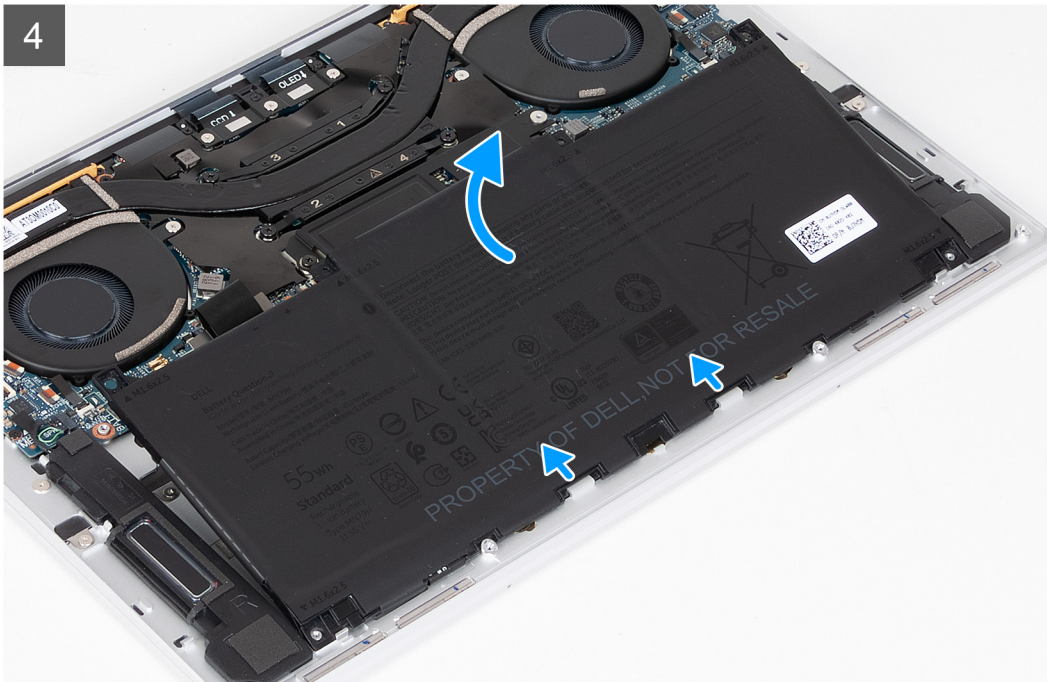

Steps

1. Loosen the captive screw that secures the battery-connector bracket to the system board.
2. Unhook and lift the battery-connector bracket off the system board.

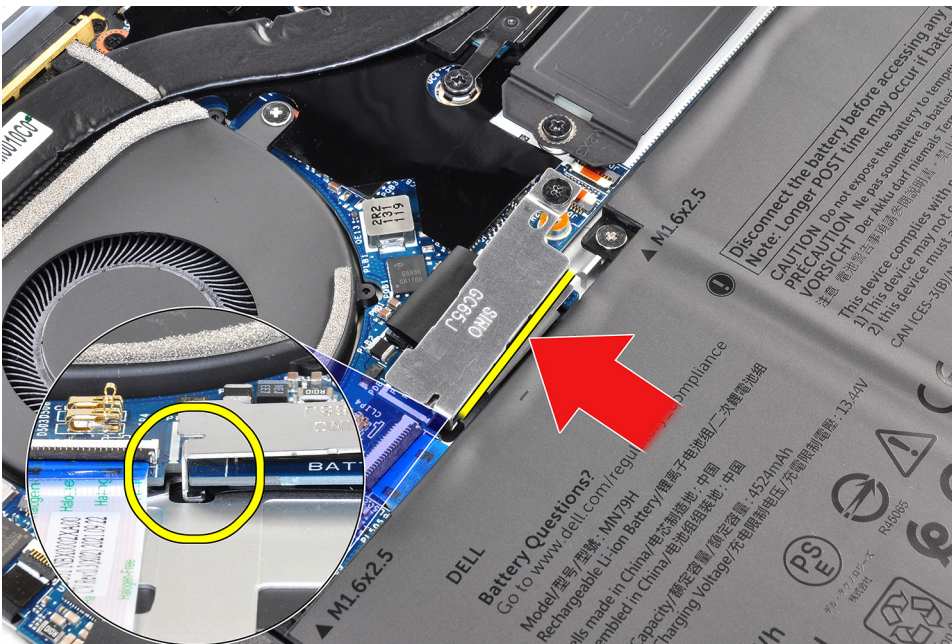

3. Use the pull tab on the battery power cable to disconnect the battery cable from the battery connector.
4. Remove the six screws (M1.6x2.5) that secure the battery to the palm-rest and keyboard assembly.
5. Use the pull tab to lift the battery slightly from its top edge. This action releases the battery from the two hooks that are located near the bottom edge of the palm-rest and keyboard assembly.

CAUTION: Do not lift the battery at more than an angle of 30 degrees to avoid damage to the battery and the palm-rest and keyboard assembly.

6. Slide the battery towards the front and lift the battery off the palm-rest and keyboard assembly.

Installing the battery

Prerequisites

If you are replacing a component, remove the existing component before performing the installation process.

About this task

The following image(s) indicate the location of the battery and provides a visual representation of the installation procedure.



6x
M1.6x2.5

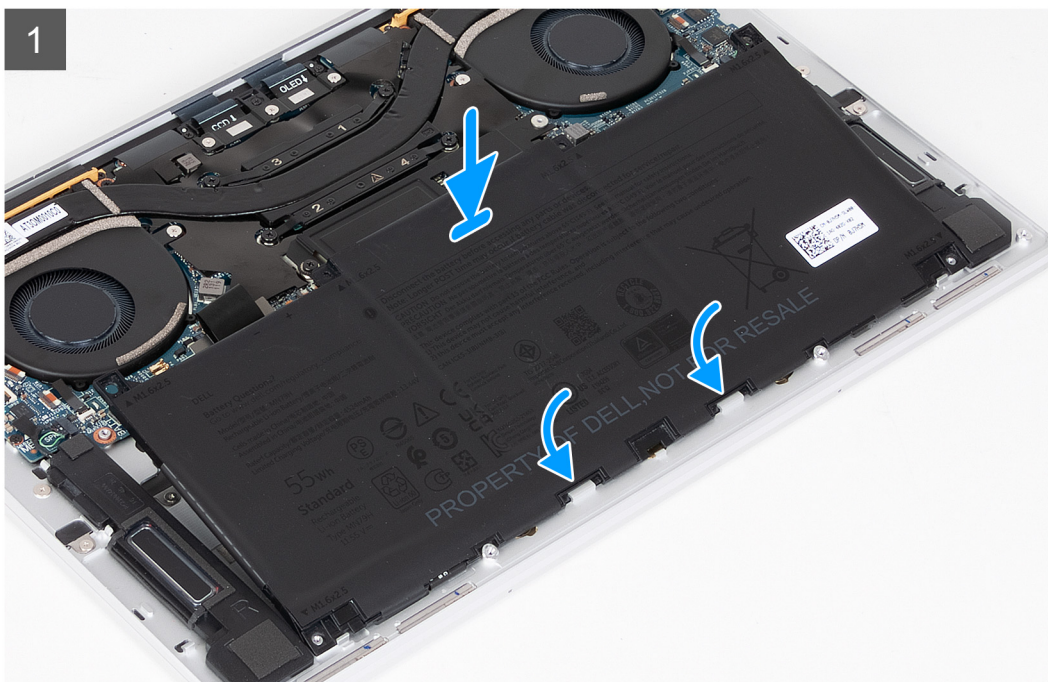
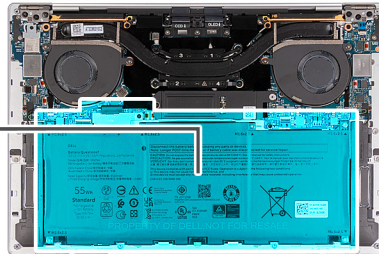
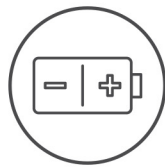

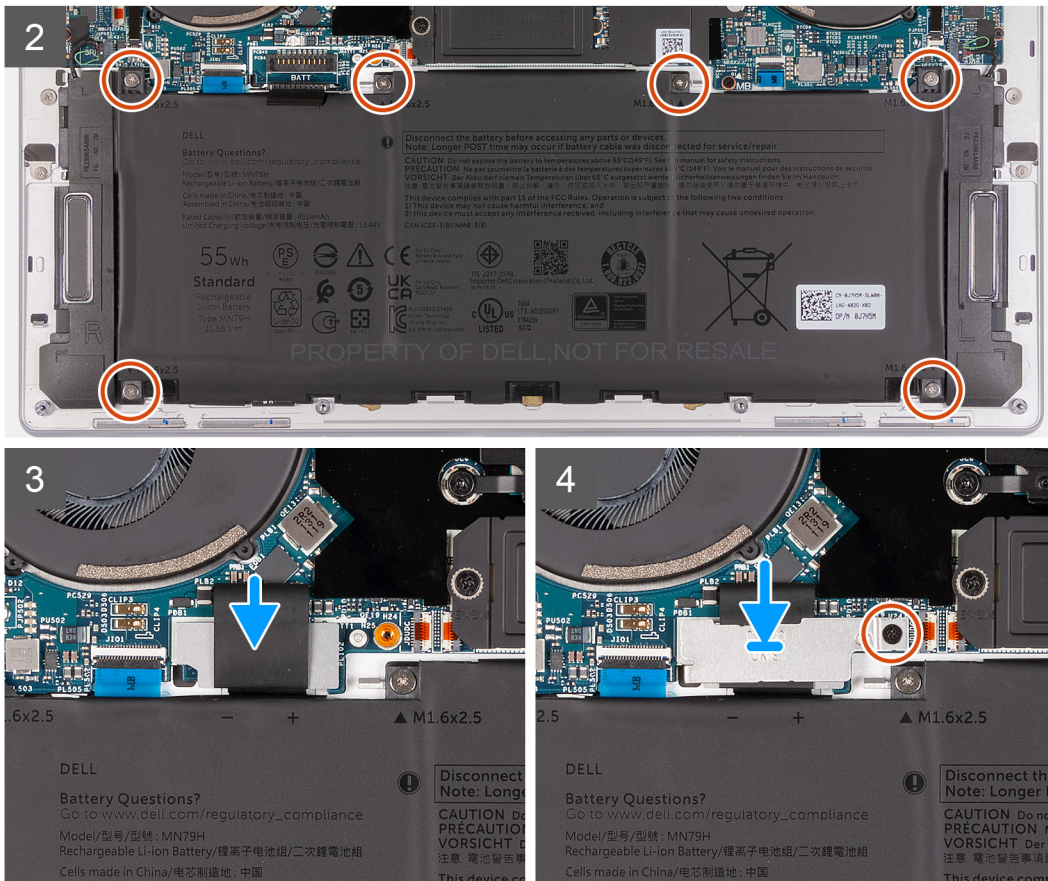

Steps

1. Align the edge of the battery at an angle so that the cutouts on the battery fit into the hooks on the palm-rest and keyboard assembly. Align the two screw holes on the battery with the screw holes on the palm-rest and keyboard assembly as well.

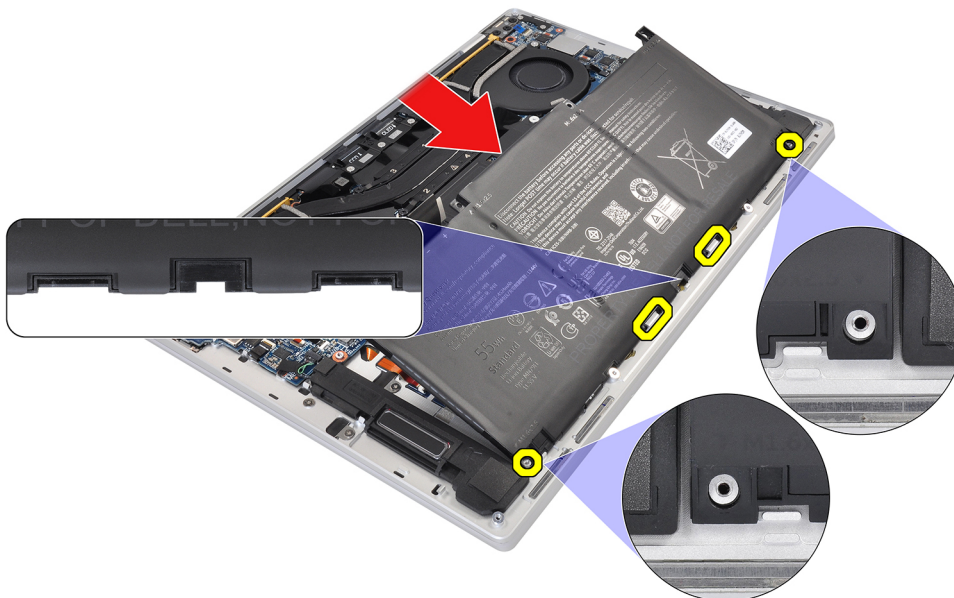

2. Lower the battery to the palm-rest and keyboard assembly until it fits into the battery section of the palm-rest and keyboard assembly.
3. Replace the six screws (M1.6x2.5) that secure the battery to the palm-rest and keyboard assembly.

NOTE: Align the screw holes on the base cover with the screw holes on the palm-rest and keyboard assembly before replacing the screws.

4. Connect the battery cable to the system board.
5. Line up the battery-connector bracket over the battery connector on the system board.

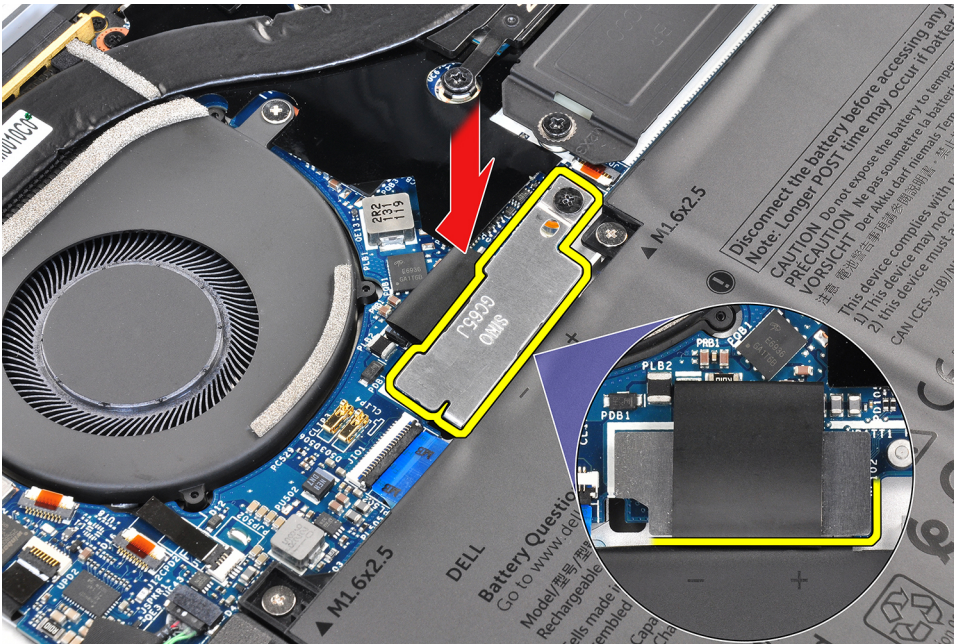

6. Slide the hook at the end of the battery-connector bracket under the system board. Ensure the hook fits into the underside of the system board.

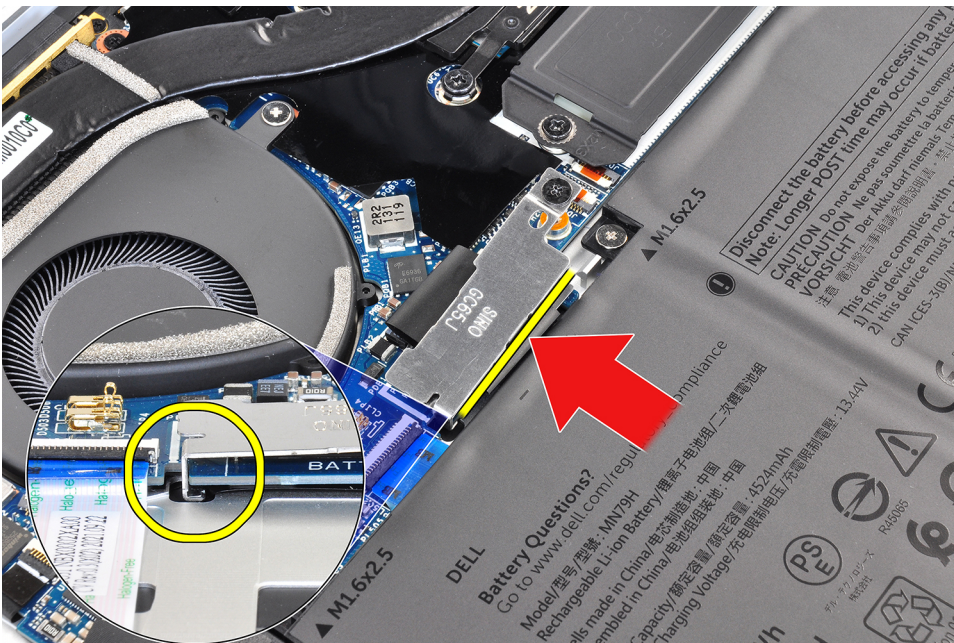

7. Tighten the captive screw on the bracket to the system board and ensure stud on the system board fits into its opening on the battery-connector bracket.

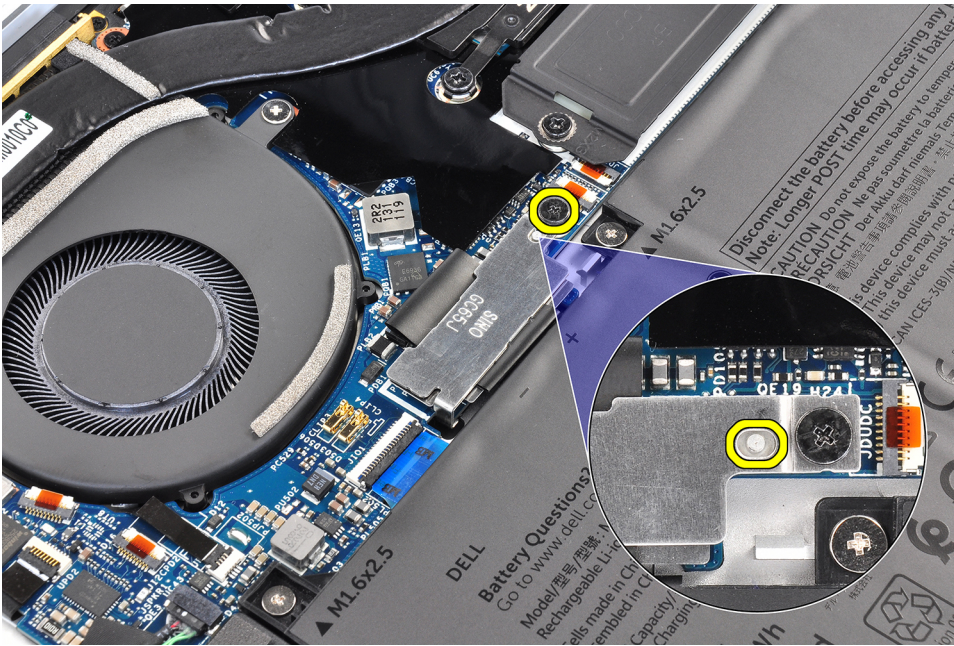

Next steps

1. Install the [base cover](#).
2. Follow the procedure in [After working inside your computer](#).

Solid-state drive

Removing the M.2 2230 solid-state drive

Prerequisites

1. Follow the procedure in [Before working inside your computer](#).
2. Remove the [base cover](#).

About this task

NOTE: Depending on the configuration ordered, your computer may support an M.2 2230 solid-state drive or an M.2 2280 solid-state drive.

NOTE: This procedure applies only to computers shipped with an M.2 2230 solid-state drive.

The following image(s) indicate the location of the M.2 2230 solid-state drive and provides a visual representation of the removal procedure.



1x
M2x3

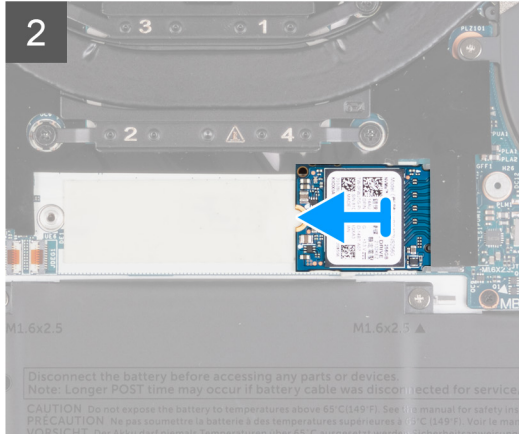
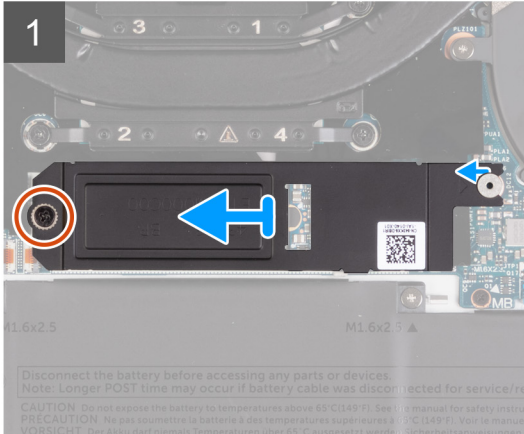
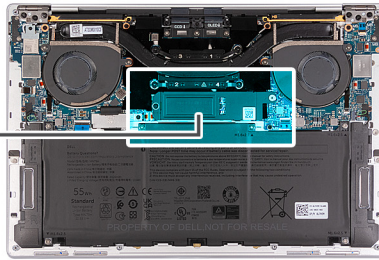

Steps

1. Remove the screw (M2x3) that secures the M.2 solid-state drive shield to the system board.
2. Slide the M.2 solid-state drive shield off the system board.
3. Slide the M.2 2230 solid-state drive out of the solid-state drive slot.

Installing the M.2 2230 solid-state drive

Prerequisites

If you are replacing a component, remove the existing component before performing the installation process.

About this task

The following image(s) indicate the location of the M.2 2230 solid-state drive and provides a visual representation of the installation procedure.



1x
M2x3

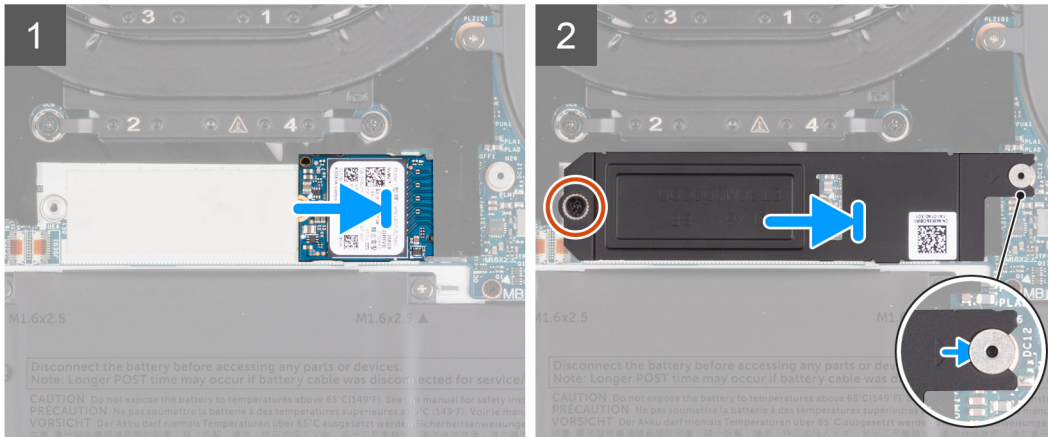
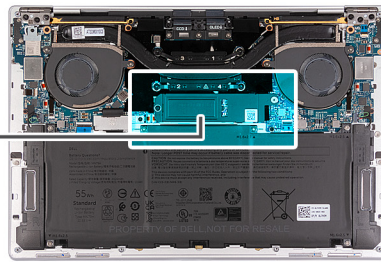

Steps

1. Align the notch on the M.2 2230 solid-state drive with the tab on the solid-state drive slot.
2. Slide the M.2 2230 solid-state drive into the solid-state drive slot.
3. Insert the tab of the M.2 solid-state drive shield into the peg on the system board.
4. Replace the screw (M2x3) that secures the M.2 solid-state drive shield to the system board.

Next steps

1. Install the [base cover](#).
2. Follow the procedure in [After working inside your computer](#).

Removing the M.2 2280 solid-state drive

Prerequisites

1. Follow the procedure in [Before working inside your computer](#).
2. Remove the [base cover](#).

About this task

NOTE: Depending on the configuration ordered, your computer may support an M.2 2230 solid-state drive or an M.2 2280 solid-state drive.

NOTE: This procedure applies only to computers shipped with an M.2 2280 solid-state drive.

The following image(s) indicate the location of the M.2 2280 solid-state drive and provides a visual representation of the removal procedure.



1x
M2x3

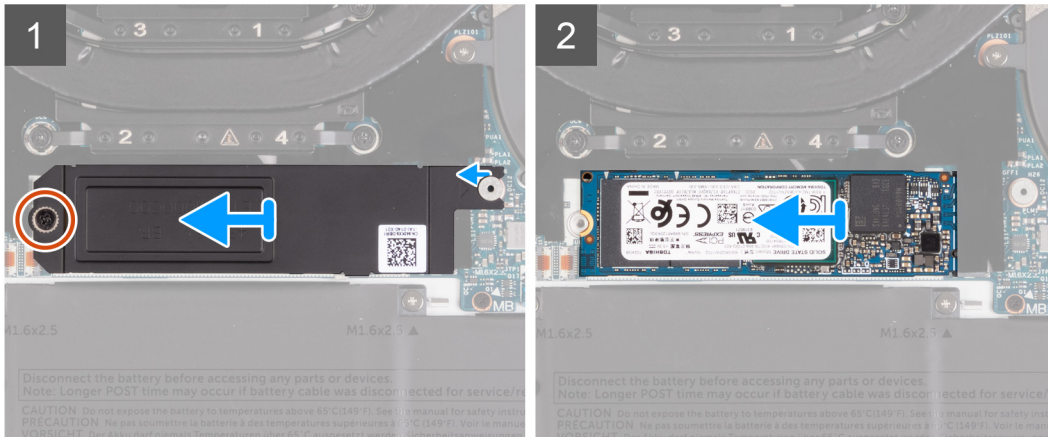
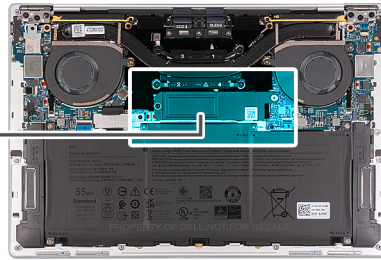

Steps

1. Loosen the screw (M2x3) that secures the M.2 solid-state drive shield to the system board.
2. Lift the M.2 solid-state drive shield off the system board.
3. Slide the M.2 2280 solid-state drive out of the solid-state drive slot.
4. Lift the M.2 2280 solid-state drive assembly off the system board.

Installing the M.2 2280 solid-state drive

Prerequisites

If you are replacing a component, remove the existing component before performing the installation process.

About this task

NOTE: Depending on the configuration ordered, your computer may support an M.2 2230 solid-state drive or an M.2 2280 solid-state drive.

NOTE: This procedure applies only to computers shipped with an M.2 2230 solid-state drive.

The following image(s) indicate the location of the M.2 2280 solid-state drive and provides a visual representation of the installation procedure.



1x
M2x3

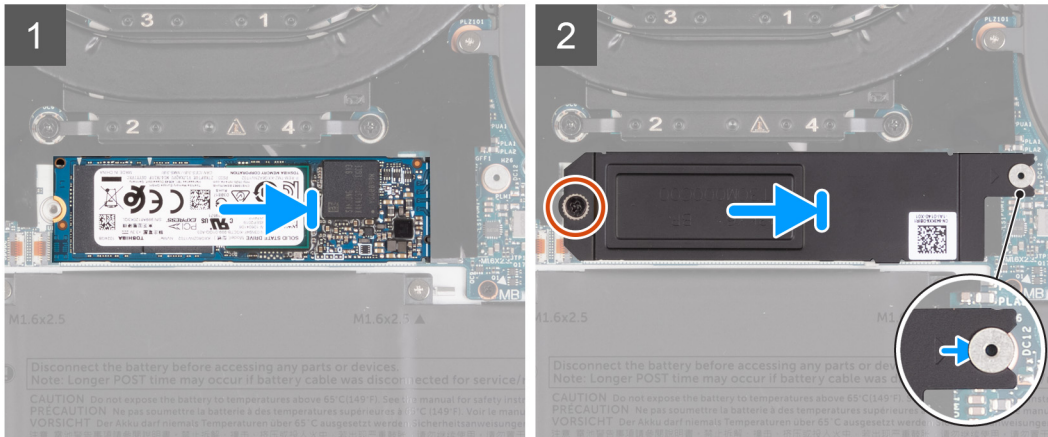
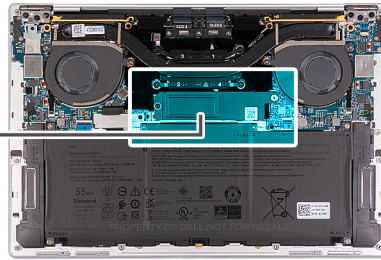

Steps

1. Align the notch on the M.2 2280 solid-state drive with the tab on the solid-state drive slot.
2. Slide the M.2 2280 solid-state drive into the solid-state drive slot.
3. Insert the tab of the M.2 solid-state drive shield into the peg on the system board.
4. Replace the screw (M2x3) that secures the M.2 solid-state drive shield to the system board.

Next steps

1. Install the [base cover](#).
2. Follow the procedure in [After working inside your computer](#).

Fans

Removing the fans

Prerequisites

1. Follow the procedure in [Before working inside your computer](#).
2. Remove the [base cover](#).

About this task

The following image(s) indicate the location of the fans and provides a visual representation of the removal procedure.



2x
M1.6x2.5

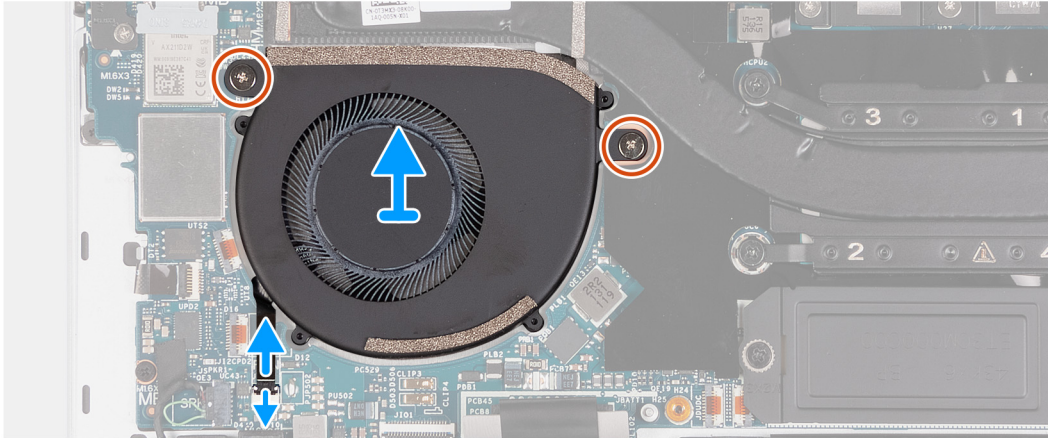
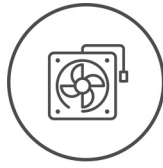

2x
M1.6x2.5

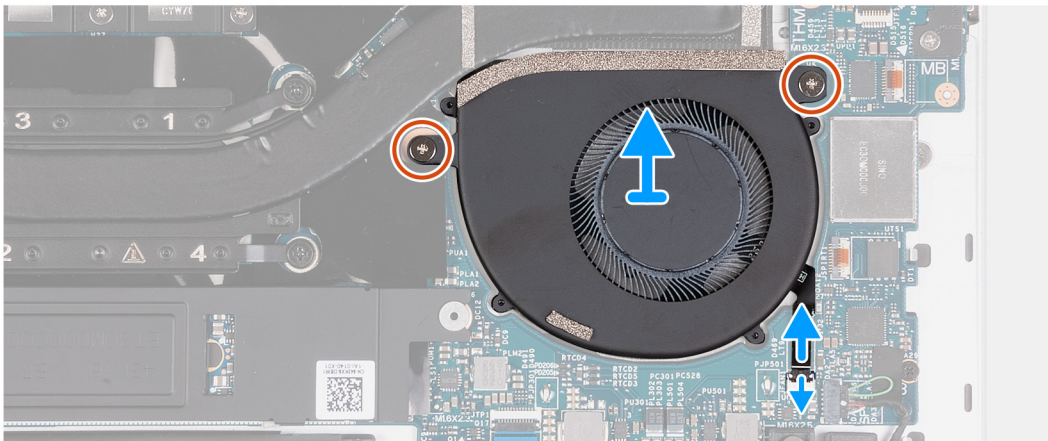
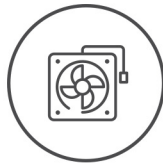

Steps

1. Lift the latch of right-fan cable connector, use the pull tab of the right-fan cable to disconnect it from the system board.
2. Remove the two screws (M1.6x2.5) that secure the right fan to the system board.
3. Lift the right fan off the system board.
4. Lift the latch of left-fan cable connector, use the pull tab of the left-fan cable to disconnect it from the system board.
5. Remove the two screws (M1.6x2.5) that secure the left fan to the system board.
6. Lift the left fan off the system board.

Installing the fans

Prerequisites

If you are replacing a component, remove the existing component before performing the installation process.

About this task

The following image(s) indicate the location of the fans and provides a visual representation of the installation procedure.

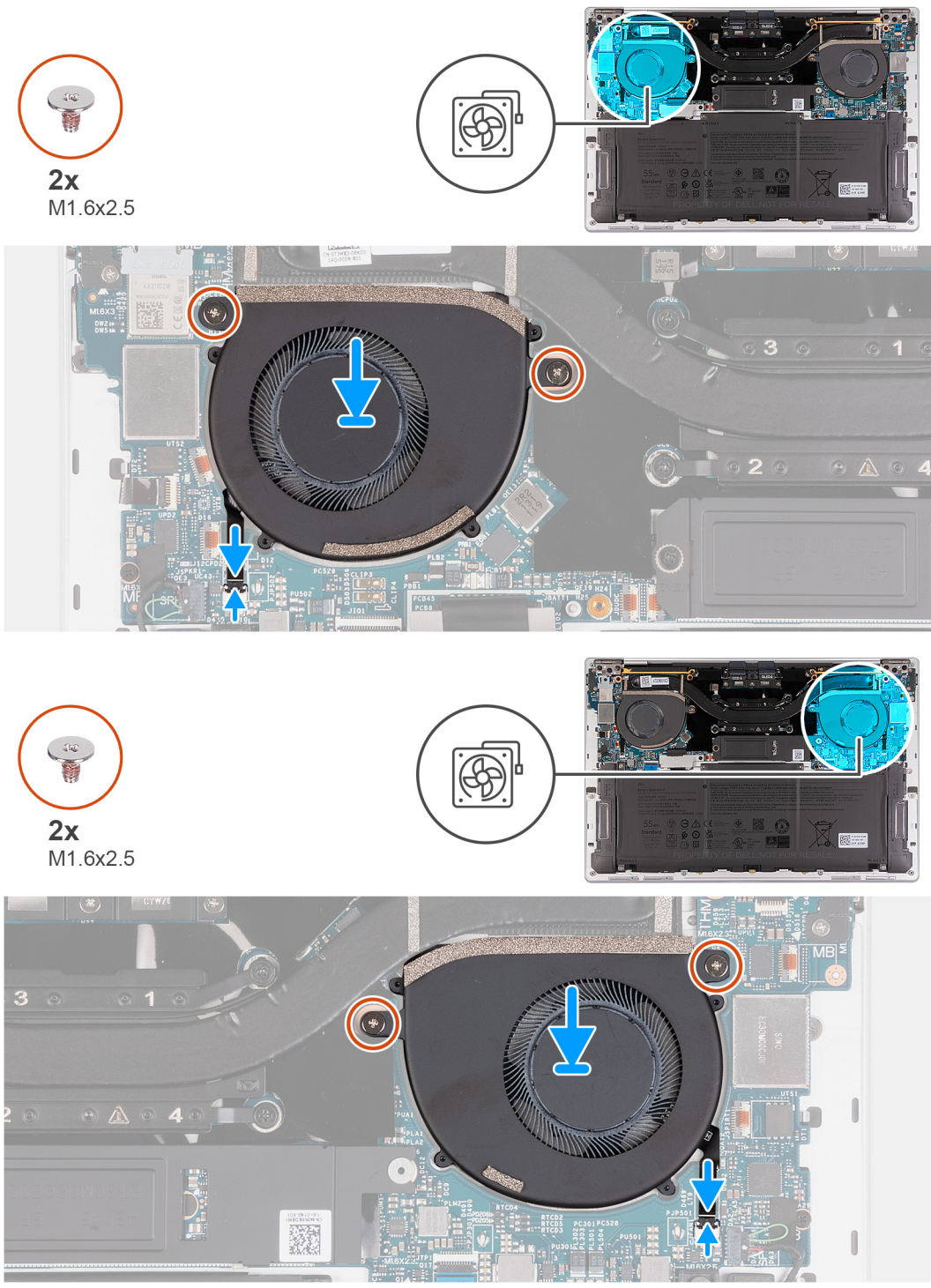

Steps

1. Align the screw holes of the right fan with the screw holes of the system board.

2. Replace the two screws (M1.6x2.5) that secure the right fan to the system board.
3. Connect the right fan cable to the system board.
4. Align the screw holes of the left fan with the screw holes of the system board.
5. Replace the two screws (M1.6x2.5) that secure the left fan to the system board.
6. Connect the left fan cable to the system board.

Next steps

1. Install the [base cover](#).
2. Follow the procedure in [After working inside your computer](#).

Heat sink

Removing the heat sink

Prerequisites

1. Follow the procedure in [Before working inside your computer](#).
2. Remove the [base cover](#).

About this task

⚠ CAUTION: The heat sink may become hot during normal operation. Allow sufficient time for the heat sink to cool before you touch it.

i NOTE: For maximum cooling of the processor, do not touch the heat transfer areas on the heat sink. The oils in your skin can reduce the heat transfer capability of the thermal grease.

The following image(s) indicate the location of the heat sink and provides a visual representation of the removal procedure.

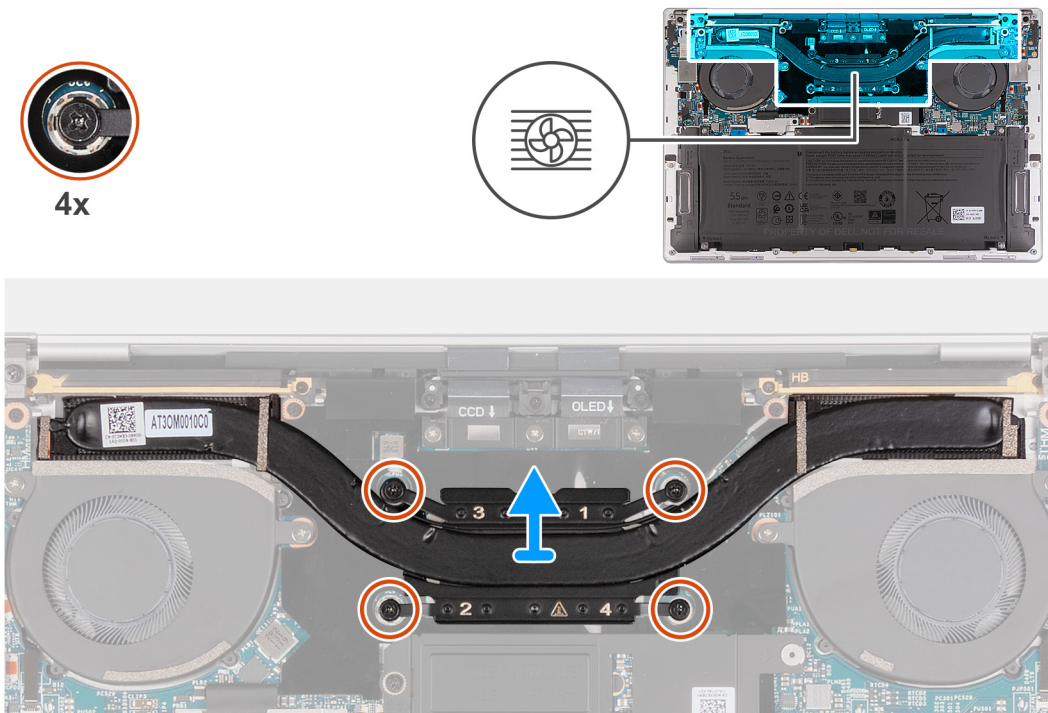

Steps

1. In reverse sequential order (4>3>2>1), loosen the four captive screws that secure the heat sink to the system board.
2. Lift the heat sink off the system board.

Installing the heat sink

Prerequisites

If you are replacing a component, remove the existing component before performing the installation process.

About this task

- NOTE:** Incorrect alignment of the heat sink can damage the system board and processor.
- NOTE:** If either the system board or the heat sink is replaced, use the thermal grease that is provided in the kit to ensure that thermal conductivity is achieved.

The following image(s) indicate the location of the heat sink and provides a visual representation of the installation procedure.

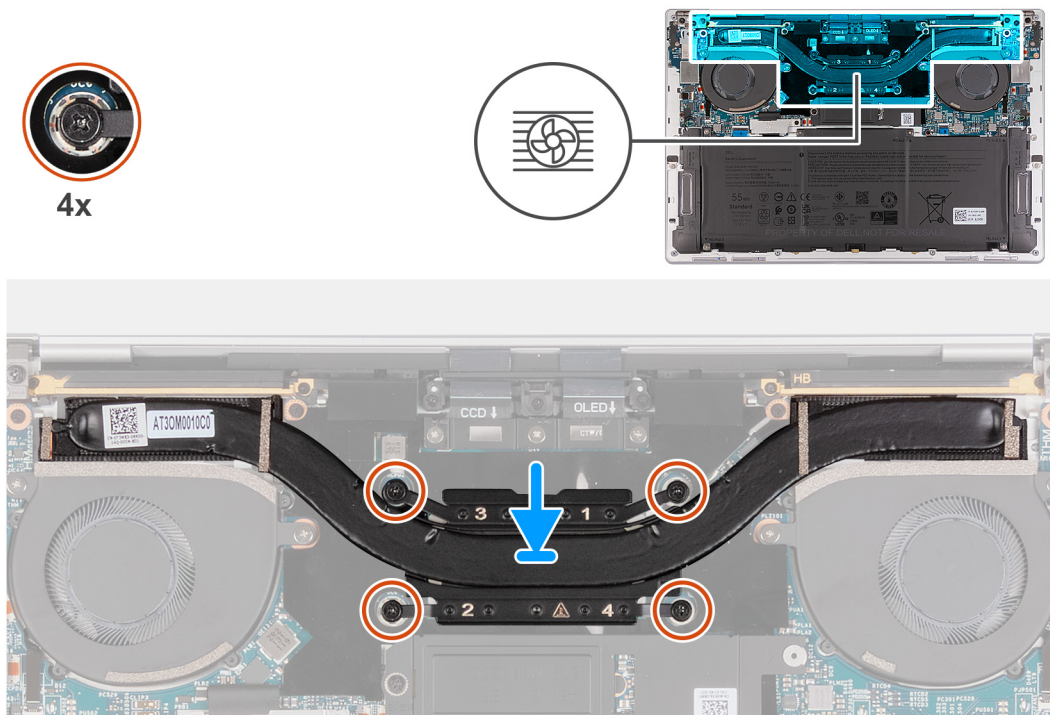

Steps

1. Align the screw holes of the heat sink with the screw holes of the system board.
2. In sequential order (1>2>3>4), tighten the four captive screws that secure the heat sink to the system board.

Next steps

1. Install the [base cover](#).
2. Follow the procedure in [After working inside your computer](#).

Display assembly

Removing the display assembly

Prerequisites

1. Follow the procedure in [Before working inside your computer](#).
2. Remove the [base cover](#).

About this task

The following image(s) indicate the location of the display assembly and provides a visual representation of the removal procedure.

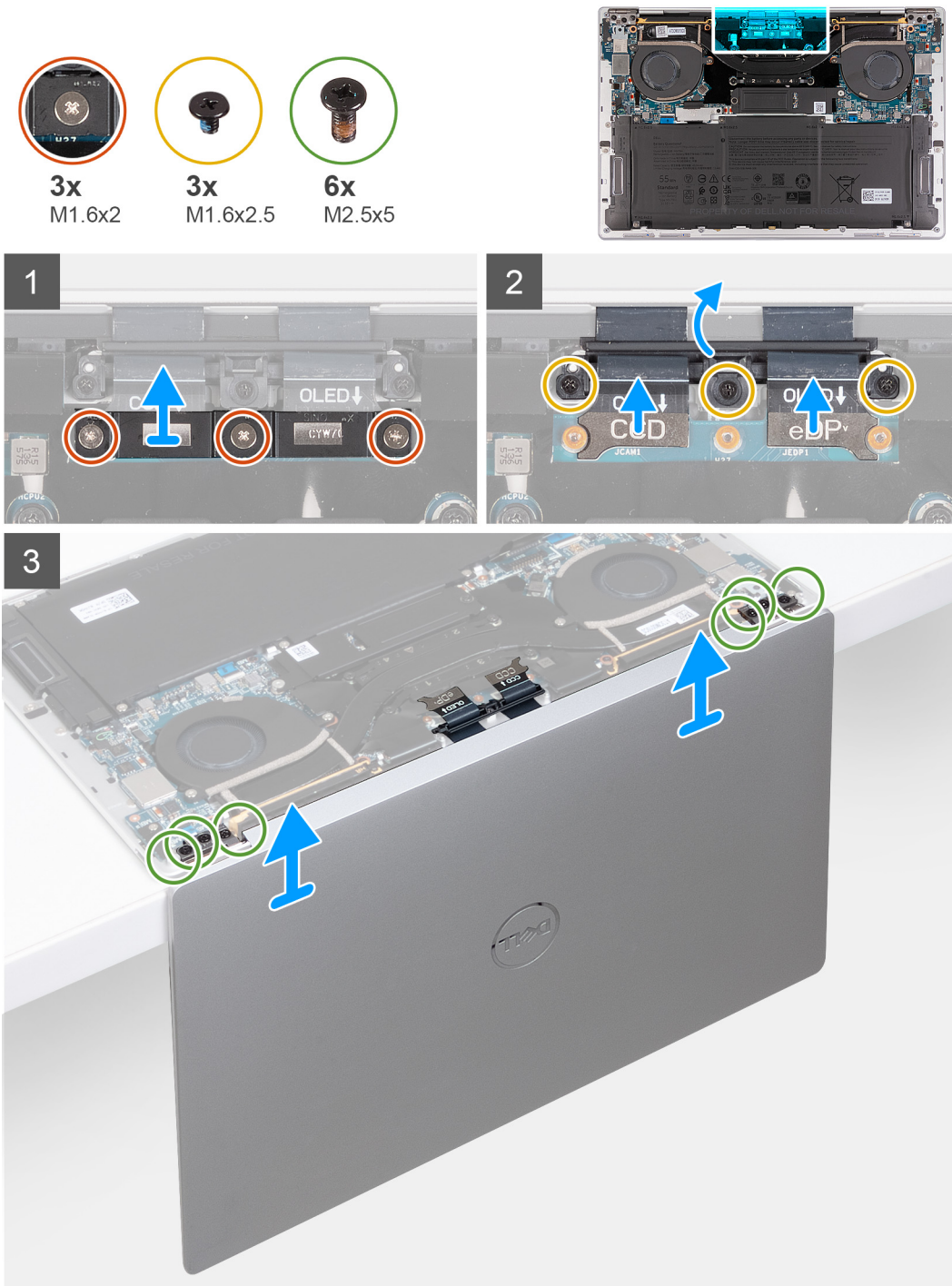

Steps

1. Loosen the three captive screws (M1.6x2) that secure the display-assembly cable bracket to the system board.
2. Lift the display-assembly cable bracket off the system board.
3. Disconnect the camera cable and the display cable from the system board.
4. Remove the three screws (M1.6x2.5) that secure the camera and display-assembly cables holder to the system board.
5. Open the display to a 90-degree angle and place the computer at the edge of a flat table.
6. Remove the three screws (M1.6x2.5) that secure the camera and display-assembly cables holder to the system board.

7. Remove the three screws (M2.5x5) that secure the left hinge to the system board and the palm-rest and keyboard assembly.
8. Remove the three screws (M2.5x5) that secure the right hinge to the system board and the palm-rest and keyboard assembly.
9. Lift the display assembly off the palm-rest and keyboard assembly.
10. After performing all the above steps, you are left with display assembly.

Installing the display assembly

Prerequisites

If you are replacing a component, remove the existing component before performing the installation process.

About this task

The following image(s) indicate the location of the display assembly and provides a visual representation of the installation procedure.



3x
M1.6x2



3x
M1.6x2.5



6x
M2.5x5

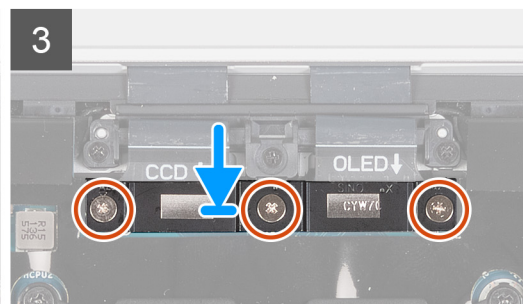
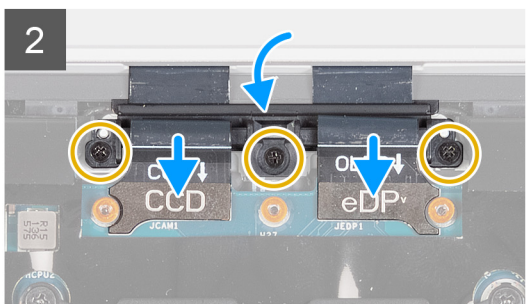
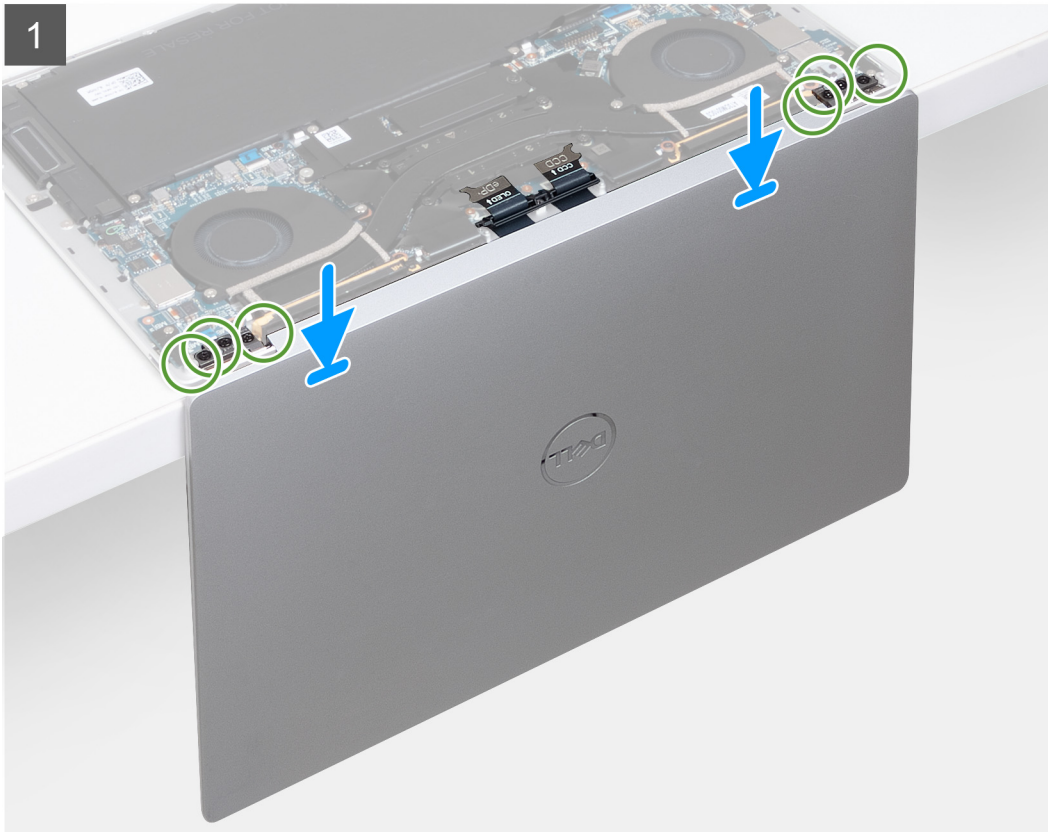

Steps

1. Open the display assembly to a 90-degree angle and place the computer on the edge of a flat surface.
2. Place the palm-rest and keyboard assembly at the edge of a flat table.
3. Open the hinges of the display assembly to a 90-degree angle.
4. Align the screw holes of the palm-rest and keyboard assembly to the screws holes on the hinges of the display assembly.
5. Replace the three screws (M2.5x5) that secure the left hinge to the palm-rest and keyboard assembly.
6. Replace the three screws (M2.5x5) that secure the right hinge to the palm-rest and keyboard assembly.
7. Close the display assembly, turn the computer over and place it on the flat surface.
8. Slide the camera and display-assembly cables holder back to the system board.
9. Replace three screws (M1.6x2.5) that secure the camera and display-assembly cables holder to the system board.
10. Connect the camera cable and the display cable to the system board.

11. Align the screw holes on the display-assembly cable bracket with the screw holes on the system board and tighten the three captive screws (M1.6x2).

Next steps

1. Install the [base cover](#).
2. Follow the procedure in [After working inside your computer](#).

System board

Removing the system board

Prerequisites

1. Follow the procedure in [Before working inside your computer](#).
2. Remove the [base cover](#).
3. Remove the [M.2 2230 solid-state drive](#) or [M.2 2280 solid-state drive](#) from M.2 slot, whichever applicable.
4. Remove the [battery](#).
5. Remove the [fans](#).
6. Remove the [heat sink](#).

About this task

The following image indicates the connectors and component(s) on your system board.

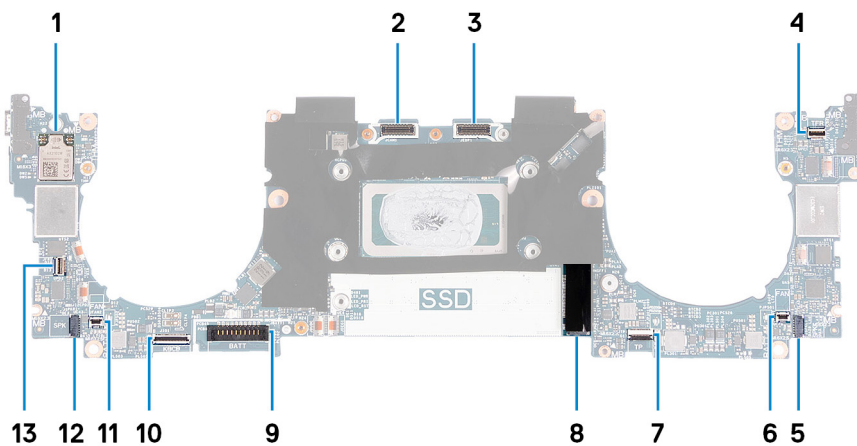

Figure 1. System-board connectors

- | | |
|---|--|
| 1. Wireless card | 2. Camera-assembly cable connector |
| 3. Display-assembly cable connector | 4. Capacitive touch-panel cable connector |
| 5. Left-speaker cable connector | 6. Left-fan cable connector |
| 7. Haptic-module cable connector | 8. M.2 solid-state drive slot |
| 9. Battery cable connector | 10. Keyboard-daughterboard cable connector |
| 11. Right-fan cable connector | 12. Right-speaker cable connector |
| 13. Power-button and fingerprint-reader cable connector | |

The following image(s) indicate the location of the system board and provides a visual representation of the removal procedure.



3x
M1.6x2



1x
M1.6x2.3



7x
M1.6x2.3



4x
M1.6x3

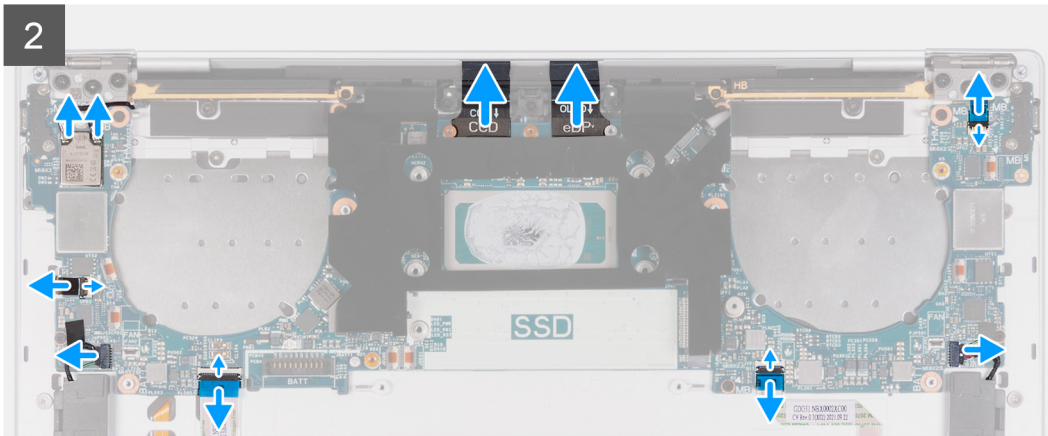
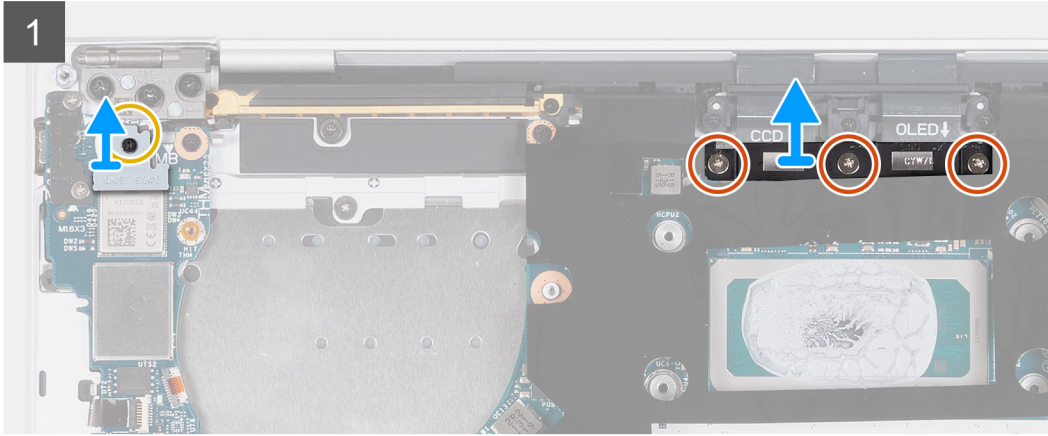
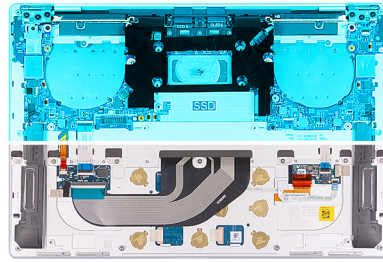

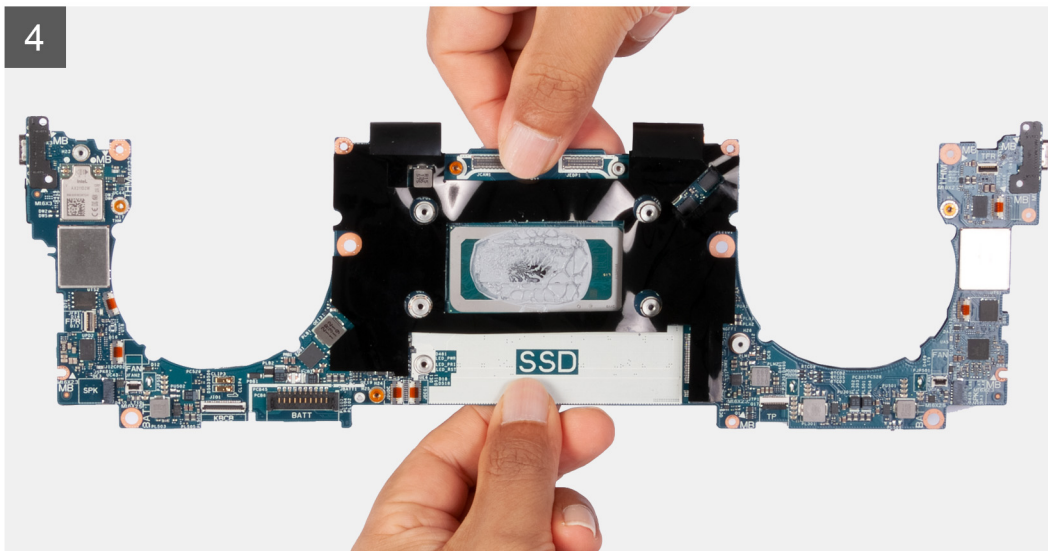
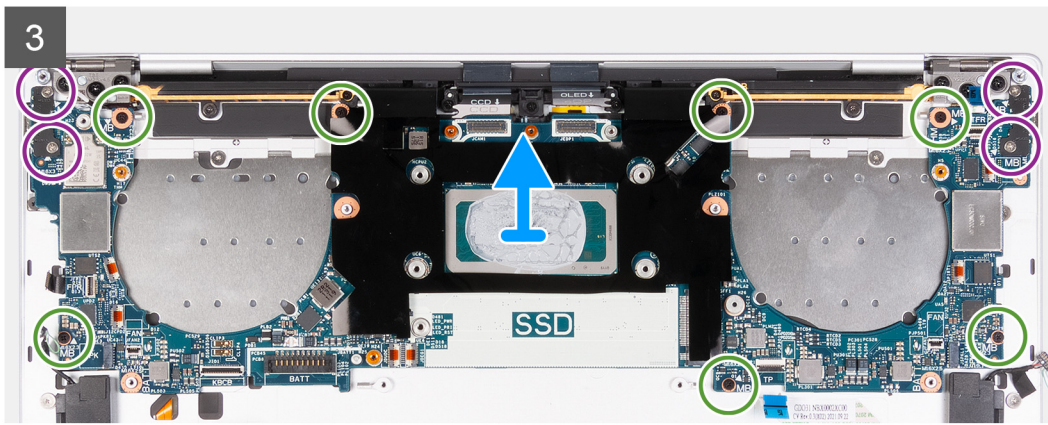

Steps

1. Loosen the captive screw (M1.6x2.3) that secures the wireless-module bracket to the system board.
2. Lift the wireless-module bracket off the system board.
3. Loosen the three captive screws (M1.6x2) that secure the display-assembly cable bracket to the system board.
4. Lift the display-assembly cable bracket off the system board.
5. Disconnect the wireless-module cables from the wireless module.
6. Disconnect the camera cable and the display cable from the system board.
7. Lift the latch of the capacitive touch-panel connector and use the pull tab of the cable to disconnect the capacitive touch-panel cable.
8. Use the pull tab to disconnect the left-speaker cable.
9. Lift the latch of the haptic-module cable connector and use the pull tab of the cable to disconnect the haptic-module cable.
10. Lift the latch of the keyboard control-board connector and use the pull tab of the cable to disconnect the keyboard control-board cable.
11. Use the pull tab to disconnect the right-speaker cable.
12. Lift the latch of the power-button connector and use the pull tab of the cable to disconnect the power-button cable.
13. Remove the four screws (M1.6x3) that secure the system board to the palm-rest and keyboard assembly.
14. Remove the seven screws (M1.6x2.3) that secure the system board to the palm-rest and keyboard assembly.
15. Hold the system board by the short edges, as shown in the image, and lift the board off the palm-rest and keyboard assembly with care.

Installing the system board

Prerequisites

If you are replacing a component, remove the existing component before performing the installation process.

About this task

The following image indicates the connectors and component(s) on your system board.

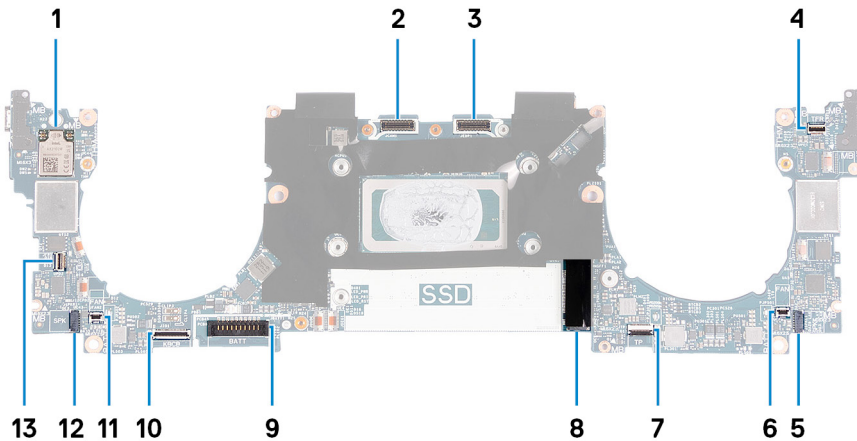

Figure 2. System-board connectors

- 1. Wireless card
- 2. Camera-assembly cable connector
- 3. Display-assembly cable connector
- 4. Capacitive touch-panel cable connector
- 5. Left-speaker cable connector
- 6. Left-fan cable connector
- 7. Haptic-module cable connector
- 8. M.2 solid-state drive slot
- 9. Battery cable connector
- 10. Keyboard-daughterboard cable connector
- 11. Right-fan cable connector
- 12. Right-speaker cable connector
- 13. Power-button and fingerprint-reader cable connector

The following image(s) indicate the location of the system board and provides a visual representation of the installation procedure.



3x
M1.6x2



1x
M1.6x2.3



7x
M1.6x2.3



4x
M1.6x3

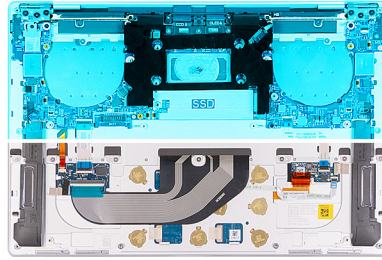

1

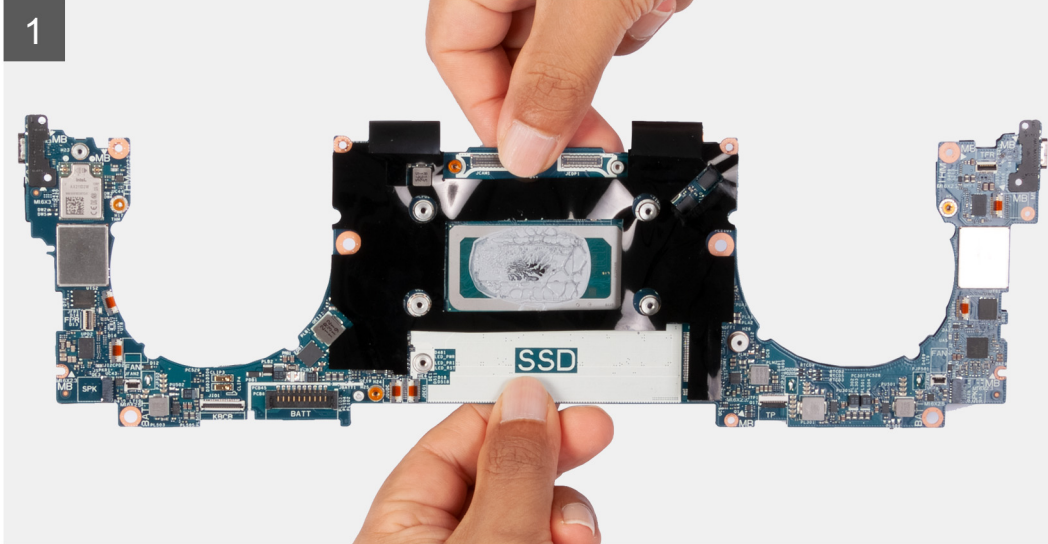

2

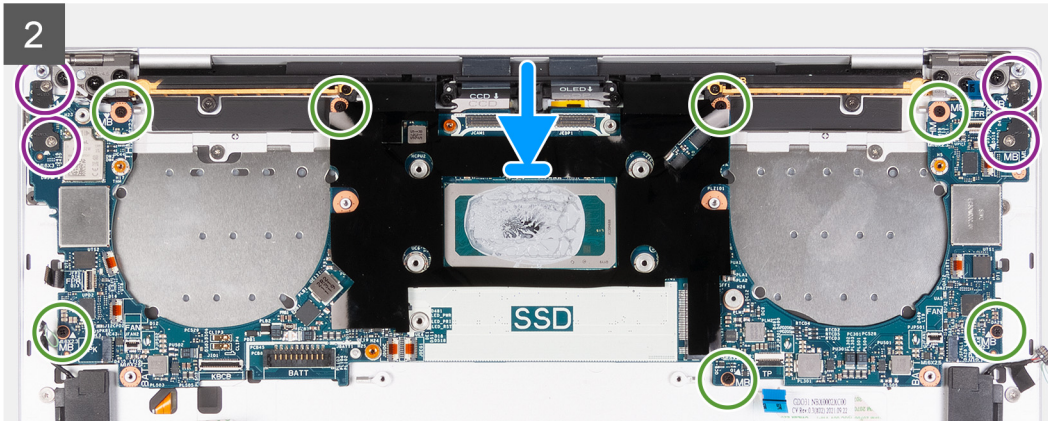

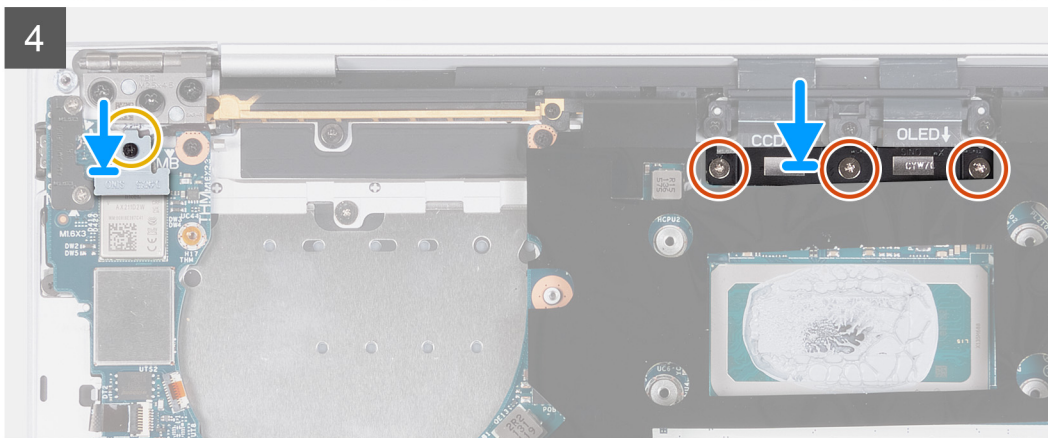
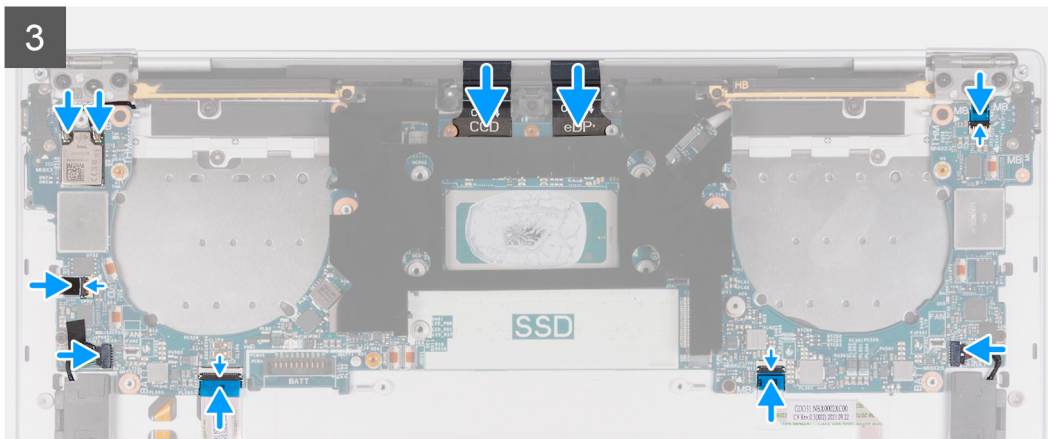

Steps

1. Align the screw holes on the system board with the screw holes on the palm-rest and keyboard assembly.
2. Hold the system board by the short edges, as shown in the image, and place the system board on the palm-rest and keyboard assembly. Ensure that the Thunderbolt 4 ports are aligned with their corresponding port holes on the palm-rest and keyboard assembly.
3. Replace the seven screws (M1.6x2.3) that secure the system board to the palm-rest and keyboard assembly.
4. Replace the four screws (M1.6x3) that secure the system board to the palm-rest and keyboard assembly.
5. Connect the power-button cable and close the latch of the power-button connector.
6. Connect the right-speaker cable.
7. Connect the keyboard control-board cable and close the latch of the keyboard control-board connector.
8. Connect the touchpad cable and close the latch of the touchpad connector.
9. Connect the left-speaker cable.
10. Connect the capacitive touch-panel cable and close the latch of the capacitive touch-panel connector.
11. Connect the camera cable and the display cable to the system board.
12. Connect the wireless-module cables from the wireless module.
13. Replace the display-assembly cable bracket on the system board.
14. Tighten the three captive screws (M1.6x2) that secure the display-assembly cable bracket to the system board.
15. Replace the wireless-module bracket on the system board.
16. Tighten the captive screw (M1.6x2.3) that secures the wireless-module bracket to the system board.

Next steps

1. Install the [heat sink](#).
2. Install the [fans](#).
3. Install the [battery](#).
4. Install the [M.2 2230 solid-state drive](#) or [M.2 2280 solid-state drive](#) from M.2 slot, whichever applicable.
5. Install the [base cover](#).

6. Follow the procedure in [After working inside your computer](#).

Power button with fingerprint reader

Removing the power button with fingerprint reader

Prerequisites

1. Follow the procedure in [Before working inside your computer](#).
2. Remove the [base cover](#).
3. Remove the [battery](#).
4. Remove the [system board](#).

NOTE: The system board can be removed with the following components attached:

- heat sink
- fans
- solid-state drive

About this task

The following image(s) indicate the location of the power button with fingerprint reader and provides a visual representation of the removal procedure.

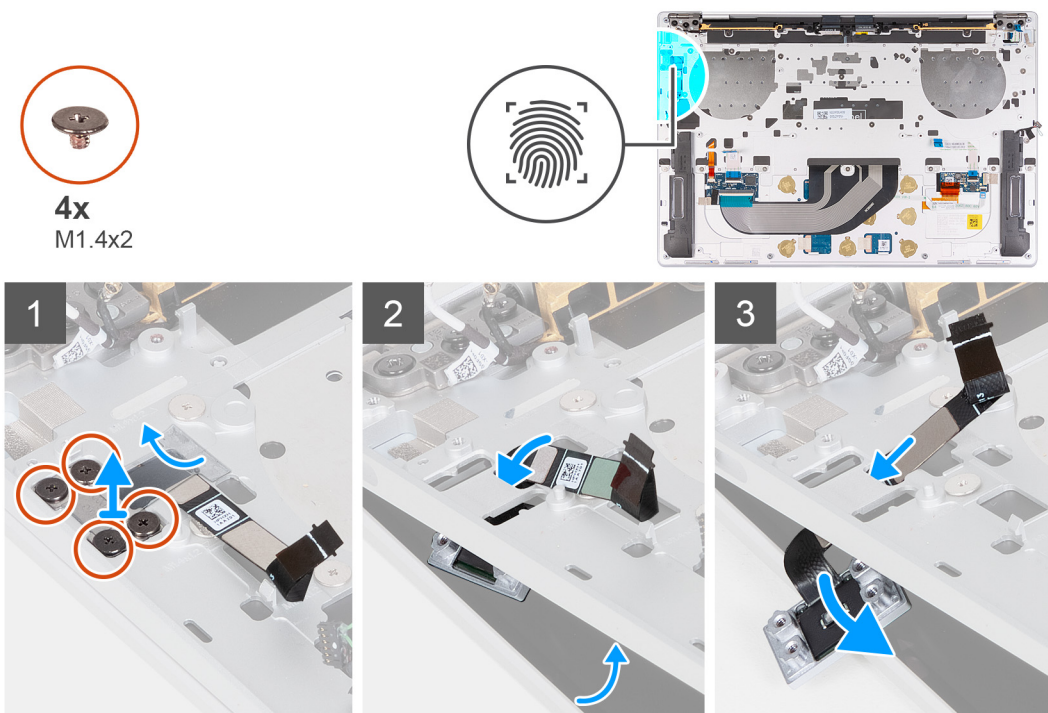

Steps

1. Open the display assembly to a 90-degree angle and place the computer on the edge of a flat surface.
2. Remove the four screws (M1.4x2) that secure the power button bracket to the palm-rest and keyboard assembly.
3. Lift the power button bracket off the palm-rest and keyboard assembly.
4. Lift the palm-rest and keyboard assembly slightly.
5. Unthread the power-button cable through the opening on the palm-rest and keyboard assembly and remove the power button with fingerprint reader.

Installing the power button with fingerprint reader

Prerequisites

If you are replacing a component, remove the existing component before performing the installation process.

About this task

The following image(s) indicate the location of the power button with fingerprint reader and provides a visual representation of the installation procedure.

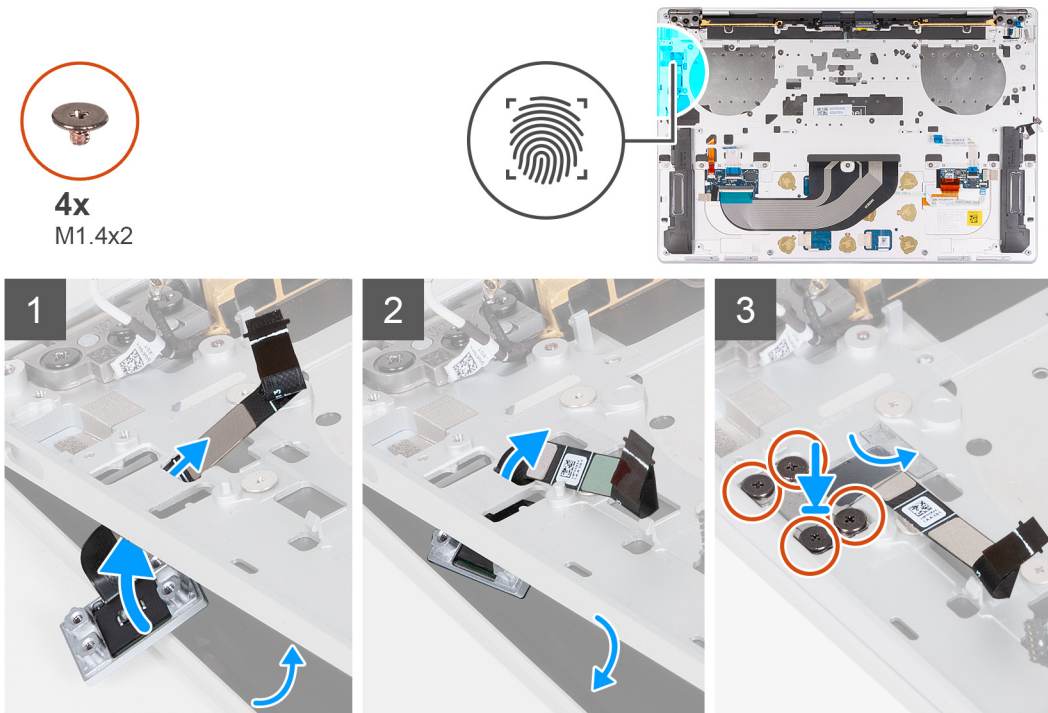

Steps

1. Open the display assembly to a 90-degree angle and place the computer on the edge of a flat surface.
2. Thread the power-button cable through the opening on the palm-rest and keyboard assembly.
3. Place the power button with fingerprint reader on the palm-rest and keyboard assembly.
4. Align the screw holes of the power button with the screw holes of the power-button bracket.
5. Replace the four screws (M1.4x2) that secure the power button bracket to the palm-rest and keyboard assembly.

Next steps

1. Install the [system board](#).



NOTE: The system board can be replaced with the following components attached:

- heat sink
- fans
- solid-state drive

2. Install the [battery](#).
3. Install the [base cover](#).
4. Follow the procedure in [After working inside your computer](#).

Keyboard

Removing the keyboard

Prerequisites

1. Follow the procedure in [Before working inside your computer](#).
2. Remove the [base cover](#).
3. Remove the [battery](#).
4. Remove the [system board](#).
 - i NOTE:** The system board can be removed with the following components attached:
 - heat sink
 - fans
 - solid-state drive
5. Remove the [power button with fingerprint reader](#).

About this task

The following image(s) indicate the location of the keyboard and provides a visual representation of the removal procedure.

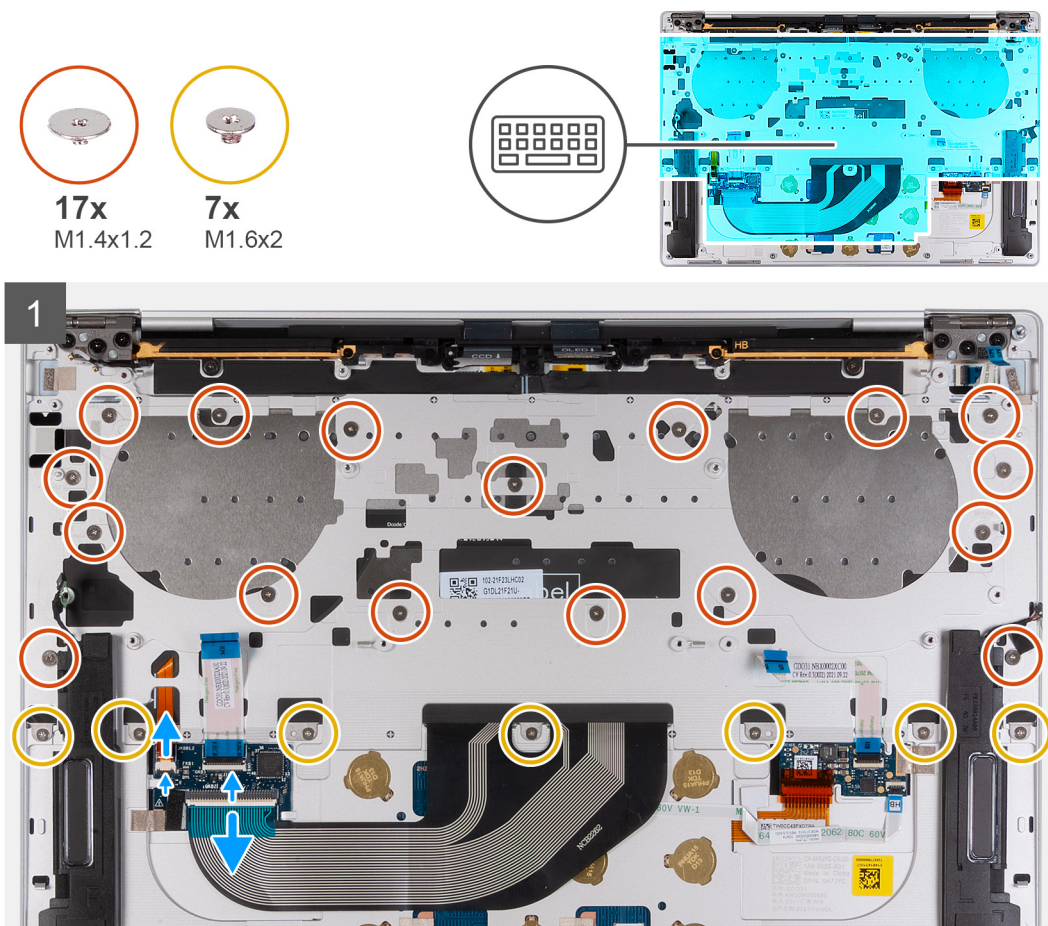

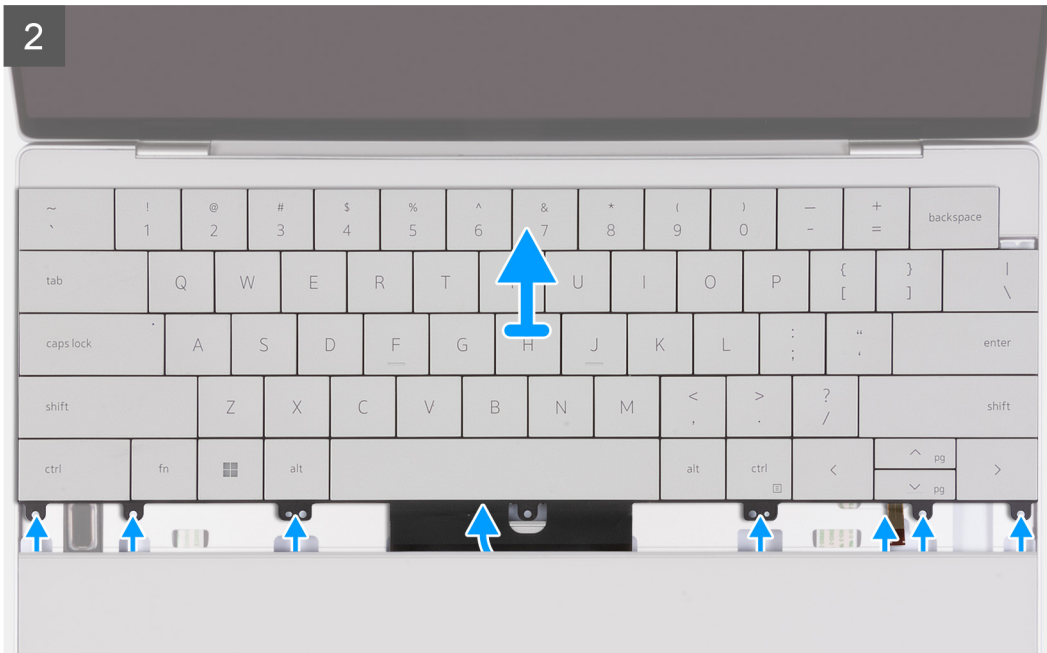

Steps

1. Remove the 17 screws (M1.4x1.2) that secure the keyboard to the palm-rest assembly.
2. Remove the seven screws (M1.6x2) that secure the keyboard to the palm-rest assembly.
3. Lift the latch of the keyboard-backlight connector and use the pull tab of the cable to disconnect the keyboard-backlight cable.
4. Lift the latch of the keyboard connector and use the pull tab of the cable to disconnect the keyboard cable.
5. Unthread the keyboard-backlight cable and the keyboard cable through the openings of the palm-rest assembly.
6. Lift the keyboard off the palm-rest assembly until the tabs of the keyboard are out from the openings on the palm-rest assembly.

Installing the keyboard

Prerequisites

If you are replacing a component, remove the existing component before performing the installation process.

About this task

The following image(s) indicate the location of the keyboard and provides a visual representation of the installation procedure.

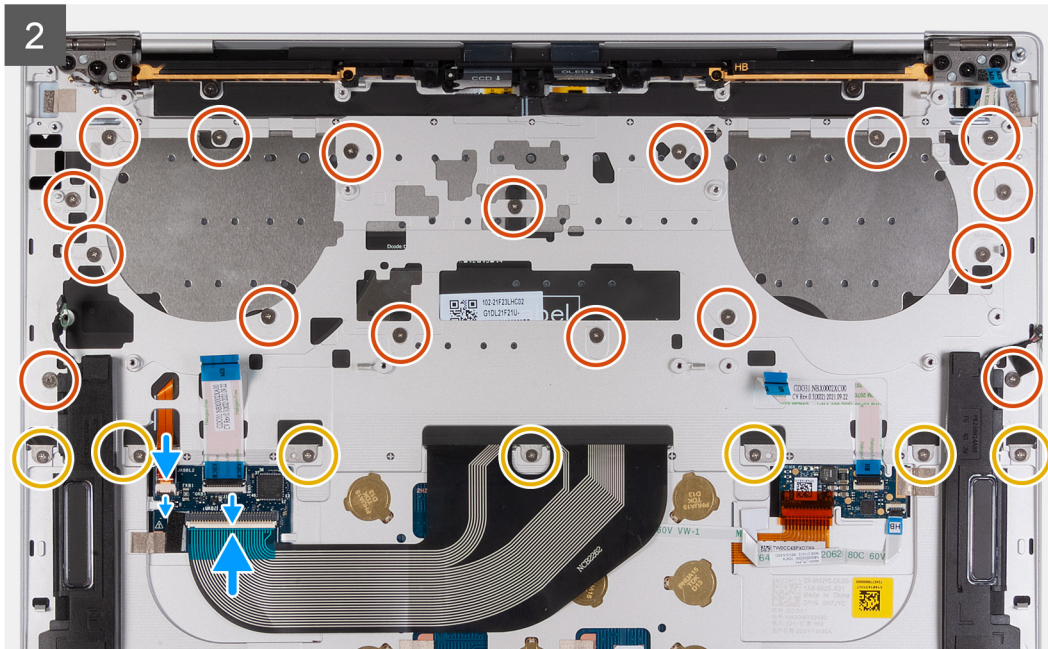
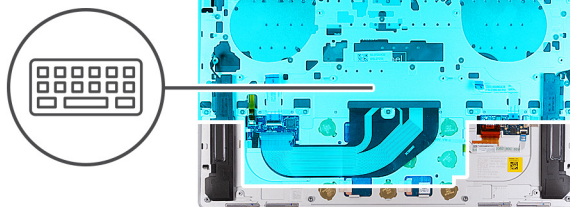
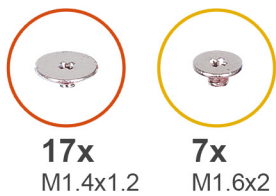
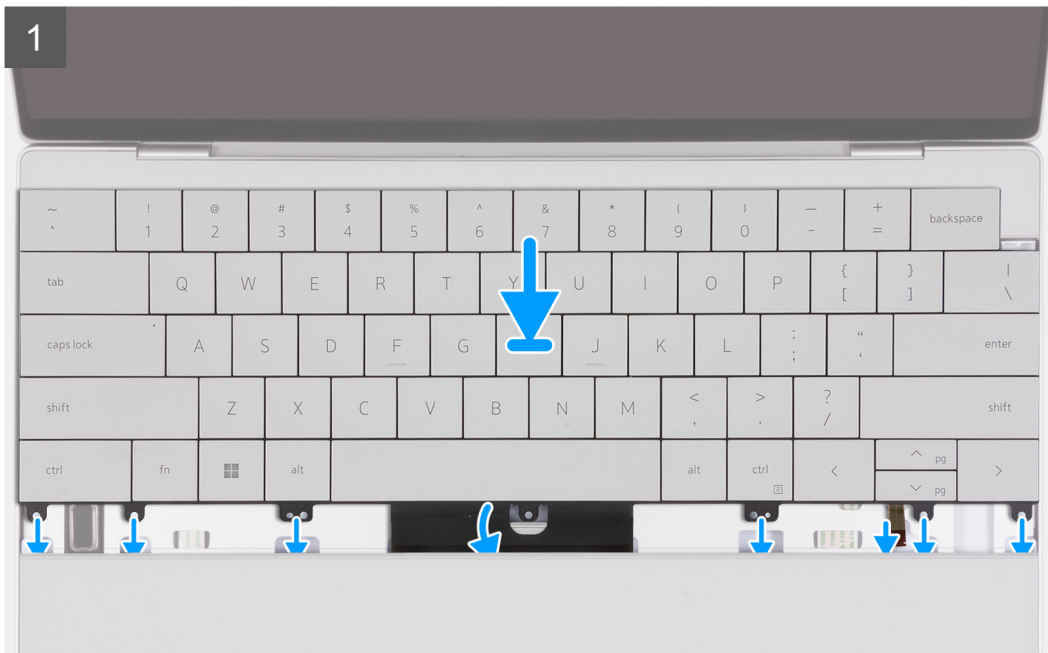

Steps

1. Align the screw holes of the keyboard with the screw holes of the palm-rest assembly.
2. Thread the keyboard-backlight cable and the keyboard cable through the openings of the palm-rest assembly.
3. Replace the seven screws (M1.6x2) that secure the keyboard to the palm-rest assembly.
4. Replace the 17 screws (M1.4x1.2) that secure the keyboard to the palm-rest assembly.
5. Connect the keyboard-backlight cable and close the latch of the keyboard-backlight connector.

6. Connect the keyboard cable and close the latch of the keyboard connector.

Next steps

1. Install the [power button with fingerprint reader](#).
2. Install the [system board](#).
 - i** **NOTE:** The system board can be replaced with the following components attached:
 - heat sink
 - fans
 - solid-state drive
3. Install the [battery](#).
4. Install the [base cover](#).
5. Follow the procedure in [After working inside your computer](#).

Palm-rest assembly

Removing the palm-rest assembly

Prerequisites

1. Follow the procedure in [Before working inside your computer](#).
2. Remove the [base cover](#).
3. Remove the [battery](#).
4. Remove the [system board](#).
 - i** **NOTE:** The system board can be removed with the following components attached:
 - heat sink
 - fans
 - solid-state drive
5. Remove the [power button with fingerprint reader](#).
6. Remove the [keyboard](#).

About this task

The following image(s) indicate the location of the palm-rest assembly and provides a visual representation of the removal procedure.

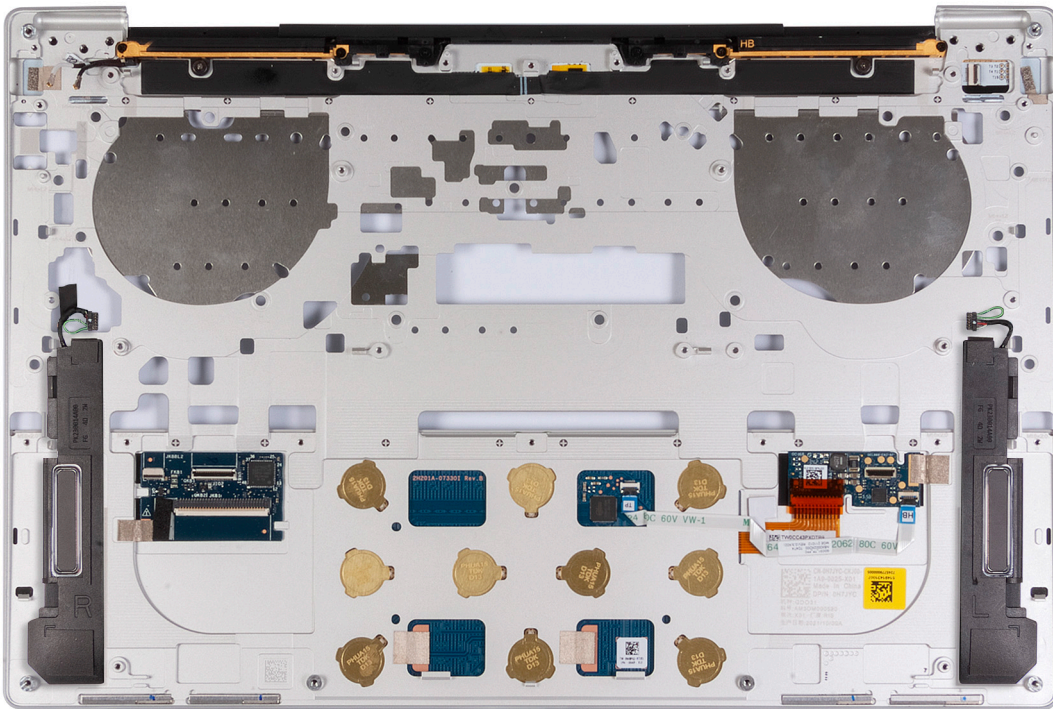

Steps

After performing the steps in the pre-requisites, you are left with the palm-rest assembly.

Installing the palm-rest assembly

Prerequisites

If you are replacing a component, remove the existing component before performing the installation process.

About this task

NOTE: The replacement palm-rest assembly comes pre-assembled with the following components that include the following:

- palm rest
- speakers
- wireless-antenna modules
- touchpad
- haptic module
- keyboard control daughterboard

The following image(s) indicate the location of the palm-rest assembly and provides a visual representation of the installation procedure.

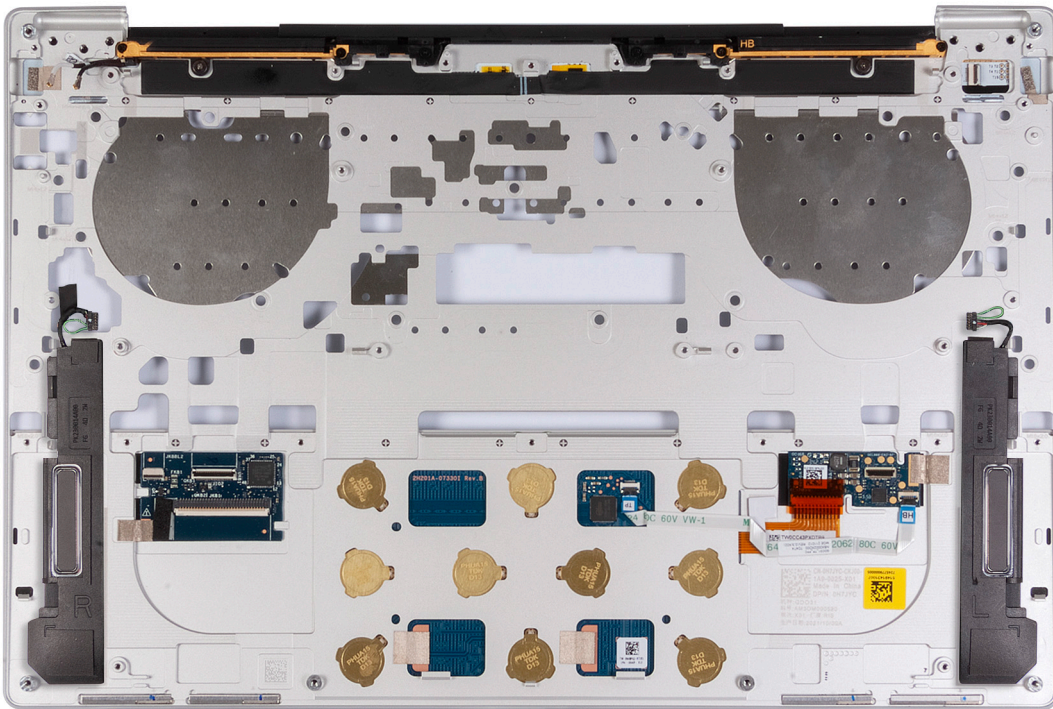

Steps

Place the palm-rest assembly on a flat surface.

Next steps

1. Install the [keyboard](#).
2. Install the [power button with fingerprint reader](#).
3. Install the [system board](#).
 - i NOTE:** The system board can be replaced with the following components pre-attached:
 - heat sink
 - fans
 - solid-state drive
4. Install the [battery](#).
5. Install the [base cover](#).
6. Follow the procedure in [After working inside your computer](#).

Drivers and downloads

When troubleshooting, downloading or installing drivers it is recommended that you read the Dell Knowledge Based article, Drivers and Downloads FAQ [000123347](#).

System setup

CAUTION: Unless you are an expert computer user, do not change the settings in the BIOS Setup program. Certain changes can make your computer work incorrectly.

NOTE: Depending on the computer and its installed devices, the items listed in this section may or may not be displayed.

NOTE: Before you change BIOS Setup program, it is recommended that you write down the BIOS Setup program screen information for future reference.

Use the BIOS Setup program for the following purposes:

- Get information about the hardware installed in your computer, such as the amount of RAM and the size of the hard drive.
- Change the system configuration information.
- Set or change a user-selectable option, such as the user password, type of hard drive installed, and enabling or disabling base devices.

Entering BIOS setup program

About this task

Turn on (or restart) your computer and press F2 immediately.

Navigation keys

NOTE: For most of the System Setup options, changes that you make are recorded but do not take effect until you restart the system.

Table 2. Navigation keys

Keys	Navigation
Up arrow	Moves to the previous field.
Down arrow	Moves to the next field.
Enter	Selects a value in the selected field (if applicable) or follow the link in the field.
Spacebar	Expands or collapses a drop-down list, if applicable.
Tab	Moves to the next focus area. NOTE: For the standard graphics browser only.
Esc	Moves to the previous page until you view the main screen. Pressing Esc in the main screen displays a message that prompts you to save any unsaved changes and restarts the system.

Boot Sequence

Boot Sequence allows you to bypass the System Setup–defined boot device order and boot directly to a specific device (for example: USB flash drive, external optical drive, or external storage device). During the Power-on Self Test (POST), when the Dell logo appears, you can:

- Access System Setup by pressing F2 key
- Bring up the one-time boot menu by pressing F12 key

The one-time boot menu displays the devices that you can boot from including the diagnostic option. The boot menu options are:

- Removable Drive (if available)
- Optical Drive (if available)
- Solid-State Drive (if available)
- Diagnostics

The boot sequence screen also displays the option to access the System Setup screen.

One time boot menu

To enter **one time boot menu**, turn on your computer, and then press F12 immediately.

 **NOTE:** It is recommended to shutdown the computer if it is on.

The one-time boot menu displays the devices that you can boot from including the diagnostic option. The boot menu options are:

- Removable Drive (if available)
- Optical Drive (if available)
- Solid-State Drive (if available)
- Diagnostics

The boot sequence screen also displays the option to access the System Setup screen.

System setup options

 **NOTE:** Depending on this computer and its installed devices, the items that are listed in this section may or may not be displayed.

Table 3. System setup options—Overview menu

Overview	
XPS 13 Plus 9320 / XPS 9320	
BIOS Version	Displays the BIOS version number.
Service Tag	Displays the Service Tag of the computer.
Asset Tag	Displays the Asset Tag of the computer.
Manufacture Date	Displays the manufacture date of the computer.
Ownership Date	Displays the ownership date of the computer.
Express Service Code	Displays the express service code of the computer.
Ownership Tag	Displays the ownership tag of the computer.
Signed Firmware Update	Displays whether the signed firmware update is enabled. Default: Enabled
BATTERY	
Primary	Displays the primary battery.
Battery Level	Displays the battery level.
Battery State	Displays the battery state.
Health	Displays the battery health.

Table 3. System setup options—Overview menu (continued)

Overview	
AC Adapter	Displays whether an AC adapter is connected. If connected, the AC adapter type.
PROCESSOR	
Processor Type	Displays the processor type.
Maximum Clock Speed	Displays the maximum processor clock speed.
Minimum Clock Speed	Displays the minimum processor clock speed.
Current Clock Speed	Displays the current processor clock speed.
Core Count	Displays the number of cores on the processor.
Processor ID	Displays the processor identification code.
Processor L2 Cache	Displays the processor L2 Cache size.
Processor L3 Cache	Displays the processor L3 Cache size.
Microcode Version	Displays the microcode version.
Intel® Hyper-Threading Capable	Displays whether the processor is Hyper-Threading (HT) capable.
64-Bit Technology	Displays whether 64-bit technology is used.
MEMORY	
Memory Installed	Displays the total computer memory installed.
Memory Available	Displays the total computer memory available.
Memory Speed	Displays the memory speed.
Memory Channel Mode	Displays single or dual channel mode.
Memory Technology	Displays the technology that is used for the memory.
DEVICES	
Panel Type	Displays the Panel Type of the computer.
Video Controller	Displays the integrate graphics information of the computer.
Video Memory	Displays the video memory information of the computer.
Wi-Fi Device	Displays the Wi-Fi device installed in the computer.
Native Resolution	Displays the native resolution of the computer.
Video BIOS Version	Displays the video BIOS version of the computer.
Audio Controller	Displays the audio controller information of the computer.
Bluetooth Device	Displays whether a Bluetooth device is installed in the computer.
Pass Through MAC Address	Displays the MAC address of the video pass-through.

Table 4. System setup options—Boot Configuration menu

Boot Configuration	
Boot Mode: UEFI only	Displays the boot mode of this computer.
Boot Sequence	Displays the boot sequence.
Secure Digital (SD) Card Boot	Enables or disables boot from Secure Digital card. By default, Enable Secure Digital (SD) Card Boot is selected.
Secure Boot	
Enable Secure Boot	Enables or disables the computer to boot using only validated boot software.

Table 4. System setup options—Boot Configuration menu (continued)



Boot Configuration	
	Default: OFF  NOTE: For Secure Boot to be enabled, the computer needs to be in UEFI boot mode and the Enable Legacy Option ROMs option needs to be turned off.
Secure Boot Mode	Selects the Secure Boot operation mode. Default: Deployed Mode  NOTE: Deployed Mode should be selected for normal operation of Secure Boot.
Expert Key Management	
Enable Custom Mode	Enables or disables the keys in the PK, KEK, db, and dbx security key databases to be modified. Default: OFF
Custom Mode Key Management	Selects the custom values for expert key management. Default: PK

Table 5. System setup options—Integrated Devices menu



Integrated Devices	
Date/Time	
Date	Sets the computer date in MM/DD/YYYY format. Changes to the date take effect immediately.
Time	Sets the computer time in HH/MM/SS 24-hour format. You can switch between 12-hour and 24-hour clock. Changes to the time take effect immediately.
Camera	
Enable Camera	Enables or disables the camera. By default, Enable Camera is selected.  NOTE: The camera setup option may not be available, depending on the configuration ordered.
Audio	
Enable Audio	Enables or disables all integrated audio controller. Default: ON
Enable Microphone	Enables or disables microphone. By default, Enable Microphone is selected.  NOTE: The microphone setup option may not be available, depending on the configuration ordered.
Enable Internal Speaker	Enables or disables internal speaker. By default, Enable Internal Speaker is selected.
USB/Thunderbolt Configuration	
Enable USB Boot Support	Enables or disables USB Boot Support. Default: Enabled
Enable External USB Ports	Enables or disables external USB ports. Default: Enabled

Table 5. System setup options—Integrated Devices menu (continued)

Integrated Devices	
Enable Thunderbolt™ Technology Support	
Enable Thunderbolt™ Technology Support	Enables or disables Thunderbolt™ Technology support. Default: ON
Enable Thunderbolt™ Boot Support	
Enable Thunderbolt™ Boot Support	Enables or disables Thunderbolt™ Boot Support. Default: OFF
Enable Thunderbolt™ (and PCIe behind TBT) pre-boot modules	
Enable Thunderbolt™ (and PCIe behind TBT) pre-boot modules	Enables or disables to allow or disallow PCIe devices to be connected through a Thunderbolt™ adapter during pre-boot. Default: OFF
Disable USB4 PCIE Tunneling	Disables USB4 PCIE Tunneling. Default: OFF
Video/Power only on Type-C Ports	Limits Type-C port functionality to video or power only. Default: OFF
Type-C Dock	
Type-C Dock Override	Allows user to use connected Type-C Dell docking station to provide data stream while the external USB ports are disabled. Default: ON
Type-C Dock Audio	Allows user to have audio inputs and outputs from the connected Type-C Dell docking station. Default: ON
Type-C Dock LAN	Enable or disable the LAN on the external ports of the connected Type-C Dell docking station. Default: ON
Miscellaneous Devices	
Enable Fingerprint Reader Device	Enables or disables the Fingerprint Reader Device. By default, Enable Fingerprint Reader Device is selected.

Table 6. System setup options—Storage menu

Storage	
SATA/NVMe Operation	
SATA/NVMe Operation	Configures operating mode of the integrated SATA hard drive controller. Default: AHCI/NVMe. Storage device is configured for AHCI/NVMe mode.
Storage Interface	
Port Enablement	Enables or disables the M.2 PCIe SSD. Default: ON
Drive Information	Displays the information of onboard drives.

Table 6. System setup options—Storage menu (continued)

Storage	
Enable MediaCard	Enables to switch all media cards On/Off or set the media card to read-only state. By default, Enable Secure Digital (SD) Card is selected.

Table 7. System setup options—Display menu

Display	
Display Brightness	
Brightness on battery power	Sets the screen brightness when the computer is running on battery power. Default: 50
Brightness on AC power	Sets the screen brightness when the computer is running on AC power. Default: 100
Touchscreen	
Touchscreen	Enables or disables the touchscreen. Default: ON
Full Screen Logo	
Full Screen Logo	Enabled or disabled the computer to display full screen logo if the image match screen resolution. Default: OFF

Table 8. System setup options—Connection menu

Connection	
Wireless Device Enable	Enable or disable internal WLAN/Bluetooth devices. By default, WLAN is selected. By default, Bluetooth is selected.
Enable UEFI Network Stack	
Enable UEFI Network Stack	Enables or disables UEFI Network Stack. Default: ON
Wireless Radio Control	
Control WLAN radio	Enables to sense the connection of the computer to a wired network and subsequently disable the selected wireless radios (WLAN and/or WWAN). Upon disconnection from the wired network, the selected wireless radios are re-enabled. Default: OFF

Table 9. System setup options—Power menu

Power	
Battery Configuration	
Battery Configuration	Enables the computer to run on battery during power usage hours. Use the below options to prevent AC power usage between certain times of each day. Default: Adaptive. Battery settings are adaptively optimized based on your typical battery usage pattern.
Advanced Configuration	

Table 9. System setup options—Power menu (continued)

Power	
Enable Advanced Battery Charge Configuration	Enables Advanced Battery Charge Configuration from the beginning of the day to a specified work period. Advanced Battery Charged maximizes battery health while still supporting heavy use during the work day. Default: OFF
Peak Shift	
Enable Peak Shift	Enables the computer to run on battery during peak power usage hours. Default: OFF
Thermal Management	
Thermal Management	Adjusts system performance, noise, and temperature. Default: Optimized. Standard setting for balance of performance, noise, and temperature.
USB Wake Support	
Wake on Dell USB-C Dock	Enables connecting a Dell USB-C Dock to wake the computer from Standby. Default: ON
Block Sleep	
Block Sleep	Blocks the computer from entering Sleep (S3) mode in the operating system. Default: OFF i NOTE: If enabled, the computer will not go to sleep, Intel® Rapid Start will be disabled automatically, and the operating system power option will be blank if it was set to Sleep.
Lid Switch	
Enable Lid Switch	Enables or disables the lid switch.
Power On Lid Open	Enables the computer to power up from the off state whenever the lid is opened. Default: ON
Intel® Speed Shift Technology	Enables or disables the Intel® Speed Shift Technology support. Setting this option to enable allows the operating system to select the appropriate processor performance automatically. Default: ON

Table 10. System setup options—Security menu

Security	
TPM 2.0 Security On	
TPM 2.0 Security On	Select whether or not the Trusted Platform Model (TPM) is visible to the OS. Default: ON
PPI Bypass for Enable Commands	Enables or disables the OS to skip BIOS Physical Presence Interface (PPI) user prompts when issuing TPM PPI enabled and activate commands. Default: OFF
PPI Bypass for Disable Commands	Enables or disables The OS to skip BIOS PPI user prompts when issuing TPM PPI Disable and Deactivate commands. Default: OFF

Table 10. System setup options—Security menu (continued)



Security	
Attestation Enable	Enables to control whether the TPM Endorsement Hierarchy is available to the OS. Disabling this setting restricts the ability to use the TPM for signature operations. Default: ON
Key Storage Enable	Enables to control whether the TPM Endorsement Hierarchy is available to the OS. Disabling this setting restricts the ability to use the TPM for storing owner data. Default: ON
SHA-256	Enables or disables the BIOS and the TPM to use the SHA-256 hash algorithm to extend measurements into the TPM PCRs during BIOS boot. Default: ON
Clear	Enables or disables the computer to clear the PTT owner information, and returns the PTT to the default state. Default: OFF
PPI Bypass for Clear Commands	Enables or disables the operating system to skip BIOS Physical Presence Interface (PPI) user prompts when issuing the Clear command. Default: OFF
TPM State	Enables or disables the TPM. This is the normal operating state for the TPM when you want to use its complete array of capabilities. Default: Enabled
SMM Security Mitigation	
SMM Security Mitigation	Enables or disables additional UEFI SMM Security Mitigation protections. Default: OFF  NOTE: This feature may cause compatibility issues or loss of functionality with some legacy tools and applications.
Data Wipe on Next Boot	
Start Data Wipe	 CAUTION: This Secure Wipe Operation deletes information in a way that it cannot be reconstructed. If enabled, the BIOS will queue up a data wipe cycle for storage devices that are connected to the motherboard on the next reboot. Default: OFF
Absolute	
Absolute	Enables, disables or permanently disable the BIOS module interface of the optional Absolute Persistence Module service from Absolute Software. Default: Enabled
UEFI Boot Path Security	
UEFI Boot Path Security	Enables or disables the system to prompt the user to enter the Admin password when booting a UEFI boot path from the F12 boot menu. Default: Always Except Internal HDD

Table 11. System setup options—Passwords menu

Passwords	
Admin Password	Sets, Changes, or deletes the administrator (admin) password (sometimes called the "setup" password).
System Password	Sets, Changes, or deletes the system password.
Password Configuration	
Upper Case Letter	Enables or disables the requirement for at least one upper case letter. Default: OFF
Lower Case Letter	Enables or disables the requirement for at least one lower case letter. Default: OFF
Digit	Enables or disables the requirement for at least one digit number. Default: OFF
Special Character	Enables or disables the requirement for at least one special character. Default: OFF
Minimum Characters	Specify the minimum number of characters allowed for the password. Default: 4
Password Bypass	
Password Bypass	Bypass the System (Boot) Password and the internal hard drive password prompts during a system restart. Default: Disabled
Password Changes	
Enable Non-Admin Password Changes	Enables or disables the user to change the system and hard drive password without the need for admin password. Default: ON
Admin Setup Lockout	
Enable Admin Setup Lockout	Enables or disables the user from entering BIOS Setup when an Admin Password is set. Default: OFF
Master Password Lockout	
Enable Master Password Lockout	Enables or disables the master password support. Default: OFF

Table 12. System setup options—Update, Recovery menu

Update, Recovery	
UEFI Capsule Firmware Updates	
Enable UEFI Capsule Firmware Updates	Enables or disables BIOS updates through UEFI capsule update packages. Default: ON
BIOS Recovery from Hard Drive	
BIOS Recovery from Hard Drive	Enables the computer to recover from a bad BIOS image, as long as the Boot Block portion is intact and functioning. Default: ON

Table 12. System setup options—Update, Recovery menu (continued)

Update, Recovery	
	<p>i NOTE: BIOS recovery is designed to fix the main BIOS block and cannot work if the Boot Block is damaged. In addition, this feature cannot work in the event of EC corruption, ME corruption, or a hardware issue. The recovery image must exist on an unencrypted partition on the drive.</p>
BIOS Downgrade	
Allow BIOS Downgrade	<p>Controls flashing of the system firmware to previous revisions.</p> <p>Default: ON</p>
SupportAssist OS Recovery	
SupportAssist OS Recovery	<p>Enables or disables the boot flow for SupportAssist OS Recovery tool in the event of certain system errors.</p> <p>Default: ON</p>
BIOSConnect	
BIOSConnect	<p>Enables or disables cloud Service OS recover if the main operating system fails to boot with the number of failures equal to or greater than the value specified by the Auto OS Recovery Threshold setup option.</p> <p>Default: ON</p>
Dell Auto OS Recovery Threshold	
Dell Auto OS Recovery Threshold	<p>Controls the automatic boot flow for SupportAssist System Resolution Console and for Dell operating system Recovery tool.</p> <p>Default: 2</p>

Table 13. System setup options—System Management menu

System Management	
Service Tag	
Service Tag	<p>Displays the Service Tag of the computer.</p>
Asset Tag	
Asset Tag	<p>Creates a system Asset Tag that can be used by an IT administrator to uniquely identify a particular system. Once set in BIOS, the Asset Tag cannot be changed.</p>
AC Behavior	
Wake on AC	<p>Enables the computer to turn on and go to boot when AC power is supplied to the computer.</p> <p>Default: OFF</p>
Wake on LAN	
Wake on LAN	<p>Enables or disables the computer to turn on by a special LAN signal.</p> <p>Default: Disabled</p>
Auto On Time	
Auto On Time	<p>Enables the computer to automatically power on for defined days and times.</p> <p>Default: Disabled. The system will not automatically power up.</p>

Table 14. System setup options—Keyboard menu

Keyboard	
Fn Lock Options	
Fn Lock Options	Enables or disables the Fn lock mode. Default: ON
Lock Mode	Default: Lock Mode Secondary. Lock Mode Secondary = If this option is selected, the F1-F12 keys scan the code for their secondary functions.
Keyboard Illumination	
Keyboard Illumination	Configures the operating mode of the keyboard illumination feature. Default: Bright. Enable the keyboard illumination feature at 100% brightness level.
Keyboard Backlight Timeout on AC	
Keyboard Backlight Timeout on AC	Configures the timeout value for the keyboard when an AC adapter is connected to the computer. The keyboard backlight timeout value is only effect when the backlight is enabled. Default: 10 seconds
Keyboard Backlight Timeout on Battery	
Keyboard Backlight Timeout on Battery	Configures the timeout value for the keyboard when the computer is running on battery. The keyboard backlight timeout value is only effect when the backlight is enabled. Default: 10 seconds
Device Configuration HotKey Access	
Device Configuration HotKey Access	Configures the hotkey access of the computer. Default: Enabled

Table 15. System setup options—Pre-boot Behavior menu

Pre-boot Behavior	
Adapter Warnings	
Enable Dock Warning Messages	Enables or disables dock warning messages. Default: ON
Warnings and Errors	
Warnings and Errors	Selects an action on encountering a warning or error during boot. Default: Prompt on Warnings and Errors. Stop, prompt, and wait for user input when warnings or errors are detected.  NOTE: Errors deemed critical to the operation of the computer hardware will always halt the computer.
USB-C Warnings	
Enable Dock Warning Messages	Enables or disables dock warning messages. Default: ON
Fastboot	
Fastboot	Configures the speed of the UEFI boot process. Default: Thorough. Performs complete hardware and configuration initialization during boot.

Table 15. System setup options—Pre-boot Behavior menu (continued)

Pre-boot Behavior	
Extend BIOS POST Time	
Extend BIOS POST Time	Configures the BIOS POST (Power-On Self-Test) load time. Default: 0 seconds
MAC Address Pass-Through	
MAC Address Pass-Through	Replaces the external NIC MAC address (in a supported dock or dongle) with the selected MAC address from the computer. Default: System Unique MAC Address.
Mouse/Touchpad	
Mouse/Touchpad	Defines how the computer handles mouse and touchpad input. Default: Touchpad and PS/2 Mouse. Leave the integrated touchpad enabled when an external PS/2 mouse is present.
Sign of Life	
Early Logo Display	Display Logo Sign of Life. Default: ON
Early Keyboard Backlight	Keyboard Backlight Sign of Life. Default: ON

Table 16. System setup options—Virtualization menu

Virtualization Support	
Intel® Virtualization Technology	
Enable Intel® Virtualization Technology (VT)	Enables the computer to run a virtual machine monitor (VMM). Default: ON
VT for Direct I/O	
Enable Intel® VT for Direct I/O	Enables the computer to perform Virtualization Technology for Direct I/O (VT-d). VT-d is an Intel® method that provides virtualization for memory map I/O. Default: ON
Intel® Trusted Execution Technology (TXT)	Enables Intel® Trusted Execution Technology (TXT). Default: OFF
DMA Protection	
Enable Pre-Boot DMA Support	Controls Pre-Boot DMA protection for both Internal and External ports. Default: ON
Enable OS Kernel DMA Support	Controls Kernel DMA protection for both Internal and External ports. This setting does not directly enable DMA protection in the OS. Default: ON

Table 17. System setup options—Performance menu

Performance	
Multi-Core Support	
Multiple Atom Cores	Changes the number of Atom cores available to the operating system. The default value is set to the maximum number of cores.

Table 17. System setup options—Performance menu (continued)

Performance	
	Default: All Cores
Intel® SpeedStep	
Enable Intel® SpeedStep Technology	Enables or disables the Intel® SpeedStep Technology to dynamically adjust processor voltage and core frequency, decreasing average power consumption and heat production. Default: ON
C-State Control	
Enable C-State Control	Enables or disables the CPU's ability to enter and exit low-power states. Default: ON
Intel® Turbo Boost Technology	
Enable Intel® Turbo Boost Technology	Enabled or disabled the Intel® TurboBoost mode of the processor. If enabled, the Intel® TurboBoost driver increases the performance of the CPU or graphics processor. Default: ON
Intel® Hyper-Threading Technology	
Enable Intel® Hyper-Threading Technology	Enabled or disabled the Intel® Hyper-Threading mode of the processor. If enabled, the Intel® Hyper-Threading increases the efficiency of the processor resources when multiple threads run on each core. Default: ON
Dynamic Tuning:Machine Learning	
Enable Dynamic Tuning:Machine Learning	Enabled or disabled OS capability to enhance power tuning capabilities based on detected workloads. Note: This option is only for development only and will not be customer visible. Default: ON

Table 18. System setup options—System Logs menu

System Logs	
BIOS Event Log	
Clear BIOS Event Log	Select keep or clear BIOS events logs. Default: Keep Log
Thermal Event Log	
Clear Thermal Event Log	Select keep or clear Thermal events logs. Default: Keep Log
Power Event Log	
Clear Power Event Log	Select keep or clear Power events logs. Default: Keep Log

System and setup password

Table 19. System and setup password

Password type	Description
System password	Password that you must enter to log in to your system.
Setup password	Password that you must enter to access and make changes to the BIOS settings of your computer.

You can create a system password and a setup password to secure your computer.

 **CAUTION:** The password features provide a basic level of security for the data on your computer.

 **CAUTION:** Anyone can access the data that is stored on your computer if it is not locked and left unattended.

 **NOTE:** System and setup password feature is disabled.

Assigning a system setup password

Prerequisites

You can assign a new **System or Admin Password** only when the status is in **Not Set**.

About this task

To enter the system setup, press F12 immediately after a power-on or reboot.

Steps

1. In the **System BIOS** or **System Setup** screen, select **Security** and press Enter.
The **Security** screen is displayed.
2. Select **System/Admin Password** and create a password in the **Enter the new password** field.
Use the following guidelines to assign the system password:
 - A password can have up to 32 characters.
 - At least one special character: ! " # \$ % & ' () * + , - . / : ; < = > ? @ [\] ^ _ ` { | }
 - Numbers 0 through 9.
 - Upper case letters from A to Z.
 - Lower case letters from a to z.
3. Type the system password that you entered earlier in the **Confirm new password** field and click **OK**.
4. Press Esc and save the changes as prompted by the pop-up message.
5. Press Y to save the changes.
The computer restarts.

Deleting or changing an existing system setup password

Prerequisites

Ensure that the **Password Status** is Unlocked (in the System Setup) before attempting to delete or change the existing System and/or Setup password. You cannot delete or change an existing System or Setup password, if the **Password Status** is Locked.

About this task

To enter the System Setup, press F12 immediately after a power-on or reboot.

Steps

1. In the **System BIOS** or **System Setup** screen, select **System Security** and press Enter.
The **System Security** screen is displayed.
2. In the **System Security** screen, verify that **Password Status** is **Unlocked**.
3. Select **System Password**, update, or delete the existing system password, and press Enter or Tab.
4. Select **Setup Password**, update, or delete the existing setup password, and press Enter or Tab.
 **NOTE:** If you change the System and/or Setup password, reenter the new password when prompted. If you delete the System and/or Setup password, confirm the deletion when prompted.
5. Press Esc and a message prompts you to save the changes.
6. Press Y to save the changes and exit from System Setup.
The computer restarts.

Clearing BIOS (System Setup) and System passwords

About this task

To clear the system or BIOS passwords, contact Dell technical support as described at www.dell.com/contactdell.

-  **NOTE:** For information on how to reset Windows or application passwords, refer to the documentation accompanying Windows or your application.

Updating the BIOS

Updating the BIOS in Windows

Steps

1. Go to www.dell.com/support.
2. Click **Product support**. In the **Search support** box, enter the Service Tag of your computer, and then click **Search**.
 **NOTE:** If you do not have the Service Tag, use the SupportAssist feature to automatically identify your computer. You can also use the product ID or manually browse for your computer model.
3. Click **Drivers & Downloads**. Expand **Find drivers**.
4. Select the operating system installed on your computer.
5. In the **Category** drop-down list, select **BIOS**.
6. Select the latest version of BIOS, and click **Download** to download the BIOS file for your computer.
7. After the download is complete, browse the folder where you saved the BIOS update file.
8. Double-click the BIOS update file icon and follow the on-screen instructions.
For more information, see knowledge base article [000124211](http://www.dell.com/support) at www.dell.com/support.

Updating the BIOS using the USB drive in Windows

Steps

1. Follow the procedure from step 1 to step 6 in [Updating the BIOS in Windows](#) to download the latest BIOS setup program file.
2. Create a bootable USB drive. For more information, see the knowledge base article [000145519](http://www.dell.com/support) at www.dell.com/support.
3. Copy the BIOS setup program file to the bootable USB drive.
4. Connect the bootable USB drive to the computer that needs the BIOS update.
5. Restart the computer and press **F12**.
6. Select the USB drive from the **One Time Boot Menu**.
7. Type the BIOS setup program filename and press **Enter**.
The **BIOS Update Utility** appears.

8. Follow the on-screen instructions to complete the BIOS update.

Updating the BIOS from the F12 One-Time boot menu

Update your computer BIOS using the BIOS update.exe file that is copied to a FAT32 USB drive and booting from the F12 One-Time boot menu.

About this task

BIOS Update

You can run the BIOS update file from Windows using a bootable USB drive or you can also update the BIOS from the F12 One-Time boot menu on the computer.

Most of the Dell computers built after 2012 have this capability, and you can confirm by booting your computer to the F12 One-Time Boot Menu to see if BIOS FLASH UPDATE is listed as a boot option for your computer. If the option is listed, then the BIOS supports this BIOS update option.

 **NOTE:** Only computers with BIOS Flash Update option in the F12 One-Time boot menu can use this function.

Updating from the One-Time boot menu

To update your BIOS from the F12 One-Time boot menu, you need the following:

- USB drive formatted to the FAT32 file system (key does not have to be bootable)
- BIOS executable file that you downloaded from the Dell Support website and copied to the root of the USB drive
- AC power adapter that is connected to the computer
- Functional computer battery to flash the BIOS

Perform the following steps to perform the BIOS update flash process from the F12 menu:

 **CAUTION: Do not turn off the computer during the BIOS update process. The computer may not boot if you turn off your computer.**

Steps

1. From a turn off state, insert the USB drive where you copied the flash into a USB port of the computer.
2. Turn on the computer and press F12 to access the One-Time Boot Menu, select BIOS Update using the mouse or arrow keys then press Enter.
The flash BIOS menu is displayed.
3. Click **Flash from file**.
4. Select external USB device.
5. Select the file and double-click the flash target file, and then click **Submit**.
6. Click **Update BIOS**. The computer restarts to flash the BIOS.
7. The computer will restart after the BIOS update is completed.

Troubleshooting

Handling swollen Lithium-ion batteries

Like most laptops, Dell laptops use lithium-ion batteries. One type of lithium-ion battery is the lithium-ion polymer battery. Lithium-ion polymer batteries have increased in popularity in recent years and have become standard in the electronics industry due to customer preferences for a slim form factor (especially with newer ultra-thin laptops) and long battery life. Inherent to lithium-ion polymer battery technology is the potential for swelling of the battery cells.

Swollen battery may impact the performance of the laptop. To prevent possible further damage to the device enclosure or internal components leading to malfunction, discontinue the use of the laptop and discharge it by disconnecting the AC adapter and letting the battery drain.

Swollen batteries should not be used and should be replaced and disposed of properly. We recommend contacting Dell product support for options to replace a swollen battery under the terms of the applicable warranty or service contract, including options for replacement by a Dell authorized service technician.

The guidelines for handling and replacing Lithium-ion batteries are as follows:

- Exercise caution when handling Lithium-ion batteries.
- Discharge the battery before removing it from the computer. To discharge the battery, unplug the AC adapter from the computer and operate the computer only on battery power. When the computer will no longer turn on when the power button is pressed, the battery is fully discharged.
- Do not crush, drop, mutilate, or penetrate the battery with foreign objects.
- Do not expose the battery to high temperatures, or disassemble battery packs and cells.
- Do not apply pressure to the surface of the battery.
- Do not bend the battery.
- Do not use tools of any type to pry on or against the battery.
- If a battery gets stuck in a device as a result of swelling, do not try to free it as puncturing, bending, or crushing a battery can be dangerous.
- Do not attempt to reassemble a damaged or swollen battery into a laptop.
- Swollen batteries that are covered under warranty should be returned to Dell in an approved shipping container (provided by Dell)—this step is to comply with transportation regulations. Swollen batteries that are not covered under warranty should be disposed of at an approved recycling center. Contact Dell product support at <https://www.dell.com/support> for assistance and further instructions.
- Using a non-Dell or incompatible battery may increase the risk of fire or explosion. Replace the battery only with a compatible battery purchased from Dell that is designed to work with your Dell computer. Do not use a battery from other computers with your computer. Always purchase genuine batteries from <https://www.dell.com> or otherwise directly from Dell.

Lithium-ion batteries can swell for various reasons such as age, number of charge cycles, or exposure to high heat. For more information about how to improve the performance and lifespan of the laptop battery and to minimize the possibility of occurrence of the issue, see [Dell Laptop Battery - Frequently Asked Questions](#).

Locate the Service Tag or Express Service Code of your Dell computer

Your Dell computer is uniquely identified by a Service Tag or Express Service Code. To view relevant support resources for your Dell computer, we recommend entering the Service Tag or Express Service Code at www.dell.com/support.

For more information on how to find the Service Tag for your computer, see [Locate the Service Tag for your Dell Laptop](#).

System diagnostic lights

When static, the Service LED indicates the power mode that your computer is in. When blinking in different patterns, the power and battery-charge status light indicates the respective issues that your computer is encountering.

Static power and battery-charge status light

The following table lists the status of your computer based on the Service LED.

Table 20. Service LED

Power and battery-charge status light	Status of computer
Solid white	<ul style="list-style-type: none">• The power adapter is connected, and the battery is fully charged.• The power adapter is connected, and the battery has more than five percent charge.
Amber	The computer is running on battery, and the battery has less than five percent charge.
Off	The computer is in sleep state, hibernation, or turned off.

Table 21. LED codes

Diagnostic light codes	Problem description
2,1	Processor failure
2,2	System board: BIOS or ROM (Read-Only Memory) failure
2,3	No memory or RAM (Random-Access Memory) detected
2,4	Memory or RAM (Random-Access Memory) failure
2,5	Invalid memory installed
2,6	System-board or chipset error
2,7	Display failure
2,8	Display power failure
3,2	PCI, video card/chip failure
3,3	Recovery image not found
3,4	Recovery image found but invalid
3,5	Power-rail failure
3,6	System BIOS Flash incomplete
3,7	Management Engine (ME) error

SupportAssist diagnostics

About this task

The SupportAssist diagnostics (previously known as ePSA diagnostics) performs a complete check of your hardware. The SupportAssist diagnostics is embedded in the BIOS and is launched by it internally. The SupportAssist diagnostics provides a set of options for particular devices or device groups. It allows you to:

- Run tests automatically or in an interactive mode.
- Repeat tests
- Display or save test results
- Run thorough tests to introduce additional test options and provide extra information about the failed device(s)
- View status messages that indicate if the tests are completed successfully
- View error messages that indicate if problems were encountered during the test

NOTE: Some tests are meant for specific devices and require user interaction. Ensure that you are present in front of the computer when the diagnostic tests are performed.

For more information, see [SupportAssist Pre-Boot System Performance Check](#).

Built-in self-test (BIST)

System board built-in self-test (M-BIST)

About this task



Steps

1. Press and hold both the M key and the power button to initiate M-BIST.
2. The battery-status light illuminates in amber when there is a failure with the system board.
3. Replace the system board to fix the issue.

NOTE: The battery status LED will not illuminate if there is no failure present with the system board. If further troubleshooting is required, proceed with the applicable Guided Resolution for No Power/No POST, etc.

Display panel power rail built-in self-test (L-BIST)

About this task

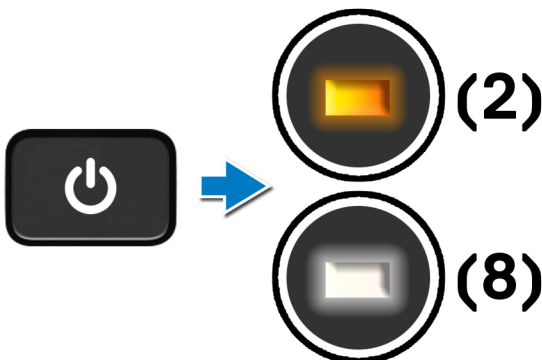

Next steps

L-BIST (LCD Power Rail Test) is an enhancement to the single LED error code diagnostics and is **automatically initiated** during **POST**. L-BIST isolates if the LCD is receiving power from the system board. L-BIST checks if the system board is supplying power to the LCD by performing an LCD Power Rail test. If there is no power going to the LCD, the battery status LED flashes a **[2,8] LED error code**.

Display panel built-in self-test (LCD-BIST)

About this task

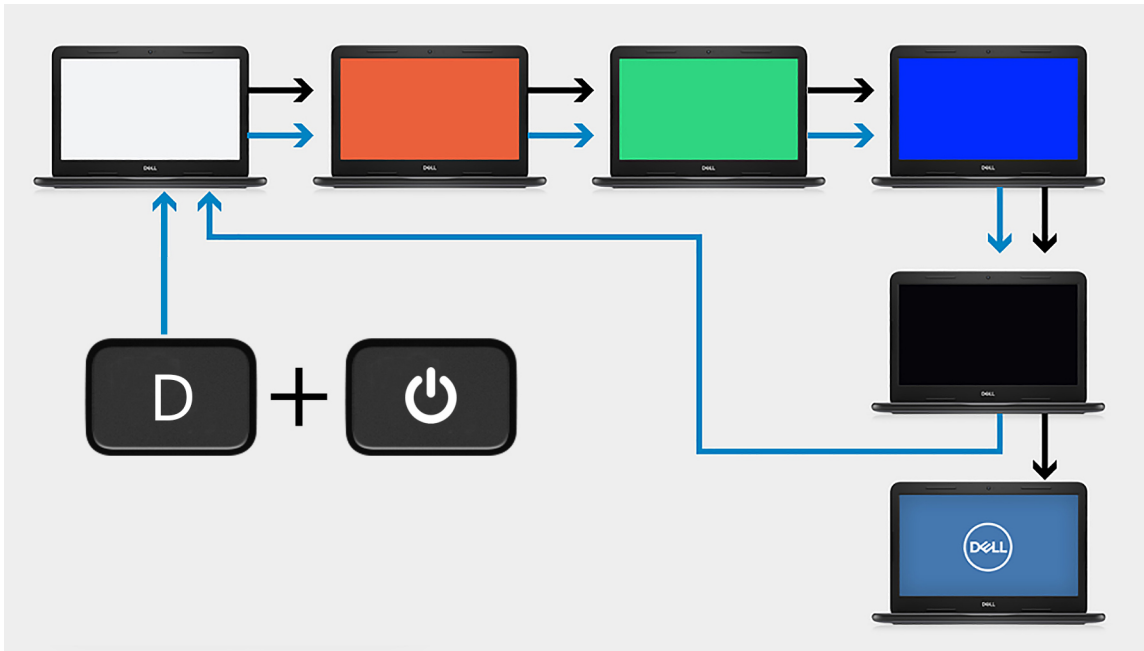

Steps

1. Press and hold the D key and then press the power button.
2. Release both the D key and the power button when the computer begins POST.
3. The display panel begins to display a solid color, or cycling through different colors.
 - NOTE:** The sequence of colors may vary due to different display panel vendor. The user only needs to ensure that the colors are being displayed correctly without distortion or graphical anomalies.
4. The computer reboots at the end of the last solid color.

Outcome

About this task

The following table shows the outcome of running different types of BIST.

Table 22. BIST outcome

M-BIST	
Off	No fault detected with system board.
Solid amber	Indicates a problem with the system board.

Table 22. BIST outcome

L-BIST	
Off	No fault detected with system board.
LED error code of [2,8] blinks Amber x2, then pause, then blinks White x8	Indicates a problem with the system board.

Table 22. BIST outcome

LCD-BIST
The LCD that flashes White, Red, Green, and Blue shows that the display is working fine and there is no fault with the LCD panel.

Recovering the operating system

When your computer is unable to boot to the operating system even after repeated attempts, it automatically starts Dell SupportAssist OS Recovery.

Dell SupportAssist OS Recovery is a standalone tool that is preinstalled in all Dell computers installed with Windows operating system. It consists of tools to diagnose and troubleshoot issues that may occur before your computer boots to the operating system. It enables you to diagnose hardware issues, repair your computer, back up your files, or restore your computer to its factory state.

You can also download it from the Dell Support website to troubleshoot and fix your computer when it fails to boot into their primary operating system due to software or hardware failures.

For more information about the Dell SupportAssist OS Recovery, see *Dell SupportAssist OS Recovery User's Guide* at www.dell.com/serviceabilitytools. Click **SupportAssist** and then, click **SupportAssist OS Recovery**.

WiFi power cycle

About this task

If your computer is unable to access the Internet due to WiFi connectivity issues, a WiFi power cycle procedure may be performed. The following procedure provides the instructions on how to conduct a WiFi power cycle:

 **NOTE:** Some ISPs (Internet Service Providers) provide a modem/router combo device.

Steps

1. Turn off your computer.
2. Turn off the modem.
3. Turn off the wireless router.
4. Wait for 30 seconds.
5. Turn on the wireless router.
6. Turn on the modem.
7. Turn on your computer.

Drain residual flea power (perform hard reset)

About this task

Flea power is the residual static electricity that remains in the computer even after it has been powered off and the battery is removed.

For your safety, and to protect the sensitive electronic components in your computer, you are requested to drain residual flea power before removing or replacing any components in your computer.

Draining residual flea power, also known as a performing a "hard reset", is also a common troubleshooting step if your computer does not turn on or boot into the operating system.

To drain residual flea power (perform a hard reset)

Steps

1. Turn off your computer.
2. Disconnect the power adapter from your computer.

3. Remove the [base cover](#).

NOTE: The battery must be disconnected from the system board (see Steps 1 to 2 in [Removing the battery](#)).

4. Press and hold the power button for 20 seconds to drain the flea power.

5. Install the [base cover](#).

6. Connect the power adapter to your computer.

7. Turn on your computer.

NOTE: For more information about performing a hard reset, see the knowledge base article [000130881](#) at www.dell.com/support.

Backup media and recovery options

It is recommended to create a recovery drive to troubleshoot and fix problems that may occur with Windows. Dell proposes multiple options for recovering Windows operating system on your Dell PC. For more information, see [Dell Windows Backup Media and Recovery Options](#).

Real Time Clock—RTC reset

The Real Time Clock (RTC) reset function allows you or the service technician to recover the recently launched model Dell Latitude and Precision systems from **No POST/No Boot/No Power** situations. You can initiate the RTC reset on the system from a power-off state only if it is connected to AC power. Press and hold the power button for 25 seconds. The system RTC reset occurs after you release the power button.

NOTE: If AC power is disconnected from the system during the process or the power button is held longer than 40 seconds, the RTC reset process gets aborted.

The RTC reset will reset the BIOS to Defaults, un-provision Intel vPro and reset the system date and time. The following items are unaffected by the RTC reset:

- Service Tag
- Asset Tag
- Ownership Tag
- Admin Password
- System Password
- HDD Password
- Key Databases
- System Logs

NOTE: The IT administrator's vPro account and password on the system will be un-provisioned. The system needs to go through the setup and configuration process again to reconnect it to the vPro server.

The below items may or may not reset based on your custom BIOS setting selections:



- Boot List
- Enable Legacy Option ROMs
- Secure Boot Enable
- Allow BIOS Downgrade

Getting help and contacting Dell

Self-help resources

You can get information and help on Dell products and services using these self-help resources:

Table 23. Self-help resources

Self-help resources	Resource location
Information about Dell products and services	www.dell.com
My Dell app	
Tips	
Contact Support	In Windows search, type <code>Contact Support</code> , and press Enter.
Online help for operating system	www.dell.com/support/windows
Access top solutions, diagnostics, drivers and downloads, and learn more about your computer through videos, manuals and documents.	Your Dell computer is uniquely identified by a Service Tag or Express Service Code. To view relevant support resources for your Dell computer, enter the Service Tag or Express Service Code at www.dell.com/support . For more information on how to find the Service Tag for your computer, see Locate the Service Tag on your computer .
Dell knowledge base articles for a variety of computer concerns	<ol style="list-style-type: none"> 1. Go to www.dell.com/support. 2. On the menu bar at the top of the Support page, select Support > Knowledge Base. 3. In the Search field on the Knowledge Base page, type the keyword, topic, or model number, and then click or tap the search icon to view the related articles.

Contacting Dell

To contact Dell for sales, technical support, or customer service issues, see www.dell.com/contactdell.

 **NOTE:** Availability varies by country/region and product, and some services may not be available in your country/region.

 **NOTE:** If you do not have an active Internet connection, you can find contact information about your purchase invoice, packing slip, bill, or Dell product catalog.